

DRAFT

USER'S GUIDE

BOXLIGHT SP-10t

 **BOXLIGHT**[®]
Presenting a Better Way





To the Owner

Before operating this projector, read this manual thoroughly and operate the projector properly.

This projector provides many convenient features and functions. Operating the projector properly enables you to manage those features and maintains it in better condition for a considerable time.

Improper operation may result in not only shortening the product-life, but also malfunctions, fire hazard, or other accidents.

If your projector seems to operate improperly, read this manual again, check operations and cable connections and try the solutions in the "Troubleshooting" section at the end of this booklet. If the problem still persists, contact BOXLIGHT.

	CAUTION RISK OF ELECTRIC SHOCK DO NOT OPEN	
CAUTION : TO REDUCE THE RISK OF ELECTRIC SHOCK, DO NOT REMOVE COVER (OR BACK). NO USER-SERVICEABLE PARTS INSIDE EXCEPT LAMP REPLACEMENT. REFER SERVICING TO QUALIFIED SERVICE PERSONNEL.		
	THIS SYMBOL INDICATES THAT DANGEROUS VOLTAGE CONSTITUTING A RISK OF ELECTRIC SHOCK IS PRESENT WITHIN THIS UNIT.	
	THIS SYMBOL INDICATES THAT THERE ARE IMPORTANT OPERATING AND MAINTENANCE INSTRUCTIONS IN THE OWNER'S MANUAL WITH THIS UNIT.	



Safety Precaution

WARNING : TO REDUCE THE RISK OF FIRE OR ELECTRIC SHOCK, DO NOT EXPOSE THIS APPLIANCE TO RAIN OR MOISTURE.

- This projector produces intense light from the projection lens. Do not stare directly into the lens as possible. Eye damage could result. Be especially careful that children do not stare directly into the beam.
- Install the projector in a proper position. If not, it may result in a fire hazard.
- Take appropriate space on the top, sides and rear of the projector cabinet for allowing air circulation and cooling the projector. Minimum distance should be taken. If the projector is to be built into a compartment or similarly enclosed, the minimum distances must be maintained. Do not cover the ventilation slot on the projector. Heat build-up can reduce the service life of your projector, and can also be dangerous.

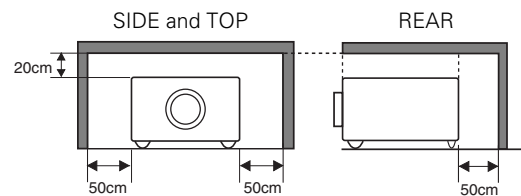

- Do not put any flammable object or spray can near the projector, hot air is exhausted from the ventilation holes.
- If the projector is not to be used for an extended time, unplug the projector from the power outlet.

READ AND KEEP THIS OWNER'S MANUAL FOR LATER USE.

CAUTION

Not for use in a computer room as defined in the Standard for the Protection of Electronic Computer/Data Processing Equipment, ANSI/NFPA 75.

Ne puet être utilisé dans une salle d'ordinateurs telle que définie dans la norme ANSI/NFPA 75 Standard for Protection of Electronic Computer/Data Processing Equipment

Safety Instructions

All the safety and operating instructions should be read before the product is operated.

Read all of the instructions given here and retain them for later use. Unplug this projector from AC power supply before cleaning. Do not use liquid or aerosol cleaners. Use a damp cloth for cleaning.

Follow all warnings and instructions marked on the projector.

For added protection to the projector during a lightning storm, or when it is left unattended and unused for long periods of time, unplug it from the wall outlet. This will prevent damage due to lightning and power line surges.

Do not expose this unit to rain or use near water... for example, in a wet basement, near a swimming pool, etc...

Do not use attachments not recommended by the manufacturer as they may cause hazards.

Do not place this projector on an unstable cart, stand, or table. The projector may fall, causing serious injury to a child or adult, and serious damage to the projector. Use only with a cart or stand recommended by the manufacturer, or sold with the projector. Wall or shelf mounting should follow the manufacturer's instructions, and should use a mounting kit approved by the manufacturers.

An appliance and cart combination should be moved with care. Quick stops, excessive force, and uneven surfaces may cause the appliance and cart combination to overturn.



Slots and openings in the back and bottom of the cabinet are provided for ventilation, to insure reliable operation of the equipment and to protect it from overheating.

The openings should never be covered with cloth or other materials, and the bottom opening should not be blocked by placing the projector on a bed, sofa, rug, or other similar surface. This projector should never be placed near or over a radiator or heat register.

This projector should not be placed in a built-in installation such as a book case unless proper ventilation is provided.

Never push objects of any kind into this projector through cabinet slots as they may touch dangerous voltage points or short out parts that could result in a fire or electric shock. Never spill liquid of any kind on the projector.

Do not install the projector near the ventilation duct of air-conditioning equipment.

This projector should be operated only from the type of power source indicated on the marking label. If you are not sure of the type of power supplied, consult your authorized dealer or local power company.

Do not overload wall outlets and extension cords as this can result in fire or electric shock. Do not allow anything to rest on the power cord. Do not locate this projector where the cord may be damaged by persons walking on it.

Do not attempt to service this projector yourself as opening or removing covers may expose you to dangerous voltage or other hazards. Refer all servicing to qualified service personnel.

Unplug this projector from wall outlet and refer servicing to qualified service personnel under the following conditions:

- a. When the power cord or plug is damaged or frayed.
- b. If liquid has been spilled into the projector.
- c. If the projector has been exposed to rain or water.
- d. If the projector does not operate normally by following the operating instructions. Adjust only those controls that are covered by the operating instructions as improper adjustment of other controls may result in damage and will often require extensive work by a qualified technician to restore the projector to normal operation.
- e. If the projector has been dropped or the cabinet has been damaged.
- f. When the projector exhibits a distinct change in performance-this indicates a need for service.

When replacement parts are required, be sure the service technician has used replacement parts specified by the manufacturer that have the same characteristics as the original part. Unauthorized substitutions may result in fire, electric shock, or injury to persons.

Upon completion of any service or repairs to this projector, ask the service technician to perform routine safety checks to determine that the projector is in safe operating condition.

Voor de klanten in Nederland



Bij dit product zijn batterijen geleverd. Wanneer deze leeg zijn, moet u ze niet weggooien maar inleveren als KCA.

Safety Instruction

Air Circulation

Openings in the cabinet are provided for ventilation and to ensure reliable operation of the product and to protect it from overheating, and these openings must not be blocked or covered.

CAUTION

Hot air is exhausted from the exhaust vent. When using or installing the projector, the following precautions should be taken.

- Do not put any flammable objects near the vent.
- Keep the exhaust vent at least 3'(1m) away from any objects.
- Do not touch a peripheral part of the exhaust vent, especially screws and metallic part. This area will become hot while the projector is being used.
- Do not put anything on the cabinet. The materials put on the cabinet will not only get damaged but also cause fire hazard by heat.

Cooling fans are provided to cool down the projector. This projector monitors internal temperature and control the running speed of the cooling fans.

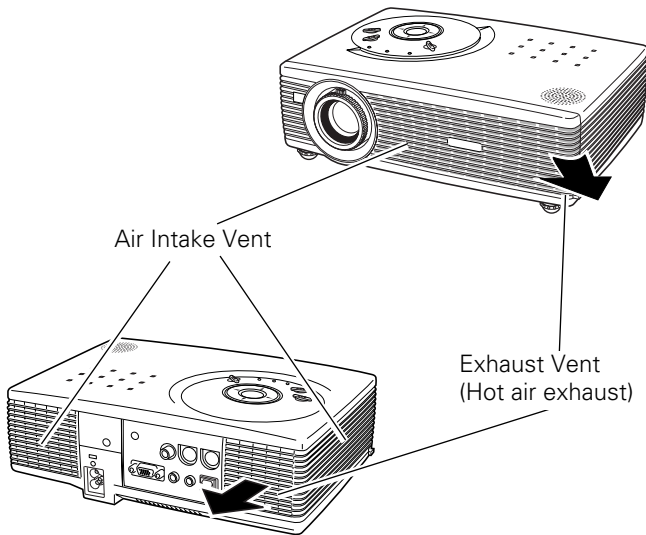

Installing the Projector in Proper Position

Install the projector properly. Improper Installation may reduce the lamp lifetime and cause a fire hazard.

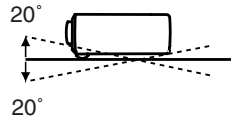

Do not tilt the projector more than 20 degrees to either side.



NO UPWARD

Do not point the projector up to project an image.



NO DOWNWARD

Do not point the projector down to project an image.



NO SIDEWARD

Do not put the projector on either side to project an image.

Moving the Projector

When moving the projector, replace the Lens Cover and retract Adjustable Feet to prevent damage to the lens and cabinet.

When the projector is not in use for an extended period, put it into the case (carrying bag) supplied with the projector.

CAUTION

Carrying Bag (supplied) is intended for protection from dust and scratches on the surface of a cabinet, and it is not designed to protect an appliance from external forces. Do not transport a projector through a courier or transport services with this bag, otherwise the projector can be damaged. When handling a projector, do not drop, bump, subject it to strong forces or put other things on the cabinet.

CAUTION IN CARRYING OR TRANSPORTING THE PROJECTOR

- Do not drop or bump a projector, otherwise damages or malfunctions may result.
- When carrying a projector, use a suitable carrying case.
- Do not transport a projector by using a courier or transport service in an unsuitable transport case. This may cause damage to a projector. To transport a projector through a courier or transport service, consult your Boxlight dealer for best way.

Compliance

Federal Communication Commission Notice

Note : This equipment has been tested and found to comply with the limits for a Class B digital device, pursuant to part 15 of the FCC Rules. These limits are designed to provide reasonable protection against harmful interference in a residential installation. This equipment generates, uses and can radiate radio frequency energy and, if not installed and used in accordance with the instructions, may cause harmful interference to radio communications. However, there is no guarantee that interference will not occur in a particular installation. If this equipment does cause harmful interference to radio or television reception, which can be determined by turning the equipment off and on, the user is encouraged to try to correct the interference by one or more of the following measures :

- Reorient or relocate the receiving antenna.
- Increase the separation between the equipment and receiver.
- Connect the equipment into an outlet on a circuit different from that to which the receiver is connected.
- Consult the dealer or an experienced radio/TV technician for help.

Use of shielded cable is required to comply with class B limits in Subpart B of Part 15 of FCC Rules.

Do not make any changes or modifications to the equipment unless otherwise specified in the instructions. If such changes or modifications should be made, you could be required to stop operation of the equipment.

Model Number : BOXLIGHT SP-10t
Trade Name : Boxlight
Responsible party : BOXLIGHT
Address : 19332 Powder Hill Place Poulosbo,
WA 98370-7407 USA
Telephone No. : (800)762-5757 or +1-360-779-7901

Model Number : TGX0043-011010 (1AV4U20B69000)
IR Presentation Remote Receiver for Projector
Trade Name : HOSIDEN
Responsible Party : Hosiden America Corp.
Address : 120 East State Parkway, Schaumburg, IL, 60173
Telephone No. : (847)885-8870

AC Power Cord Requirement

The AC Power Cord supplied with this projector meets the requirement for use in the country you purchased it.

AC Power Cord for the United States and Canada :

AC Power Cord used in the United States and Canada is listed by the Underwriters Laboratories (UL) and certified by the Canadian Standard Association (CSA).

AC Power Cord has a grounding-type AC line plug. This is a safety feature to be sure that the plug will fit into the power outlet. Do not try to defeat this safety feature. Should you be unable to insert the plug into the outlet, contact your electrician.

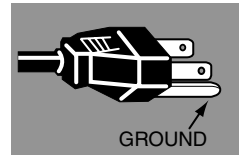

THE SOCKET-OUTLET SHOULD BE INSTALLED NEAR THE EQUIPMENT AND EASILY ACCESSIBLE.

Table of Contents

To the Owner	2	Computer Input	22
Safety Instructions	3	Input Source Selection	22
Compliance	5	Computer System Selection	23
Table of Contents	6	PC Adjustment	24
Features and Design	7	Auto PC Adjustment	24
Overview	8	Manual PC Adjustment	25
Front	8	Image Level Selection	27
Back	8	Image Level Adjustment	28
Bottom	8	Screen Size Adjustment	29
Top panel	9	Video Input	30
Terminals	10	Input Source Selection (Video, S-Video)	30
Remote Control	11	Input Source Selection (Component, RGB Scart 21-pin) ..	31
Operating Range	11	Video System Selection	32
Preparation	12	Image Level Selection	33
Connecting the AC Power Cord	12	Image Level Adjustment	34
Positioning the Projector	13	Screen Size Adjustment	35
Adjustable Feet	13	Setting	36
Remote Control Battery Installation	14	Setting Menu	36
Attaching the Lens Cover	14	Using the Presentation Remote Control	39
Installation	15	Presentation Remote Control	39
Connecting to a Computer	15	Installation	39
Connecting to Video Equipment	16	Maintenance	40
Before Operation	17	Lamp Replacement	40
How to Operate the On-Screen Menu	17	Lamp Replace	40
Menu Bar	18	Lamp Replace Counter	41
Basic Operation	19	Warning Indicator	42
Turning On the Projector	19	Air Filter	43
Turning Off the Projector	19	Cleaning the Projection Lens	43
Adjusting the Screen	20	Appendix	44
Zoom Adjustment	20	Troubleshooting	44
Focus Adjustment	20	Indicators and Projector Condition	46
Keystone Adjustment	20	Menu Tree	47
Picture Freeze Function	20	Compatible Computer Specifications	49
No Show Function	21	Technical Specifications	50
P-Timer Function	21	Configuration of Terminals	51
Sound Adjustment	21	Optional Parts	51

TRADEMARKS

- Apple, Macintosh, and PowerBook are trademarks or registered trademarks of Apple Computer, Inc.
- IBM, VGA, XGA, and PS/2 are trademarks or registered trademarks of International Business Machines, Inc.
- Windows and PowerPoint are registered trademarks of Microsoft Corporation.
- Each name of corporations or products in the owner's manual is a trademark or a registered trademark of its respective corporation.

Features and Design

BOXLIGHT SP-10t is designed with the most advanced technology for portability, durability, and ease of use. This projector utilizes built-in multimedia features, a palette of 16.77 million colors, and matrix liquid crystal display (LCD) technology.

Greater Mobility

Extremely compact in size and weight. It is designed to be carried and work anywhere you wish to use.

Outstanding Compatibility

This projector widely accepts various video and computer input signals including;

– Computers

IBM-compatible or Macintosh computer up to 1280 x 1024 resolution.

– 6 Color Systems

NTSC, PAL, SECAM, NTSC 4.43, PAL-M or PAL-N color system can be connected.

– Component Video

Component video signal, such as a DVD player output, high definition TV signals including 480i, 480p, 575i, 575p, 720p, 1035i or 1080i, can be connected.

– S-Video

S-Video signal, such as a S-VHS VCR output signal, can be connected.

– RGB Scart

RGB Scart signal can be connected.

Superb Image Quality

Supports 800 x 600 dots resolution for computer input. Resolution from a computer between SVGA (800 x 600) and SXGA (1280 x 1024) is precisely compressed into 800 x 600 dots.

Multi-Scan System

This projector has Multi-Scan System to conform to almost all computer output signals quickly. No need for troublesome manual adjustment of frequency and other settings. ( P23)

Auto PC Adjustment

Incoming computer signals are recognized and the best adjustment is automatically set by Auto PC Adjustment. No complicated setup is necessary and projection is always precise. ( P24)

Digital Zoom (for Computer)

Digital Zoom function expands (to approx. 16 times of screen size) or compress the image size, allowing you to focus on crucial information at a presentation. ( P29)

Digital Keystone Adjustment

Positioning height of the projector may result in distorted image being displayed in a trapezoid shape. Keystone Adjustment solves this problem by digitally altering projection to produce undistorted images. ( P20, P36)



Interlace Progressive Conversion

High-quality picture is available with this technology which converts interlace signal into progressive signal. ( P35)

Multi-language Menu Display

Operation menu is displayed in; English, German, French, Italian, Spanish, Portuguese, Dutch, Swedish, Russian, Chinese, Korean or Japanese. ( P36)

User Logo

A projected image can be captured and used for the starting display of the projector. ( "Capture function" P36) You can also display the captured image in an interval during your presentation instead of blackout image. ( "No Show function" P21)

Power Management

Provided to reduce power consumption and maintain the lamp life. ( P37)

Key Lock Function

Provided to lock the operation of the projector. This function protects the projector from being tampered with by third persons. ( P38)

Presentation Remote Control

The provided Presentation Remote Control can be used as a wireless mouse to control the mouse cursor on the computer screen. This is extremely useful while giving presentations. ( P39)

Overview

Front

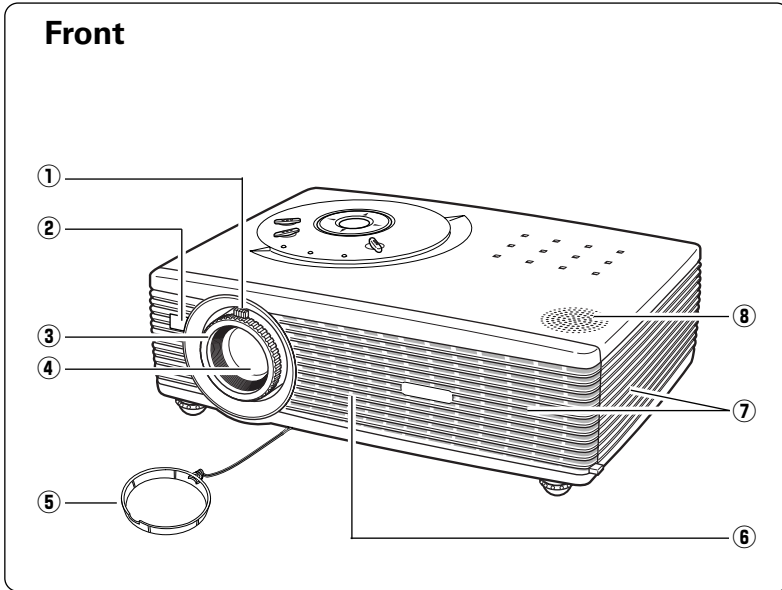

- ① **Zoom Lever** (P20)
- ② **Infrared Remote Receiver** (P11)
- ③ **Focus Ring** (P20)
- ④ **Projection Lens** (P43)
- ⑤ **Lens Cover**
- ⑥ **Air Intake Vent** (P43)
- ⑦ **Exhaust Vent**



Hot air is exhausted from the exhaust vent. Do not put heat-sensitive objects near this side.

- ⑧ **Speaker**

Back

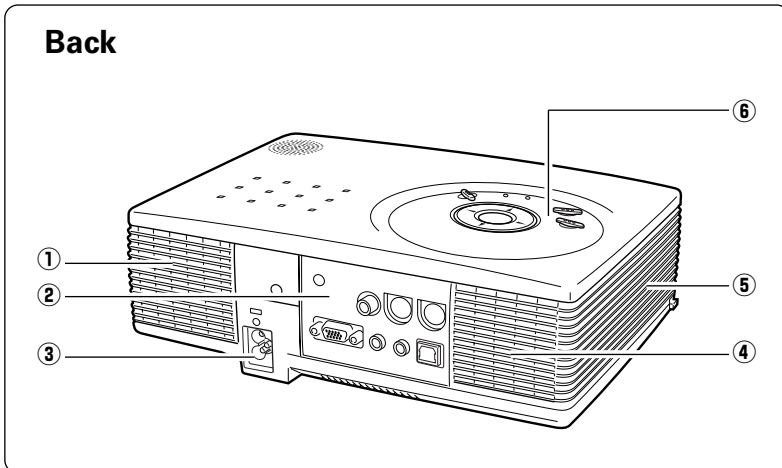

- ① **Air Intake Vent** (P43)
- ② **Terminals and Connectors** (P10, 15,16)
- ③ **Power Cord Connector** (P12)
- ④ **Exhaust Vent**



Hot air is exhausted from the exhaust vent. Do not put heat-sensitive objects near this side.

- ⑤ **Air Intake Vent** (P43)
- ⑥ **Top Controls and Indicators** (P9)

Bottom

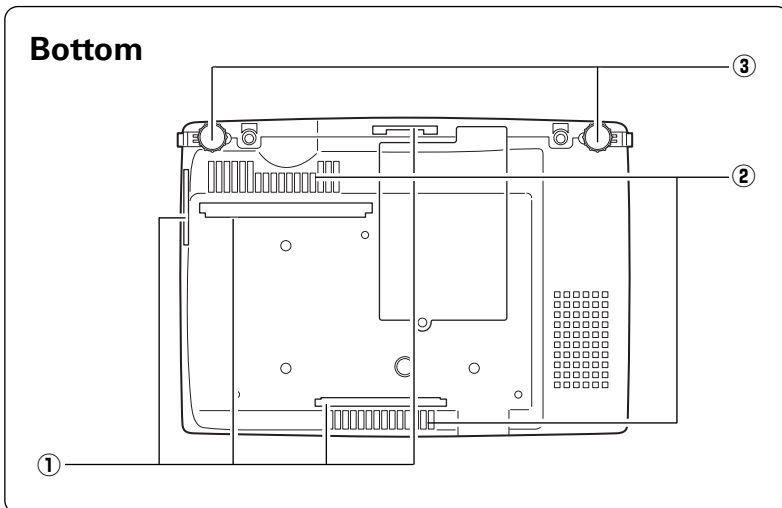

- ① **Air Filters**(P43)
- ② **Air Intake Vents** (P43)
- ③ **Adjustable Feet** (P14)



Hot air is exhausted from the exhaust vents. When using or installing the projector, the following precautions should be taken.

- Do not put any flammable objects near these vents.
- Keep front grills at least 3'(1m) away from any objects, especially heat-sensitive objects.
- Do not touch this area, especially screws and metallic part. This area will become hot while the projector is being used.

This projector detects internal temperature and will automatically adjust the running speed of the cooling fans.

Top panel

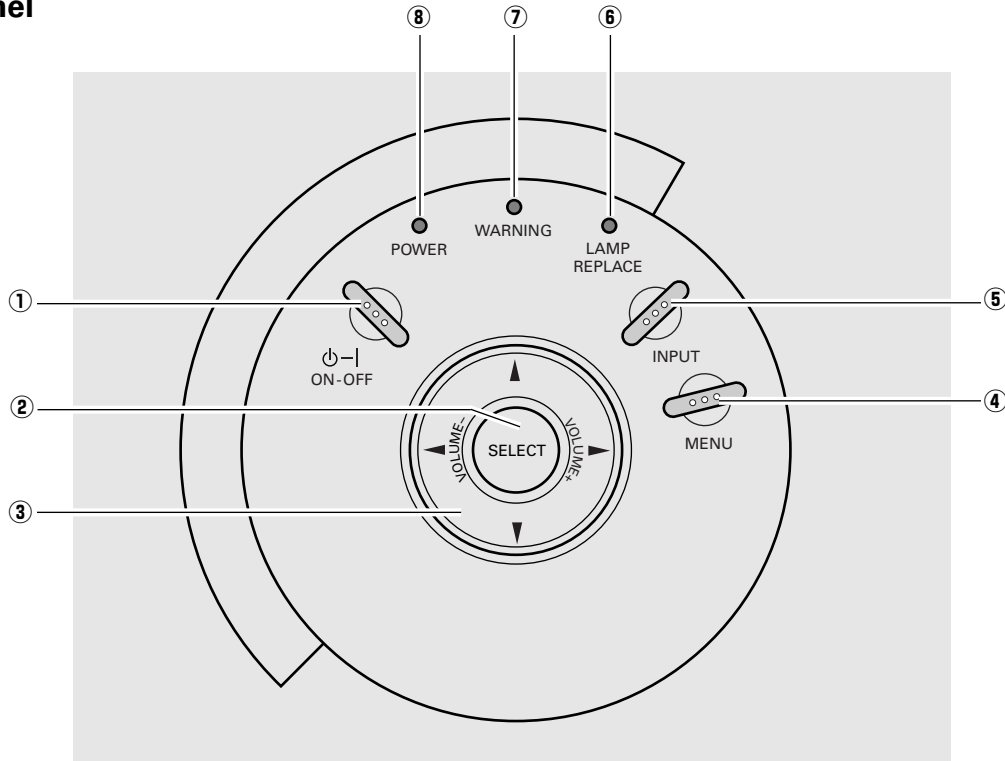

1 POWER ON-OFF button

Turns the projector on or off. (P19)

2 SELECT button

- Executes the selected item. (P17)
- Expands / compresses the image in Digital Zoom mode. (P29)

3 Point ▲▼◀▶ (VOLUME +/-) buttons

- Select an item or adjust value in the On-Screen Menu. (P17)
- Pan the image in DIGITAL ZOOM +/- mode. (P29)
- Adjust volume level. (Point ◀▶ buttons) (P21)

4 MENU button

Opens or closes the On-Screen Menu. (P17)

5 INPUT button

Selects input source. (P22,P30)

6 LAMP REPLACE indicator

Turns yellow when the life of the projection lamp draws to an end. (P40)

7 WARNING indicator

Lights red when the projector is in the abnormal condition. This indicator also flashes red when the internal projector temperature goes up over the operating range. (P42)

8 POWER indicator

Flashes red until the projector gets ready to be turned on. It turns red when the projector is in the stand-by mode. It remains green while the projector is in operation. (P19,37,42)

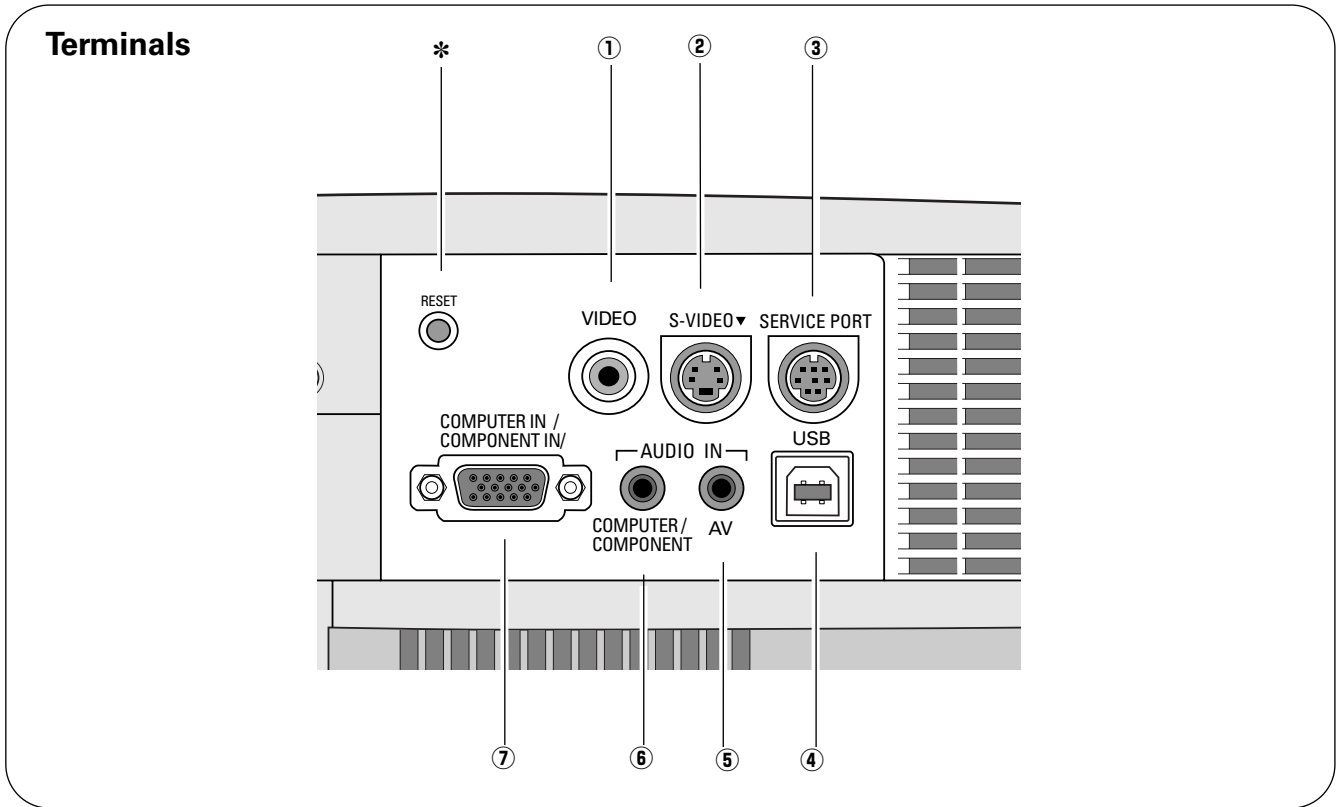

① VIDEO

Connect the composite video output from video equipment. (P16)

② S-VIDEO

Connect S-video output from video equipment. (P16)

③ SERVICE PORT

This jack is used to service this projector.

④ USB

Connect the USB port of your computer to this port when you wish to use the PAGE ▲▼ buttons on the remote control to scroll back and forth pages on the screen of the connected computer. (P15, P38)

⑤ AUDIO IN AV

Connect audio output from video equipment. (P16)

⑥ AUDIO IN COMPUTER/ COMPONENT

Connect audio output from a computer or component to this jack. (P15, P16)

⑦ COMPUTER IN / COMPONENT IN

Connect computer output, component output or RGB Scart 21-pin video output to this connector. (P15, P16)

*** RESET button**

A microprocessor included in the projector may occasionally malfunction and need to be reset. If necessary, press this button with a sharp tool to restart the unit. Do not use it excessively.

Remote Control

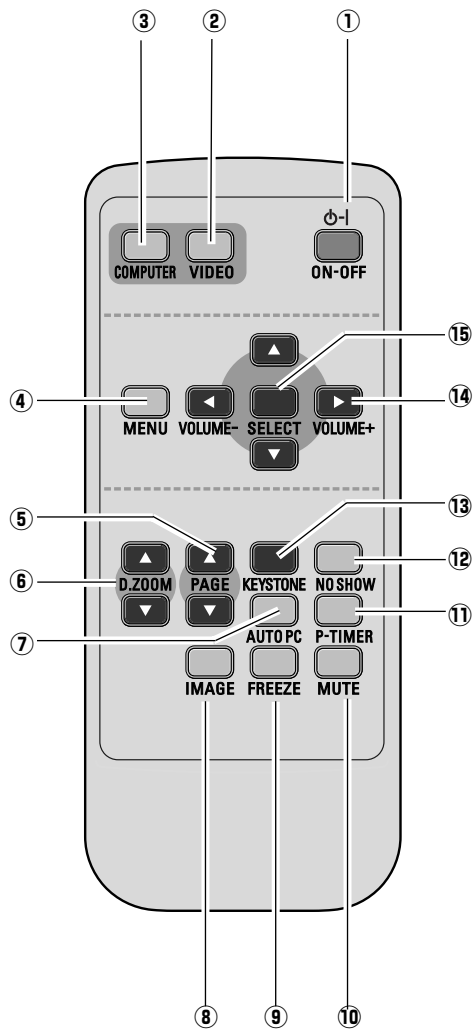

- ① **POWER ON-OFF button**
Turns the projector on or off. (P19)
- ② **VIDEO button**
Selects VIDEO input source. (P30)
- ③ **COMPUTER button**
Selects COMPUTER input source. (P22)
- ④ **MENU button**
Opens or closes the On-Screen Menu. (P17)
- ⑤ **PAGE ▲▼ button**
Scroll back and forth pages on the screen when giving a presentation. (P10, P38)
- ⑥ **D.ZOOM ▲▼ button**
Select the Digital zoom +/- mode and resize the image. (P29)
- ⑦ **AUTO PC button**
Automatically adjusts a computer image to its optimum setting. (P24)
- ⑧ **IMAGE button**
Selects image level. (P27, P33)
- ⑨ **FREEZE button**
Freezes the picture. (P20)
- ⑩ **MUTE button**
Mutes the sound. (P21)
- ⑪ **P-TIMER button**
Operates the P-timer function. (P21)
- ⑫ **NO SHOW button**
Temporarily turns off the image on the screen. (P21)
- ⑬ **KEYSTONE button**
Corrects the keystone distortion. (P20, P36)
- ⑭ **Point ▲▼◀▶ (VOLUME + / -) buttons**
 - Select an item or adjust value in the On-Screen Menu. (P17)
 - Pan the image in DIGITAL ZOOM +/- mode. (P29)
 - Adjust volume level. (Point Left/Right buttons)(P21)
- ⑮ **Select button**
 - Executes the selected item. (P17)
 - Expands / compresses the image in Digital Zoom mode. (P29)



To insure safe operation, please observe the following precautions :

- Do not bend, drop the remote control or expose Remote Control to moisture or heat.
- For cleaning, use soft dry cloth. Do not apply benzene, thinner, splay or any chemical material.

Operating Range

Point the remote control toward the projector (Receiver Window) when pressing any button. Maximum operating range for the remote control is about 16.4' (5m) and 60° in front of the projector.

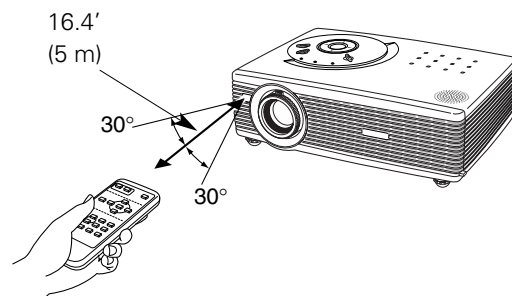

Preparation

Connecting the AC Power Cord

This projector uses nominal input voltages of 100-120 V or 200-240 V AC. This projector automatically selects the correct input voltage. It is designed to work with single-phase power systems having a grounded neutral conductor. To reduce risk of electrical shock, do not plug into any other type of power system. Consult your authorized dealer or service station if you are not sure of the type of power supply being in use. Connect a projector with a peripheral equipment before turning a projector on. (Refer to page 15 –16 for connection.)

CAUTION

For safety, unplug the AC Power Cord when an appliance is not used. When this projector is connected to the outlet with the AC Power Cord, an appliance is in Stand-by Mode and consumes a little electric power.

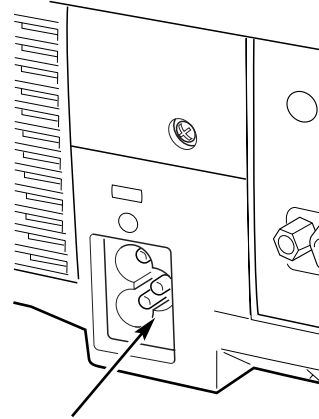

Connect AC Power Cord (supplied) to the projector. The AC outlet must be near this equipment and must be easily accessible.

Note:

The AC Power Cord must meet the requirements of the country where you use the projector. Confirm the AC plug type with the chart below. The proper AC power cord must be used. If the supplied AC Power Cord does not match the AC outlet, contact your sales dealer.

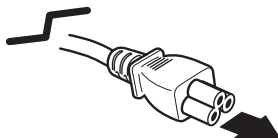
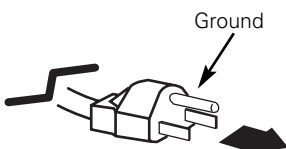
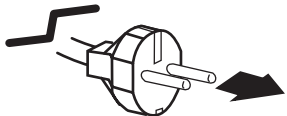
Projector side	AC Outlet side	
 <p data-bbox="337 1346 553 1415">To the POWER CORD CONNECTOR on the projector.</p>	<p data-bbox="630 1144 932 1171">For the U.S.A. and Canada</p>  <p data-bbox="764 1352 927 1402">To the AC Outlet. (120 V AC)</p>	<p data-bbox="1010 1144 1312 1171">For Continental Europe</p>  <p data-bbox="1138 1373 1321 1423">To the AC Outlet. (200 - 240 V AC)</p>

Positioning the Projector

- This projector is designed to project on a flat projection surface.
- The projector can be focused from 4.3'(1.3m) to 21.3'(6.5m).
- Refer to the figure below to adjust a screen size.

A : B = 9 : 1

Note:

The brightness in a room has a great influence on picture quality. It is recommended to limit ambient lighting in order to provide the best image.

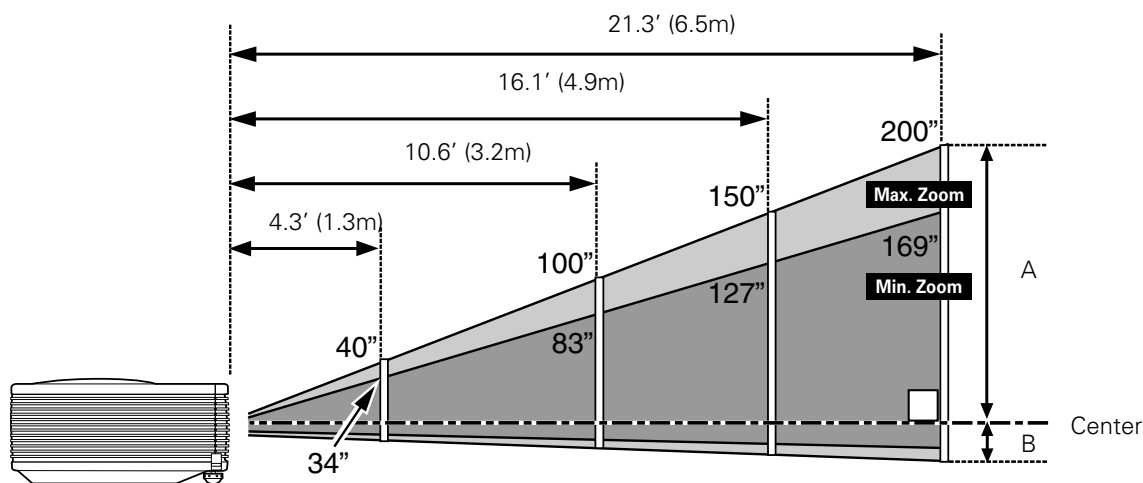

Screen Size (W x H) mm 4 : 3 aspect ratio	34"	40"	100"	150"	200"
Zoom (min)	4.3' (1.3m)	4.9' (1.5m)	12.5' (3.8m)	19.0' (5.8m)	—
Zoom (max)	—	4.3' (1.3m)	10.6' (3.2m)	16.1' (4.9m)	21.3' (6.5m)

Adjustable Feet

Picture tilt and projection angle can be adjusted by rotating the adjustable feet. Projection angle can be adjusted at 8.0 degrees.

- 1 Lift the front of the projector and pull the feet lock latches on the both sides of the projector.
- 2 Release the feet lock latches to lock the adjustable feet and rotate them to adjust position and tilt.
- 3 To retract the adjustable feet, lift the front of the projector and pull and undo the feet lock latches.
Keystone distortion of the projected image can be adjusted by Menu Operation. (P20 and P36)



CAUTION

Tilt the projector within the adjustable angle not to shorten the lamp life. Proper angle should be taken.

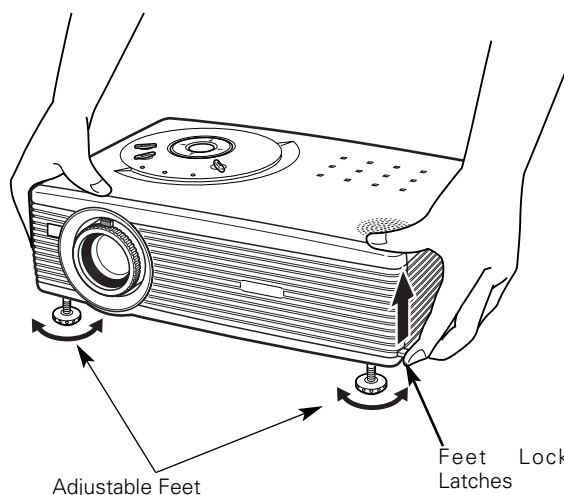

Remote Control Battery Installation

- 1** Remove the battery compartment lid.

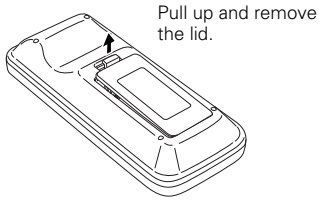

- 2** Slide the batteries into the compartment.

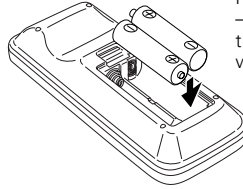

- 3** Replace the compartment lid.

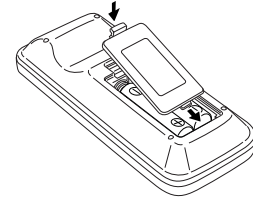

To insure safe operation, please observe the following precautions :

- Use (2) AAA, SUM-4 or R03 type alkaline batteries.
- Replace two batteries at the same time.
- Do not use a new battery with a used battery.
- Avoid contact with water or liquid.
- Do not expose the remote control to moisture, or heat.
- Do not drop the remote control.
- If a battery has leaked on remote control, carefully wipe case clean and install new batteries.
- Risk of explosion if battery is replaced by an incorrect type.
- Dispose of used batteries according to the instructions.

Attaching the Lens Cover

- 1** Thread the string through the hole on the lens cover and then tie a knot in the string to secure it in place.

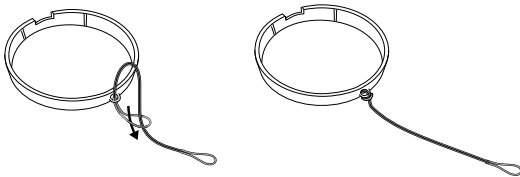

- 2** Thread the other end of the string through the hole at the bottom of the projector. Then pass the lens cover through the resulting loop of the string. Tie a knot in the string to secure it in place.

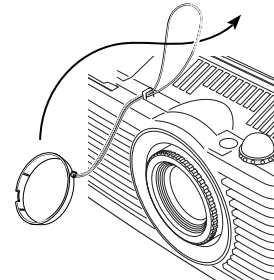

Installation

Connecting to a Computer

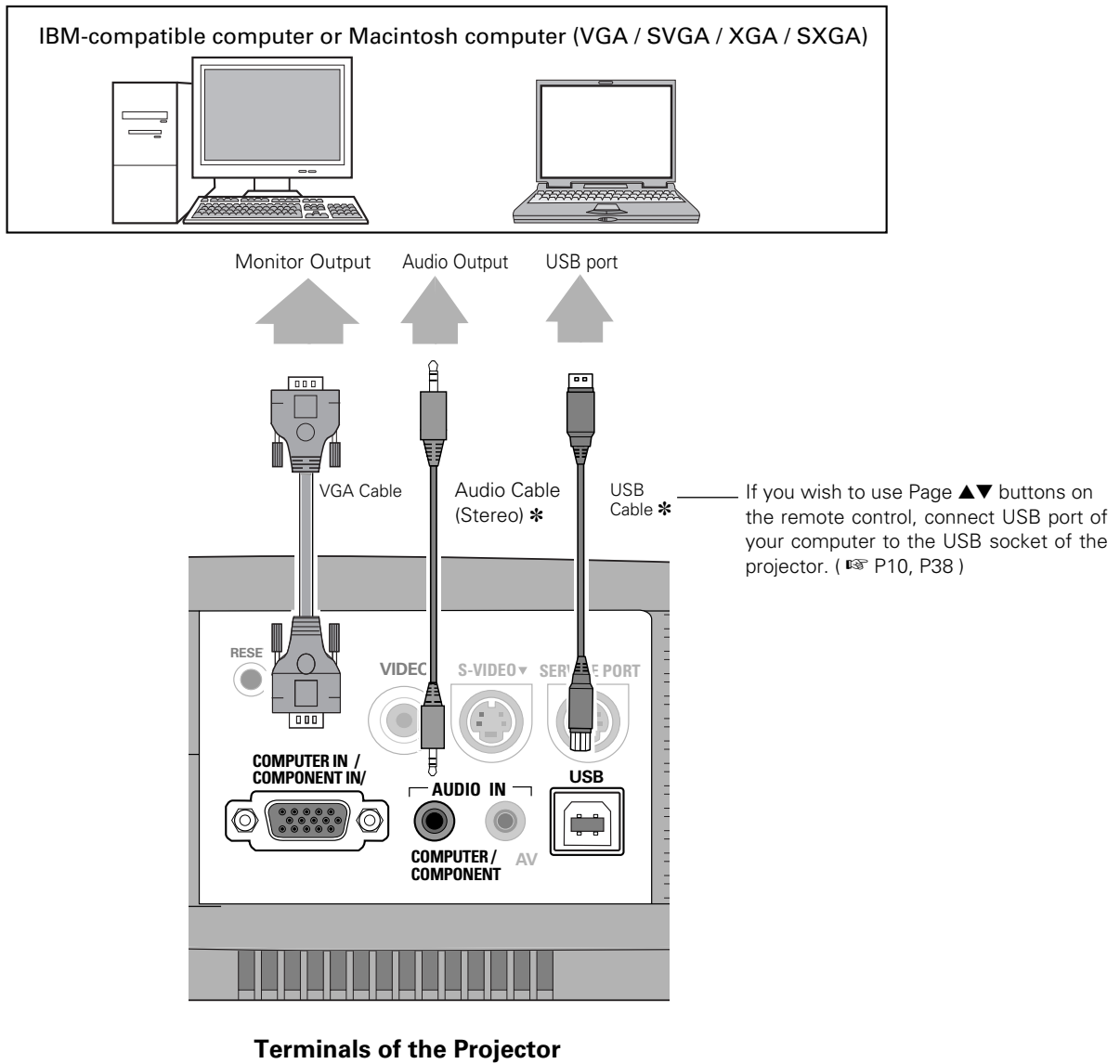

Note :

When connecting the cable, the power cords of both the projector and the external equipment should be disconnected from AC outlet. Turn the projector and peripheral equipment on before the computer is switched on.

Cables used for connection

- VGA Cable (HDB 15 pin)
- Audio Cable (Mini Plug (stereo)) *
- USB Cable *
- MAC Adapter (For Macintosh) *

* Not supplied.

◆ MAC ADAPTER (Not supplied)*

A Macintosh adapter may be required when you use a Macintosh computer.

Set switches as shown in the table below depending on RESOLUTION MODE that you want to use before you turn on projector and computer.

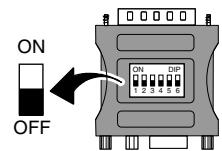

	1	2	3	4	5	6
13" MODE (640 x 480)	ON	ON	OFF	OFF	OFF	OFF
16" MODE (832 x 624)	OFF	ON	OFF	ON	OFF	OFF
19" MODE (1024 x 768)	OFF	ON	ON	OFF	OFF	OFF
21" MODE (1152 x 870)	ON	ON	ON	ON	OFF	OFF

Connecting to Video Equipment

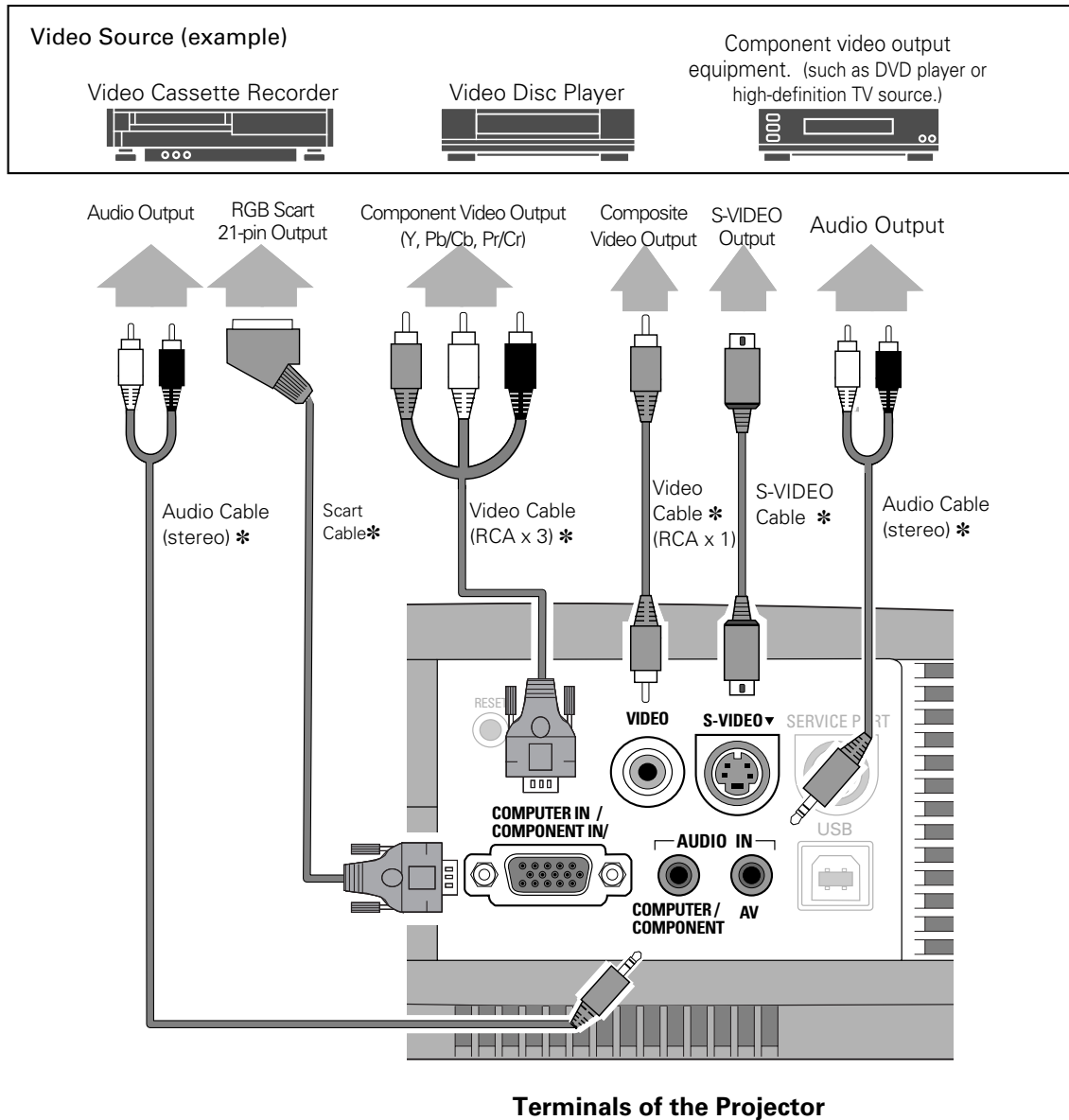

Cables used for connection

- Video Cable (RCA x 1) *
- S-VIDEO Cable *
- Audio Cables (Mini Plug) *
- Scart-VGA Cable *
- Component-VGA Cable *

* Not supplied.

Note :

The S-VIDEO jack has priority over the VIDEO jack under the condition of connecting both the S-VIDEO jack and the VIDEO jack when selecting AUTO in the Input Menu.



Note:

When connecting the cable, the power cords of both the projector and the external equipment should be disconnected from AC outlet.

Before Operation

How to Operate the On-Screen Menu

The projector can be adjusted or set via the On-Screen Menu. Refer to the following pages regarding each adjustment and setting procedure.

- 1 Press MENU button to display the On-Screen Menu.
- 2 Press Point ◀▶ buttons to select a Menu icon to adjust. Press Point ▲▼ buttons to select an item to adjust.
- 3 Press SELECT button to show the item data. Press Point ◀▶ buttons to adjust the data. Refer to the following pages for respective adjustment.

Note:

The selected item is not in effective until SELECT button is pressed.

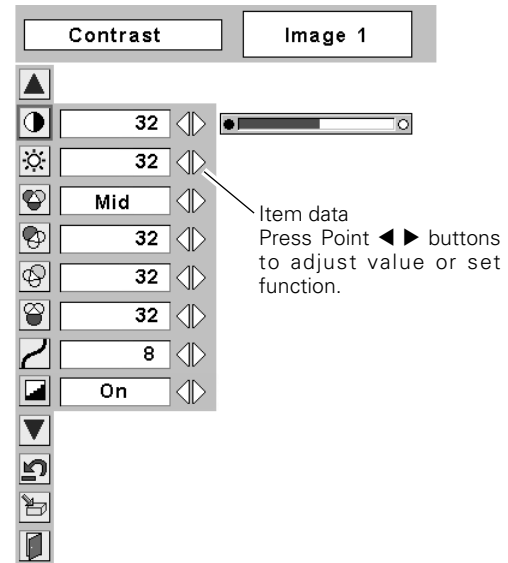
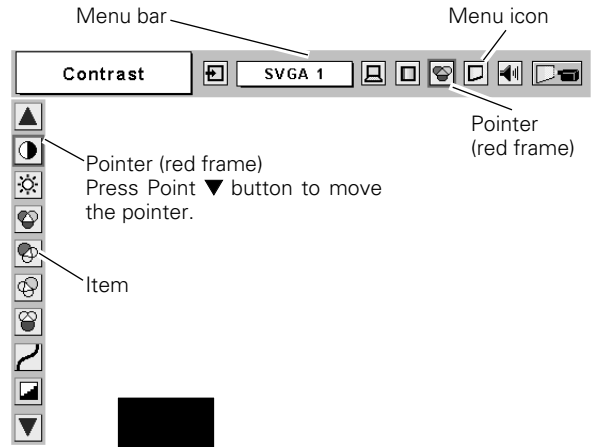

Remote Control

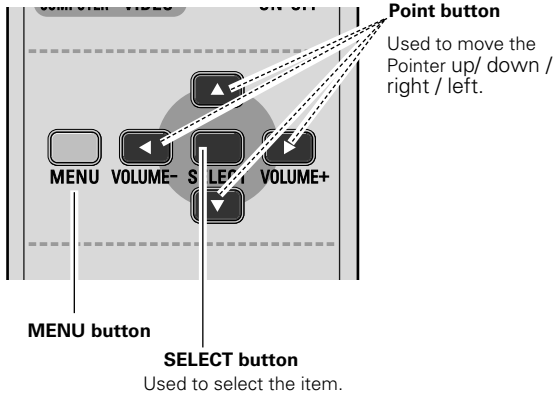

Top Control

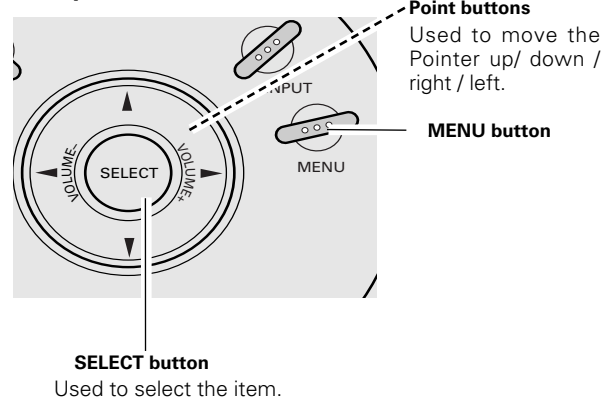

Menu Bar

For Computer Source

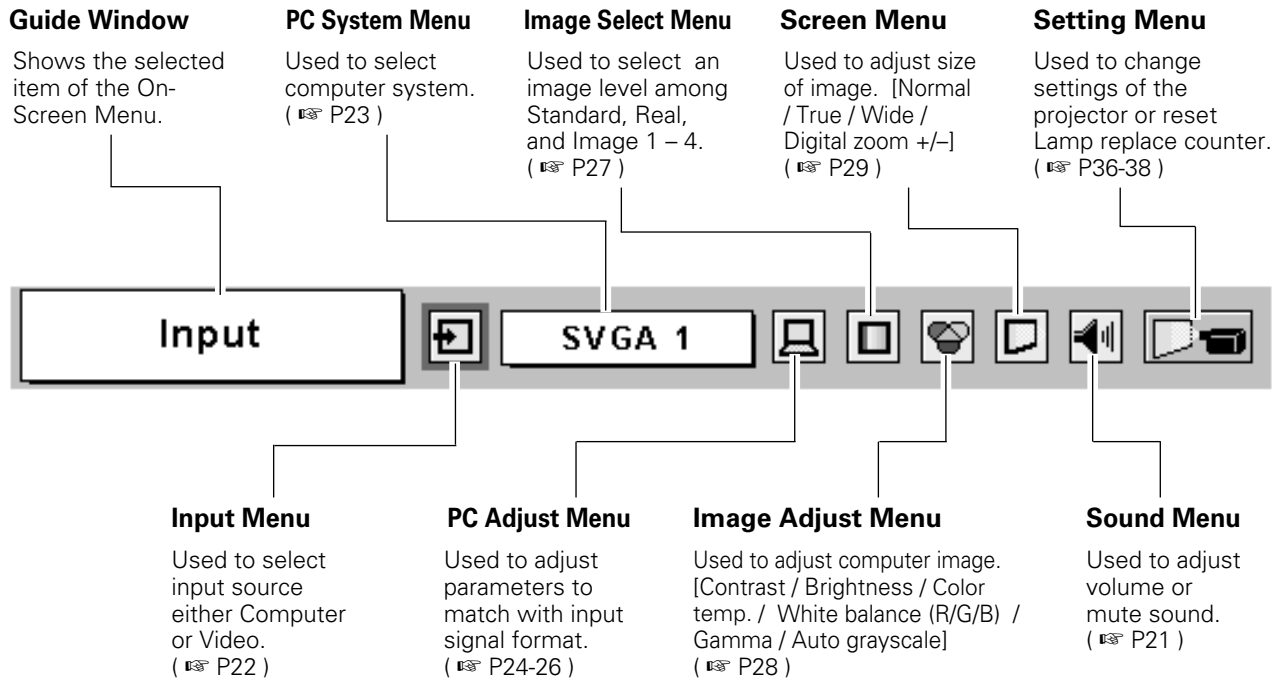

For video source

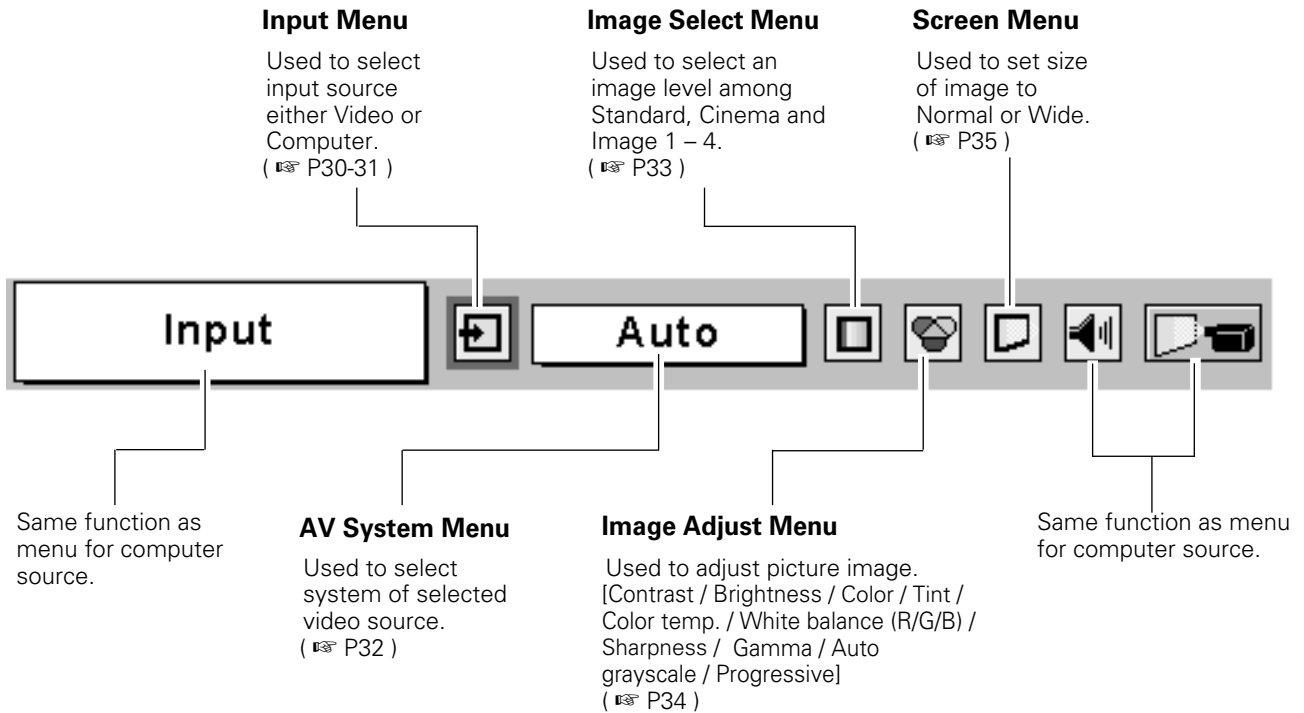

Basic Operation

Turning On the Projector

- 1 Complete peripheral connections (with a computer, VCR, etc.) before turning on the projector.
- 2 Connect the projector's AC Power Cord into an AC outlet. The POWER indicator flashes in a moment and then turns red.
- 3 Press POWER ON-OFF button on the top control or the remote control. The POWER Indicator turns green, and the cooling fans start to operate. The starting display appears on the screen and the count-down starts.
- 4 After the count-down, the input source that was selected last and the Lamp mode status appear on the screen.



- The starting display disappears after 30 seconds.
- The starting display can be changed. (" Capture " P36)

Selected Input Source and Lamp Mode

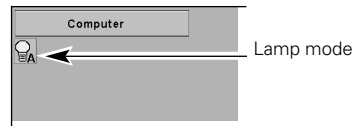

(" Lamp mode " P37)

Turning Off the Projector

- 1 Press the POWER ON-OFF button on the top control or the remote control, and the message " Power off? " appears on the screen.
- 2 Press the POWER ON-OFF button again to turn off the projector. The POWER indicator starts to flash red and continues while the cooling fans are operating. (for approx. 90 seconds)
- 3 When the projector is cooled down enough to be turned on again, the Power indicator turns red again. Then you can disconnect the AC power cord.

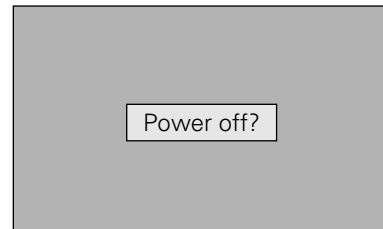

Message disappears after 4 seconds.



TO MAINTAIN THE LIFE OF LAMP, ONCE YOU TURN PROJECTOR ON, WAIT AT LEAST 5 MINUTES BEFORE TURNING IT OFF.
DO NOT DISCONNECT THE AC POWER CORD WHILE COOLING FANS ARE RUNNING OR BEFORE POWER INDICATOR LIGHTS RED. OTHERWISE IT WILL RESULT IN SHORTENING LAMP LIFE.

Note :

- When the Power Management function is ON, the projector detects signal interruption and automatically turns off the projection lamp. (P 37)
- The projector cannot be turned on during the cooling period with the POWER indicator flashing red. You can turn it on again after the POWER indicator lights red.
- Do not use the projector for more than 24 hours continuously. Turn off the projector at least once in 24 hours and give it a rest. Continuous use may result in shortening the lamp lifetime.
- This projector detects internal temperature and automatically controls the running speed of the cooling fans.
- If the WARNING indicator flashes or lights red, see "Warning Indicator" on page 42

Adjusting the Screen

Zoom Adjustment

Move the Zoom Lever upward / downward to zoom the image.

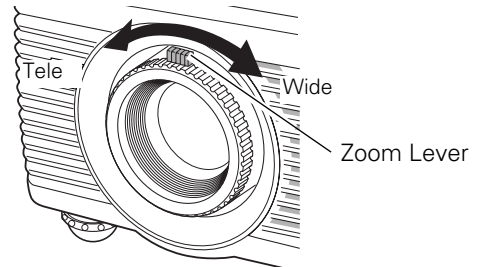

Focus Adjustment

Rotate the Focus ring to adjust the projected picture focus.

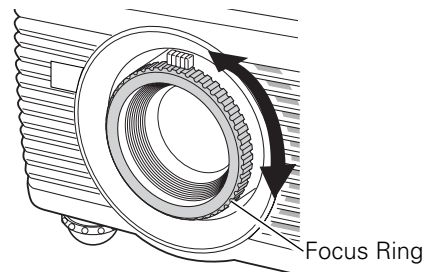

Keystone Adjustment

If a projected picture has keystone distortion, correct image with the keystone adjustment.

- 1 Press KEYSTONE button on the remote control or select Keystone on the Setting menu (P36) to display the Keystone dialog box.
- 2 Correct keystone distortion by pressing Point ▲▼ buttons. Press Point ▲ button to reduce the upper part of image, and press Point ▼ button to reduce the lower part.



- Arrows are white in no correction.
- The arrow of direction being corrected turns red.
- The arrow disappears at the maximum correction.
- If you press the KEYSTONE on the remote control once more while the keystone dialog box is being displayed, the adjustment will be canceled.

Reduce the upper width with Point ▲ button.

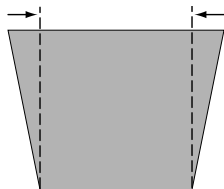

Reduce the lower width with Point ▼ button.

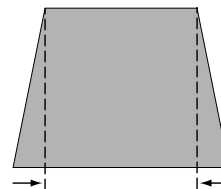

Picture Freeze Function

Press FREEZE button on the remote control to freeze the picture on-screen. To cancel the freeze function, press FREEZE button again or press any other button.

No Show Function

Press NO SHOW button on the remote control to black out the image. To restore to normal, press the NO SHOW button again or press any other button. When a projected image is captured and set as "User" in the Logo item in the Setting menu (P36), the screen changes each time you press the NO SHOW button as follows :

black out → the captured image → normal →……



Message disappears after 4 seconds.

P-Timer Function

Press P-Timer button on the remote control. The timer display "00 : 00" appears on the screen and the timer starts to count time (00 : 00 ~ 59 : 59).

To stop P-Timer display, press the P-TIMER button. And then, press P-TIMER button again to cancel P-Timer function.



Sound Adjustment

Direct Operation

Volume

Press VOLUME (+/-) button on the remote control or on the top control to adjust volume. The volume dialog box appears on the screen for a few seconds.

VOLUME (+) button to increase volume, and VOLUME (-) button for decreasing.

Mute

Press MUTE button on the remote control to cut off sound. To restore sound to its previous level, press MUTE button again or press Volume (+/-).

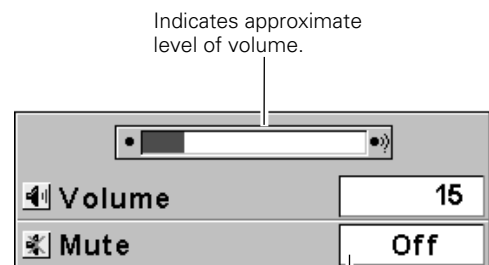

Indicates approximate level of volume.

Press MUTE button to set Mute function On or Off.

The display disappears after 4 seconds.

Menu Operation

1 Press MENU button to display the On-Screen Menu. Press Point ◀▶ buttons to move the red frame pointer to SOUND Menu icon.

2 Press Point ▼ button to move the red frame pointer to the item that you want to select, and then press SELECT button.

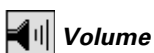

To increase volume, press Point ▶ button, and press Point ◀ button to decrease volume.



Press Point ◀▶ buttons to mute sound. Dialog box display is changed to "On" and sound is muted. To restore sound to its previous level, press Point ◀▶ buttons again.

SOUND MENU

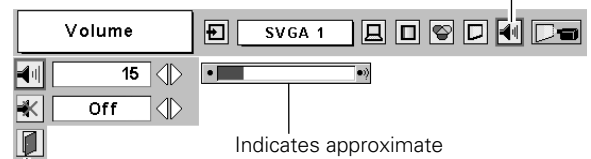

Sound Menu icon

Indicates approximate level of volume.

Close Sound Menu.

Computer Input

Input Source Selection

Direct Operation

Choose Computer by pressing INPUT button on the top control or COMPUTER button on the remote control.

Before using these buttons, correct input source should be selected through menu operation as described below.

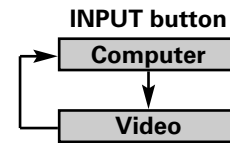

Menu Operation

- 1 Press the MENU button to display the On-Screen Menu. Press Point ◀▶ buttons to move the red frame pointer to INPUT Menu icon.
- 2 Press Point ▼ button to move the red arrow pointer to Computer and then press SELECT button. The Source Select Menu will appear.
- 3 Move the pointer to the correct input source and press SELECT button.

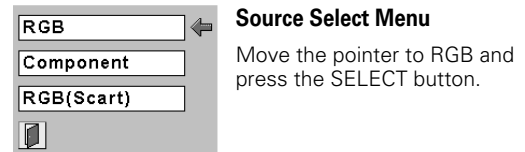
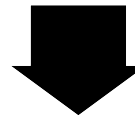
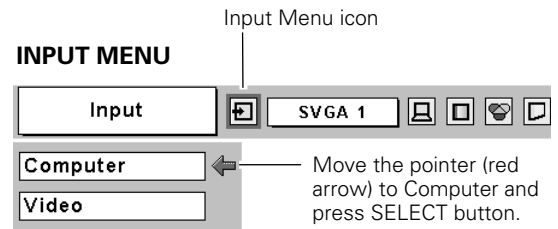

RGB When the input source is coming from a computer through the COMPUTER IN / COMPONENT IN terminal, select RGB.

Component " Selecting Input Source (Component / RGB-Scart 21-pin) " P31.

RGB (Scart) " Selecting Input Source (Component / RGB-Scart 21-pin) " P31.

Computer System Selection

This projector automatically tunes to various types of computers based on VGA, SVGA, XGA or SXGA with its Multi-scan system and Auto PC Adjustment. If Computer is selected as a signal source, this projector automatically detects the signal format and tunes to project a proper image without any additional setting. (Signal formats provided in this projector is shown on page 49)

Note : The projector may display one of the following messages.

- Auto**

When projector cannot recognize connected signal as PC system provided in this projector, Auto PC Adjustment function operates to adjust projector and the message "Auto" is displayed on System Menu icon. (P24.) When image is not provided properly, manual adjustment is required. (P25 - 26)
- There is no signal input from computer. Make sure the connection of computer and a projector is set correctly. (" Troubleshooting" P44)
- Mode 1**

User preset adjustment in Computer Adjustment. Adjustment data can be stored in Mode 1 - 5. (P25-26)
- SVGA 1**

Computer systems provided in the projector. The projector chooses a proper system and displays it.

*Mode 1 and SVGA 1 are examples.

Selecting Computer System Manually

PC system can be also selected manually.

- 1** Press MENU button to display the On-Screen Menu. Press Point ◀▶ buttons to move the red frame pointer to PC SYSTEM Menu icon.
- 2** Press Point ▼ button to move the red arrow pointer to the system that you want to set, and then press SELECT button.

PC SYSTEM MENU

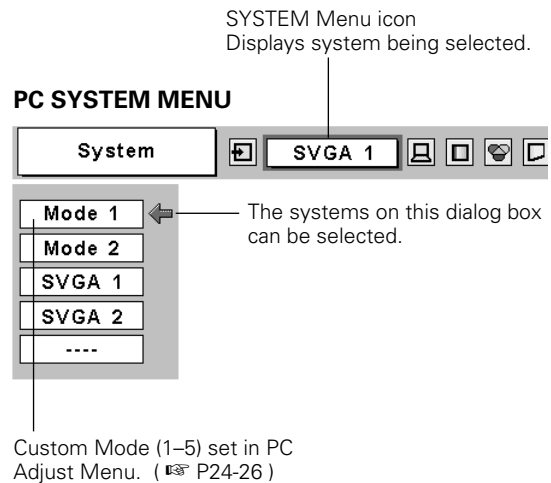
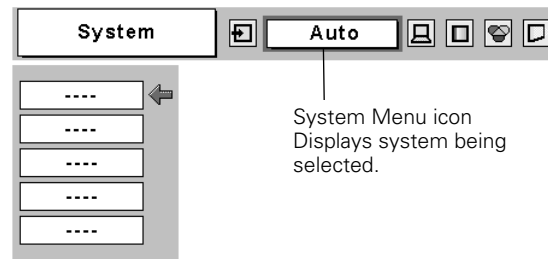

PC Adjustment

Auto PC Adjustment

Auto PC Adjustment function is provided to automatically conform Fine sync, Total dots and Picture Position to your computer. This function can be operated as follows.

Auto PC Adj.

- 1** Press the MENU button to display the On-Screen Menu. Press Point ◀▶ button to move the red frame pointer to PC Adjust Menu icon.
- 2** Press the Point ▼ button to move the red frame pointer to Auto PC Adj. icon and then press the SELECT button twice. This Auto PC Adjustment can be also executed by pressing the Auto PC button on the remote control.

To store adjustment parameters :

Adjustment parameters from Auto PC Adjustment can be memorized in this projector. Once parameters are memorized, the setting can be done just by selecting Mode in PC System Menu (P23). Refer to " Store " of Manual PC Adjustment section (P26).

Note :

- Fine sync, Total dots and Picture Position of some computers can not be fully adjusted with this Auto PC Adjustment function. When the image is not provided properly through this function, manual adjustments are required. (P25)
- Auto PC Adjustment function cannot be operated when "480p", "575p", "480i", "575i", "720p (HDTV)", "1035i (HDTV)" or "1080i (HDTV)" is selected on PC SYSTEM Menu (P23).

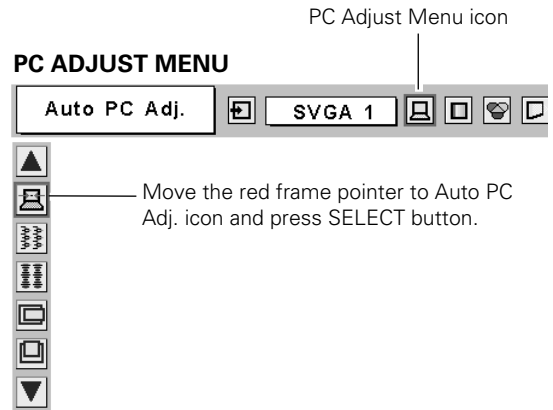

Manual PC Adjustment

Some computers employ special signal formats which may not be tuned by Multi-Scan system of this projector. In this case, the projector cannot reproduce a proper image and the image may be recognized as a flickering picture, a non-synchronized picture, a non-centered picture or a skewed picture.

The Manual PC Adjustment function allows you to precisely adjust several parameters to match those special signal formats. You can store those adjusted parameters in the 5 independent memory areas, enabling you to call up whenever you need.

1 Press MENU button to display the On-Screen Menu. Press Point ◀▶ buttons to move the red frame pointer to PC Adjust Menu icon.

2 Press Point ▼ button to move the red frame pointer to the item that you want to adjust and then press SELECT button. Adjustment dialog box will appear. Press Point ◀▶ buttons to adjust value.



Fine sync

Adjusts an image as necessary to eliminate flicker from the display. Press Point ◀▶ buttons to adjust value. (From 0 to 31.)



Total dots

Adjusts the number of total dots in one horizontal period. Press Point ◀▶ buttons and adjust number to match your PC image.



Horizontal

Adjusts horizontal picture position. Press Point ◀▶ buttons to adjust the position.



Vertical

Adjusts vertical picture position. Press Point ◀▶ buttons to adjust the position.



Current mode

Press SELECT button to show the information of computer selected.



Clamp

Adjusts clamp level. When the image has a dark bar(s), try this adjustment.

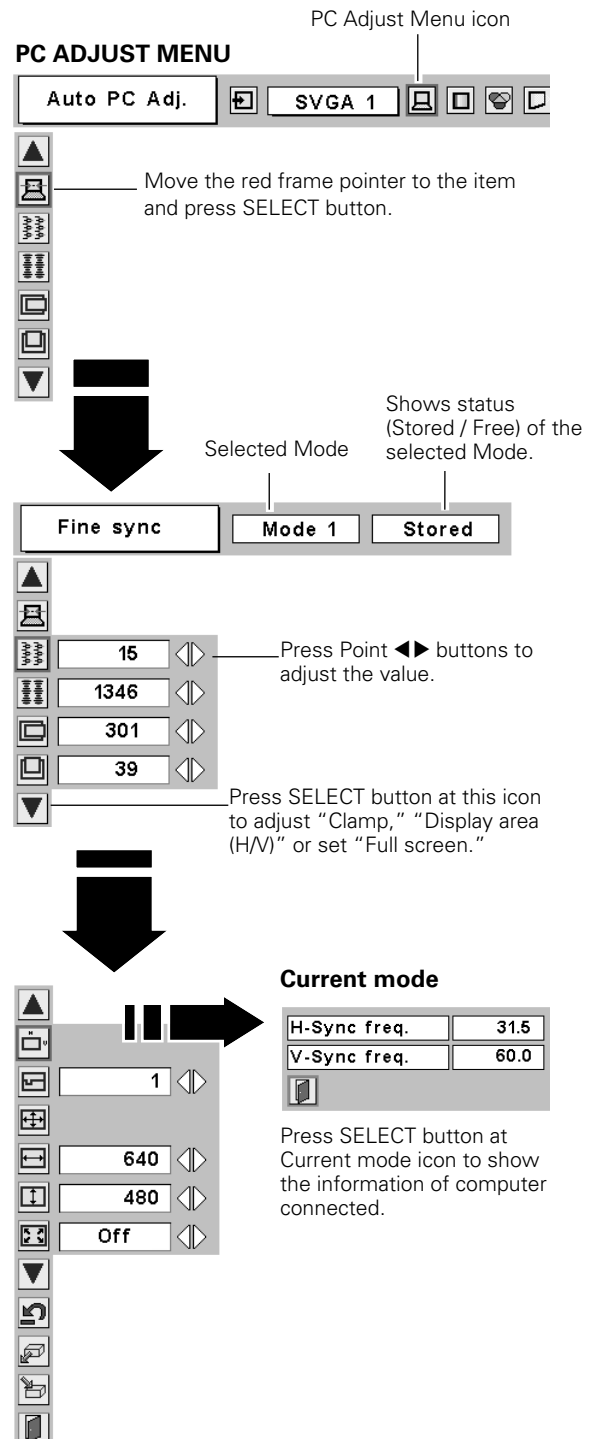

Display area

Selects area displayed with this projector. Select the resolution at Display area dialog box.

Display area H

Adjustment of horizontal area displayed with this projector. Press Point ◀▶ buttons to decrease/increase value to match the resolution of image. Then press the SELECT button.

Display area V

Adjustment of vertical area displayed with this projector. Press Point ◀▶ buttons to decrease / increase value to match the resolution of image. Then press the SELECT button.

Full screen

Press Point ◀▶ buttons to switch Full screen function to "On" or "Off." Set "On" to resize the image with 4 x 3 aspect ratio to fit the screen.

Note :

Display area, Display area (H/V) and Full screen cannot be adjusted when "480p", "575p", "480i", "575i", "720i (HDTV)", "1035i (HDTV)" or "1080i (HDTV)" is selected on PC SYSTEM Menu (P23).

Reset

Reset all adjust parameters on adjustment dialog box to previous figure.

Mode free

To clear adjustment parameters previously set, move the red frame pointer to Mode free icon and then SELECT button. Move the red arrow pointer to the Mode that you want to clear and then press SELECT button.

Store

To store adjustment parameters, move the red frame pointer to Store icon and then press SELECT button. Move the red arrow pointer to any of Mode 1 to 5 that you want to store to and then press SELECT button.

Quit

Closes PC Adjust Menu.

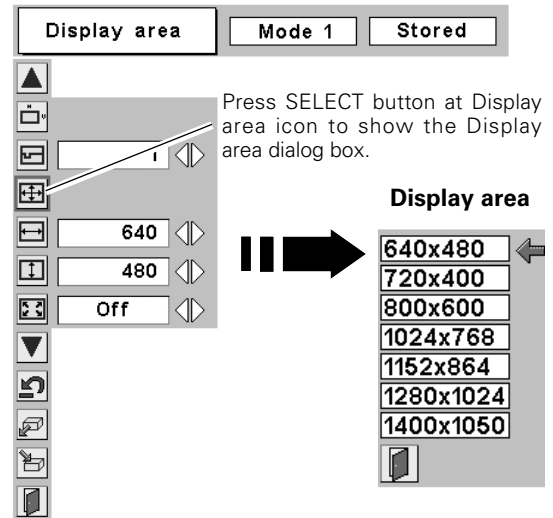

To clear adjustment data

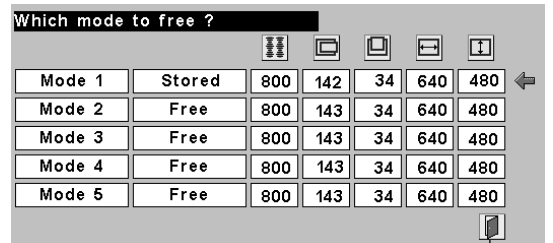

Close this dialog box.

To store adjustment data

This Mode has parameters being stored.

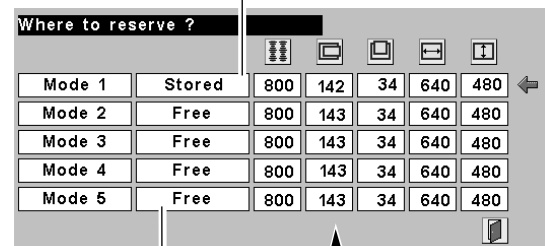

Vacant Mode

Shows values of "Total dots," "Horizontal," "Vertical," "Display area H," and "Display area V."

Image Level Selection

Direct Operation

Select image level among Standard, Real, Image 1, Image 2, Image 3 and Image 4 by pressing IMAGE button on the remote control.

Standard

Normal picture adjustment preset on this projector.

Real

Picture adjustment improved in reproduction of halftones. This adjustment is suitable for providing better image in brighter place.

Image 1~4

User preset picture adjustment in Image Adjust Menu (P28).

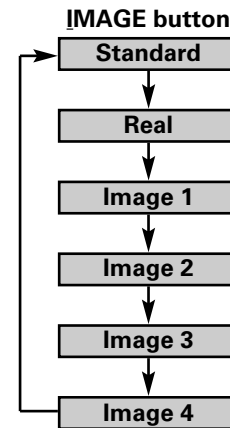

Menu Operation

- 1 Press MENU button to display the On-Screen Menu. Press Point ◀▶ button to move the red frame pointer to Image Select Menu icon.
- 2 Press Point ▼ button to move the red frame pointer to the level that you want to set and then press SELECT button.

Standard

Normal picture adjustment preset on this projector.

Real

Picture adjustment improved in reproduction of halftones. This adjustment is suitable for providing better image in brighter place.

Image 1~4

User preset picture adjustment in Image Adjust Menu (P28).

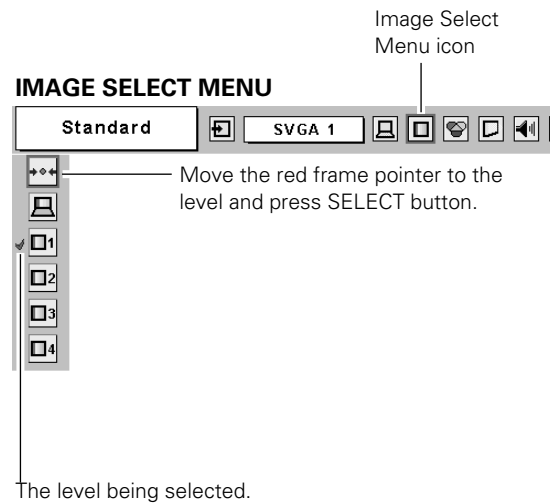

Image Level Adjustment

- 1 Press MENU button to display the On-Screen Menu. Press Point ◀▶ buttons to move the red frame pointer to Image Adjust Menu icon.
- 2 Press Point ▼ button to move the red frame pointer to the item that you want to adjust. and then press SELECT button. The level of each item is displayed. Adjust each level by pressing Point ◀▶ buttons.



Contrast

Press Point ◀▶ buttons to adjust the image contrast. (From 0 to 63.)



Brightness

Press Point ◀▶ buttons to adjust the image brightness. (From 0 to 63.)



Color temp.

Press Point ◀▶ buttons to select the Color temp. level that you want to select. (XLow, Low, Mid, or High)



White balance (Red)

Press Point ◀▶ buttons to adjust the red tone. (From 0 to 63.)



White balance (Green)

Press Point ◀▶ buttons to adjust the green tone. (From 0 to 63.)



White balance (Blue)

Press Point ◀▶ buttons to lighten the blue tone. (From 0 to 63.)



Gamma

Press Point ◀▶ buttons to obtain better balance of contrast. (From 0 to 15.)



Auto grayscale

When this function is "ON", it automatically enhances contrast of bright and dark part of image.



Reset

Reset all adjustment to previous figure.



Store

To store manually preset image, move the red frame pointer to Store icon and press SELECT button. The Image Level Menu will appear. Move the red frame pointer to the Image 1 to 4 where you want to set and then press SELECT button.



Quit

Closes Image Menu.

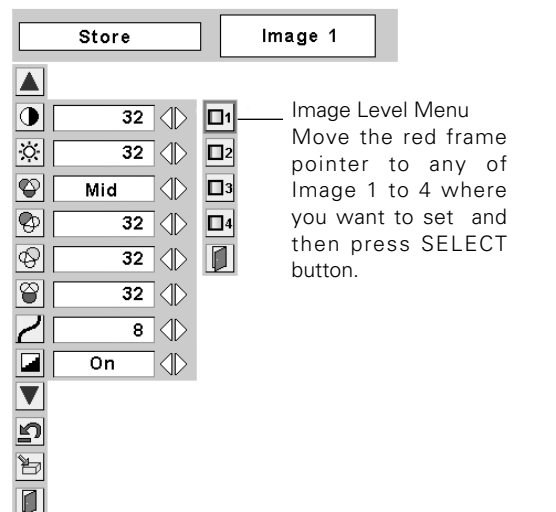
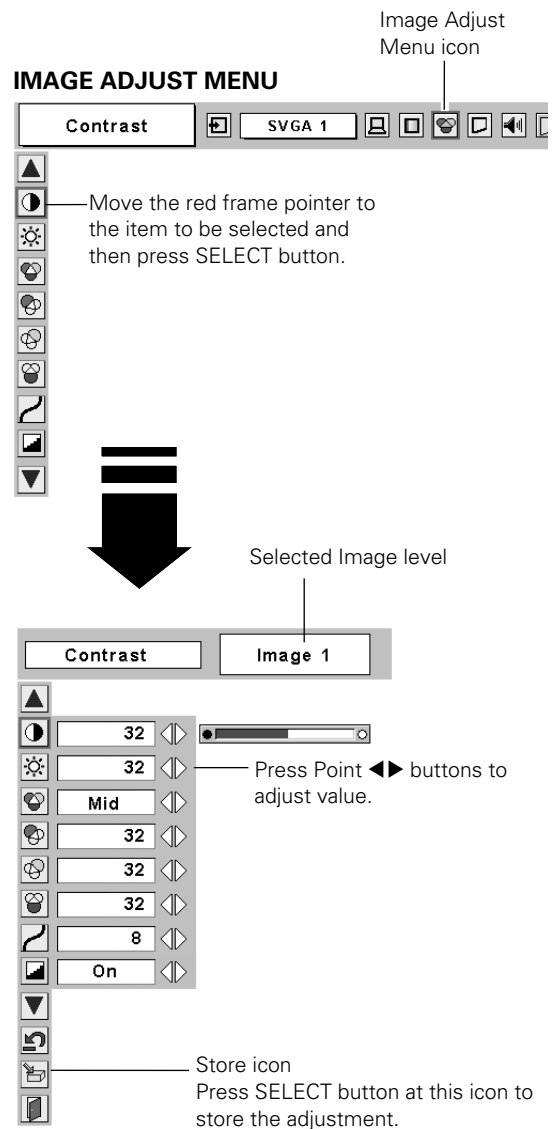

Screen Size Adjustment

This projector has a picture screen resize function, which enables you to display the desirable image size.

- 1 Press MENU button to display the On-Screen Menu. Press Point ◀▶ buttons to move the red frame pointer to Screen Menu icon.
- 2 Press Point ▼ button to move the red frame pointer to the function that you want to select. Then press SELECT button.

Normal

Provides an image to fit screen size.

True

Provides image in its original size. When the original image size is larger than screen size (800 x 600), this projector enters "Digital zoom +" mode automatically.

Wide

Provides image to fit wide video aspect ratio (16 : 9) by expanding image width uniformly. This function can be used for providing a squeezed video signal at 16 : 9.

Digital zoom +

When Digital zoom + is selected, the On-Screen Menu disappears and the message "D. Zoom +" is displayed. Press SELECT button to expand image size. And press Point ▲▼◀▶ buttons to pan the image. The panning function can work only when the image is larger than screen size.

A projected image can be also expanded by pressing D.ZOOM ▲ button on the remote control.

Digital zoom -

When Digital zoom - is selected, the On-Screen Menu disappears and the message "D. Zoom -" is displayed. Press SELECT button to compress image size.

A projected image can be also compressed by pressing D.ZOOM ▼ button on the remote control.

To cancel Digital Zoom +/- mode, press any button except D.ZOOM ▲▼, SELECT and Point buttons.

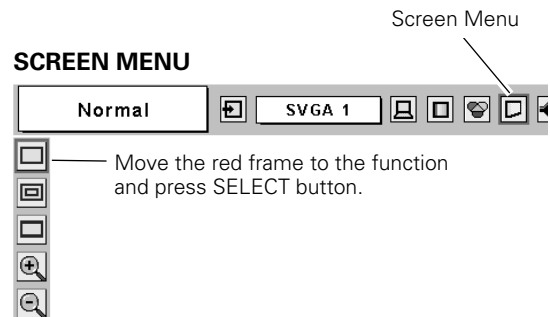

Note:

- This Screen Menu cannot be operated when "720p (HDTV)", "1035i (HDTV)" or "1080i (HDTV)" is selected on PC System Menu. (P23).
- True and Digital zoom +/- cannot be selected when "480i ", " 575i ", " 480p ", " 575p " is selected on PC System Menu (P23).
- This projector cannot display any resolution higher than 1280 X 1024. If your computer's screen resolution is higher than 1280 X 1024, reset the resolution to the lower before connecting projector.
- The image data in other than SVGA (800 x 600) is modified to fit the screen size in initial mode.
- The panning function may not operate properly if the computer system prepared on PC Adjust Menu is used.

Video Input

Input Source Selection (Video, S-Video)

Direct Operation

Choose Video by pressing INPUT button on the top control or VIDEO button on the remote control.

Before using these buttons, correct input source should be selected through menu operation as described below.

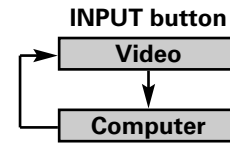

Menu Operation

- 1 Press MENU button to display the On-Screen Menu. Press Point ◀▶ buttons to move the red frame pointer to INPUT Menu icon.
- 2 Press Point ▼ button to move the red arrow pointer to Video and then press SELECT button. Source Select Menu will appear.
- 3 Move the pointer to the source that you want to select and then press SELECT button.

Auto When selecting Auto, the projector automatically detects incoming video signal, and adjusts itself to optimize its performance. The projector selects connection in the following order:

1st S-VIDEO

2nd VIDEO

The S-VIDEO has priority over the VIDEO

Video When video input signal is connected to VIDEO jack, select Video.

S-Video When video input signal is connected to S-VIDEO jack, select S-Video.

INPUT MENU

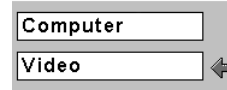

Move the red arrow pointer to Video and press SELECT button.

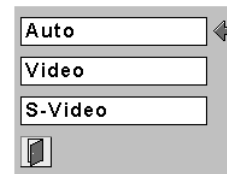

Source Select Menu (VIDEO)

Move the pointer to the source and press SELECT button.

Input Source Selection (Component, RGB Scart 21-pin)

Direct Operation

Choose Computer by pressing INPUT button on the top control or COMPUTER button on the remote control.

Before using these buttons, correct input source should be selected through menu operation as described below.

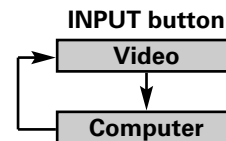

Menu Operation

- 1 Press MENU button to display the On-Screen Menu. Press Point ◀▶ button to move the red frame pointer to INPUT Menu icon.
- 2 Press Point ▼ button to move the red arrow pointer to Computer and then press SELECT button. The Source Select Menu will appear.
- 3 Move the pointer to the source that you want to select and then press SELECT button.

Component

When the input source is coming from video equipment connected to the COMPUTER IN /COMPONENT IN terminal with a Component-VGA Cable, select Component.

RGB (Scart)

When the input source is coming from video equipment connected to the COMPUTER IN /COMPONENT IN terminal with a Scart-VGA Cable, select RGB (Scart).

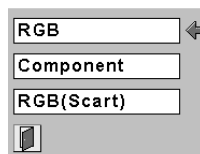
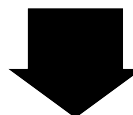
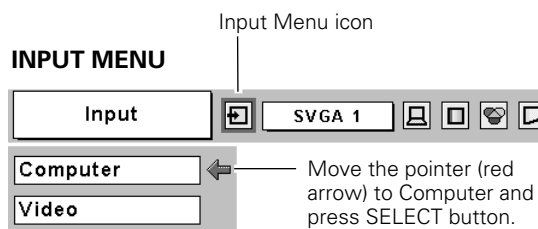

Source Select Menu

Move the pointer to Component or RGB (Scart) and press the SELECT button.

Note :

Component-VGA Cable and Scart-VGA Cable are optionally supplied. See page 51 for order.

Video System Selection

- 1 Press MENU button to display the On-Screen Menu. Press Point ◀▶ buttons to move the red frame pointer to AV System Menu icon.
- 2 Press Point ▼ button to move the red arrow pointer to the system that you want to select and then press SELECT button.

Video Jack or S-Video Jack

Auto

The projector automatically detects incoming video system, and adjusts itself to optimize its performance.

When Video System is PAL-M or PAL-N, select system manually.

PAL / SECAM / NTSC / NTSC4.43 / PAL-M / PAL-N

If projector cannot reproduce proper video image, it is necessary to select a specific broadcast signal format among PAL, SECAM, NTSC, NTSC 4.43, PAL-M, and PAL-N.

AV SYSTEM MENU (VIDEO OR S-VIDEO)

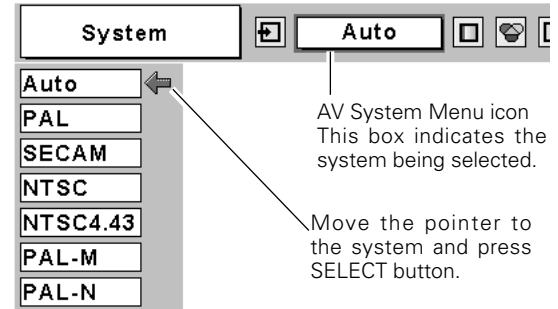

COMPUTER IN / COMPONENT IN Jack (Y, Pb/Cb, Pr/Cr)

Auto

The projector automatically detects incoming Video signal, and adjusts itself to optimize its performance.

COMPONENT VIDEO SIGNAL FORMAT

If the projector cannot reproduce proper video image, it is necessary to select a specific component video signal format among 480i, 575i, 480p, 575p, 720p, 1035i and 1080i.

AV SYSTEM MENU (COMPONENT VIDEO)

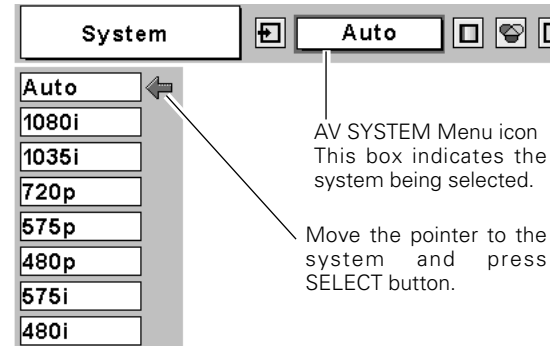

Image Level Selection

Direct Operation

Select image level among Standard, Cinema, Image 1, Image 2, Image 3 and Image 4 by pressing IMAGE button on the remote control.

Standard

Normal picture adjustment preset on this projector.

Cinema

Picture level adjusted for the picture with fine tone.

Image 1~4

User preset picture adjustment in Image Adjust Menu (P34-35).

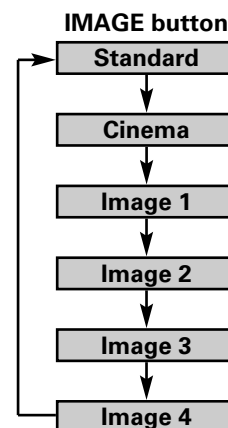

Menu Operation

1 Press MENU button to display the On-Screen Menu. Press Point ◀▶ button to move the red frame pointer to Image Select Menu icon.

2 Press Point ▼ button to move the red frame pointer to the level that you want to set and then press SELECT button.



Standard

Normal picture adjustment preset on this projector.



Cinema

Picture level adjusted for the picture with fine tone.



Image 1~4

User preset picture adjustment in Image Adjust Menu (P34-35).

IMAGE SELECT MENU

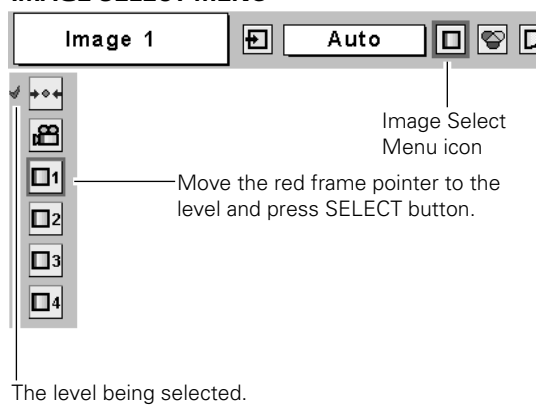

Image Level Adjustment

- 1 Press MENU button to display the On-Screen Menu. Press Point ◀▶ buttons to move the red frame pointer to IMAGE ADJUST Menu icon.
- 2 Press Point ▼ button to move the red frame pointer to the item that you want to adjust and then press SELECT button. The level of each item is displayed. Adjust each level by pressing Point ◀▶ buttons.



Contrast

Press Point ◀▶ buttons to adjust the image contrast. (From 0 to 63.)



Brightness

Press Point ◀▶ buttons to adjust the image brightness. (From 0 to 63.)



Color

Press Point ◀▶ buttons to adjust color intensity. (From 0 to 63.)



Tint

Press Point ◀▶ buttons to obtain proper color. (From 0 to 63.)



Color temp.

Press Point ◀▶ buttons to select the Color temp. level that you want to select. (XLow, Low, Mid, or High)



White balance (Red)

Press Point ◀▶ buttons to adjust the red tone. (From 0 to 63.)



White balance (Green)

Press Point ◀▶ buttons to adjust the green tone. (From 0 to 63.)



White balance (Blue)

Press Point ◀▶ buttons to adjust the blue tone. (From 0 to 63.)



Sharpness

Press Point ◀▶ buttons to adjust the image sharpness. (From 0 to 15.)



Gamma

Press Point ◀▶ buttons to obtain better balance of contrast. (From 0 to 15.)

IMAGE ADJUST MENU

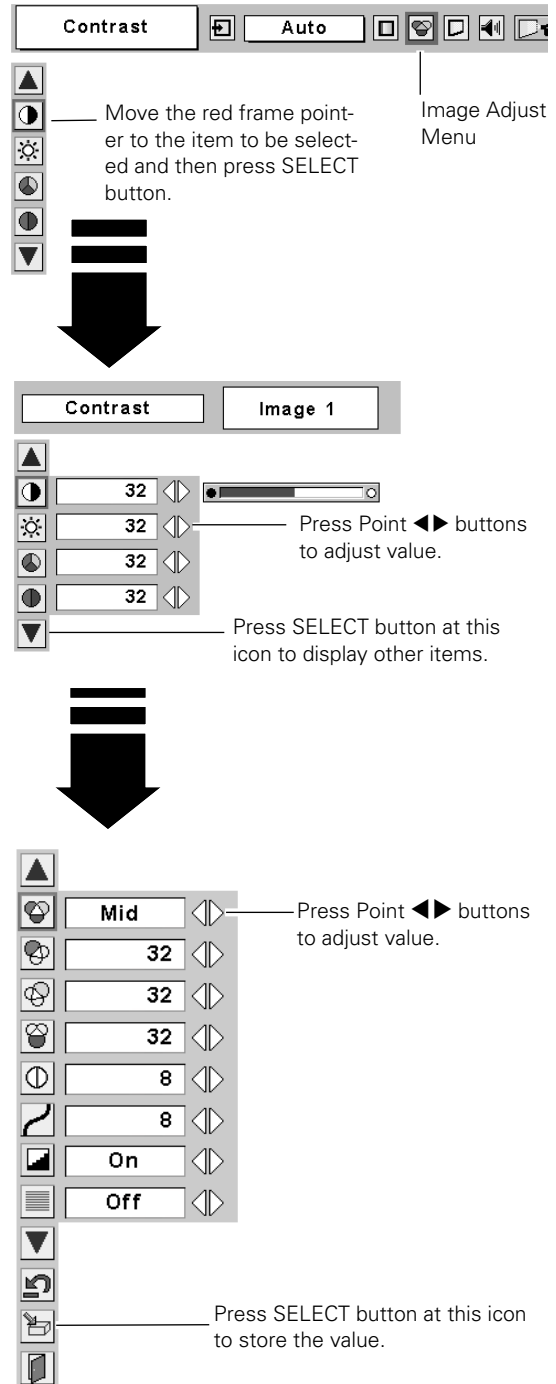

NOTE : Tint cannot be adjusted when the video system is PAL, SECAM, PAL-M or PAL-N.

Auto grayscale

When this function is "ON", it automatically enhances contrast of bright and dark part of image.

progressive

Interlace video signal can be displayed in a progressive picture.

Off Not activated.

L1 Select "L1" for an active picture.

L2 Select "L2" for a still picture.

Note : *The Progressive cannot be selected when 1080i, 1035i, 480p, 575p, or 720p is selected.*

Reset

Reset all adjustment to previous figure.

Store

To store the adjustment data, move the red frame pointer to Store icon and press SELECT button. Image Level Menu will appear. Move the red frame pointer to the Image Level 1 to 4 and then press SELECT button.

Quit

Closes the Image Menu.

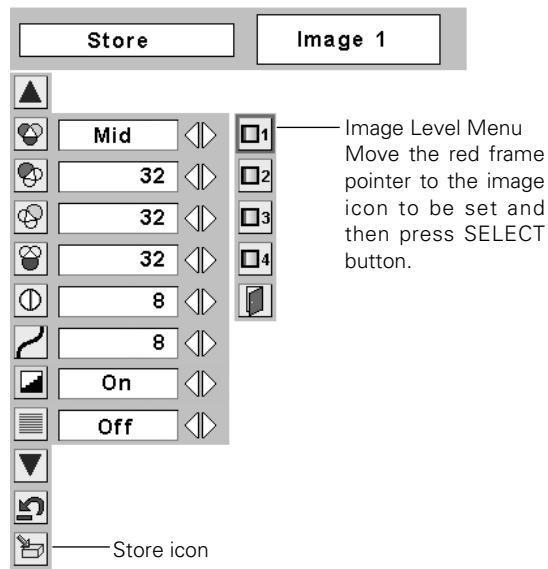

Screen Size Adjustment

This projector has a picture screen resize function, which enables you to display the desirable image size.

1 Press MENU button to display the On-Screen Menu. Press Point ◀▶ buttons to move the red frame pointer to Screen Menu icon.

2 Press Point ▼ button and move the red frame pointer to the function that you want to select and then press SELECT button.

Normal

Provides image at a normal video aspect ratio of 4 : 3.

Wide

Provides image at a wide screen ratio of 16 : 9.

SCREEN MENU



Note: *The Screen Menu cannot be operated when "720p," "1035i," or "1080i" is selected on the AV System Menu (P32).*

Setting Menu

- 1 Press MENU button to display the On-Screen Menu. Press Point ◀▶ buttons to move the red-frame pointer to SETTING icon.
- 2 Press Point ▼ button to move the red-frame pointer to the item that you want to set and then press SELECT button. Setting dialog box appears.

Language

Language used in the On-Screen Menu is selectable from among English, German, French, Italian, Spanish, Portuguese, Dutch, Swedish, Russian, Chinese, Korean and Japanese.

Keystone

This function corrects the distorted image. Select either of Store or Reset and press SELECT button. The keystone dialog box will appear. (P20)

- Store Store the keystone adjustment data even if the AC power cord is disconnected.
- Reset Reset the keystone adjustment data when the AC power cord is disconnected from the AC outlet.

Blue back

When this function is "On," the projector will project a blue image on the screen if any input signal is not detected.

Display

This function decides whether to display On-Screen Displays.

- Onshows all the On-Screen Displays.
- Offsets On-Screen Displays disappeared except;
- On-Screen Menu
 - "Power off?" message (P19)
 - P-TIMER (P21)
 - "No signal" message (P37)
 - "Wait a moment!" message

Logo

This function decides what to be displayed on the starting display.

- User . . . the image you captured
- Default . . . the factory set logo
- Off . . . count-down only

Capture

This function is used to capture the image being projected and use it for a starting-up display. After capturing the projected image, go to the Logo function (above) and set it as "User". Then the captured image will be displayed when turning on the projector next time.

To capture the image, select [Yes]. To cancel the Capture function, select [No].

Before capturing an image, select Standard in the Image Select Menu to capture a proper image. (P27, P33)

A signal from a computer can be captured up to XGA(1024 x 768). A signal from video equipment can be captured except for 720p, 1035i, and 1080i. When capturing the image that has been adjusted by the Keystone function, the adjustment data is automatically reset and the projector captures an image without keystone adjustment.

SETTING MENU

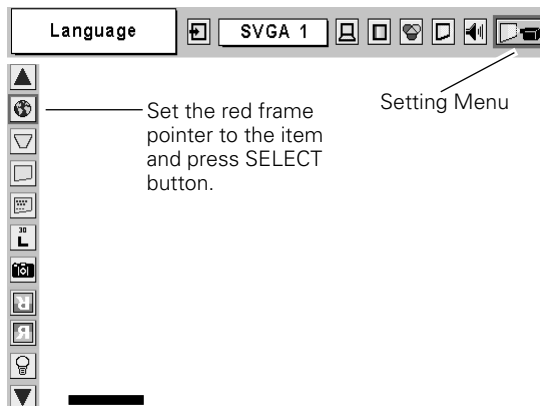

Set the red frame pointer to the item and press SELECT button.

Setting Menu

Press SELECT button at Language to show the Language Menu.

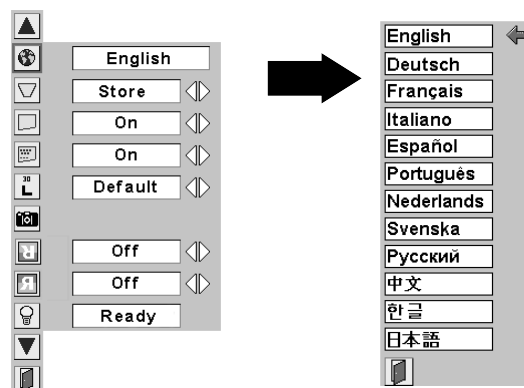

Capture

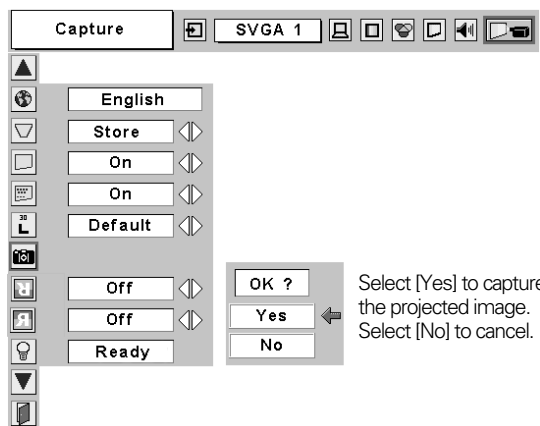

Select [Yes] to capture the projected image. Select [No] to cancel.

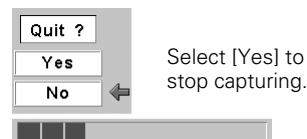

Select [Yes] to stop capturing.

Ceiling

When this function is "On," picture is top / bottom and left / right reversed. This function is used to project the image from a ceiling mounted projector.

Rear

When this function is "On," picture is left / right reversed. This function is used to project the image to a rear projection screen.

Power management

For reducing power consumption as well as maintaining the lamp life, the Power Management function turns off the projection lamp when the input signal is interrupted and no button is pressed for 30 seconds or more.

If the input signal is interrupted and no button is pressed for 30 seconds or more, the timer display with the message " No signal " appears on the screen. The count-down of the set time will get started. The count-down time can be set between 1 and 30 minutes.

When the count-down time has been elapsed, the lamp will be turned off to cool itself down. The POWER indicator is flashing red during this cooling-off period. The next operation depends on the setting as follows :



Ready When the lamp has been fully cooled down, the POWER indicator changes to green flashing. In this condition, the projection lamp will be turned on if the input signal is reconnected or any button on the top control or remote control is pressed.

Shutdown When the lamp has been fully cooled down, the power will be turned off.

Off The Power Management function is canceled.

Lamp mode

This function allows you to change brightness of the screen.

-  . . . normal brightness
-  . . . the controlled brightness according with input signal
-  . . . lowers brightness, reduces the lamp power consumption, and extends the lamp life.

Ceiling function

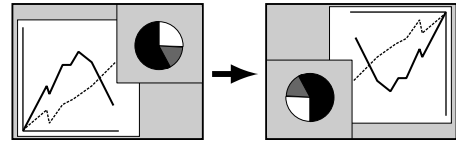

Rear function

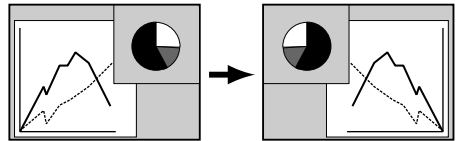

Power management

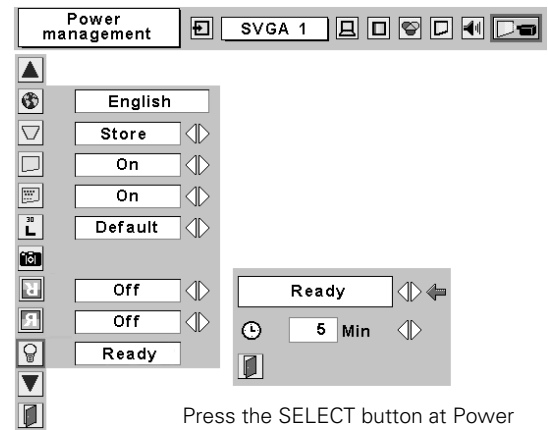

Press the SELECT button at Power management to show this box. Choose one of three settings with the Point ◀▶ button, and navigate to the timer with the Point ▲▼ button and set time with the Point ◀▶ button.



Time left until Lamp off

Lamp mode

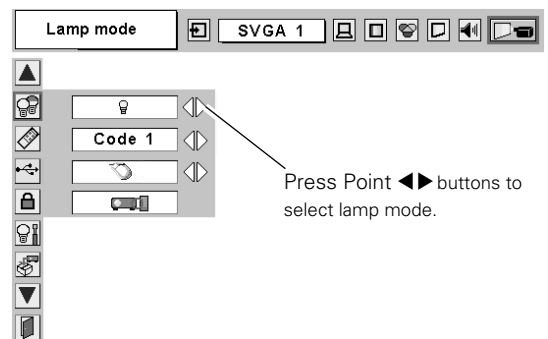

Remote control

This projector has two different remote control codes; the factory-set normal code (Code 1) and the secondary code (Code 2). This switching function prevents remote control interference when operating several projectors or video equipment at the same time. When operating the projector in "Code 2," both the projector and remote control must be switched to "Code 2."

To change the code of the projector :

Set the remote control in the SETTING MENU to "Code 2."

To change the code of the remote control :

Press and hold both MENU and IMAGE buttons on the remote control together for 10 seconds or more. After changing the code, make sure the remote control operates properly.

To return to the normal code (Code 1), operate both the projector and remote control in the ways above again.

Note : When battery of the remote control is replaced, the remote control code automatically returns to the normal code (Code 1).

Remote Control

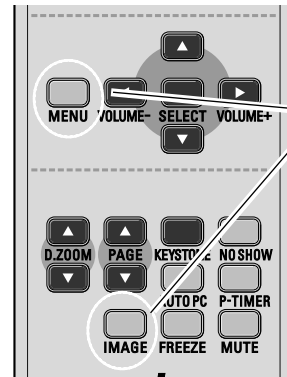

Press and hold MENU and IMAGE buttons for 10 seconds or more.

USB

This projector is equipped with the USB port for interactive operation between the projector and computer. Selects either of the followings as needed.

 When using the PAGE ▲▼ buttons on the remote control. (P10)

 When controlling the projector with a computer. This item is provided for future use. Not available now.

Key lock

This function locks operation of the top control and remote control. It is useful to prevent operation by a third person.

 Not locked.

 Locks operation of the top control. To unlock, use the remote control.

 Locks operation of the remote control. To unlock, use the top control.

If the top control accidentally becomes locked and you do not have the remote control nearby, disconnect the AC power cord to turn off the power, and then while pressing the SELECT button, reinsert the AC power cord. This will unlock the top control operation.

Lamp counter reset

This function is used to reset the lamp replace counter. When replacing the projection lamp, reset the lamp replace counter by using this function. Refer to page 41 for operation.

Factory default

This function returns all setting values except for the lamp counter to the factory default settings.

Key lock

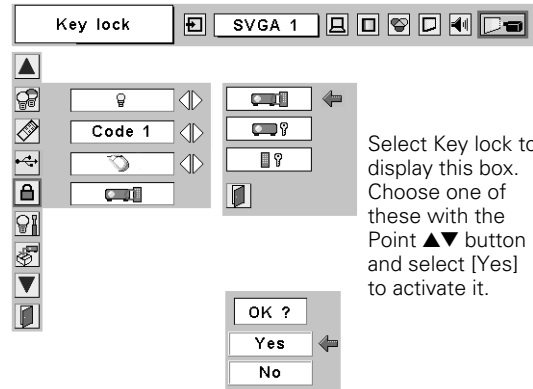

Select Key lock to display this box. Choose one of these with the Point ▲▼ button and select [Yes] to activate it.

Factory default

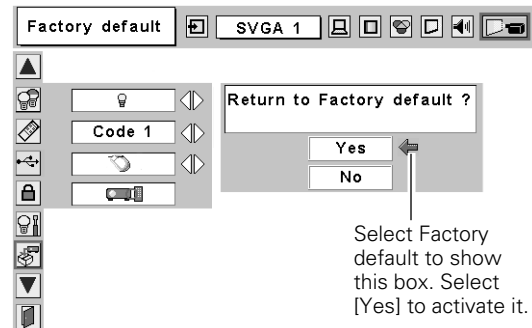

Select Factory default to show this box. Select [Yes] to activate it.

Using the Presentation Remote Control

Presentation Remote Control

Presentation Remote Control performs the function of a wireless mouse to control the mouse cursor on the computer. For convenience while giving presentations, some buttons controlling the projector are also provided.

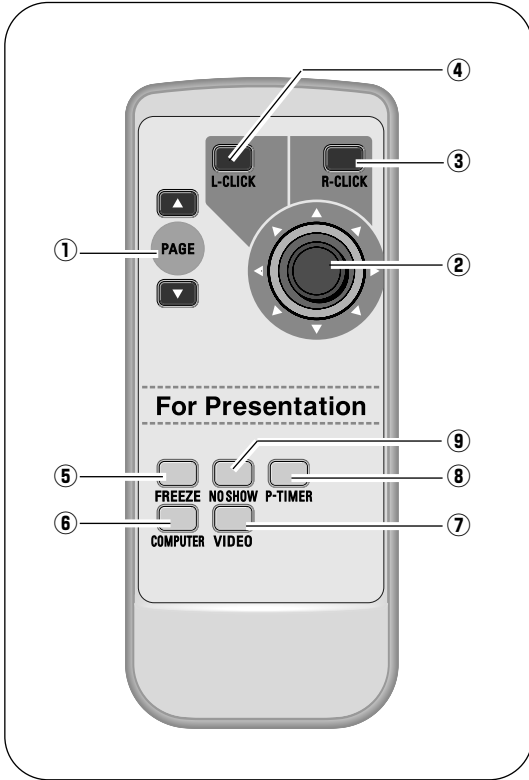

For computer

Aim the remote control at the Presentation Remote receiver.

- 1 PAGE ▲▼ buttons**
Scroll back and forth pages on the screen when giving presentations.
- 2 Cursor button**
Scroll back and forth pages on the screen when giving a presentation.
- 3 R-CLICK button**
Acts as the right button on a computer mouse.
- 4 L-CLICK button**
Acts as the left button on a computer mouse.
To drag a selected item, press and hold the L-CLICK button and move the cursor with the Cursor button.

For projector

Aim the remote control at the IR receiver of the projector.

- 5 FREEZE button**
Freezes the picture. (P20)
- 6 COMPUTER button**
Selects COMPUTER input source. (P22)
- 7 VIDEO button**
Selects VIDEO input source. (P30)
- 8 P-TIMER button**
Operates the P-timer function. (P21)
- 9 NO SHOW button**
Temporarily turns off the image on the screen. (P21)

Installation

- 1 Connect the Projector and your computer with the VGA cable.
- 2 Connect the Presentation Remote Receiver to the USB port of your computer.

Note :

- The Presentation Remote Receiver can only be connected with a standard USB port..
- Some computer settings may have to be changed in order for the mouse function to be used. Refer to your computer's owner's manual for details.
- When switching the remote control code of the projector and the remote control, that of the presentation remote control also needs to be switched. Press and hold both the FREEZE and P-TIMER buttons together for 10 seconds or more to switch the code. (P38)

Compatible computers

Windows

- Windows 98 / 2000/ Me / XP
 - * Compatible with only full versions of Windows. (Upgraded version cannot be used.)

Macintosh

- Mac OS 9.1 or later.

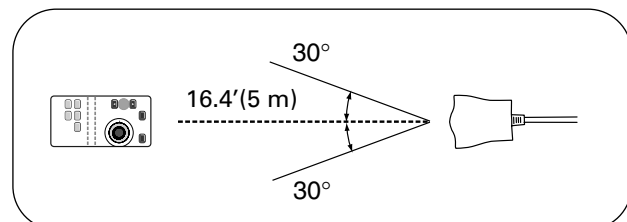
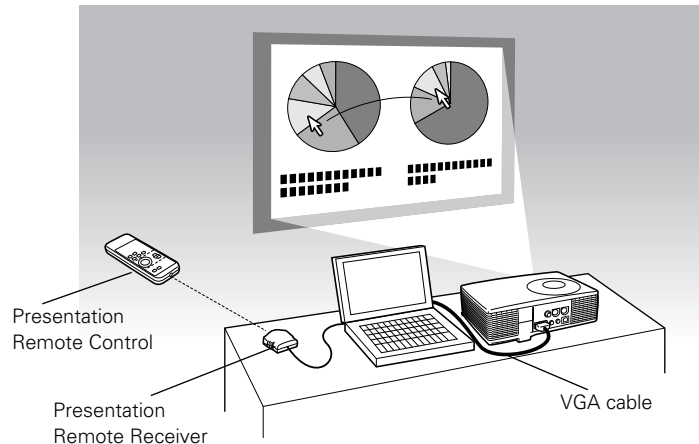

Maintenance

Lamp Replacement

Lamp Replace

When the life of the projection lamp draws to an end, LAMP REPLACE indicator lights yellow. If this indicator lights yellow, replace the projection lamp with a new one promptly.

This indicator lights yellow when the life of the projection lamp draws to an end.

TOP CONTROL

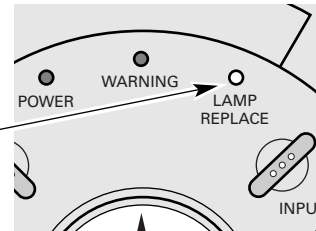

Allow a projector to cool, for at least 45 minutes before you open Lamp Cover. The inside of a projector can become very hot.



CAUTION

For continued safety, replace with a lamp assembly of the same type. Do not drop a lamp assembly or touch a glass bulb! The glass can shatter and may cause injury.

Follow these steps to replace the lamp assembly.

- 1** Turn off the projector and disconnect AC plug. Allow the projector to cool at least for 45 minutes.
- 2** To remove the lamp cover, remove the screw with a screwdriver .
- 3** Remove the two screws with a screwdriver and pull out the lamp assembly by grasping the handle.
- 4** Replace the lamp assembly with a new one and tighten the two screws back into the position. Make sure that the lamp assembly is set properly. Replace the lamp cover and tighten the screw.
- 5** Connect the AC Power Cord to the projector and turn on the projector.
- 6** **Reset the Lamp Replace Counter.** Refer to "Lamp Replace Counter" on the next page .

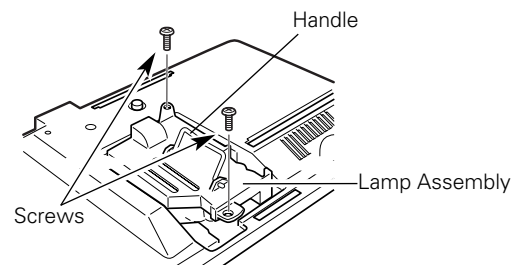
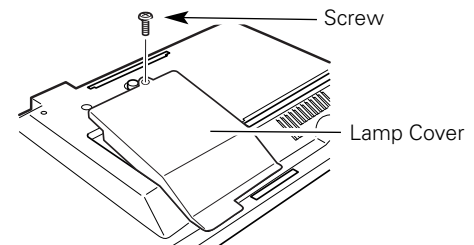

Note :

Do not reset the Lamp Replace Counter when the projection lamp has not been replaced.

ORDER REPLACEMENT LAMP

Replacement Lamp can be ordered through Boxlight at 1-800-762-5757 or 360-779-7901. When ordering a Projection Lamp, give the following information to the dealer.

- **Model No. of your projector** : **BOXLIGHT SP-10t**
- **Replacement Lamp Type No.** : **POA-LMP57**

(Service Parts No. 610 308 3117)

Lamp Replace Counter

Be sure to reset the lamp replace counter after Lamp Assembly is replaced. When the lamp replace counter is reset, the LAMP REPLACE Indicator stops lighting.

- 1 Turn projector on, press MENU button to display the On-Screen Menu. Press Point ◀▶ button(s) to move the red frame pointer to the Setting Menu icon.
- 2 Press Point ▼ button to move the red frame pointer to "Lamp counter reset" and then press SELECT button. The message "Lamp replace counter reset?" is displayed. Move the pointer to [Yes] and then press SELECT button.
- 3 Another confirmation dialog box appears and select [Yes] to reset the lamp replace counter.

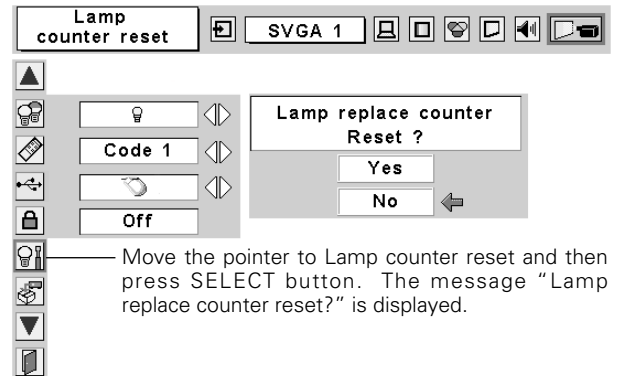

Note : Do not reset the Lamp Replace Counter until after the projection lamp is replaced.



LAMP HANDLING PRECAUTIONS

This projector uses a high-pressure lamp which must be handled carefully and properly. Improper handling may result in accidents, injury, or create a fire hazard.

- Lamp lifetime may differ from lamp to lamp and according to the environment of use. There is no guarantee of the same lifetime for each lamp. Some lamps may fail or terminate their lifetime in a shorter period of time than other similar lamps.
- If the projector indicates that the lamp should be replaced, i.e., if the LAMP REPLACE INDICATOR lights up, replace the lamp with a new one IMMEDIATELY after the projector has cooled down.
(Follow carefully the instructions in the LAMP REPLACEMENT section of this manual.) Continuous use of the lamp with the LAMP REPLACE INDICATOR lighted may increase the risk of lamp explosion.
- A Lamp may explode as a result of vibration, shock or degradation as a result of hours of use as its lifetime draws to an end. Risk of explosion may differ according to the environment or conditions in which the projector and lamp are being used.

IF A LAMP EXPLODES, THE FOLLOWING SAFETY PRECAUTIONS SHOULD BE TAKEN.

If a lamp explodes, disconnect the projector's AC plug from the AC outlet immediately. Contact an authorized service station for a checkup of the unit and replacement of the lamp. Additionally, check carefully to ensure that there are no broken shards or pieces of glass around the projector or coming out from the cooling air circulation holes. Any broken shards found should be cleaned up carefully. No one should check the inside of the projector except those who are authorized trained technicians and who are familiar with projector service. Inappropriate attempts to service the unit by anyone, especially those who are not appropriately trained to do so, may result in an accident or injury caused by pieces of broken glass.

Warning Indicator

The WARNING indicator shows the state of the function which protects the projector. Check the state of the WARNING indicator and the POWER indicator to take proper maintenance.

The projector is shut down and the WARNING indicator is flashing red

When the temperature inside the projector exceeds the normal temperature, the projector is automatically shut down to protect the inside of the projector. The POWER indicator is flashing and the projector is being cooled down. When the temperature inside the projector returns to normal, the POWER indicator lights red and the projector can be turned on.

Note :

After the temperature inside the projector returns to normal, the WARNING indicator still continues to flash. When the projector is turned on again, the WARNING indicator stops flashing.

Then check the items below.

- ✓ Did you provide appropriate space for the projector to be ventilated? Check the installing condition to see if ventilation slots are not blocked.
- ✓ Is the projector not installed near the ventilation duct of air-conditioning equipment which may be hot? Install the projector away from the ventilation duct of air-conditioning equipment.
- ✓ Are the air filters clean? Clean the air filters periodically.

The projector is shut down and the WARNING indicator lights red

When the projector detects an abnormal condition, it is automatically shut down to protect the inside and the WARNING indicator lights red. In this case, disconnect the AC power cord and reconnect it, and then turn the projector on once again for check. If the projector is still turned off and the WARNING indicator lights red, disconnect the AC power cord and call Boxlight at 1-800-762-5757 or 360-779-7901 for service.



CAUTION

DO NOT LEAVE THE PROJECTOR WITH THE AC POWER CORD CONNECTED UNDER THE ABNORMAL CONDITION. IT MAY RESULT IN FIRE OR ELECTRIC SHOCK.

Top Control

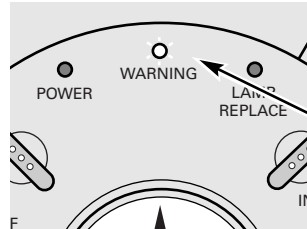

WARNING flashing red

Top Control

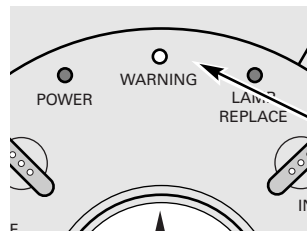

WARNING lights red

Air Filter

Removable air filters prevent dust from accumulating on the surface of optical elements inside the projector. Should air filters become clogged with dust particles, it will reduce the cooling fans' effectiveness and may result in internal heat build up and adversely affect the life of the projector. Clean air filters following the steps below:

- 1** Turn off the projector, and disconnect AC power cord from the AC outlet.
- 2** Turn the projector upside down and remove air filters by pulling the latches upward.
- 3** Clean the air filters with a brush or wash out dust and particles.
- 4** Replace each air filter properly. Make sure that the air filters are fully inserted.



CAUTION

Do not operate the projector with the air filters removed. Dust may accumulate on optical elements inside the projector degrading picture quality. Do not put small parts into Air Intake Vents. It may result in malfunction of the projector.

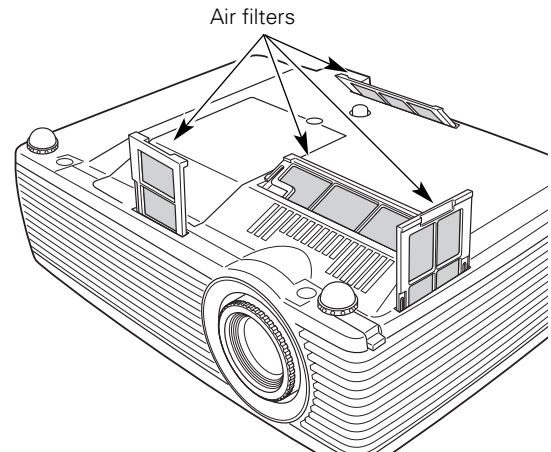

RECOMMENDATION

We recommend avoiding dusty/smoky environments when operating a projector. Usage in these environments may cause poor image quality.

When using under dusty or smoky conditions, dust may accumulate on or optical elements inside the projector. This condition may degrade the quality of a projected image.

When the above symptoms are noticed, contact Boxlight at 1-800-762-5757 or 360-779-7901 for proper cleaning.

Cleaning the Projection Lens

Follow these steps to clean the projection lens:

- 1** Apply a non-abrasive camera lens cleaner to a soft, dry cleaning cloth. Avoid using an excessive amount of cleaner. Abrasive cleaners, solvents or other harsh chemicals might scratch a surface.
- 2** Lightly wipe Projection Lens with a cleaning cloth.
- 3** When the projector is not in use, replace the Lens Cover.

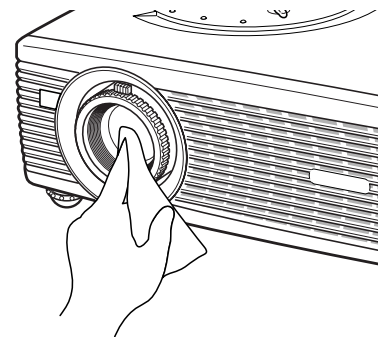

Appendix

Troubleshooting

Before calling your dealer or service center for assistance, check the matters below once again.

- Make sure you have properly connected the projector to peripheral equipment as described in the section "Installation" on P15-16.
- Make sure all equipment is connected to AC outlet and turned on the power.
- When you operate the projector with a computer, and it does not project an image, restart the computer.

Problem:	- Try these Solutions
No power.	<ul style="list-style-type: none">- Plug the projector into your AC outlet.- Make sure if the POWER Indicator lights red.- Wait 90 seconds after a projector is turned OFF when turning the projector back on. The projector can be turned on after the Power indicator turns red. (☞ "Turning Off the Projector " P19)- Check WARNING TEMP. indicator. If the indicator flashes red, the projector cannot be turned on. (☞ "Warning Indicator " P42)- Check the projection lamp. (☞ P40-41)- Unlock Key lock for the projector in the Setting Menu. (☞ P38)
Image is out of focus.	<ul style="list-style-type: none">- Adjust focus of the projector. (☞ P20)- Provide proper distance between the projector and projection screen. (☞ P13)- Check the projection lens to see if it needs cleaning. (☞ P43)- Moving the projector from a cool temperature location to a warm temperature location may result in moisture condensation on the projection lens. In such an event, leave the projector OFF and wait until condensation disappears.
Picture is Left/Right reversed.	<ul style="list-style-type: none">- Check Ceiling / Rear feature. (☞ "Setting" on page 37)
Picture is Top/Bottom reversed.	<ul style="list-style-type: none">- Check Ceiling feature. (☞ "Setting" on page 37)
Some displays are not seen during the Operation.	<ul style="list-style-type: none">- Check Display feature.(☞ "Setting" on page 36)
No image.	<ul style="list-style-type: none">- Check the connection between your computer or video equipment and the projector.- Check if the input signal is correctly output from your computer. Some laptop computers may need to change the setting for monitor output when connected to the projector. See the computer's owner's manual for its setting.- Check NO SHOW function. (☞ P21)- When turning on the projector, it takes about 30 seconds to display an image.- Check the system that you select is corresponding with your computer or video equipment.- Select correct input source once again following the menu operation.- Make sure the temperature is not out of the operating temperature range (5°C ~ 35°C).
No sound.	<ul style="list-style-type: none">- Check audio cable connection from audio input source. (☞ P15-16)- Adjust the audio source.- Press VOLUME (+) button.(☞ P21)- Press MUTE button. (☞ P21)

Problem:	– Try these Solution
Remote Control does not work.	<ul style="list-style-type: none"> – Check the battery. – Make sure nothing is between the infrared remote receiver and remote control. – Make sure you are not too far from the projector when using the remote control. Maximum operating range is 16.4' (5m). – Make sure the code of the remote control is set to conform to the projector. (P38) – Unlock Key lock for the remote control in the Setting Menu. (P38)
Presentation kit does not work	<ul style="list-style-type: none"> – Check the presentation remote receiver is properly connected to your computer. (P39) – Check the mouse setting on your computer.

WARNING :

High voltages are used to operate this projector. Do not attempt to open the cabinet.

If the problem still persists after following all operating instructions, contact Boxlight for assistance at 1-800-762-5757 or 360-779-7901. Give the model number and explain about the problem. We will advise you how to obtain service.

Please have the following information available.

























- Serial No. of projector.
- Resolution of the computer.
- Refresh rate of computer.



This symbol on the nameplate means the product is Listed by Underwriters Laboratories Inc. It is designed and manufactured to meet rigid U.L. safety standards against risk of fire, casualty and electrical hazards.

Indicators and Projector Condition

Check the indicators for projector condition.

Indicators			Projector Condition
POWER red/green	WARNING red	LAMP REPLACE yellow	
			The projector is OFF. (The AC power cord is unplugged.)
			The projector is preparing for stand-by or the projection lamp is being cooled down. The projector cannot be turned on until cooling is completed.
			The projector is ready to be turned on with the POWER ON-OFF button.
			The projector is operating normally.
			The projector is in the Power management mode.
			The temperature inside the projector is abnormally high. The projector cannot be turned on. When the projector is cooled down enough and the temperature returns to normal, the POWER indicator lights red and the projector can be turned on. (The WARNING indicator keeps flashing.) Check and clean the Air filter.
			The projector has been cooled down enough and the temperature returns to normal. When turning on the projector, the WARNING indicator stops flashing. Check and clean the air filters.
			The projector detects an abnormal condition and cannot be turned on. Unplug the AC power cord and plug it again to turn on the projector. If the projector is turned off again, disconnect the AC power cord and contact the dealer or the service center for service and checkup. Do not leave the projector on. It may cause electric shock or a fire hazard.

 lights green.
  flashes green.
  lights red.
  flashes red.
  off

* When the life of the projection lamp draws to an end, the LAMP REPLACE indicator lights yellow. When this indicator lights yellow, replace the projection lamp with a new one promptly. Reset the Lamp replace counter after replacement of the lamp. (P40-41)

Menu Tree

Main menu

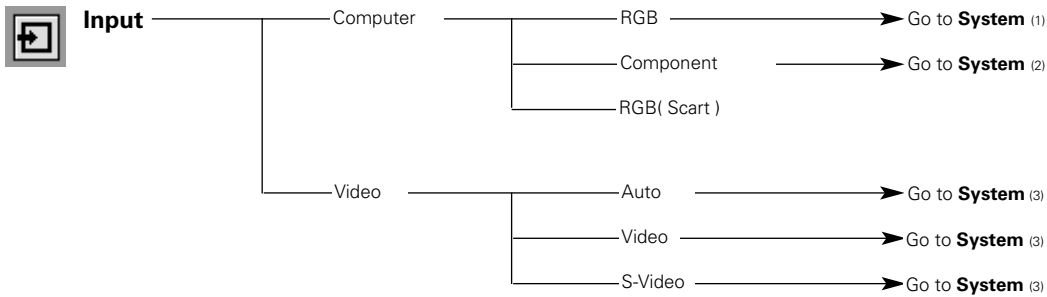

Computer Input

Main menu

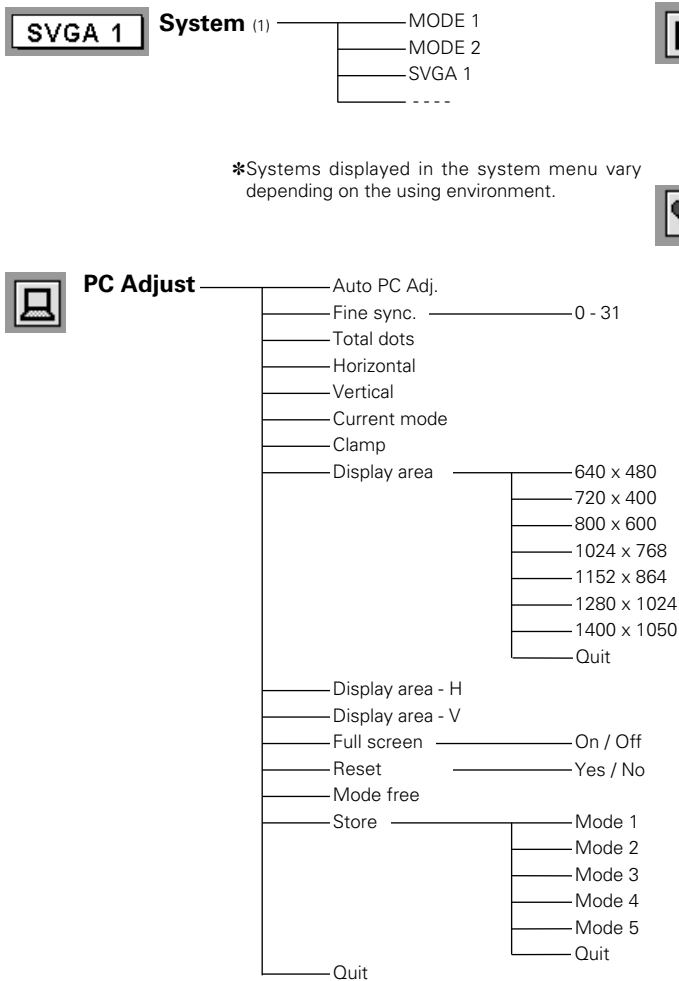

*Systems displayed in the system menu vary depending on the using environment.

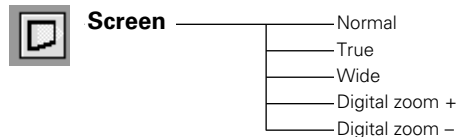
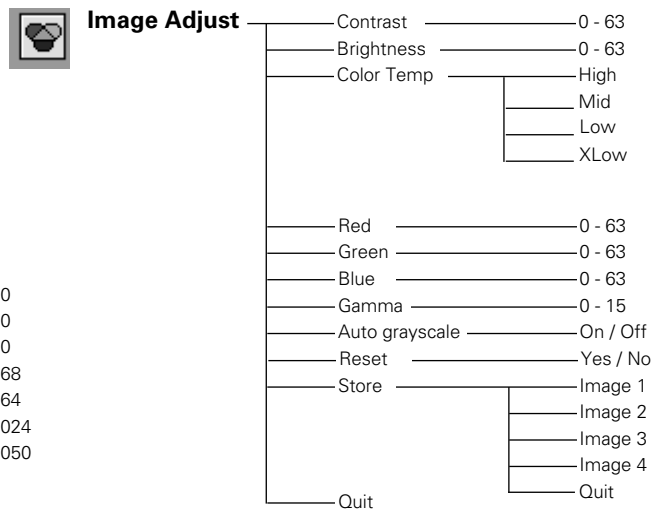
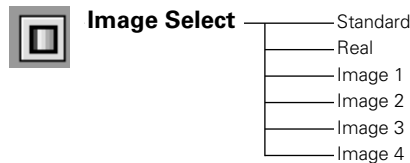

Video Input

Main menu

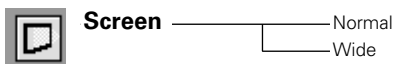
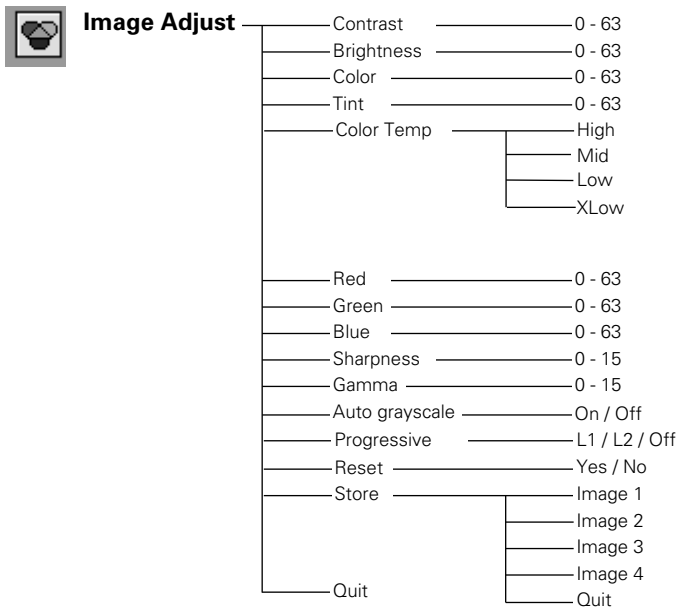
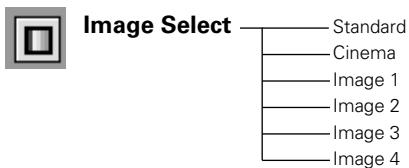
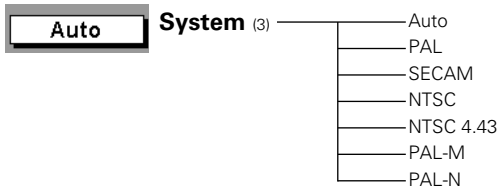
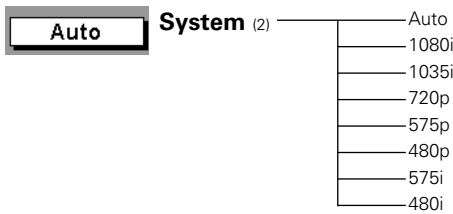

Settings

Main menu

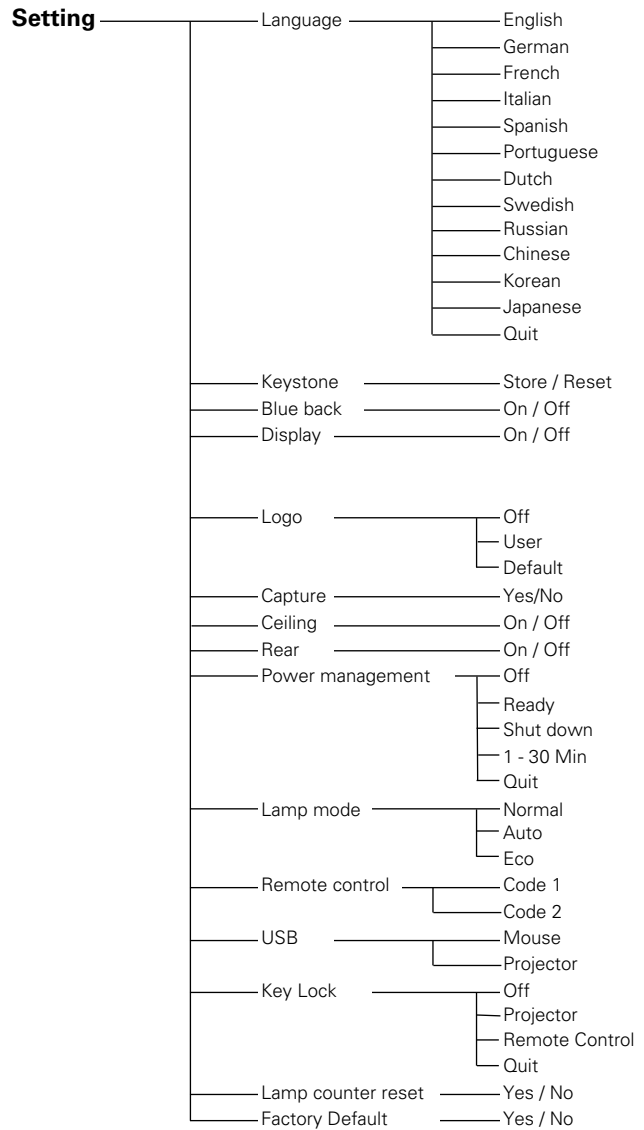
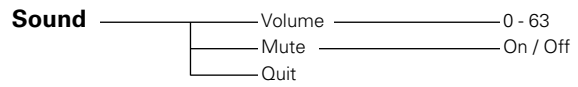

Compatible Computer Specifications

Basically this projector can accept the signal from all computers with the V, H-Frequency below mentioned and less than 100 MHz of Dot Clock.

ON-SCREEN DISPLAY	RESOLUTION	H-Freq. (kHz)	V-Freq. (Hz)	ON-SCREEN DISPLAY	RESOLUTION	H-Freq. (kHz)	V-Freq. (Hz)
VGA 1	640 x 480	31.47	59.88	XGA 2	1024 x 768	68.677	84.997
VGA 2	720 x 400	31.47	70.09	XGA 3	1024 x 768	60.023	75.03
VGA 3	640 x 400	31.47	70.09	XGA 4	1024 x 768	56.476	70.07
VGA 4	640 x 480	37.86	74.38	XGA 5	1024 x 768	60.31	74.92
VGA 5	640 x 480	37.86	72.81	XGA 6	1024 x 768	48.50	60.02
VGA 6	640 x 480	37.50	75.00	XGA 7	1024 x 768	44.00	54.58
VGA 7	640 x 480	43.269	85.00	XGA 8	1024 x 768	63.48	79.35
MAC LC13	640 x 480	34.97	66.60	XGA 9	1024 x 768	36.00	87.17 (Interlace)
MAC 13	640 x 480	35.00	66.67	XGA 10	1024 x 768	62.04	77.07
480p	————	31.47	59.88	XGA 11	1024 x 768	61.00	75.70
575p	————	31.25	50.00	XGA 12	1024 x 768	35.522	86.96 (Interlace)
480i	————	15.734	60 (Interlace)	XGA 13	1024 x 768	46.90	58.20
575i	————	15.625	50 (Interlace)	XGA 14	1024 x 768	47.00	58.30
SVGA 1	800 x 600	35.156	56.25	XGA 15	1024 x 768	58.03	72.00
SVGA 2	800 x 600	37.88	60.32	MAC 19	1024 x 768	60.24	75.08
SVGA 3	800 x 600	46.875	75.00	MAC 21	1152 x 870	68.68	75.06
SVGA 4	800 x 600	53.674	85.06	SXGA 1	1152 x 864	64.20	70.40
SVGA 5	800 x 600	48.08	72.19	SXGA 11	1152 x 900	61.20	65.20
SVGA 6	800 x 600	37.90	61.03	SXGA 13	1280 x 1024	50.00	86.00 (Interlace)
SVGA 7	800 x 600	34.50	55.38	SXGA 14	1280 x 1024	50.00	94.00 (Interlace)
SVGA 8	800 x 600	38.00	60.51	SXGA 17	1152 x 900	61.85	66.00
SVGA 9	800 x 600	38.60	60.31	SXGA 18	1280 x 1024	46.43	86.70 (Interlace)
SVGA 10	800 x 600	32.70	51.09	720p (HDTV)	————	45.00	60.00
SVGA 11	800 x 600	38.00	60.51	1035i (HDTV)	————	33.75	60.00 (Interlace)
MAC 16	832 x 624	49.72	74.55	1080i (HDTV)	————	33.75	60.00 (Interlace)
XGA 1	1024 x 768	48.36	60.00	1080i (HDTV)	————	28.125	50.00 (Interlace)

NOTE : Specifications are subject to change without notice.

Technical Specifications

Projector Type	Multi-media Projector
Dimensions (W x H x D)	10.63" x 3.07" x 7.48" (270mm x 78.0mm x 190mm) (not including Adjustable Feet)
Net Weight	4.6lbs (2.1 kg)
LCD Panel System	0.5" TFT Active Matrix type, 3 panels
Panel Resolution	800 x 600 dots
Number of Pixels	1,440,000 (800 x 600 x 3 panels)
Color System	PAL, SECAM, NTSC, NTSC4.43, PAL-M and PAL-N
High Definition TV Signal	480i, 480p, 575i, 575p, 720p, 1035i, and 1080i
Scanning Frequency	H-sync. 15 ~ 80 KHz, V-sync. 50 ~ 100 Hz
Projection Image size (Diagonal)	Adjustable from 34" to 200"
Projection Lens	F 1.6 ~ 1.8 lens with f 18.3 mm ~ 21.9 mm with manual zoom and focus
Throw Distance	4.3' ~ 21.2' (1.3 m ~ 6.5 m)
Projection Lamp	160 W
Video Input Jack	RCA Type x 1 (Video) and Mini DIN 4 pin x 1 (S-Video)
Audio Input Jack	Mini Jack (stereo) x 1
Computer Input Terminal	(VGA) HDB 15 Terminal x 1
Computer Audio Input Jack	Mini Jack (stereo) x 1
Control Port Connector	Mini DIN 8 pin x 1
USB Connector	USB Series B receptacle x 1
Internal Audio Amp	0.8 W RMS
Built-in Speaker	1 speaker, ϕ 1.3" (32mm)
Feet Adjustment	0° to 8.0°
Voltage and Power Consumption	AC 100 ~ 120 V (2.4 A Max. Ampere), 50 / 60 Hz (The U.S.A and Canada) AC 200 ~ 240 V (1.2 A Max. Ampere), 50 / 60 Hz (Continental Europe)
Operating Temperature	41 °F – 95 °F (5 °C – 35 °C)
Storage Temperature	14 °F – 140 °F (-10 °C – 60 °C)
Remote Control	Power Source : AAA, SUM-04 or R03 type x 2 Operating Range : 16.4' (5m) / \pm 30° Dimensions : 2.0"(W) x 0.91"(H) x 4.8"(D) (51.5mm x 23.2mm x 123mm) Net Weight : 2.11oz (60 g) (including battery)
Accessories	Owner's Manual AC Power Cord Remote Control and Battery Presentation Remote Control and Battery Presentation Remote Receiver VGA Cable Carrying Bag Lens Cover String for Lens Cover

- The specifications are subject to change without notice.
- LCD panels are manufactured to the highest possible standards. Even though 99.99% of the pixels are effective, a tiny fraction of the pixels (0.01% or less) may be ineffective by the characteristics of the LCD panels.

Configuration of Terminals

COMPUTER INPUT TERMINAL (ANALOG)

Terminal : HDB15-PIN

Pin Configuration

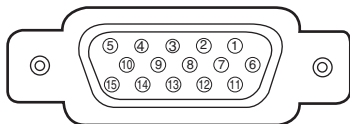

1	R / Cr, Pr Input	9	No Connect
2	G / Y Input	10	Ground (Vert.sync.)
3	B / Cb, Pb Input	11	Ground
4	No Connect	12	No Connect
5	Ground (Horiz.sync.)	13	Horiz. sync.
6	Ground (Red)	14	Vert. sync.
7	Ground (Green)	15	No Connect
8	Ground (Blue)		

CONTROL PORT CONNECTOR

Terminal : Mini DIN 8-PIN

Pin Configuration

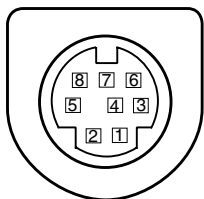

	PS/2	Serial	ADB
1	----	R X D	----
2	----	----	----
3	----	----	----
4	GND	GND	GND
5	----	----	----
6	----	T X D	----
7	----	----	----
8	----	----	----

USB CONNECTOR (Series B)

Pin Configuration

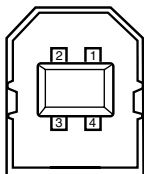

1	Vcc
2	- Data
3	+ Data
4	Ground

Optional Parts

The parts listed below are optionally supplied. When ordering those parts, give name and Type No. of it to the sales dealer.

- **COMPONENT-VGA Cable** **Type No. : POA-CA-COMPVGA**
- **SCART-VGA Cable** **Type No. : POA-CA-SCART**
- **MAC Adapter** **Type No. : POA-MACAP**

LIMITED WARRANTY

BOXLIGHT CORPORATION ("BOXLIGHT") warrants that each BOXLIGHT SP-10t ("the Product") sold hereunder will conform to and function in accordance with the written specifications of BOXLIGHT. Said limited warranty shall apply only to the first person or entity that purchases the Product for personal or business use and not for the purpose of distribution resale. Said warranty shall continue for a period of two (2) years from the date of such purchase. BOXLIGHT does not warrant that the Product will meet the specific requirements of the first person or entity that purchases the Product for personal or business use. Lamp is warranted for 120 days. Accessories are warranted for 1 year from date of purchase.

BOXLIGHT CORPORATION's liability for the breach of the foregoing limited warranty is limited to the repair or replacement of the Product or refund of the purchase price of the Product, at BOXLIGHT's sole option. To exercise the Purchaser's rights under the foregoing warranty, the Product must be returned at the Purchaser's sole cost and expense, to BOXLIGHT or any authorized service center provided, however, that the Product must be accompanied by a written letter explaining the problem and which includes (i) proof of purchase; (ii) the dealer's name; (iii) the model and serial number of the Product. **A return authorization number, issued by the BOXLIGHT customer service department, must also be clearly displayed on the outside of the shipping carton containing the Product.**

WARRANTY LIMITATION AND EXCLUSION

BOXLIGHT CORPORATION shall have no further obligation under the foregoing limited warranty if the Product has been damaged due to abuse, misuse, neglect, accident, unusual physical or electrical stress (unusual physical and electrical stress includes unusually long operation, exposure to smoke and other airborne contaminants), unauthorized modification, tampering, alterations, or service other than by BOXLIGHT or its authorized agents, causes other than from ordinary use or failure to properly use the Product in the application for which said Product is intended.

DISCLAIMER OR UNSTATED WARRANTIES

The warranty printed above is the only warranty applicable to this purchase.

All other warranties express or implied, including, but not limited to, the implied warranties or merchantability and fitness for a particular purpose are disclaimed. There are no warranties that extend beyond the face hereof and the foregoing warranty shall not be extended, altered or varied except by written instrument signed by BOXLIGHT CORPORATION.

LIMITATION OF LIABILITY

It is understood and agreed that BOXLIGHT's liability whether in contract, in tort, under any warranty, in negligence or otherwise shall not exceed the return of the amount of the purchase price paid by purchaser and under no circumstances shall BOXLIGHT be liable for special, indirect or consequential damages. The price stated for the Product is a consideration in limiting BOXLIGHT's liability. No action regardless of form, arising out of the agreement to purchase the product, may be brought by purchaser more than one year after the cause of action has accrued.



Boxlight
19332 Powder Hill Place
Poulsbo, WA 98370-7407 USA
www.boxlight.com
USA and Canada 800-762-5757
International 360-779-7901