

# XDM6825

## INSTALLATION/OWNER'S MANUAL

AM/FM/CD/MP3/WMA Receiver with Detach Face



iPlug™

Dual®



## Preparation

Please read entire manual before installation.

### Before You Start

- Disconnect negative battery terminal. Consult a qualified technician for instructions.
- Avoid installing the unit where it would be subject to high temperatures, such as from direct sunlight, or where it would be subject to dust, dirt or excessive vibration.

### Getting Started

- Remove 2 transit screws located on top of the unit.
- Insert the supplied keys into the slots as shown, and slide the unit out of the mounting sleeve.
- Install mounting sleeve into opening, bending tabs to secure.
- Connect wiring harness and antenna. Consult a qualified technician if you are unsure.
- Certain vehicles may require an installation kit and/or wiring harness adapter (sold separately).
- Test for correct operation and slide into mounting sleeve to secure.
- Snap trim ring into place.
- Mount the iplug™ adapter to any smooth clean surface using the supplied double-sided tape or #2 x 3/8" Phillips head screws.

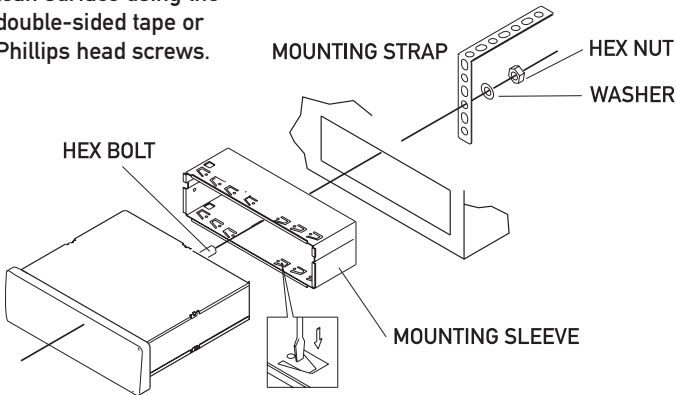
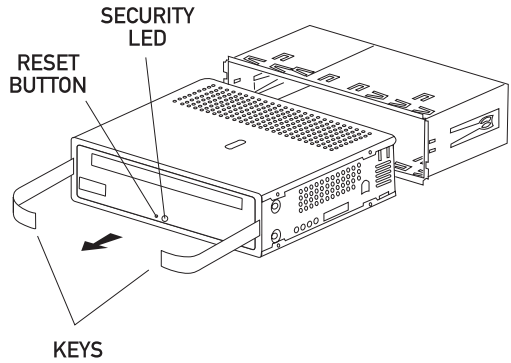

TYPICAL FRONT-LOAD DIN MOUNTING METHOD



# Wiring Diagram

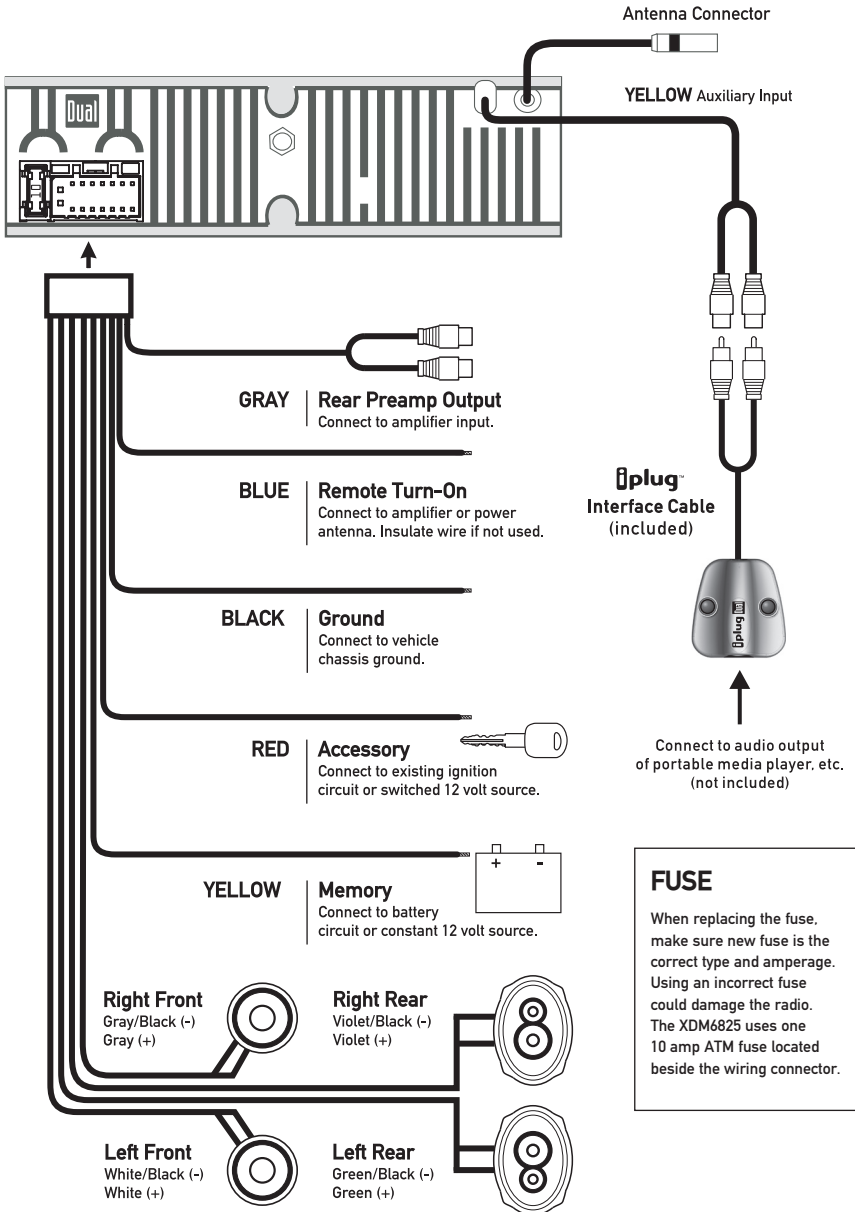



# Control Locations

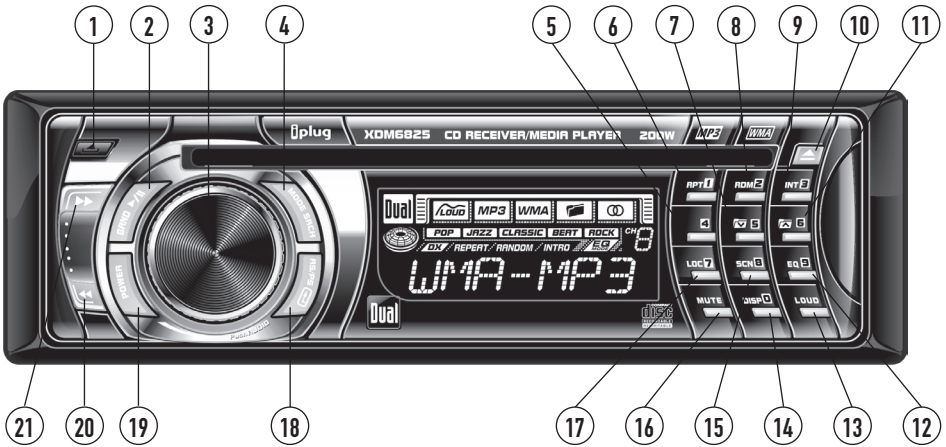

- |                        |                                 |
|------------------------|---------------------------------|
| 1 Release              | 12 EQ/9                         |
| 2 Band/Play/Pause      | 13 Loudness                     |
| 3 Volume               | 14 Display/0                    |
| 4 Mode/Search          | 15 Tuner Scan/8                 |
| 5 Preset 4             | 16 Mute                         |
| 6 Preset 1/Repeat      | 17 Local/Distance/7             |
| 7 Preset 5/Folder Down | 18 Auto Store/Preset Scan/Enter |
| 8 Preset 2/Random      | 19 Power                        |
| 9 Preset 3/Intro       | 20 Tune/Track Down              |
| 10 Eject               | 21 Tune/Track Up                |
| 11 Preset 6/Folder Up  |                                 |



The XDM6825 allows playback of your favorite MP3 and WMA files recorded on CD-R and CD-RW discs. Its powerful on-board DSP processor decodes the compressed audio while maintaining near-CD sound quality. An internal SRAM buffer provides ESP (Electronic Skip Protection) to virtually eliminate skipping and allows alphanumeric or direct track search - even while a song is currently playing!

## General Operation

<b>Faceplate Removal</b>	Press <b>RELEASE</b> and pull away from the left side to remove. To re-install, insert right side of faceplate first then push left side to secure.
<b>Semi-permanent Faceplate Installation</b>	Remove trim ring and install supplied #1 x 7/32" Phillips head screw through left side of mounting frame into faceplate.
<b>Power On/Off</b>	Press <b>POWER</b> or any other button (except eject) to turn the unit on. Inserting a disc will turn the unit on automatically. Press <b>POWER</b> to turn the unit off.
<b>Mode</b>	Press <b>MODE</b> to select between tuner, CD player and auxiliary input. Modes of operation are indicated in the display.
<b>Loudness</b>	Press <b>LOUD</b> to activate and deactivate the loudness contour curve. Activating this feature will enhance the bass and treble frequencies when listening to music at low volumes.
<b>Volume</b>	Adjust volume using rotary encoder (00-46).
<b>Programmable Turn-On Volume</b>	Press and hold <b>POWER</b> for 3 seconds to program currently selected volume level. "P-VOL" and the current volume level will momentarily appear in the display.
<b>Preset EQ Curves</b>	Press <b>EQ</b> to select between POP, JAZZ, CLASSIC, BEAT, ROCK and OFF (default) equalization curves. Any adjustment to the Bass or Treble settings automatically cancels the current EQ curve (if one is selected).
<b>Display</b>	Press <b>DISP</b> to select between clock and radio frequency (tuner mode), clock and CD track/elapsed time (CD mode), or clock and AUX (AUX mode).
<b>Set the Clock</b>	With the unit on, press and hold <b>DISP</b> until the clock begins to flash, then release. Press <b>TUNE</b> ◀◀ to adjust the hours and <b>TUNE</b> ▶▶ to adjust the minutes. Press <b>DISP</b> momentarily to save the selected time.
<b>12/24-hour Clock</b>	The clock will display 12-hour AM/PM time in USA frequency spacing mode (PM 10:00). In European frequency spacing mode, the clock will display 24-hour time (22:00).



## General Operation

<b>Programmable Display Priority</b>	<p>In tuner mode, press and hold <b>DISP</b> then press <b>TUNE</b> ►► to select function priority display. "FREQ" will momentarily appear in the display.</p> <p><b>Note:</b> "FUNC" will appear in CD or AUX modes. Radio frequency (tuner mode), CD track/elapsed time (CD mode) or AUX (AUX mode) will be displayed by default.</p> <p><b>Note:</b> When playing MP3/WMA files, the track number/elapsed time, track name, directory name, title, artist, album, year or comment will be displayed by default. Clock is accessed by pressing <b>DISP</b> momentarily.</p> <p>Press and hold <b>DISP</b> then press <b>TUNE</b> ◀◀ to select time display priority. "TIME" will momentarily appear in the display. Clock will be displayed by default. Radio frequency, CD track/elapsed time or MP3/WMA file information is accessed by pressing <b>DISP</b> momentarily.</p>
<b>Programmable Clock Priority</b>	<p>Programs unit to display clock/no clock when unit is off. Press and hold <b>MODE</b> then press <b>PRESET 1</b> to select clock priority on/off. "CLK ON" or "CLK OFF" will momentarily appear in the display.</p>
<b>Reset</b>	<p>Press and hold for more than 2 seconds to <b>RESET</b> the unit upon initial installation or if abnormal operation occurs. The reset button is located behind the faceplate.</p>
<b>Confirmation Beep</b>	<p>Press and hold <b>rotary encoder</b> for 3 seconds to turn confirmation beep on/off.</p>
<b>Mute</b>	<p>Press <b>MUTE</b> to silence the audio. "MUTE" will flash in the display. Press <b>MUTE</b> again to cancel.</p>

## General Operation

**Audio** Press **rotary encoder** to select between Volume (default), Bass, Treble, Balance & Fader.

→VOLUME →BASS→TREBLE→BALANCE→FADER

**Bass** Press **rotary encoder** until **BAS** appears  
Rotate encoder left/right to adjust  
( -6 minimum / +6 maximum)

**Treble** Press **rotary encoder** until **TRE** appears  
Rotate encoder left/right to adjust  
( -6 minimum / +6 maximum)

**Balance** Press **rotary encoder** until **BAL** appears  
Rotate encoder left/right to adjust  
(BAL L 12-BAL 00-BAL R 12)  
BAL 00 represents equal balance

**Fader** Press **rotary encoder** until **FAD** appears  
Rotate encoder left/right to adjust  
(FAD F 12-FAD 00-FAD R 12)  
FAD 00 represents equal fader

**Source Audio Memory** Individual Bass and Treble settings are retained in memory for AM, FM, CD, and AUX modes. This allows you to save the Bass and Treble settings separately for each mode.

**Example:**

FM tuner mode can have Bass +3 and Treble -1 while CD mode can have Bass +2 and Treble +2.

**Note:**

Any adjustment to the Bass or Treble settings automatically cancels the current EQ curve (if one is selected).



## Tuner Operation

<b>Seek Tuning</b>	Press <b>TUNE</b> ◀◀ or <b>TUNE</b> ▶▶ momentarily to seek the next strong station.
<b>Manual Tuning</b>	Press <b>TUNE</b> ◀◀ or <b>TUNE</b> ▶▶ for more than 2 seconds, then release. "MANUAL" will momentarily appear in the display. Press <b>TUNE</b> ◀◀ or <b>TUNE</b> ▶▶ momentarily to move radio frequency up or down one step at a time. Press and hold to advance quickly. If tuning is not adjusted for 5 seconds, the unit will return to seek tuning mode (default). "AUTO" will momentarily appear in the display.
<b>Scan Tuning</b>	Press <b>SCAN</b> to preview strong stations on the current band, pausing for 5 seconds at each. Press <b>SCAN</b> again to cancel.
<b>Local/Distance</b>	Press <b>LOC</b> to activate local tuning for strong station reception only. Press <b>LOC</b> again to cancel and resume Distance tuning (default).
<b>Band</b>	Press <b>BAND</b> to select between FM1, FM2, FM3, AM1 and AM2 bands.
<b>Frequency Spacing</b>	Press and hold <b>BAND</b> then press <b>TUNE</b> ◀◀ to select European frequency spacing. Press and hold <b>BAND</b> then press <b>TUNE</b> ▶▶ to select USA frequency spacing (default).
<b>Storing and Recalling Station Presets</b>	<p>Up to 18 FM stations and 12 AM stations can be stored. To store a station, select the desired band and station. Press and hold the desired preset button (1-6) for more than 2 seconds. When stored, the preset number will appear in the display. The station can be recalled anytime by pressing the corresponding preset button.</p> <p>Note: Function buttons 7, 8, 9 and 0 apply to MP3 and WMA playback only.</p>
<b>Automatically Store Stations</b>	Press <b>AS/PS</b> for more than 2 seconds to automatically store the six strongest stations in the current band. Automatic Local/Distance is activated during the initial band scan.
<b>Preset Scan</b>	Press <b>AS/PS</b> for less than 2 seconds to scan presets 1-6 on the current band, pausing for 5 seconds at each. Press <b>AS/PS</b> again to cancel.



## CD Player Operation

<b>Insert CD</b>	With the label facing up, insert a standard size CD into the CD slot. The CD will automatically begin playback.
<b>Eject CD</b>	Press <b>EJECT</b> to eject the CD. The unit will change to previous mode of operation (AM, FM, or auxiliary input). If the disc is not removed within 10 seconds, the unit will reload the disc. The unit does not have to be turned on to eject CD.
<b>Track Select</b>	Press <b>TRACK ►►</b> to skip to the beginning of the next track. Press <b>TRACK ◄◄</b> to return to the beginning of the current track. Pressing <b>TRACK ◄◄</b> again skips to the beginning of the previous track.
<b>Fast Forward and Reverse</b>	Press and hold <b>TRACK ►►</b> or <b>TRACK ◄◄</b> to fast forward or reverse a track.
<b>Pause</b>	Press <b>►/  </b> to temporarily stop CD playback. Press <b>►/  </b> again to resume playback.
<b>Intro</b>	Press <b>INT</b> to play the first 10 seconds of each track. Press <b>INT</b> again to cancel.
<b>Repeat</b>	Press <b>RPT</b> to continuously repeat selected track. Press <b>RPT</b> again to cancel.
<b>Random</b>	Press <b>RDM</b> to play all tracks in random order. Press <b>RDM</b> again to cancel. Random mode is retained in memory when selecting between tuner, CD player and auxiliary input modes and when the unit is turned on/off.
<b>CD-R/CD-RW Compatibility</b>	<p>Some CD-Rs and CD-RWs may be incompatible with this unit, depending on media type and recording method. In addition, the following CDs may be incompatible with this unit:</p> <p>CDs exposed to extreme temperatures or direct sunlight for extended periods of time. CDs recorded in which a recording session failed or a re-recording was attempted and, or encrypted or copy-protected CDs which do not conform to the audio CD-DA red book recording standard.</p>

---

## CD Player Operation - MP3/WMA Files

### Playing an MP3/WMA Disc

When an MP3/WMA encoded disc is first inserted, "READING" will appear in the display. Depending on the number of files and folders, this may take several seconds.

 **MP3 Icon**

The  icon will illuminate anytime a valid MP3 encoded disc is inserted and flash in MP3 search/navigate modes.

 **WMA Icon**

The  icon will illuminate anytime a valid WMA encoded disc is inserted and flash in WMA search/navigate modes.

 **Folder Icon**

The  icon will illuminate anytime a folder is selected in the file/folder search modes.

### Displaying Information

Press **DISP** to select between track number/elapsed time (default), clock, track name, directory name, title, artist, album, year and comment.

"NO ID3 TAG" will be displayed if the MP3 file contains no ID3 tag information.

"UNKNOWN" will be displayed if the WMA file contains no WMA tag information.

"ROOT" will be displayed if the directory name of a root folder is not labeled.

### Character Support

Maximum character display information

- Track name – 32 character maximum
- Directory name – 32 character maximum
- \*Song title – 30 character maximum
- \*Artist name – 30 character maximum
- \*Album name – 30 character maximum
- \*Year – 4 character maximum
- \*Comment – 28 character maximum

\*Song title, Artist Name, Album name, Year and Comment will only be displayed if included with the MP3/WMA file.

When referring to MP3/WMA playback, the following terms are synonymous:

- File name and track name
- Folder name and directory name

## CD Player Operation - MP3/WMA Files

Refer to the following button function table when selecting, searching or navigating MP3/WMA files and folders:

MP3/WMA Button Function Table	
Button	Function
SRCH	Direct Select, Search and Navigate Modes
	Enter/Confirm
Preset 1	A, B, C, 1
Preset 2	D, E, F, 2
Preset 3	G, H, I, 3
Preset 4	J, K, L, 4
Preset 5	M, N, O, 5
Preset 6	P, Q, R, 6
7	S, T, U, 7
8	V, W, X, 8
9	Y, Z, /, 9
0	-, _, +, 0
Press Rotary Encoder	Character Shift
Rotate Rotary Encoder	Character Select (A, B, C ~ 8, 9, 0)
MUTE	Character Backspace

### Direct Select, Search and Navigate Modes

Press **SRCH** for more than 3 seconds, to select between the following modes:

- Direct File Select
- Alphanumeric File or Folder Search
- File or Folder Navigate

### Direct File Select Step 1





Press **SRCH** for more than 3 seconds, then release. "MP3 T\*" or "WMA T\*" will flash in the display. Use the buttons in the above table (3 keystroke maximum input), or the rotary encoder to enter the desired file number.

### Step 2



Press  to confirm the selected file number or wait for the input cycle to time out (approximately 5 seconds). If the file is not available, "NO FILE" will be displayed momentarily and the current file will continue to play.



## CD Player Operation - MP3/WMA Files





- Alphanumeric File or Folder Search**
- Step 1** Press **SRCH** for more than 3 seconds, then release. Press **SRCH** again, an "\*" will flash in the display. Use the buttons in the table on page 11 (32 character maximum input) or the rotary encoder to enter the desired alphanumeric search characters. Press **rotary encoder** to advance one character to the right.
- Step 2** Press  to initiate the selected alphanumeric search.
- Step 3** Turn the rotary encoder to preview the search results. If the search returns a folder, the  icon will illuminate.
- Step 4** Press  to select the desired file or folder. If a folder is selected, "/" will be displayed. Turn the rotary encoder to the right to begin searching files in the folder.
- Step 5** Press  to select the desired file within the folder.

**Note:**  
If the file is not available, "NO FILE" will be displayed momentarily and the current file will continue to play.

- File/Folder Navigate**
- Step 1** Press **SRCH** for more than 3 seconds, then release. Press **SRCH** again two times to navigate files/folders on the disc. The current folder name will scroll one time followed by available files and folders.
- Step 2** Turn the rotary encoder to preview files/folders in the current folder. If a folder is selected, the  icon will illuminate.
- Step 3** Press  to select the desired file or folder. If a folder is selected, "/" will be displayed. Turn the rotary encoder to the right to begin searching files in the folder.
- Step 4** Press  to select the desired file within the folder.

**\*Folder Access (Up one level)** When navigating folders (and "/" is displayed), press **rotary encoder** to access the previous level (up one level).  
\*Only available on MP3/WMA discs recorded with more than one folder.

## CD Player Operation - MP3/WMA Files

<b>Navigating Note</b>	After navigating by direct select, alphanumeric search or file/folder navigate modes, the track number and elapsed time will be displayed by default. Press DISP momentarily to select clock, track name, directory name, title, artist, album, year or comment.
<b>*Folder Access</b>	<p>Press  to select the previous folder. Press  to select the next folder.</p> <p>*Folder access is only available on MP3/WMA discs recorded with more than one folder.</p>
<b>File Repeat</b>	Press RPT momentarily to continuously repeat selected file. Press RPT again to cancel.
<b>File Repeat (Current Folder Only)</b>	Press RPT for more than 2 seconds to consecutively repeat all files in the current folder only. The  icon will appear in the display when in folder repeat mode. Press RPT again to cancel.
<b>Disc Random</b>	Press RDM momentarily to play all files on entire disc in random order. Press RDM again to cancel.
<b>Folder Random</b>	Press RDM for more than 2 seconds to play all files in current folder only in random order. The  icon will appear in the display when in folder random mode. Press RDM again to cancel.
<b>Disc Intro</b>	Press INT momentarily to play the first 10 seconds of each file on the entire MP3/WMA disc. Press INT again to cancel.
<b>Folder Intro</b>	Press INT for more than 2 seconds to play the first 10 seconds of each file in the current folder only. The  icon will appear in the display when in folder intro mode. Press INT again to cancel.
	<p><b>Note:</b> File repeat (current folder only), folder random and folder intro is only available on MP3/WMA discs recorded with more than one folder.</p>



## CD Player Operation - MP3/WMA Files

### Media Compatibility

The following types of discs/files are compatible:

- CD-ROM (ISO), CD-R, CD-RW
- CD-DA
- MP3 data
- WMA data

The following types of discs/files are not compatible:

- WMA files that are protected by DRM (Digital Rights Management).
- WMA lossless format
- Discs recorded with Track At Once or packet writing
- MP3 PRO format
- MP3 playlists
- WAV format

### Playback Order

MP3/WMA playback sequence is based on recorded order of files and begins in the root folder of the disc. Any empty folders or folders that do not include MP3/WMA files are skipped. This unit may not play files in the order they were recorded in. Refer to your recording software's user's manual for more information.

### Compatible Recording Formats

- ISO9660 level 1
- ISO9660 level 2
- Yellow Book MODE 1
- Yellow Book MODE 2 FORM 1
- Multi session
- Maximum folders and files - 256
- Maximum folder levels - 8
- MPEG-1/2/2.5 Audio Layer-3

ISO9660 standards:

- Maximum nested folder depth is 8 (including the root folder).
- Valid characters for folder/file names are letters A-Z (all caps), numbers 0-9, and “\_” (underscore). Some characters may not be displayed correctly, depending on the character type.
- This device can play back discs in Joliet, Romeo, and other standards that conform to ISO9660. MP3/WMA written in the formats other than the above may not play and/or their file names or folder names may not be displayed properly.



## CD Player Operation - MP3/WMA Files

### Additional MP3/WMA Information

An internal buffer provides ESP (Electronic Skip Protection) to virtually eliminate skipping.

When playing a disc recorded with regular audio files (CD-DA or .WAV) and MP3/WMA files, the unit will play the MP3/WMA files only.

Only MP3 files with filename extension (.mp3) can be played.  
Only WMA files with filename extension (.wma) can be played.

Do not attempt to play discs which contain non-MP3/WMA files with the MP3/WMA extension.

### Sampling Frequency Rates

#### MP3

8kHz ~ 48kHz

#### WMA

32kHz ~ 48kHz

### Transfer Bit rates

#### MP3

8kbps ~ 320kbps constant  
Variable bit rates

#### WMA

32kbps ~ 192kbps constant  
Variable bit rates

Note:

Some files may not play or be displayed correctly, depending on sampling rates and bit rates.

### MP3 Tag Display

ID3 tags Version 1.x

This model will not display ID3 Version 2.0 or greater tags.

### Recommended Settings

For best results, use the following settings when burning an MP3 disc:

128kbps or higher constant bit rate

44.1kHz or higher sampling frequency

For best results, use the following settings when burning a WMA disc:

64kbps or higher constant bit rate

32kHz or higher sampling frequency



## Limited One Year Warranty

This warranty gives you specific legal rights. You may also have other rights which vary from state to state.

Dual Electronics Corp. warrants this product to the original purchaser to be free from defects in material and workmanship for a period of one year from the date of the original purchase.

Dual Electronics Corp. agrees, at our option, during the warranty period, to repair any defect in material or workmanship or to furnish an equal new, renewed or comparable product (whichever is deemed necessary) in exchange without charges, subject to verification of the defect or malfunction and proof of the date of purchase. Subsequent replacement products are warranted for the balance of the original warranty period.

**Who is covered?** This warranty is extended to the original retail purchaser for products purchased and used in the U.S.A.

**What is covered?** This warranty covers all defects in material and workmanship in this product. The following are not covered: installation/removal costs, damage resulting from accident, misuse, abuse, neglect, product modification, improper installation, incorrect line voltage, unauthorized repair or failure to follow instructions supplied with the product, or damage occurring during return shipment of the product.

### What to do?

1. Before you call for service, check the troubleshooting guide in your owner's manual. A slight adjustment of any custom controls in your owner's manual may save you a service call.
2. If you require service during the warranty period, you must carefully pack the product (preferably in the original package) and ship it by prepaid transportation with a copy of the original receipt from the retailer to an authorized service center.
3. Please describe your problem in writing and include your name, a USA return shipping address (P.O. Box not acceptable), and a daytime phone number with your shipment.
4. For more information and for the location of the nearest authorized service center please contact us by one of the following methods:

- Call us toll-free at 1-866-382-5476
- E-mail us at [cs@dualav.com](mailto:cs@dualav.com)

**Exclusion of Certain Damages:** This warranty is exclusive and in lieu of any and all other warranties, expressed or implied, including without limitation the implied warranties of merchantability and fitness for a particular purpose and any obligation, liability, right, claim or remedy in contract or tort, whether or not arising from the company's negligence, actual or imputed. No person or representative is authorized to assume for the company any other liability in connection with the sale of this product. In no event shall the company be liable for indirect, incidental or consequential damages.



## Specifications

<b>CD Player</b>	Frequency response: <b>10Hz-20kHz</b> Channel separation @ 1kHz: <b>&gt;65dB</b> D/A converter: <b>1 Bit</b>
<b>FM Tuner</b>	Tuning range: <b>87.5MHz-107.9MHz</b> Usable sensitivity: <b>8.5dBf</b> 50dB quieting sensitivity: <b>10dBf</b> Stereo separation @ 1kHz: <b>40dB</b> Frequency response: <b>30Hz-13kHz</b>
<b>AM Tuner</b>	Tuning range: <b>530kHz-1710kHz</b> Usable sensitivity: <b>22uV</b> Frequency response: <b>30Hz-2.2kHz</b>
<b>General</b>	Operating voltage: <b>11-16 VDC, negative ground</b> Speaker output impedance: <b>4~8 ohms</b> Line output voltage: <b>2 Volts</b> Dimensions: <b>7" x 7" x 2" (178 x 178 x 51 mm)</b>

Design and specifications subject to change without notice.



### CEA-2006 Power Standard Specifications (reference: 14.4VDC +/- 0.2V, 20Hz~20kHz)

Power Output: 15 Watts RMS x 4 channels at 4 ohms and  $\leq 1\%$  THD+N  
Signal to Noise Ratio: 80dBA (reference: 1 watt into 4 ohms)



# Troubleshooting

Problem	Cause	Action
Unit will not turn on (no power)	Yellow wire not connected or incorrect voltage Red wire not connected or incorrect voltage	Check connections for proper voltage (11~16VDC)
	Black wire not connected	Check connection to ground
	Fuse blown	Replace fuse
Unit has power (but no sound)	Speaker wires not connected	Check connections at speakers
	One or more speaker wires touching each other or touching chassis ground	Insulate all bare speaker wires from each other and chassis ground
Unit blows fuses	Yellow or red wire touching chassis ground	Check for pinched wire
	Speaker wires touching chassis ground	Check for pinched wire
	Incorrect fuse rating	Use fuse with correct rating
Excessive skipping	Unit is not mounted correctly or backstrap is not secure	Check mounting sleeve and backstrap support
	Physical defect in media (CD, CD-R or CD-RW)	Check media for scratches
ERROR-01 appears on display	Disc read error	Press eject or RESET
ERROR-02 appears on display	Focus error or disc is in upside down	Press eject or RESET
ERROR-03 appears on display	FAT error	Press eject or RESET
ERROR-04 appears on display	MP3/WMA decode error	Press eject or RESET
PROTECT appears on display	The WMA file is copy-protected by DRM (Digital Rights Management)	Write disc using WMA files that are not copy-protected
NO FILE appears on display	Selected file is not available in direct or alphanumeric search modes	Repeat search using valid parameters
INVALID appears on display	The WMA file is copy-protected by DRM (Digital Rights Management)	Write disc using valid audio files with .mp3 or .wma file extensions
Unit will not accept a disc	CD mechanism position out of alignment	Press EJECT for 3 seconds to reset CD mechanism position
	CD transit screws still in place	Remove 2 transit screws located on top of the unit





Dual Electronics Corp.  
Toll Free: 1-866-626-7863

[www.dualav.com](http://www.dualav.com)

©2006 Dual Electronics Corp. All rights reserved.  
Windows Media and the Windows logo are trademarks, or  
registered trademarks of Microsoft Corporation in the United  
States and or other countries.

NSA0306-V02