

# Owner's Manual

Please read before using this equipment.

## DVD/CD Player

# EWD7004



EMERSON AND THE G-CLEF LOGO ARE REGISTERED TRADEMARKS OF EMERSON RADIO CORP., PARSIPPANY, NEW JERSEY, U.S.A.

INSTRUCCIONES EN ESPAÑOL INCLUIDAS.

### Supplied Accessory

- Remote control (NB000UD/ NB050UD) with two AA batteries
- Audio/Video cables (WPZ0102TM015/ WPZ0102LTE01)
- Owner's Manual (0VMN03999)

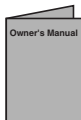
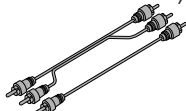
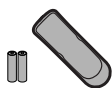

### Before Using Your DVD player

If your TV has AUDIO/VIDEO input jacks, see the section "Connections" on pages 6–7. If not, it is still possible to connect this DVD player to your TV by using a STEREO AUDIO/VIDEO RF Modulator (commercially available.) In this case, follow the instructions below.

- 1) Connect the AUDIO/VIDEO output jacks of this DVD player to the AUDIO/VIDEO input jacks of your RF Modulator by audio and video cables.
- 2) The antenna input jack of your TV may have been already occupied. If so, disconnect the RF cable from your TV, and then connect the RF cable to your RF Modulator (usually marked "ANT IN".)
- 3) Connect your RF modulator to your TV by another RF cable.
- 4) Set your RF modulator's channel 3/4 switch to either 3 or 4, whichever the TV channel is least used in your area. If your RF modulator has a Modulator/Antenna switch, set it according to your RF modulator's manual.
- 5) Turn on your TV and choose the same channel as you set the RF modulator's channel 3/4 switch to.  
For more details, follow the instructions supplied with the RF Modulator.

### Hint

- The quality of picture may become poor if this DVD player is connected to an RF Modulator.

### Table of Contents

#### Precautions

Laser Safety . . . . .	2
■ <b>Important Safeguards</b> . . . . .	<b>3</b>
Installation Location . . . . .	4
Avoid the Hazards of Electrical Shock and Fire . . . . .	4
Moisture Condensation Warning . . . . .	4
About Copyright . . . . .	4
Symbol Used in This Manual . . . . .	4
Maintenance . . . . .	4
■ <b>About the Discs</b> . . . . .	<b>5</b>
Playable Discs . . . . .	5
Unplayable Discs . . . . .	5

#### Setup

■ <b>Connections</b> . . . . .	<b>6</b>
Connection to a TV . . . . .	6
Connection to an Audio System . . . . .	7
Rear Terminals . . . . .	7
■ <b>About the Remote Control</b> . . . . .	<b>8</b>
Remote Control . . . . .	8
Installing the Batteries for the Remote Control . . . . .	8

#### Functions

■ <b>Playback</b> . . . . .	<b>9</b>
■ <b>MP3 Playback</b> . . . . .	<b>10</b>
■ <b>The On-Screen Display</b> . . . . .	<b>10</b>
■ <b>Search Function</b> . . . . .	<b>11</b>
Track Search . . . . .	11
Title / Chapter Search . . . . .	11
Time Search . . . . .	11
■ <b>Marker Setup</b> . . . . .	<b>11</b>
■ <b>Repeat / Random / Programmed Playback</b> . . . . .	<b>12</b>
Repeat Playback . . . . .	12
Repeat A-B Playback . . . . .	12
Random Playback . . . . .	12
Programmed Playback . . . . .	12
■ <b>Special Settings</b> . . . . .	<b>13</b>
Subtitle Language . . . . .	13
Audio Language . . . . .	13
Camera Angles . . . . .	13
Black Level Setting . . . . .	13
Stereo Sound mode . . . . .	13
Virtual Surround . . . . .	13
■ <b>DVD Set Up</b> . . . . .	<b>14</b>
LANGUAGE Setting . . . . .	14
DISPLAY Setting . . . . .	15
AUDIO Setting . . . . .	15
PARENTAL Setting . . . . .	16
To return the All Selections of SET UP (except for PARENTAL) to the Default Setting . . . . .	16

#### Information

■ <b>Troubleshooting Guide</b> . . . . .	<b>17</b>
■ <b>Specifications</b> . . . . .	<b>18</b>
■ <b>Language List</b> . . . . .	<b>18</b>
■ <b>Limited Warranty</b> . . . . .	<b>18</b>

<b>Español</b> . . . . .	<b>19</b>
--------------------------	-----------

<b>Quick Use Guide</b> . . . . .	<b>20</b>
----------------------------------	-----------

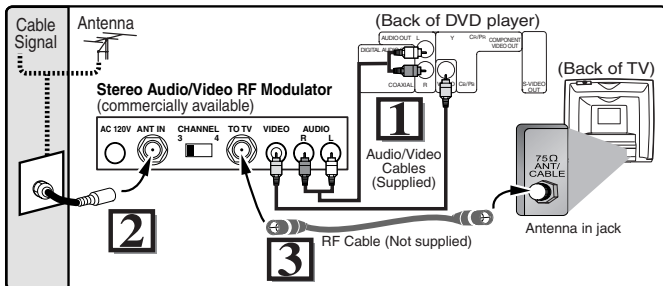

If you need additional operating assistance after reading this owner's manual or to order replacement accessories, please call  
**TOLL FREE : 1-800-256-2487**  
 or visit our web site at <http://www.funai-corp.com>

Precautions

Setup

Functions

Information

Español

# Precautions

**WARNING:** TO REDUCE THE RISK OF FIRE OR ELECTRIC SHOCK, DO NOT EXPOSE THIS APPLIANCE TO RAIN OR MOISTURE.



## CAUTION

RISK OF ELECTRIC SHOCK  
DO NOT OPEN



The lightning flash with arrowhead symbol, within an equilateral triangle, is intended to alert the user to the presence of uninsulated "dangerous voltage" within the product's enclosure that may be of sufficient magnitude to constitute a risk of electric shock to persons.



The exclamation point within an equilateral triangle is intended to alert the user to the presence of important operating and maintenance (servicing) instructions in the literature accompanying the appliance.

## CAUTION:

TO REDUCE THE RISK OF ELECTRIC SHOCK, DO NOT REMOVE COVER (OR BACK). NO USER SERVICEABLE PARTS INSIDE. REFER SERVICING TO QUALIFIED SERVICE PERSONNEL.

## Laser Safety

This unit employs a laser. Only a qualified service person should remove the cover or attempt to service this device, due to possible eye injury.

**CAUTION:** USE OF CONTROLS OR ADJUSTMENTS OR PERFORMANCE OF PROCEDURES OTHER THAN THOSE SPECIFIED HEREIN MAY RESULT IN HAZARDOUS RADIATION EXPOSURE.

**CAUTION:** VISIBLE AND INVISIBLE LASER RADIATION WHEN OPEN AND INTERLOCK DEFEATED. DO NOT STARE INTO BEAM.

**LOCATION:** INSIDE, NEAR THE DECK MECHANISM.

**FCC WARNING-** This equipment may generate or use radio frequency energy. Changes or modifications to this equipment may cause harmful interference unless the modifications are expressly approved in the instruction manual. The user could lose the authority to operate this equipment if an unauthorized change or modification is made.

## RADIO-TV INTERFERENCE

This equipment has been tested and found to comply with the limits for a Class B digital device, pursuant to Part 15 of the FCC Rules. These limits are designed to provide reasonable protection against harmful interference in a residential installation. This equipment generates, uses, and can radiate radio frequency energy and, if not installed and used in accordance with the instructions, may cause harmful interference to radio communications. However, there is no guarantee that interference will not occur in a particular installation. If this equipment does cause harmful interference to radio or television reception, which can be determined by turning the equipment off and on, the user is encouraged to try to correct the interference by one or more of the following measures:

- 1) Reorient or relocate the receiving antenna.
- 2) Increase the separation between the equipment and receiver.
- 3) Connect the equipment into an outlet on a circuit different from that to which the receiver is connected.
- 4) Consult the dealer or an experienced radio/TV technician for help.

**This Class B digital apparatus complies with Canadian ICES-003.**

**Cet appareil numérique de la classe B est conforme à la norme NMB-003 du Canada.**

**CAUTION: TO PREVENT ELECTRIC SHOCK, MATCH WIDE BLADE OF PLUG TO WIDE SLOT, FULLY INSERT.**

**ATTENTION: POUR ÉVITER LES CHOC ÉLECTRIQUES, INTRODUIRE LA LAME LA PLUS LARGE DE LA FICHE DANS LA BORNE CORRESPONDANTE DE LA PRISE ET POUSSER JUSQU'AU FOND.**

## A NOTE ABOUT RECYCLING

This product's packaging materials are recyclable and can be reused. Please dispose of any materials in accordance with your local recycling regulations.

Batteries should never be thrown away or incinerated but disposed of in accordance with your local regulations concerning chemical wastes.

## Make your contribution to the environment!!!

- Used up batteries do not belong in the dust bin.
- You can dispose of them at a collection point for used up batteries or special waste. Contact your council for details.



For Customer Use:

Read carefully the information located at the bottom of this unit and enter below the Serial No. Retain this information for future reference.

Model No. \_\_\_\_\_

Serial No. \_\_\_\_\_

# Important Safeguards

- 1) Read Instructions - All the safety and operating instructions should be read before the product is operated.
  - 2) Retain Instructions - The safety and operating instructions should be retained for future reference.
  - 3) Heed Warnings - All warnings on the product and in the operating instructions should be adhered to.
  - 4) Follow Instructions - All operating and use instructions should be followed.
  - 5) Cleaning - Unplug this product from the wall outlet before cleaning. Do not use liquid cleaners or aerosol cleaners. Use a damp cloth for cleaning.
  - 6) Attachments - Do not use attachments not recommended by the product manufacturer as they may cause hazards.
  - 7) Water and Moisture - Do not use this product near water - for example, near a bath tub, wash bowl, kitchen sink, or laundry tub; in a wet basement; or near a swimming pool; and the like.
  - 8) Accessories - Do not place this product on an unstable cart, stand, tripod, bracket, or table. The product may fall, causing serious injury to a child or adult, and serious damage to the product. Use only with a cart, stand, tripod, bracket, or table recommended by the manufacturer, or sold with the product. Any mounting of the product should follow the manufacturer's instructions, and should use a mounting accessory recommended by the manufacturer.
- PORTABLE CART WARNING  
(Symbol provided by RETAC)



S3125A
- 9) A product and cart combination should be moved with care. Quick stops, excessive force, and uneven surfaces may cause the product and cart combination to overturn.
  - 10) Ventilation - Slots and openings in the cabinet are provided for ventilation and to ensure reliable operation of the product and to protect it from overheating, and these openings must not be blocked or covered. The openings should never be blocked by placing the product on a bed, sofa, rug, or other similar surface. This product should not be placed in a built-in installation such as a bookcase or rack unless proper ventilation is provided or the manufacturer's instructions have been adhered to.
  - 11) Power Sources - This product should be operated only from the type of power source indicated on the marking label. If you are not sure of the type of power supply to your home, consult your product dealer or local power company. For products intended to operate from battery power, or other sources, refer to the operating instructions.
  - 12) Grounding or Polarization - This product may be equipped with a polarized alternating-current line plug (a plug having one blade wider than the other). This plug will fit into the power outlet only one way. This is a safety feature. If you are unable to insert the plug fully into the outlet, try reversing the plug. If the plug should still fail to fit, contact your electrician to replace your obsolete outlet. Do not defeat the safety purpose of the polarized plug.
  - 13) Power-Cord Protection - Power-supply cords should be routed so that they are not likely to be walked on or pinched by items placed upon or against them, paying particular attention to cords at plugs, convenience receptacles, and the point where they exit from the product.
  - 14) Lightning - For added protection for this product during a lightning storm, or when it is left unattended and unused for long periods of time, unplug it from the wall outlet. This will prevent damage to the product due to lightning and power-line surges.
  - 15) Power lines - An outside antenna system should not be located in the vicinity of overhead power lines or other electric light or power circuits, or where it can fall into such power lines or circuits. When installing an outside antenna system, extreme care should be taken to keep from touching such power lines or circuits as contact with them might be fatal.
  - 16) Overloading - Do not overload wall outlets, extension cords, or integral convenience receptacles as this can result in a risk of fire or electric shock.
  - 17) Object and Liquid Entry - Never push objects of any kind into this product through openings as they may touch dangerous voltage points or short-out parts that could result in a fire or electric shock. Never spill liquid of any kind on the product.
  - 18) Servicing - Do not attempt to service this product yourself as opening or removing covers may expose you to dangerous voltage or other hazards. Refer all servicing to qualified service personnel.
  - 19) Damage Requiring Service - Unplug this product from the wall outlet and refer servicing to qualified service personnel under the following conditions:
    - a) When the power-supply cord or plug is damaged,
    - b) If liquid has been spilled, or objects have fallen into the product,
    - c) If the product has been exposed to rain or water,
    - d) If the product does not operate normally by following the operating instructions. Adjust only those controls that are covered by the operating instructions as an improper adjustment of other controls may result in damage and will often require extensive work by a qualified technician to restore the product to its normal operation,
    - e) If the product has been dropped or damaged in any way.
    - f) When the product exhibits a distinct change in performance - this indicates a need for service.
  - 20) Replacement Parts - When replacement parts are required, be sure the service technician has used replacement parts specified by the manufacturer or have the same characteristics as the original part. Unauthorized substitutions may result in fire, electric shock, or other hazards.
  - 21) Safety Check - Upon completion of any service or repairs to this product, ask the service technician to perform safety checks to determine that the product is in proper operating condition.
  - 22) Heat - The product should be situated away from heat sources such as radiators, heat registers, stoves, or other products (including amplifiers) that produce heat.

## Installation Location

For safety and optimum performance of this unit:

- Install the unit in a horizontal and stable position. Do not place anything directly on top of the unit. Do not place the unit directly on top of the TV.
- Shield it from direct sunlight and keep it away from sources of intense heat. Avoid dusty or humid places. Avoid places with insufficient ventilation for proper heat dissipation. Do not block the ventilation holes on the sides of the unit. Avoid locations subject to strong vibration or strong magnetic fields.

## Avoid the Hazards of Electrical Shock and Fire

- Do not handle the power cord with wet hands.
- Do not pull on the power cord when disconnecting it from AC wall outlet. Grasp it by the plug.
- If, by accident, water is spilled on this unit, unplug the power cord immediately and take the unit to our Authorized Service Center for servicing.

## Moisture Condensation Warning

Moisture condensation may occur inside the unit when it is moved from a cold place to a warm place, or after heating a cold room or under conditions of high humidity. Do not use this unit at least for 2 hours until its inside gets dry.

## About Copyright

Unauthorized copying, broadcasting, public performance and lending of discs are prohibited. This product incorporates copyright protection technology that is protected by method claims of certain U.S. patents and other intellectual property rights owned by Macrovision Corporation and other rights owners. Use of this copyright protection technology must be authorized by Macrovision Corporation, and is intended for home and other limited viewing uses only unless otherwise authorized by Macrovision Corporation. Reverse engineering or disassembly is prohibited.

## Symbol Used in This Manual

The following symbols appear in some headings and notes in this manual.



: Description refers to playback of DVD-Video discs.



: Description refers to playback of Audio CDs.



: Description refers to playback of MP3 files.

## Maintenance

### SERVICING

- Please refer to relevant topics on the Troubleshooting Guide on page 17 before you return the product.
- When this unit become inoperative, do not try to correct the problem by yourself. There are no user-serviceable parts inside. Turn off, unplug this unit, and please call our help line mentioned on the front page to locate an Authorized Service Center.

### CLEANING THE CABINET

- Use a soft cloth slightly moistened with a mild detergent solution. Do not use a solution containing alcohol, spirits, ammonia or abrasive.

### CLEANING DISCS

- When a disc becomes dirty, clean it with a cleaning cloth. Wipe the disc from the center out. Do not wipe in a circular motion.
- Do not use solvents such as benzine, thinner, commercially available cleaners, detergent, abrasive cleaning agents or antistatic spray intended for analogue records.

### CLEANING THE DISC LENS

- If this unit still does not perform properly although you refer to the relevant sections and to "TROUBLESHOOTING GUIDE" in this Owner's Manual, the laser optical pickup unit may be dirty. Consult your dealer or an Authorized Service Center for inspection and cleaning of the laser optical pickup unit.

### DISC HANDLING

- Handle the discs so that fingerprints and dust do not adhere to the surfaces of the discs.
- Always store a disc in its protective case when it is not used.

# About the Discs

## Playable Discs

Playable discs	Mark (logo)	Region code	Recorded signals	Disc size	Disc types
DVD-Video * 1,2,4,6		or	Digital video (MPEG2)	12 cm or 8cm	<p><b>Example</b></p> <p>Title 1   Title 2</p> <p>Chapter 1   Chapter 2   Chapter 3   Chapter 4   Chapter 1   Chapter 2</p>
DVD-R DVD-RW * 1,2,3,4,5,6	 	-			
DVD+R DVD+RW * 1,2,3,4,5,6	 DVD+ReWritable	-			
Audio CD * 4,6		-	Digital audio or MP3	12 cm or 8cm	<p><b>Example</b></p> <p>Track 1   Track 2   Track 3   Track 4   Track 5   Track 6</p>
CD-R CD-RW * 4,5,6	 				<p><b>Example</b></p> <p>Group 1   Group 2</p> <p>Track 1   Track 2   Track 3   Track 4   Track 5   Track 6</p>

**If you cannot play back a disc which bears one of the marks above, check the following notes.**

- \*1: This unit conforms to the NTSC color system. Discs recorded in other color systems such as PAL cannot be played back.
- \*2: Certain DVD-Video discs do not operate as described in this manual due to the intentions of the disc's producers.
- \*3: Only the discs which have been recorded in the video format and finalized can be played back. Discs unfinalized or recorded in the video recording format cannot be played back. Depending on the recording status of a disc, the disc may not be played back at all or normally (the picture or sound may not be smooth, etc.).
- \*4: Scratched or stained discs may not be played back.
- \*5: Some discs cannot be played back because of incompatible recording conditions, characteristics of the recorder or special properties of discs.
- \*6: You can play back discs which bear the marks above. If you use nonstandardized discs, this unit may not play them back. Even if they are played back, the sound or video quality will be compromised.

## Unplayable Discs

- On the following discs, only the sound can be heard (picture cannot be viewed).  
CDV  
CD-G
- NEVER play back the following discs. Otherwise, malfunction may result!  
DVD-RAM  
CD-I  
Photo CD  
Video CD  
DVD with region codes other than 1 or ALL  
DTS-CD  
DVD-ROM for personal computers  
CD-ROM for personal computers
- On the following disc, the sound MAY NOT be heard.  
Super Audio CD  
Note: Only the sound recorded on the normal CD layer can be delivered.  
The sound recorded on the high density Super Audio CD layer cannot be delivered.
- Any other discs without compatibility indications.

# Setup

## Connections

If your TV has AUDIO/VIDEO input jacks, see the following instructions. If not, see the section “Before using your DVD player” on the front page.

### Connection to a TV

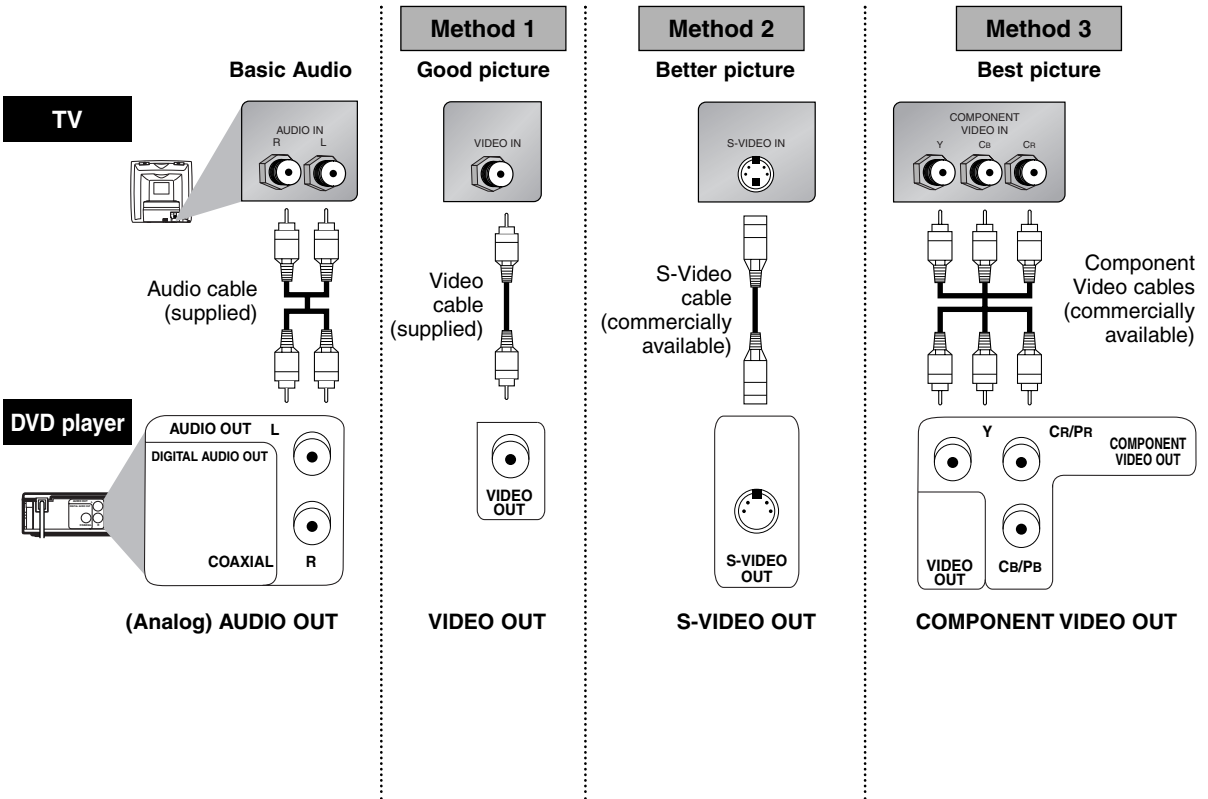

#### Note

- Connect this unit directly to the TV. If the A/V cables are connected to a VCR, pictures may be distorted due to the copy protection system.

## Connection to an Audio System

### Method 1

#### Stereo system

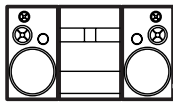

Analog audio input jacks

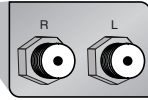

Audio cable (supplied)

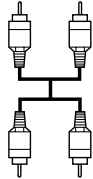

**AUDIO**

**DVD player**

(Analog)  
AUDIO OUT

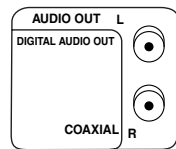

### Method 2

#### Dolby Digital decoder, MD deck or DAT deck



Digital audio input jack



Audio Coaxial Digital cable (commercially available)



**DIGITAL  
AUDIO OUT**

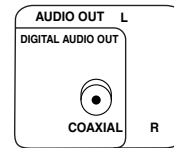

#### Note

- If output is Dolby Digital encoded audio, connect to a Dolby Digital decoder, and set "DOLBY DIGITAL" to "ON" in the AUDIO menu. (Refer to pages 14-15)
- The audio source on a disc in a Dolby Digital 5.1 channel surround format cannot be recorded as digital sound by an MD or DAT deck.
- Unless connected to a Dolby Digital decoder, set "DOLBY DIGITAL" to "OFF" in the AUDIO menu. Playing a DVD using incorrect settings may generate noise distortion, and may also damage the speakers. (Refer to pages 14-15)
- Set "DOLBY DIGITAL" to "OFF" in the AUDIO menu for connecting to an MD deck or DAT deck. (Refer to pages 14-15)
- By hooking this unit up to a Multi-channel Dolby Digital decoder, you can enjoy high-quality 5.1ch Dolby Digital surround sound as heard in the movie theaters.

## Rear Terminals

### AUDIO OUT jacks

Connect the supplied audio cables here through the audio in jacks of a television or other audio equipment.

### COMPONENT VIDEO OUT jacks

Connect optional component video cables here through the component video in jacks of a television.

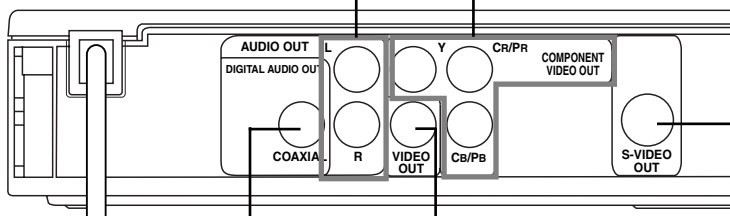

### S-VIDEO OUT jack

Connect an optional S-Video cable here through the S-video in jack of a television.

### COAXIAL jack

Connect an optional coaxial digital audio cable here through the coaxial digital audio in jack of a decoder or audio receiver.

### VIDEO OUT jack

Connect the supplied yellow video cable here through the TV's video in jack.

# About the Remote Control

## Remote Control

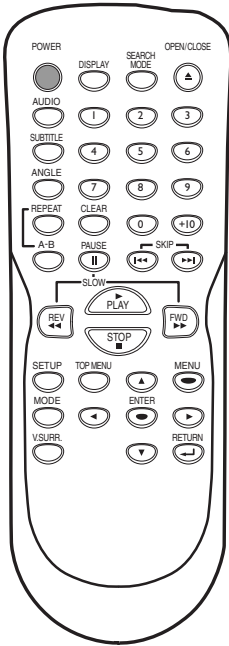

## Installing the Batteries for the Remote Control

Install two AA batteries (supplied) matching the polarity indicated inside battery compartment of the remote control.

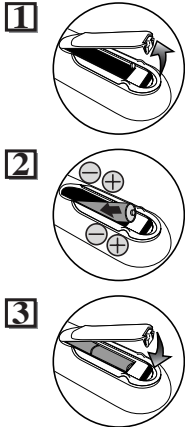

Keep in mind the following when using the remote control:

- Make sure that there is no obstacle between the remote and the remote sensor on the unit.
- Use within the operating range and angle, as shown.

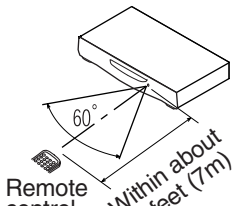

Button (Alphabetical order)	Disc	DVD-V	CD MP3
1 2 3 4 5 6 7 8 9 0		• To select chapter or title directly.	• To select track directly.
ENTER ← → ↑ ↓		• To move the cursor and determine its position.	• To move the cursor and determine its position.
A-B		• To repeat between your chosen point A and B.	• To repeat between your chosen point A and B.(CD)
ANGLE		• To select camera angles on a disc.	—
AUDIO		• To select audio languages on a disc.	• To select STEREO, L-CH or R-CH.(CD)
CLEAR		• To clear the markers. • To clear the numbers entered incorrectly.	• To clear the markers.(CD) • To remove status No. in program input. • To clear the numbers entered incorrectly.
DISPLAY		• To display the current disc mode.	• To display the current disc mode.
REV ← ← FWD → →		• To search forward/backward through a disc. • To begin slow forward /reverse playback during the pause mode.	• To search forward/backward through a disc.
MENU		• To call up the Menu on a disc.	• To call up the MP3 menu. (MP3)
MODE		• To set black level on/off.	• To arrange the playing order or play randomly.
OPEN/CLOSE ↑		• To open or close the disc tray.	• To open or close the disc tray.
PAUSE 		• To pause disc playback. • To advance playback one frame at a time.	• To pause disc playback.
PLAY ▶		• To begin disc playback.	• To begin disc playback.
POWER		• To turn the unit on or off.	• To turn the unit on or off.
REPEAT		• To play a chapter or title repeatedly.	• To play a track or disc repeatedly. (CD) • To play a track, group or disc repeatedly. (MP3)
RETURN ←		• To return to the previous operation in the DVD setup menu.	—
SEARCH MODE		• To search chapter, title or time. • To rapidly return to a location of disc. • Search the markers.	• To search track. • To search time. (CD) • To rapidly return to a location of disc. • Search the markers. (CD)
SETUP		• To call up the DVD setup menu.	• To call up the DVD setup menu.
SKIP ← →		• To skip chapters.	• To skip tracks.
STOP ■		• To stop playback.	• To stop playback.
SUBTITLE		• To select subtitles on a disc.	—
TOP MENU		• To call up the Top Menu on a disc.	• To return to the top file of the highest hierarchy in the program and MP3 menu. (MP3)
V.SURR.		• To set virtual surround on/off.	• To set virtual surround on/off.



# Functions

Operations described after this section are mainly based on the remote control use. Some operations can be carried out on main unit.

## Playback

Before: Turn on the TV, amplifier and any other components which are connected to the DVD player. Make sure the TV and audio receiver (commercially available) are set to the correct channel.

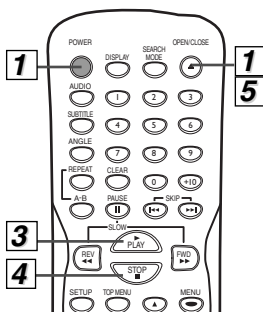
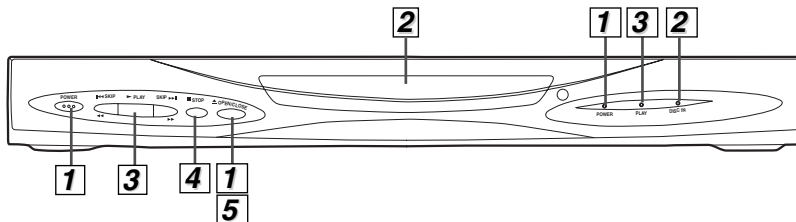
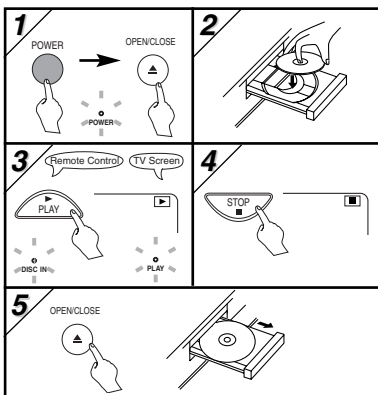

**Hint**

- When you play an MP3 file, details are on page 10.
- A "prohibited icon" may appear at the top-right on the TV screen when the operation is prohibited by the disc or this unit.
- Some DVDs may be played from title 2 or 3 due to specific programs.
- During the playback of a two-layered disc, pictures may stop for a moment. This happens while the 1st layer is being switched to the 2nd layer. This is not a malfunction.

### DVD menu

DVDs may contain menus to access special features. Press appropriate number buttons or use the arrow (▲/▼/◀/▶) buttons to highlight your selection in the DVD main menu and press the ENTER button to confirm.

### Calling up a Menu Screen during Playback

- Press the MENU button to call up the DVD menu.
- Press the TOP MENU button to call up the title menu.

**Note**

- Menu operations may vary depending on the disc. Refer to the manual accompanying the disc for details.

### Resume



Press the **STOP** button. Resume message will appear on the TV screen.

Press the **PLAY** button, playback will resume from the point at which playback was stopped.

- To cancel resume, press the **STOP** button one more time during the stop mode.
- For MP3, playback will resume from the beginning of the track at which playback was stopped.

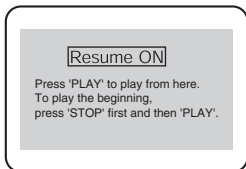

### Paused and Step-by-Step Playback



Press the **PAUSE** button during playback. **To continue playback, press the PLAY button.**



The disc goes forward by one frame each time the **PAUSE** button is pressed during the pause mode. **To continue playback, press the PLAY button.**

**Hint**

- Set "STILL MODE" to "FIELD" in the Display menu if pictures in the pause mode are blurred. (Refer to pages 14-15)

### Fast Forward/Reverse Search



Press the **▶▶** or **◀◀** button repeatedly during playback to select the required forward or reverse speed.

**To continue playback, press the PLAY button.**

- For DVDs, fast forward or reverse search speed is different depending on the disc. Approximate speed is 1(x2),2(x8),3(x50),4(x100).
- For Audio CDs, approximate speed is x16.
- For MP3, approximate speed is x8.

### Slow Forward/Slow Reverse



Press the **▶▶** or **◀◀** button repeatedly during the pause mode to select the required forward or reverse speed.

**To continue playback, press the PLAY button.**

- Slow forward or reverse speed is different depending on the disc. Approximate speed is 1(1/16),2(1/8),3(1/2).

**Hint**

- Set "STILL MODE" to "FIELD" in the Display menu if pictures in the slow playback mode are blurred. (Refer to pages 14-15)

# MP3 Playback

MP3 is a method of compressing files. You can copy MP3 files on CD-R/RWs from the computer and play the files on this unit.



Insert a MP3-format disc, then press the MENU button to call up the MP3 menu on the TV screen.

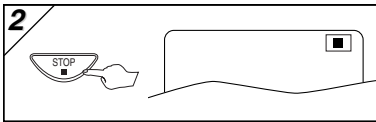
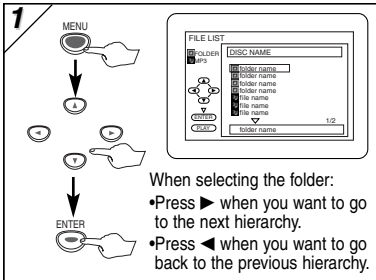

## Hint

- Some selections may take a while to be recognized.
- Press the TOP MENU button to return to the first item.
- Folders are known as Groups; files are known as Tracks.
- MP3 files are accompanied by icon.
- Folders are accompanied by icon.
- A maximum of 255 folders can be recognized.
- A maximum of 512 files can be recognized.
- Up to 8 hierarchies can be created.

This player recommends the files recorded under the following circumstances:

- Sampling frequency: 44.1kHz or 48kHz
- Constant bit rate: 112kbps ~ 320kbps.

## The On-Screen Display

You can check the information about the current disc by pressing the DISPLAY button on the remote control.

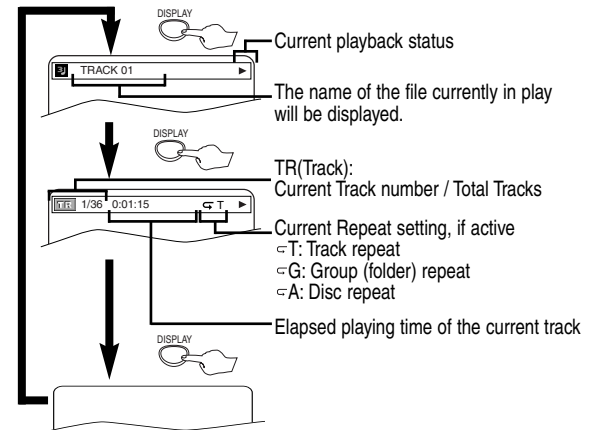
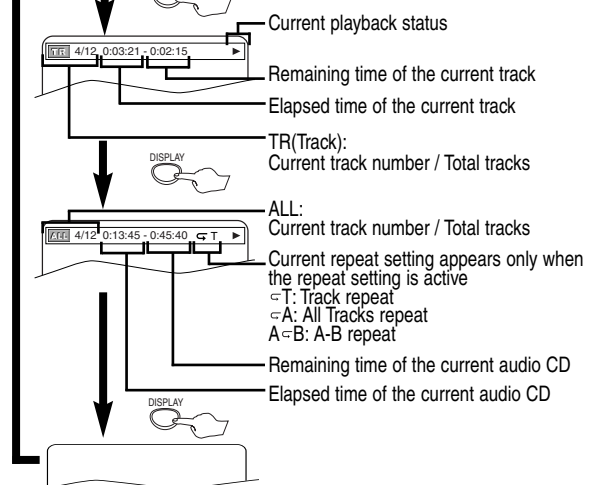
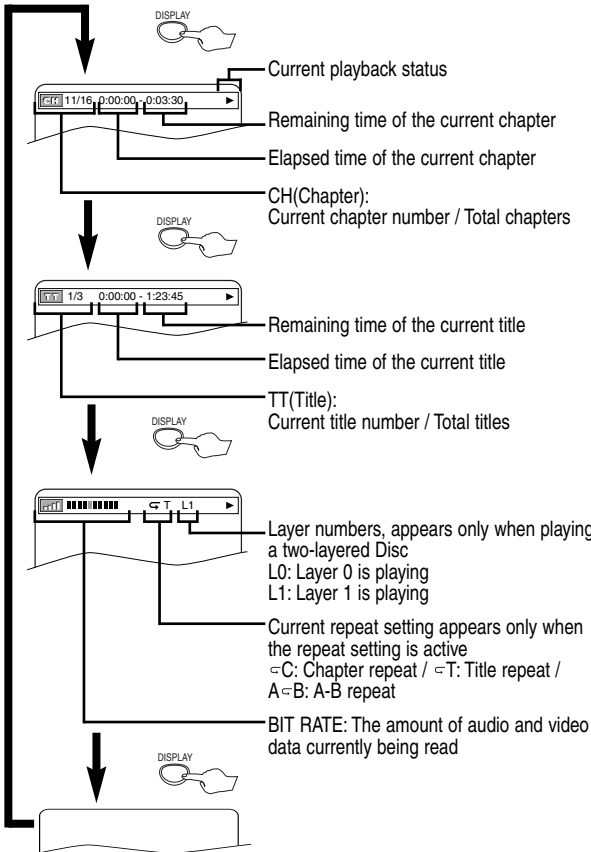

# Search Function

## Track Search



### Using the number buttons

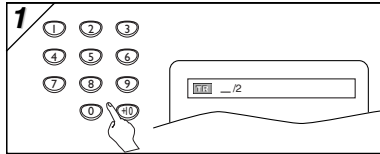

- For single digit tracks (1-9), press a single number (e.g. track 3, press 3).
- To play track 26, press +10, 2, 6 of the Number buttons.

### Using the SEARCH MODE button

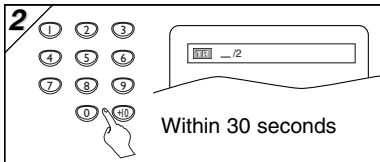
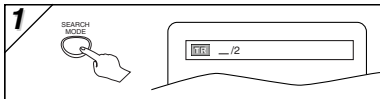

### Using the SKIP <<, >> button

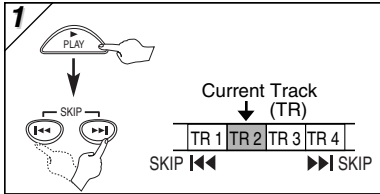

## Title / Chapter Search



### Using the SEARCH MODE button

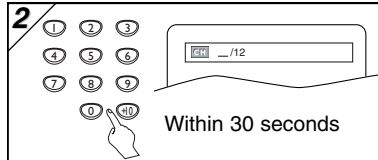
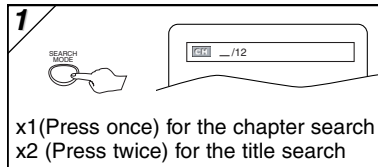

### Using the SKIP <<, >> button

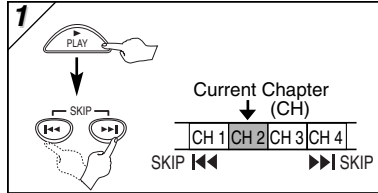

#### Note

- Depending on the disc being played, this function can also be performed by directly entering the desired chapter number with the number buttons. Refer to the manual accompanying the disc.

## Time Search

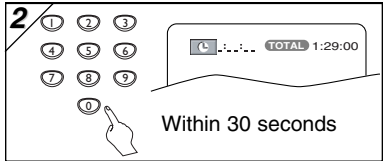
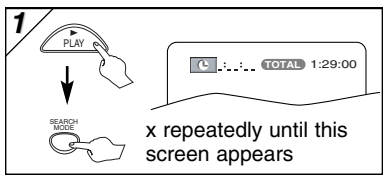

- If the former digits of the total time are "0", "0" is entered automatically. (e.g. if you enter 5:55, "0:0:..." will be displayed on the time search screen)

# Marker Setup



This feature allows you to assign a specific point on a disc to be called back later.

### To set a marker

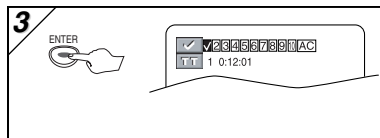
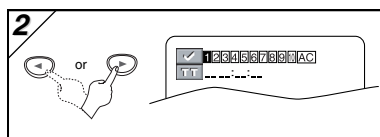
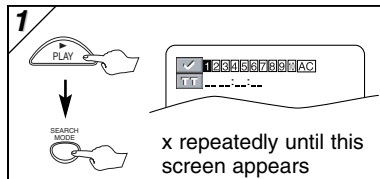

### To return to the marker later

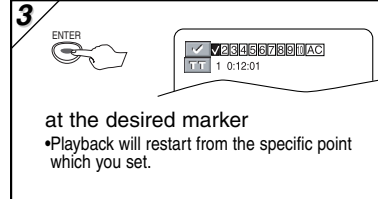
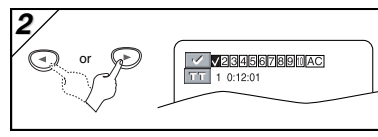
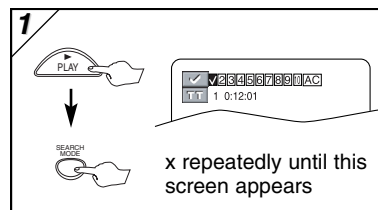

### To exit the marker screen

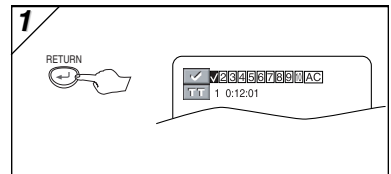

#### Notes

- Opening the disc tray or turning off the power will erase all markers.
- Selecting "AC" at step [2] in the section "To set a marker" will also erase all markers.
- To clear a marker, select the marker to be cleared at step [2] in the section "To return to the marker later," and then press the CLEAR button.

# Repeat / Random / Programmed Playback

## Repeat Playback



Repeat function is available only during playback.

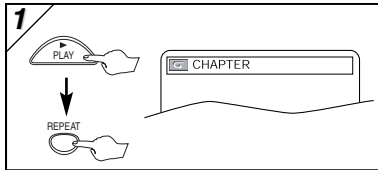

Each time the REPEAT button is pressed...

- DVD-V**
  - CHAPTER (current chapter repeat)
  - TITLE (current title repeat)
  - OFF (repeat off)
- CD**
  - TRACK (current track repeat)
  - ALL (entire disc repeat)
  - OFF (repeat off)
- MP3**
  - TRACK (current track repeat)
  - GROUP (current group repeat)
  - ALL (entire disc repeat)
  - OFF (repeat off)

- Repeat setting will be cleared when moving to another title, chapter, or track.
- Repeat playback are not available with all discs or during repeat A-B playback.

## Repeat A-B Playback

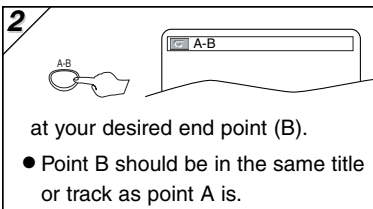
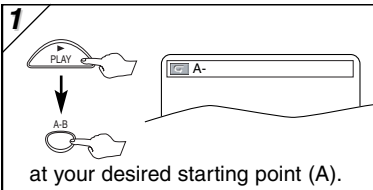

## Random Playback

This shuffles the playing order of tracks instead of playback in the sequence.

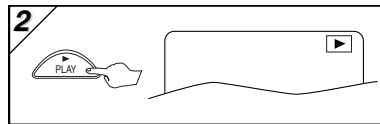
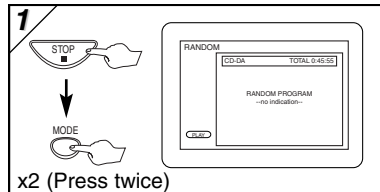

### Note

- If you want to repeat the current track in the random selections, press the REPEAT button repeatedly until  TRACK appears during playback. If you want to repeat the entire random selections, press the REPEAT button repeatedly until  ALL appears during playback.

## Programmed Playback



You may determine the order in which tracks will play.

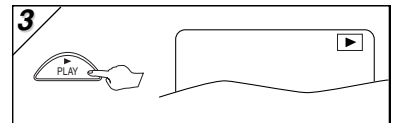
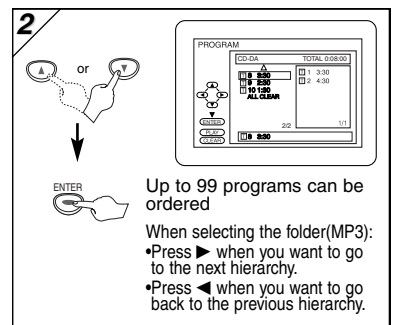
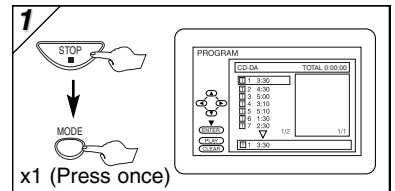

### Notes

- Press the CLEAR button at step [2] to erase the most recently entered program.
- To erase all programs at once, select "ALL CLEAR" and press the ENTER button at step [2].
- While a program is being played back, the STOP button works as follows;
  - ⇒ Press the STOP button and the PLAY button next, so that the programmed playback restarts. (CD playback restarts from the current point. MP3 playback restarts from the beginning of the current track.)
  - ⇒ Press the STOP button twice and the PLAY button next, so that playback restarts from the first track in the original order. However, your programmed playback can be restarted when you follow the above steps. (Your programs are still stored until either the disc tray is open or power is turned off.)
- To repeat the current track in the program, press the REPEAT button repeatedly until  TRACK appears during playback.
- To repeat the entire program press the REPEAT button repeatedly until  ALL appears during playback.

# Special Settings

## Subtitle Language



This unit allows you to select a subtitle language (if available) during DVD playback.

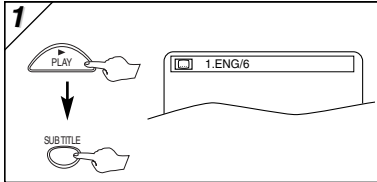

Each time you press the SUBTITLE button, subtitle languages change.

### For example

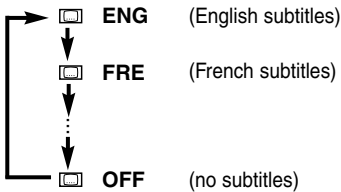

### To set subtitle ON/OFF

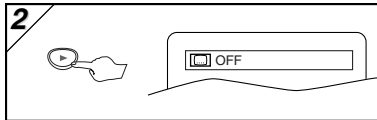
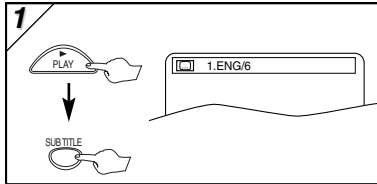

### Notes

- If your language is not shown after pressing the AUDIO or SUBTITLE button several times, the disc may not have that language. However, some discs allow you to change audio language or subtitle language setting in the disc menu. (Operation varies depending on the disc, so refer to the manual included in the disc.)
- If you choose a language that has three-letter-language code, the code will be displayed every time you change the subtitle language setting. If you choose any other languages, "..." will be displayed instead. (Refer to page 18)

## Audio Language



This unit allows you to select an audio language (if multiple languages are available) during DVD playback.

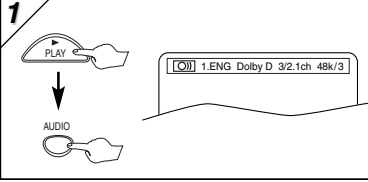

Each time you press the AUDIO button;

### For example

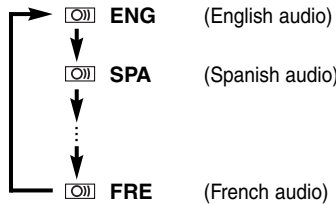

## Camera Angle



Some DVD discs may contain scenes which have been shot simultaneously from various angles. You can change the camera angle if the (ANGLE) icon appears on the screen. If the "ANGLE ICON" setting is "OFF" in the Display menu, the (ANGLE) icon will not appear. (Refer to pages 14-15)

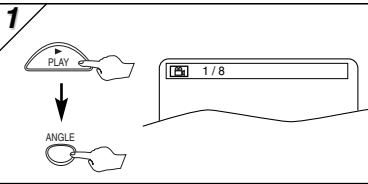

## Black Level Setting



Adjust the Black Level Setting to make the dark areas of the TV picture brighter.

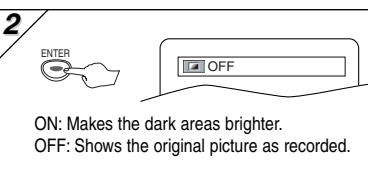
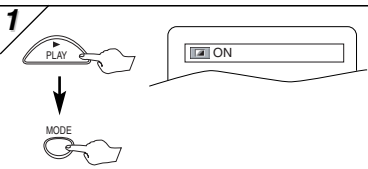

## Stereo Sound mode



This unit allows you to select a sound mode during CD playback.

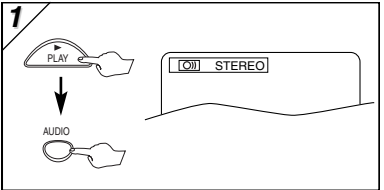

Each time you press the AUDIO button;

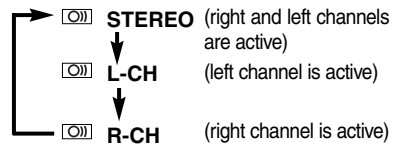

### Note

- If the Virtual Surround setting is "1" or "2", the sound mode will be fixed to STEREO, and can not be changed.

## Virtual Surround



You can enjoy stereophonic virtual world on your existing 2 channel stereo system.

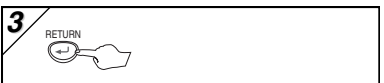
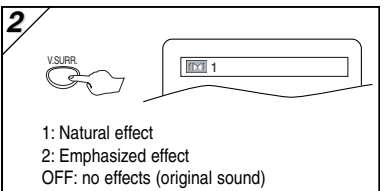
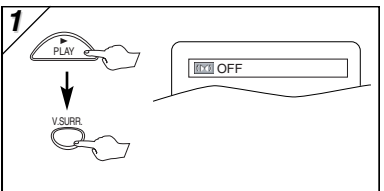

### Note (for CD play back only)

- Virtual Surround will not be effective if the sound mode is set to something other than STEREO.

# DVD Set Up

## QUICK SETUP Menu

You can select the "PLAYER MENU", "TV ASPECT" or "DOLBY DIGITAL" from the QUICK SETUP menu quickly.

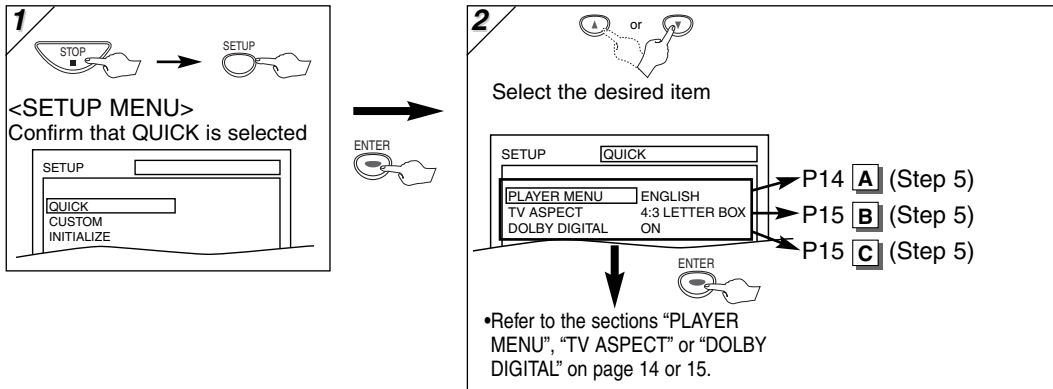

## CUSTOM Menu

You can change the DVD player's settings.

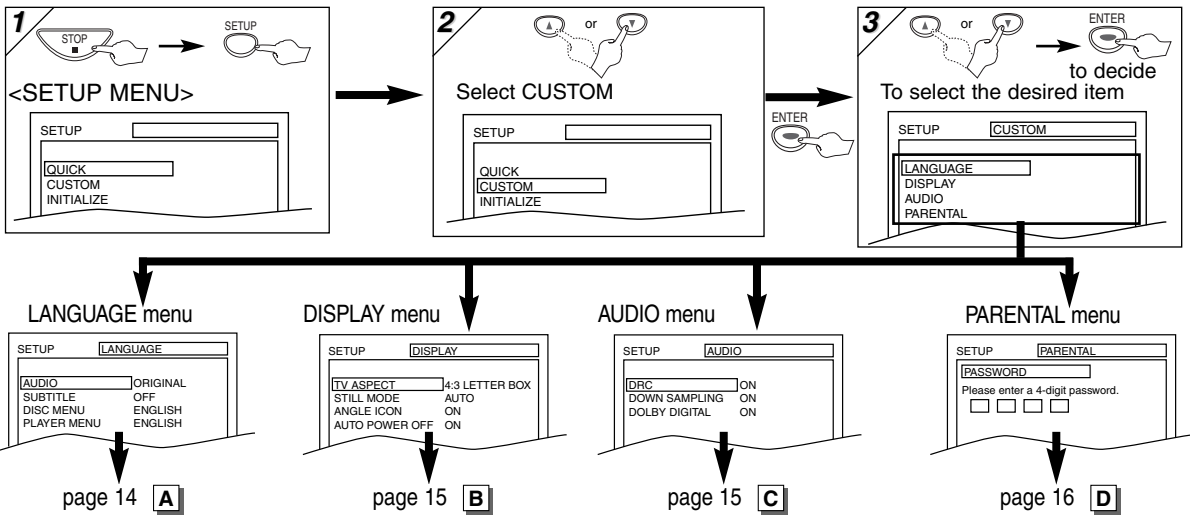

Functions

## A LANGUAGE Setting

Follow the steps 1) to 3) in the "CUSTOM Menu" section on page 14.

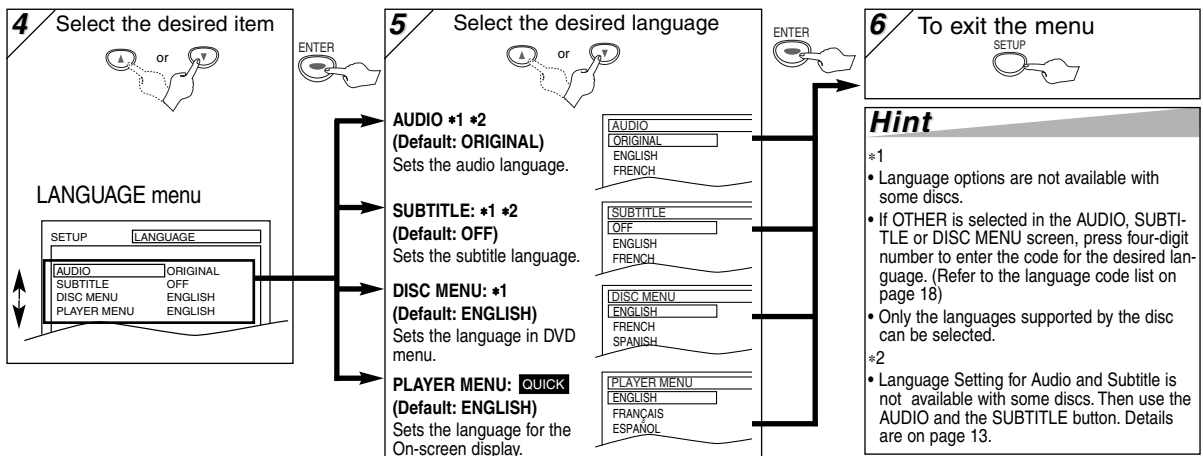

## B DISPLAY Setting

You can change the display functions. Follow the steps 1) to 3) in the "CUSTOM Menu" section on page 14.

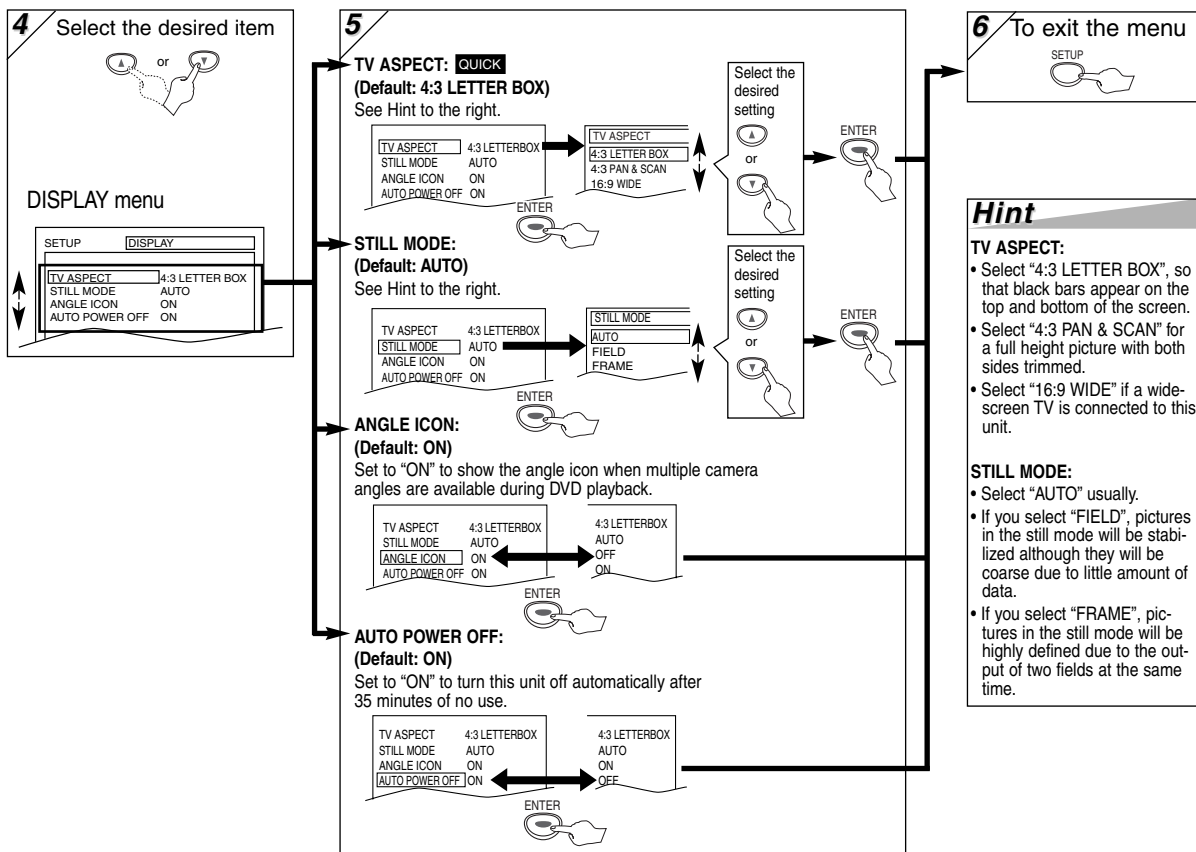

## C AUDIO Setting

Choose the appropriate audio settings for your equipment. It only affects during the playback of DVD discs. Follow the steps 1) to 3) in the "CUSTOM Menu" section on page 14.

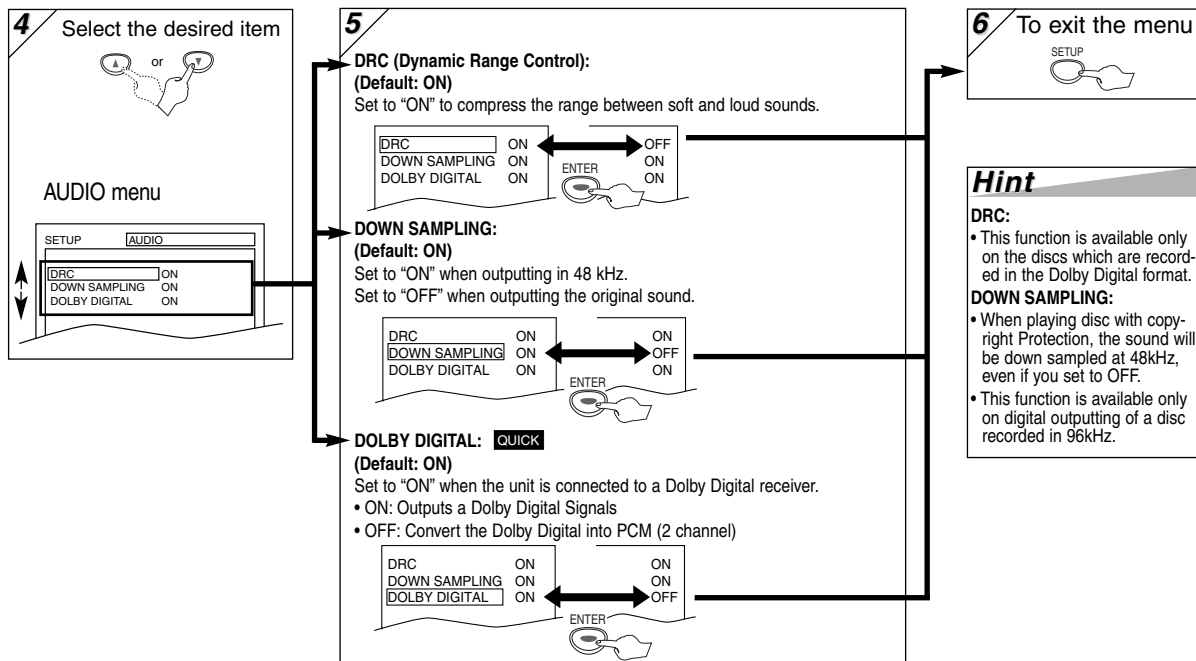

## D PARENTAL Setting

Parental Control limits the disc viewing that exceed your settings. (an incorrect password will not play.) This feature prevents your children from viewing inappropriate materials.

### Parental Levels

Parental Level allows you to set the rating levels of your DVD discs. Playback will stop if the ratings exceed the levels you set. Follow the steps 1) to 3) in the "CUSTOM Menu" section on page 14.

**4** Enter your desired four-digit password (except for 4737)

PARENTAL menu

or

If you have set a password already, enter the current four-digit password.

**5** Select "PARENTAL LEVEL"

**6** Select the desired levels

**7** To exit the menu

**Hint**

**CONTROL LEVELS**

- ALL: All parental locks are cancelled.
- Levels 8: DVD softwares of any grades (adult/general/children) can be played back.
- Levels 7 to 2: Only DVD softwares intended for general use and children can be played back.
- Level 1: Only DVD softwares intended for children can be played back, with those intended for adult and general use prohibited.

### To Change the Password for Parental Controls

You can change your password for parental controls. Follow the steps 1) to 3) in the "CUSTOM Menu" section on page 14.

**4** Enter your desired four-digit password (except for 4737)

PARENTAL menu

**5** Select "CHANGE"

**6** Enter your new four-digit password (except for 4737)

**7** To exit the menu

**Hint**

- Record the password in case you forget it.
- If you forget the password, press 4, 7, 3, 7 at step 4, then enter your new password.
- Password will be cleared and parental levels will be set to ALL.

### To return the All Selections of SET UP (except for PARENTAL) to the Default Setting

**1**

<SETUP MENU>

**2**

Select INITIALIZE

**3**

Select "YES"

**4** To exit the menu

x2 (twice)

**Hint**

- When you cancel to initialize at step 3, select "NO".



## Troubleshooting Guide

If the DVD player does not perform properly when operated as instructed in this Operating Instruction, check the player, consulting the following checklist.

<b>Problem</b>	<b>Solution</b>
<b>No power</b>	<ul style="list-style-type: none"> <li>-Check if the AC power cord is properly connected.</li> <li>-Unplug the outlet once, and wait for 5-10seconds and then plug it in again</li> </ul>
<b>No sound or picture</b>	<ul style="list-style-type: none"> <li>-Check if the TV is switched on.</li> <li>-Check the video connection</li> <li>-Check the VIDEO/AUDIO cable connections to the TV (See Connection to a TV)</li> </ul>
<b>Distorted picture</b>	<ul style="list-style-type: none"> <li>-Sometimes a small amount of picture distortion may appear. This is not a malfunction.</li> <li>-Connect the player directly to the TV.</li> </ul>
<b>Completely distorted picture or black/white picture with DVD</b>	<ul style="list-style-type: none"> <li>-Connect DVD player directly to the TV.</li> <li>-Make sure the disc is compatible with the DVD player.</li> </ul>
<b>No sound or distorted sound</b>	<ul style="list-style-type: none"> <li>-Adjust the volume.</li> <li>-Check that the speakers are connected correctly.</li> </ul>
<b>No audio at digital output</b>	<ul style="list-style-type: none"> <li>-Check the digital connections.</li> <li>-Check if the audio format of the selected audio language matches your receiver capabilities.</li> </ul>
<b>No DTS audio is output</b>	<ul style="list-style-type: none"> <li>-This player does not support DTS audio. This is not a malfunction.</li> </ul>
<b>Picture freezes momentarily during playback</b>	<ul style="list-style-type: none"> <li>-Check the disc for fingerprints/scratches and clean with a soft cloth wiping from center to edge.</li> <li>-Clean the disc</li> </ul>
<b>Disc can't be played</b>	<ul style="list-style-type: none"> <li>-Clean the disc</li> <li>-Ensure the disc label is facing up.</li> <li>-Check if the disc is defective by trying another disc.</li> <li>-Cancel the parental lock or change the control level.</li> <li>-Insert a correct disc that plays on this player.</li> <li>-Handle a disc with special care so that it does not have fingerprints, scratches, or dusts on its surface.</li> </ul>
<b>No return to start-up screen when disc is removed</b>	<ul style="list-style-type: none"> <li>-Reset the player by switching the player off, then on again.</li> </ul>
<b>The player does not respond to the remote control</b>	<ul style="list-style-type: none"> <li>-Aim the remote control directly at the sensor on the front of the player.</li> <li>-Reduce the distance to the player.</li> <li>-Replace the batteries in the remote control.</li> <li>-Re-insert the batteries with their polarities (+/- signs) as indicated.</li> <li>-Tune your radio to an empty AM station so that you hear a lot of noises. Turn the volume up, then. If you hear some signal sound from the radio in response to your pressing buttons on the remote, the remote control is working.</li> </ul>
<b>Buttons do not work or player stops responding</b>	<ul style="list-style-type: none"> <li>-To completely reset the player, unplug the AC cord from the AC outlet for 5-10 seconds.</li> </ul>
<b>Player does not respond to some operating commands during playback</b>	<ul style="list-style-type: none"> <li>-Operations may not be permitted by the disc. Refer to the instructions of the disc.</li> </ul>
<b>DVD player cannot read CDs/DVDs</b>	<ul style="list-style-type: none"> <li>-Use a commonly available cleaning CD/DVD to clean the lens before sending the DVD player for repair.</li> </ul>
<b>Angle does not switch</b>	<ul style="list-style-type: none"> <li>-The angle cannot be switched for DVDs which do not contain multiple angles. In some cases multiple angles are only recorded for specific scenes.</li> </ul>
<b>Playback does not start when the title is selected</b>	<ul style="list-style-type: none"> <li>-Check the "PARENTAL" setting.</li> </ul>
<b>The password for rating level has been forgotten</b>	<ul style="list-style-type: none"> <li>-Enter the default password "4737", then your forgotten password will be cleared</li> </ul>
<b>The PLAY indicator on the front panel flashes</b>	<ul style="list-style-type: none"> <li>-An unacceptable disc is installed. Insert a playable disc.</li> </ul>

### NOTES:

- Some functions are not available in specific modes, but this is not a malfunction. Read the description in this Operating Instruction for details on correct operations.
- Playback from a desired track and random playback are not available during program playback.
- Some functions are prohibited on some discs.

# Specifications

## Output signal format:

NTSC color

## Power source:

120 V AC +/- 10%, 60 Hz +/- 0.5%

## Power consumption:

10 W (standby: 0.8 W)

## Operating temperature:

41°F (5°C) to 104°F (40°C)

## Dimensions:

W : 17 1/8" (435 mm)

H : 1 15/16" (50 mm)

D : 8 5/16" (211 mm)

## Weight:

Approx. 2.9 lbs (1.3 kg)

• Designs and specifications are subject to change without notice.

• If there is a discrepancy between languages, the default language will be English.

# Language List

Language	Code	Language	Code	Language	Code	Language	Code
Abkhazian	A-B	French [FRE]	5264	Macedonian	5957	Siswat	6565
Afar		Frisian	5271	Malagasy	5953	Slovak	6557
Afrikaans		Galician	5358	Malay	5965	Slovenian	6558
Albanian		Georgian	5747	Malayalam	5958	Somali	6561
Amharic		German [GER]	5051	Maltese	5966	Spanish [SPA]	5165
Arabic		Greek [GRE]	5158	Maori	5955	Sundanese	6567
Armenian		Greenlandic	5758	Marathi	5964	Swahili	6569
Assamese		Guarani	5360	Moldavian	5961	Swedish [SWE]	6568
Aymara		Gujarati	5367	Mongolian	5960		
Azerbaijani		Hausa	5447	Nauru	6047	Tagalog	6658
Bashkir		Hebrew	5569	Nepali	6051	Tajik	6653
Basque		Hindi	5455	Norwegian [NOR]	6061	Tamil	6647
Bengali; Bangla		Hungarian [HUN]	5467			Tatar	6666
Bhutani				O-R		Telugu	6651
Bihari		Icelandic [ICE]	5565	Occitan	6149	Thai	6654
Bislama		Indonesian	5560	Oriya	6164	Tibetan	4861
Breton		Interlingua	5547	Oromo (Afan)	6159	Tigrinya	6655
Bulgarian		Interlingue	5551	Pashto; Pushto	6265	Tonga	6661
Burmese		Inupiak	5557	Persian	5247	Tsonga	6665
Byelorussian		Irish [IRI]	5347	Polish	6258	Turkish [TUR]	6664
		Italian [ITA]	5566	Portuguese [POR]	6266	Turkmen	6657
		Japanese [JPN]	5647	Quechua	6367	Twi	6669
Cambodian	C-E	Javanese	5669	Rhaeto-Romance	6459		
Catalan		Kannada	5760	Romanian [RUM]	6461	Ukrainian	6757
Chinese [CHI]		Kashmiri	5765	Russian [RUS]	6467	Urdu	6764
Corsican		Kazakh	5757			Uzbek	6772
Croatian		Kinyarwanda	6469	Samoan	6559	Vietnamese	6855
Czech		Kirghiz	5771	Sangho	6553	Volapuk	6861
Danish [DAN]		Kirundi	6460	Sanskrit	6547	Welsh	4971
Dutch [DUT]		Korean [KOR]	5761	Scots Gaelic	5350	Wolof	6961
English [ENG]		Kurdish	5767	Serbian	6564	Xhosa	7054
Esperanto				Serbo-Croatian	6554	Yiddish	5655
Estonian		Laothian	L-N	Sesotho	6566	Yoruba	7161
		Latin		Setswana	6660	Zulu	7267
Faroese	F-H	Latvian; Lettish	5847	Shona	6560		
Fiji		Lingala	5868	Sindhi	6550		
Finnish [FIN]		Lithuanian	5866	Singhalese	6555		

If you choose a Language that has a 3 letter language code, the code will be displayed every time you change the Audio or Subtitle language setting on page 13. If you choose any other languages, '-' will be displayed instead. (3 letter language code is written in bracket.)

## Emerson Limited Warranty

FUNAI CORP. will repair this Emerson product, free of charge in the USA in the event of defect in materials or workmanship as follows:

### DURATION:

**PARTS:** FUNAI CORP. will provide parts to replace defective parts without charge for one (1) year from the date of original retail purchase. Two (2) years for Picture Tube. Certain parts are excluded from this warranty.

**LABOR:** FUNAI CORP. will provide the labor without charge for a period of ninety (90) days from the date of original retail purchase.

### LIMITS AND EXCLUSIONS:

THIS WARRANTY IS EXTENDED ONLY TO THE ORIGINAL RETAIL PURCHASER. A PURCHASE RECEIPT OR OTHER PROOF OF ORIGINAL RETAIL PURCHASE WILL BE REQUIRED TOGETHER WITH THE PRODUCT TO OBTAIN SERVICE UNDER THIS WARRANTY.

This warranty shall not be extended to any other person or transferee.

This warranty is void and of no effect if any serial numbers on the product are altered, replaced, defaced, missing or if service was attempted by an unauthorized service center. This Emerson Limited warranty does not apply to any product not purchased and used in the United States.

This warranty only covers failures due to defects in material or workmanship which occurs during normal use. It does not cover damage which occurs in shipment, or failures which are caused by repairs, alterations or product not supplied by FUNAI CORP., or damage which results from accident, misuse, abuse, mishandling, misapplication, alteration, faulty installation, improper maintenance, commercial use such as hotel, rental or office use of this product or damage which results from fire, flood, lightning or other acts of God.

THIS WARRANTY DOES NOT COVER PACKING MATERIALS, ANY ACCESSORIES (EXCEPT REMOTE CONTROL), ANY COSMETIC PARTS, COMPLETE ASSEMBLY PARTS, DEMO OR FLOOR MODELS.

FUNAI CORP. AND ITS REPRESENTATIVES OR AGENTS SHALL IN NO

EVENT BE LIABLE FOR ANY GENERAL, INDIRECT OR CONSEQUENTIAL DAMAGES ARISING OUT OF OR OCCASIONED BY THE USE OF OR THE INABILITY TO USE THIS PRODUCT. THIS WARRANTY IS MADE IN LIEU OF ALL OTHER WARRANTIES, EXPRESS OR IMPLIED, AND OF ALL OTHER LIABILITIES ON THE PART OF FUNAI, ALL OTHER WARRANTIES INCLUDING THE WARRANTY OF MERCHANTABILITY, AND FITNESS FOR A PARTICULAR PURPOSE, ARE HEREBY DISCLAIMED BY FUNAI AND ITS REPRESENTATIVES IN THE UNITED STATES.

ALL WARRANTY INSPECTIONS AND REPAIRS MUST BE PERFORMED BY A FUNAI AUTHORIZED SERVICE CENTER. THIS WARRANTY IS VALID WHEN THE UNIT IS CARRIED-IN TO FUNAI AUTHORIZED SERVICE FACILITY.

### IMPORTANT:

THIS LIMITED WARRANTY GIVES YOU SPECIFIC LEGAL RIGHTS, YOU MAY HAVE OTHER RIGHTS THAT VARY FROM STATE TO STATE, IF, AT ANY TIME DURING THE WARRANTY PERIOD, YOU ARE UNABLE TO OBTAIN SATISFACTION WITH THE REPAIR OF THIS PRODUCT, PLEASE CONTACT FUNAI CORP.

### ATTENTION:

FUNAI CORP. RESERVES THE RIGHT TO MODIFY ANY DESIGN OF THIS PRODUCT WITHOUT PRIOR NOTICE.

To locate your nearest Emerson Authorized Service Center or for general service procedure, please call 1-800-256-2487 or write to the following:

**FUNAI CORPORATION, INC.  
SERVICE CENTER**

19900 Van Ness Avenue, Torrance, CA 90501

Tel : 1-800-256-2487

<http://www.funai-corp.com>

Head Office: 100 North Street, Teterboro, NJ 07608

PLEASE DO NOT SHIP YOUR UNIT TO THE TETERBORO ADDRESS.

## 1 Conexiones

Si su televisor tiene tomas de entrada AUDIO/VIDEO vea la sección "Conexiones" en las páginas 6-7. En caso contrario, vea la sección "Antes de utilizar su reproductor de DVD" en la página del frente.

## 2 Instalación de las pilas en el mando a distancia



## 3 Para cambiar el idioma en la pantalla

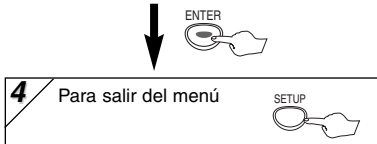
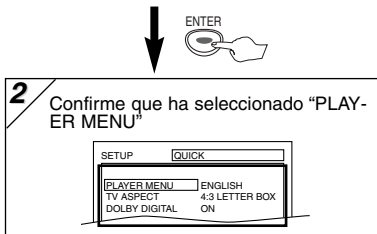
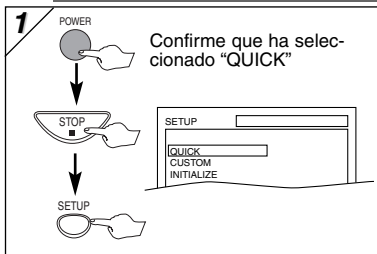

## 4 Reproducción

Antes.

• Encienda el televisor, amplificador y otros equipos conectados a esta unidad. Asegúrese que el televisor y el sintonizador de audio (de venta en los comercios) están en el canal correcto.

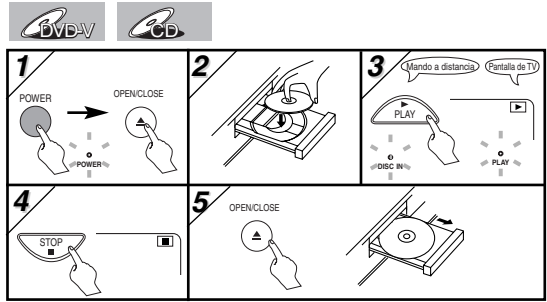
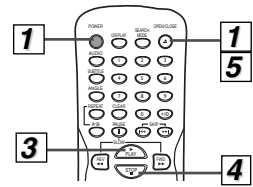

## 5 Mando a distancia

Botón (Orden alfabético)	Disco	DVD	CD MP3
1 2 3 4 5 6 7 8 9 0		• Para seleccionar directamente el capítulo o título.	• Para seleccionar directamente la canción.
ENTER		• Para mover el cursor y determinar la posición.	• Para mover el cursor y determinar la posición.
A-B		• Para repetir entre su punto A y B seleccionado.	• Para repetir entre su punto A y B seleccionado. (Disco compacto)
ANGLE		• Para seleccionar los ángulos de cámara en un disco.	—
AUDIO		• Para seleccionar idiomas de audio en un disco.	• Para seleccionar ESTÉREO L-CH o R-CH. (Disco compacto)
CLEAR		• Para borrar los marcadores. • Para borrar los números mal entrados.	• Para borrar los marcadores. (Disco compacto) • Para eliminar el N° de estado en la entrada de programa. • Para borrar los números mal entrados.
DISPLAY		• Para mostrar el modo de disco actual.	• Para mostrar el modo de disco actual.
REV FWD		• Para buscar en avance/retroceso por un disco. • Para empezar la reproducción en avance lento/retroceso durante el modo de pausa.	• Para buscar en avance/retroceso por un disco.
MENU		• Para llamar el Menú en un disco.	• Para llamar el menú MP3. (MP3)
MODE		• Para activar/desactivar el nivel del negro.	• Para disponer el orden de reproducción o la reproducción aleatoria.
OPEN/CLOSE		• Para abrir o cerrar la bandeja del disco.	• Para abrir o cerrar la bandeja del disco.
PAUSE		• Para hacer una pausa en la reproducción. • Para avanzar la reproducción un cuadro cada vez.	• Para hacer una pausa en la reproducción del disco.
PLAY		• Para empezar la reproducción del disco.	• Para empezar la reproducción del disco.
POWER		• Para activar o desactivar la unidad.	• Para activar o desactivar la unidad.
REPEAT		• Para reproducir repetidamente un capítulo o título.	• Para reproducir repetidamente una canción, grupo o disco. (MP3)
RETURN		• Para volver a la operación anterior en el menú de ajustes de DVD.	—
SEARCH MODE		• Para buscar un capítulo, título o tiempo. • Para volver rápidamente a un lugar del disco. • Busque los marcadores.	• Para buscar una canción. • Para buscar el tiempo. (Disco compacto) • Para volver aleatoriamente a un lugar del disco. • Busque los marcadores. (Disco compacto)
SETUP		• Para llamar el menú de ajustes de DVD.	• Para llamar el menú de ajustes de DVD.
SKIP		• Para saltar capítulos.	• Para saltar canciones.
STOP		• Para parar la reproducción.	• Para parar la reproducción.
SUBTITLE		• Para seleccionar subtítulos en un disco.	—
TOP MENU		• Para llamar el menú inicial en un disco.	• Para volver al archivo inicial en la jerarquía más alta en el programa y el menú MP3. (MP3)
V.SURR.		• Para activar/desactivar el ambiental virtual.	• Para activar/desactivar el ambiental virtual.

# Quick Use Guide

## 1 Connections

If your TV has AUDIO/VIDEO input jacks, see the section "Connections" on pages 6-7. If not, see the section "Before using your DVD player" on the front page.

## 2 Installing the Batteries for the Remote Control



## 3 To Change the On-Screen Language

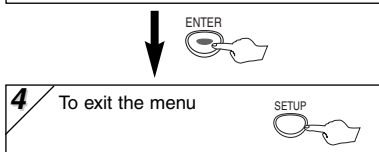
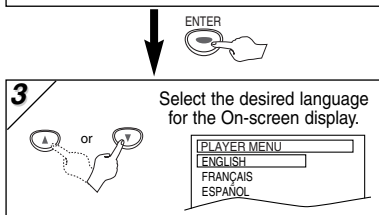
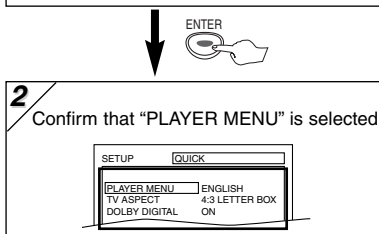
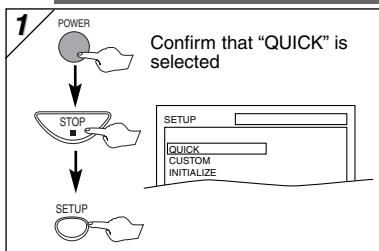

## 4 Playback

Before:

- Turn on the TV, amplifier and any other components which are connected to this unit. Make sure the TV and audio receiver (commercially available) are set to the correct channel.

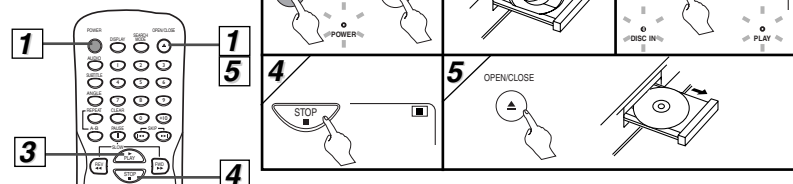

## 5 Remote Control

Button (Alphabetical order)	DVD	CD MP3
1 2 3 4 5 6 7 8 9 0	• To select chapter or title directly.	• To select track directly.
ENTER	• To move the cursor and determine its position.	• To move the cursor and determine its position.
A-B	• To repeat between your chosen point A and B.	• To repeat between your chosen point A and B.(CD)
ANGLE	• To select camera angles on a disc.	—
AUDIO	• To select audio languages on a disc.	• To select STEREO, L-CH or R-CH.(CD)
CLEAR	• To clear the markers. • To clear the numbers entered incorrectly.	• To clear the markers.(CD) • To remove status No. in program input. • To clear the numbers entered incorrectly.
DISPLAY	• To display the current disc mode.	• To display the current disc mode.
REV FWD	• To search forward/backward through a disc. • To begin slow forward /reverse playback during the pause mode.	• To search forward/backward through a disc.
MENU	• To call up the Menu on a disc.	• To call up the MP3 menu. (MP3)
MODE	• To set black level on/off.	• To arrange the playing order or play randomly.
OPEN/CLOSE	• To open or close the disc tray.	• To open or close the disc tray.
PAUSE	• To pause disc playback. • To advance playback one frame at a time.	• To pause disc playback.
PLAY	• To begin disc playback.	• To begin disc playback.
POWER	• To turn the unit on or off.	• To turn the unit on or off.
REPEAT	• To play a chapter or title repeatedly.	• To play a track or disc repeatedly. (CD) • To play a track, group or disc repeatedly. (MP3)
RETURN	• To return to the previous operation in the DVD setup menu.	—
SEARCH MODE	• To search chapter, title or time. • To rapidly return to a location of disc. • Search the markers.	• To search track. • To search time. (CD) • To rapidly return to a location of disc. • Search the markers. (CD)
SETUP	• To call up the DVD setup menu.	• To call up the DVD setup menu.
SKIP	• To skip chapters.	• To skip tracks.
STOP	• To stop playback.	• To stop playback.
SUBTITLE	• To select subtitles on a disc.	—
TOP MENU	• To call up the Top Menu on a disc.	• To return to the top file of the highest hierarchy in the program and MP3 menu. (MP3)
V.SURR.	• To set virtual surround on/off.	• To set virtual surround on/off.

