

# MUSIC ATELIER

## AT5

### Owner's Manual

Before using this unit, carefully read the sections entitled: "IMPORTANT SAFETY INSTRUCTIONS" (p. 2), "USING THE UNIT SAFELY" (p. 3, 4), and "IMPORTANT NOTES" (p. 5, 6). These sections provide important information concerning the proper operation of the unit. Additionally, in order to feel assured that you have gained a good grasp of every feature provided by your new unit, Owner's manual should be read in its entirety. The manual should be saved and kept on hand as a convenient reference.

Copyright © 2003 ROLAND CORPORATION

All rights reserved. No part of this publication may be reproduced in any form without the written permission of ROLAND CORPORATION.

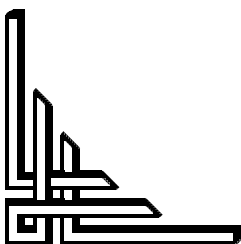

Roland®

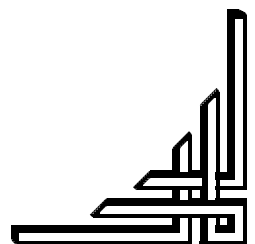











# USING THE UNIT SAFELY

## INSTRUCTIONS FOR THE PREVENTION OF FIRE, ELECTRIC SHOCK, OR INJURY TO PERSONS

### About WARNING and CAUTION Notices







 <b>WARNING</b>	Used for instructions intended to alert the user to the risk of death or severe injury should the unit be used improperly.
 <b>CAUTION</b>	Used for instructions intended to alert the user to the risk of injury or material damage should the unit be used improperly. * Material damage refers to damage or other adverse effects caused with respect to the home and all its furnishings, as well to domestic animals or pets.

### About the Symbols





	The  symbol alerts the user to important instructions or warnings. The specific meaning of the symbol is determined by the design contained within the triangle. In the case of the symbol at left, it is used for general cautions, warnings, or alerts to danger.
	The  symbol alerts the user to items that must never be carried out (are forbidden). The specific thing that must not be done is indicated by the design contained within the circle. In the case of the symbol at left, it means that the unit must never be disassembled.
	The  symbol alerts the user to things that must be carried out. The specific thing that must be done is indicated by the design contained within the circle. In the case of the symbol at left, it means that the power-cord plug must be unplugged from the outlet.

### ALWAYS OBSERVE THE FOLLOWING

#### **WARNING**

- Before using this unit, make sure to read the instructions below, and the Owner's Manual. 
- Do not open (or modify in any way) the unit or its AC adaptor. 
- Do not attempt to repair the unit, or replace parts within it (except when this manual provides specific instructions directing you to do so). Refer all servicing to your retailer, the nearest Roland Service Center, or an authorized Roland distributor, as listed on the "Information" page. 
- Never use or store the unit in places that are:
  - Subject to temperature extremes (e.g., direct sunlight in an enclosed vehicle, near a heating duct, on top of heat-generating equipment); or are 
  - Damp (e.g., baths, washrooms, on wet floors); or are 
  - Humid; or are
  - Exposed to rain; or are
  - Dusty; or are
  - Subject to high levels of vibration.
- Make sure you always have the unit placed so it is level and sure to remain stable. Never place it on stands that could wobble, or on inclined surfaces. 
- Be sure to use only the AC adaptor supplied with the unit. Also, make sure the line voltage at the installation matches the input voltage specified on the AC adaptor's body. Other AC adaptors may use a different polarity, or be designed for a different voltage, so their use could result in damage, malfunction, or electric shock. 

#### **WARNING**

- Use only the attached power-supply cord. 
- Do not excessively twist or bend the power cord, nor place heavy objects on it. Doing so can damage the cord, producing severed elements and short circuits. Damaged cords are fire and shock hazards! 
- This unit, either alone or in combination with an amplifier and headphones or speakers, may be capable of producing sound levels that could cause permanent hearing loss. Do not operate for a long period of time at a high volume level, or at a level that is uncomfortable. If you experience any hearing loss or ringing in the ears, you should immediately stop using the unit, and consult an audiologist. 
- Do not allow any objects (e.g., flammable material, coins, pins); or liquids of any kind (water, soft drinks, etc.) to penetrate the unit. 

## USING THE UNIT SAFELY

### WARNING

- Immediately turn the power off, remove the AC adaptor from the outlet, and request servicing by your retailer, the nearest Roland Service Center, or an authorized Roland distributor, as listed on the “Information” page when:



- The AC adaptor, the power-supply cord, or the plug has been damaged; or
- If smoke or unusual odor occurs
- Objects have fallen into, or liquid has been spilled onto the unit; or
- The unit has been exposed to rain (or otherwise has become wet); or
- The unit does not appear to operate normally or exhibits a marked change in performance.

- In households with small children, an adult should provide supervision until the child is capable of following all the rules essential for the safe operation of the unit.



- Protect the unit from strong impact. (Do not drop it!)



- Do not force the unit’s power-supply cord to share an outlet with an unreasonable number of other devices. Be especially careful when using extension cords—the total power used by all devices you have connected to the extension cord’s outlet must never exceed the power rating (watts/amperes) for the extension cord. Excessive loads can cause the insulation on the cord to heat up and eventually melt through.



- Before using the unit in a foreign country, consult with your retailer, the nearest Roland Service Center, or an authorized Roland distributor, as listed on the “Information” page.



### CAUTION

- The unit and the AC adaptor should be located so their location or position does not interfere with their proper ventilation.



- Always grasp only the plug on the AC adaptor cord when plugging into, or unplugging from, an outlet or this unit.



### CAUTION

- At regular intervals, you should unplug the AC adaptor and clean it by using a dry cloth to wipe all dust and other accumulations away from its prongs. Also, disconnect the power plug from the power outlet whenever the unit is to remain unused for an extended period of time. Any accumulation of dust between the power plug and the power outlet can result in poor insulation and lead to fire.



- Try to prevent cords and cables from becoming entangled. Also, all cords and cables should be placed so they are out of the reach of children.



- Never climb on top of, nor place heavy objects on the unit.



- Never handle the AC adaptor or its plugs with wet hands when plugging into, or unplugging from, an outlet or this unit.



- If you need to move the instrument, take note of the precautions listed below. At least two persons are required to safely lift and move the unit. It should be handled carefully, all the while keeping it level. Make sure to have a firm grip, to protect yourself from injury and the instrument from damage.



- Check to make sure the screws securing the unit to the stand have not become loose. Fasten them again securely whenever you notice any loosening.
- Disconnect the power cord.
- Disconnect all cords coming from external devices.
- Raise the adjusters on the stand.
- Remove the music stand.

- Before cleaning the unit, turn off the power and unplug the AC adaptor from the outlet (p. 14).



- Whenever you suspect the possibility of lightning in your area, disconnect the AC adaptor from the outlet.



- When using the bench, please observe the following points:



- Do not use the bench as a toy, or as a stepping stool.
- Do not allow two or more persons to sit on the bench.

- Should you remove screws and caps, make sure to put them in a safe place out of children’s reach, so there is no chance of them being swallowed accidentally.



# Important Notes

In addition to the items listed under “USING THE UNIT SAFELY” on page 3 and 4, please read and observe the following:

## Power Supply

- Do not use this unit on the same power circuit with any device that will generate line noise (such as an electric motor or variable lighting system).
- The AC adaptor will begin to generate heat after long hours of consecutive use. This is normal, and is not a cause for concern.
- Before connecting this unit to other devices, turn off the power to all units. This will help prevent malfunctions and/or damage to speakers or other devices.

## Placement

- Using the unit near power amplifiers (or other equipment containing large power transformers) may induce hum. To alleviate the problem, change the orientation of this unit; or move it farther away from the source of interference.
- This device may interfere with radio and television reception. Do not use this device in the vicinity of such receivers.
- Noise may be produced if wireless communications devices, such as cell phones, are operated in the vicinity of this unit. Such noise could occur when receiving or initiating a call, or while conversing. Should you experience such problems, you should relocate such wireless devices so they are at a greater distance from this unit, or switch them off.
- Observe the following when using the unit’s floppy disk drive. For further details, refer to “Before Using Floppy Disks” (p. 6).
  - Do not place the unit near devices that produce a strong magnetic field (e.g., loudspeakers).
  - Install the unit on a solid, level surface.
  - Do not move the unit or subject it to vibration while the drive is operating.
- Do not expose the unit to direct sunlight, place it near devices that radiate heat, leave it inside an enclosed vehicle, or otherwise subject it to temperature extremes. Also, do not allow lighting devices that normally are used while their light source is very close to the unit (such as a piano light), or powerful spotlights to shine upon the same area of the unit for extended periods of time. Excessive heat can deform or discolor the unit.
- When moved from one location to another where the temperature and/or humidity is very different, water droplets (condensation) may form inside the unit. Damage or malfunction may result if you attempt to use the unit in this condition. Therefore, before using the unit, you must allow it to stand for several hours, until the condensation has completely evaporated.

- Do not allow rubber, vinyl, or similar materials to remain on the unit for long periods of time. Such objects can discolor or otherwise harmfully affect the finish.
- Do not allow objects to remain on top of the keyboard. This can be the cause of malfunction, such as keys ceasing to produce sound.
- Do not paste stickers, decals, or the like to this instrument. Peeling such matter off the instrument may damage the exterior finish.

## Maintenance

- To clean the unit, use a dry, soft cloth; or one that is slightly dampened. Try to wipe the entire surface using an equal amount of strength, moving the cloth along with the grain of the wood. Rubbing too hard in the same area can damage the finish.
- Never use benzine, thinners, alcohol or solvents of any kind, to avoid the possibility of discoloration and/or deformation.

## Repairs and Data

- Please be aware that all data contained in the unit’s memory may be lost when the unit is sent for repairs. Important data should always be backed up on a floppy disk, or written down on paper (when possible). During repairs, due care is taken to avoid the loss of data. However, in certain cases (such as when circuitry related to memory itself is out of order), we regret that it may not be possible to restore the data, and Roland assumes no liability concerning such loss of data.

## Additional Precautions

- Please be aware that the contents of memory can be irretrievably lost as a result of a malfunction, or the improper operation of the unit. To protect yourself against the risk of losing important data, we recommend that you periodically save a backup copy of important data you have stored in the unit’s memory on a floppy disk
- Unfortunately, it may be impossible to restore the contents of data that was stored on a floppy disk and internal memory once it has been lost. Roland Corporation assumes no liability concerning such loss of data.
- Use a reasonable amount of care when using the unit’s buttons, sliders, or other controls; and when using its jacks and connectors. Rough handling can lead to malfunctions.
- Never strike or apply strong pressure to the display.
- A small amount of noise may be heard from the display during normal operation.
- When connecting / disconnecting all cables, grasp the connector itself—never pull on the cable. This way you will avoid causing shorts, or damage to the cable’s internal elements.

## IMPORTANT NOTES

- To avoid disturbing your neighbors, try to keep the unit's volume at reasonable levels. You may prefer to use headphones, so you do not need to be concerned about those around you (especially when it is late at night).
- When you need to transport the unit, pack it in shock-absorbent material. Transporting the unit without doing so can cause it to become scratched or damaged, and could lead to malfunction.
- Do not apply undue force to the music stand while it is in use.
- Use a cable from Roland to make the connection. If using some other make of connection cable, please note the following precautions.
  - Some connection cables contain resistors. Do not use cables that incorporate resistors for connecting to this unit. The use of such cables can cause the sound level to be extremely low, or impossible to hear. For information on cable specifications, contact the manufacturer of the cable.

## Before Using Floppy Disks

### Handling the Floppy Disk Drive

- Install the unit on a solid, level surface in an area free from vibration.
- Avoid using the unit immediately after it has been moved to a location with a level of humidity that is greatly different than its former location. Rapid changes in the environment can cause condensation to form inside the drive, which will adversely affect the operation of the drive and/or damage floppy disks. When the unit has been moved, allow it to become accustomed to the new environment (allow a few hours) before operating it.
- To insert a disk, push it gently but firmly into the drive—it will click into place. To remove a disk, press the EJECT button firmly. Do not use excessive force to remove a disk.
- Never eject a disk while reading or writing is in progress, since that can damage the magnetic surface of the disk, rendering it unusable. (The disk drive's indicator will light up at full brightness when the drive is busy reading or writing data. Ordinarily, the indicator will be less brightly lighted, or be extinguished.)
- Remove any disk from the drive before powering up or down.
- To prevent damage to the disk drive's heads, always try to hold the floppy disk in a level position (not tilted in any direction) while inserting it into the drive. Push it in firmly, but gently. Never use excessive force.
- To avoid the risk of malfunction and/or damage, insert only floppy disks into the disk drive. Never insert any other type of disk. Avoid getting paper clips, coins, or any other foreign objects inside the drive.

## Handling Floppy Disks

- Floppy disks contain a plastic disk with a thin coating of magnetic storage medium. Microscopic precision is required to enable storage of large amounts of data on such a small surface area. To preserve their integrity, please observe the following when handling floppy disks:
  - Never touch the magnetic medium inside the disk.
  - Do not use or store floppy disks in dirty or dusty areas.
  - Do not subject floppy disks to temperature extremes (e.g., direct sunlight in an enclosed vehicle). Recommended temperature range: 10 to 50° C (50 to 122° F).
  - Do not expose floppy disks to strong magnetic fields, such as those generated by loudspeakers.
- Floppy disks have a "write protect" tab which can protect the disk from accidental erasure. It is recommended that the tab be kept in the PROTECT position, and moved to the WRITE position only when you wish to write new data onto the disk.

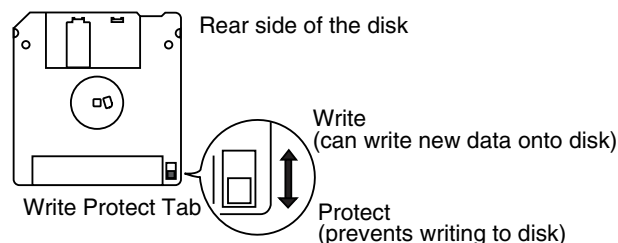

- The identification label should be firmly affixed to the disk. Should the label come loose while the disk is in the drive, it may be difficult to remove the disk.
- Store all disks in a safe place to avoid damaging them, and to protect them from dust, dirt, and other hazards. By using a dirty or dust-ridden disk, you risk damaging the disk, as well as causing the disk drive to malfunction.
- Disks containing performance data for this unit should always be locked (have their write protect tab slid to the "Protect" position) before you insert them into the drive on some other unit (except the PR-300, or a product in the HP-G, MT, KR, or Atelier families), or into a computer's drive. Otherwise (if the write protect tab remains in the "Write" position), when you perform any disk operations using the other device's disk drive (such as checking the contents of the disk, or loading data), you risk rendering the disk unreadable by this unit's disk drive.

\* GS (  ) is a registered trademark of Roland Corporation.

\* XG lite (  ) is a registered trademark of Yamaha Corporation.

\* All product names mentioned in this document are trademarks or registered trademarks of their respective owners.

# Main Features

We want to take a moment to thank you for your purchase of the Roland AT-5 “Atelier Series” Organ.

The AT-5 is an electronic organ which provides a generous collection of rich organ sounds. In addition, it is designed to be easy to learn and use. In order to enjoy reliable performance of your new keyboard for many years to come, please take the time to read through this manual in its entirety.

## ■ Basic Concepts of the ATELIER Series

### ○ A Full Complement of Organ Sounds

Basic organ sounds, ranging from jazz organ and pipe organ to theatre organ, are onboard so you are sure to enjoy having access to all the sounds you expect from an organ.

### ○ Panel Layout Based on a Tradition of Emphasis on Realtime Operation

Based on the idea that you should be able to sit down and begin playing immediately, the operation buttons of the panel are arranged by function as dictated by classic organ traditions, ensuring easy and intuitive operation. All models of the ATELIER series feature the same operability, allowing you to start playing immediately even if you switch models.

### ○ High-quality Sounds that You Can Use without Editing

In addition to a full range of organ sounds, high-quality sounds such as strings are also included onboard. You can simply select sounds and enjoy playing the organ no need to perform complicated editing operations.

### ○ Design Utilizes Your Existing Music Data

The ATELIER series is designed so that even on new models, you will feel right at home and can begin playing immediately. Data compatibility has also been carefully taken into account, and song data from earlier models can be used without change.

### ○ Music Styles From Around the World

The best-loved musical styles from around the world (rhythm and automatic accompaniment patterns) are built in, allowing you to enjoy an international range of performances.

### ○ Make Full Use of Music Files

Compatible with GM2, the world standard in SMF music files, and equipped with its own floppy disk drive, the AT-5 brings you access to the wealth of SMF music files available on the market. You can also mute parts, allowing you to practice the part for each hand separately, and enjoy performing ensemble with the music files.

## Main Features

---

### ■ Main Features of AT-5

#### ○ Highly Realistic Rhythms and Automatic Accompaniment Functions

All rhythms use data from performances by professional drummers, featuring high-quality patterns with all the grooves and subtle nuance of the real thing. In addition, you can use automatic accompaniments that are perfectly matched to each rhythm to enjoy the feeling of playing with your own band in the background.

#### ○ Complete Set of Basic Voice

The AT-5 includes not only organ voices, but strings, piano, guitar, brass, and other voices, providing a full complement of basic instrument voices. Each of the voices used is of the same high quality as those found in finer instruments.

#### ○ Developed Active Expression Sounds

For some of the sounds, moving the expression pedal will vary not only the volume but also the tone, or add other sounds. From pianissimo to fortissimo, the tonal character of the sound itself will change as you perform a crescendo, or strings may appear behind the piano, creating dynamic changes in tonality.

#### ○ Split Function

You can split the 61 keys into two separate registers, and play with a different voice in each. Additionally, you can use the lower registers as the part for the automatic accompaniment chord recognition, and the upper part for performing melody.

#### ○ Harmony Intelligence

The AT-5 features a built-in Harmony Intelligence function that automatically creates harmonies in the voices played in the upper part of the keyboard in accordance with the chords played in the lower part. This gives you greater tonal depth and a more powerful performance.

#### ○ High-Quality Reverb

Reverb (reverberation) is a critical element that is a must for organ performances. The AT-5 features high-quality internal reverb, allowing you to enjoy organ performances filled with presence.

### ■ Conventions Used in This Manual

- Button names are enclosed in square brackets (“[ ]”), as in [Harmony Intelligence] button.
- [+] [-], [▲] [▼], [◀] [▶] means that you should press one or the other button.  
Example: Value [-][+] buttons, Reverb [▲][▼] buttons, Tempo [◀][▶] buttons



# Contents

USING THE UNIT SAFELY .....	3
Important Notes .....	5
<b>Main Features .....</b>	<b>7</b>
<b>Panel Descriptions .....</b>	<b>12</b>
<b>Before You Start Playing .....</b>	<b>14</b>
Setting Up the Music Stand .....	14
Connecting the AC Adaptor .....	14
Turning the Power On and Off .....	14
Tuning On the Power .....	14
Turning Off the Power .....	15
Using Headphones .....	15
Restoring All the Factory Default Settings .....	16
Adjusting the Contrast of the Screen .....	16
Displaying Basic Screens .....	16
Rhythm Screen .....	16
Composer Screen .....	16
<b>Selecting and Playing Sounds .....</b>	<b>17</b>
Listening to the Demo Songs .....	17
Selecting Voices .....	19
Switching the Keyboard Settings .....	19
About the Voices and Parts .....	20
Functions of the Upper/Lower Sound Select Buttons .....	20
Selecting the Upper and Lower Voices .....	21
Selecting a Voice Using the Upper Orchestral [Others] Button .....	22
Using the Lower of the Keyboard to Play the Bass Voice ([Bass To Lower] Button) .....	23
Selecting Bass Voice .....	23
Adjust the Volume Balance .....	24
Transpose the Pitch in Octave Units (Octave Shift) .....	25
<b>Using the Rhythm Performance .....</b>	<b>26</b>
Selecting a Rhythm .....	26
Playing Rhythms (Starting and Stopping the Rhythm) .....	27
Starting at the Press of a Button .....	27
Stopping the Rhythm .....	28
Adding Variety to the Rhythm and Automatic Accompaniment .....	29
Changing the Tempo .....	29
A Simple Way to Make Automatic Accompaniment Settings (One Touch Program) .....	30
<b>Adding Various Effects to a Voice .....</b>	<b>31</b>
Adding Harmony to a Melody (Harmony Intelligence) .....	31
Changing the Type of Harmony Intelligence .....	32
Adding Modulation to the Sound (Rotary Effect) .....	33
Reverb Effect .....	34
Sustain Effect .....	35

## Contents

---

### **Using the Play Functions ..... 36**

Transposing to a Different Key (Transpose Buttons).....	36
Adjusting the Overall Volume Using an Expression Pedal.....	37
Adding Decay to the Sound (Damper Pedal) .....	37
Using the Foot Switch.....	38

### **Record and Playback Your Performance ..... 39**

Playing Back Performance Songs Stored on Floppy Disk.....	40
Silencing a Specific Track (Track Mute).....	42
Recording a Performance.....	43
Playing Back a Performance Song .....	45
Rerecording Performance Data Recorded on the AT-5.....	46
Erasing a Performance Song.....	47
Formatting Disks.....	48
Changing the Name of a Performance Song (Rename).....	50
Saving Performance Songs onto Floppy Disk.....	51
Deleting Performance Songs Stored on Disk .....	53
Layering a New Recording onto SMF Music Files.....	54
Re-recording a Performance Saved on Floppy Disk.....	55
Using Song with a Different Tempo Than That of the Performance Song.....	55

### **Settings for the Composer ..... 56**

Changing the Key When Playing Back Songs .....	56
Changing the Metronome Setting .....	56
Adjusting the Metronome Volume .....	57
Changing the Sound of the Metronome .....	57
Setting the Beat .....	58
Silencing a Specific Track .....	58
Muting Individual Channels of Performance Data .....	59
Re-recording the Bass Performance .....	60
Changing the Function of the Expression Pedal .....	60
Function During Recording .....	60
Function During Playback .....	61
Switching the Display of Lyrics On or Off .....	61

### **Adjusting the Effects ..... 62**

Sustain Effect .....	62
Changing the Sustain Length .....	62

### **Various Other Settings ..... 63**

Turning Initial Touch On/Off (Initial Touch) .....	63
Changing the Function of the Foot Switch (Left Foot SW, Right Foot SW) .....	63
Preventing Rhythm Tempos from Switching Automatically (Auto Standard Tempo) .....	64
Playing a Count Sound When the Intro Ends (Intro Count Down) .....	64
Changing the Sound of the Count Down (Count Down Sound) .....	64
Adjust the Standard Pitch (Master Tune) .....	65
Selecting the MIDI Transmit Channel (Tx MIDI Channel) .....	65

---

**Connecting with External Devices ..... 66**

Names and Functions of Jacks and Connectors .....66

Connecting Audio Equipment .....66

    Making the Connections .....66

If You're Using MIDI .....67

    Connecting the AT-5 to a MIDI Instrument .....67

**Appendices**

---

Troubleshooting .....68

Display Messages .....70

Chord List .....72

Glossary .....74

    About ATELIER Series Sound Generator .....75

MIDI Implementation Chart .....76

Demo Song List .....77

Index .....78

# Panel Descriptions

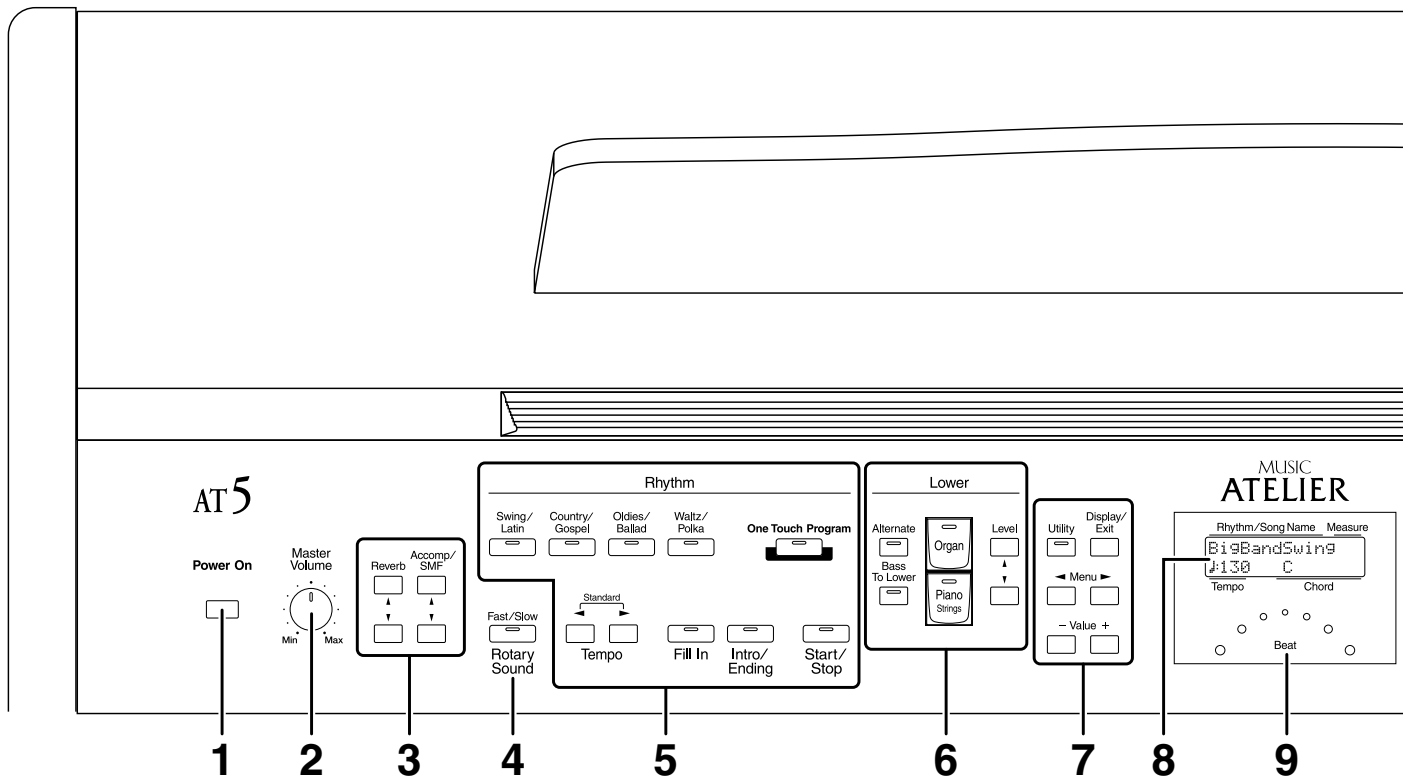

- |   |  |
|---|--|
| <p><b>1</b> [Power On] switch ( → p. 15)</p> <p><b>2</b> [Master Volume] knob ( → p. 15)</p> <p><b>3</b> Part Balance [▲] [▼] button ( → p. 24, p. 34)</p> <p><b>4</b> Rotary Sound [Fast/Slow] button ( → p. 33)</p> <p><b>5</b> Rhythm select buttons ( → p. 26)<br/>           Tempo [ ◀ ] [ ▶ ] button ( → p. 29)<br/>           Fill In button ( → p. 29)<br/>           [Intro/Ending] button ( → p. 27)<br/>           [Start/Stop] button ( → p. 27)<br/>           [One Touch Program] button ( → p. 30)</p> | <p><b>6</b> Lower Voice select buttons ( → p. 21)<br/>           Lower part<br/>           [Alternate] button<br/>           [Bass To Lower] button ( → p. 23)<br/>           Level [▲] [▼] button ( → p. 24)</p> <p><b>7</b><br/>           [Utility] button ( → p. 63)<br/>           [Display/Exit] button ( → p. 16)<br/>           Menu [ ◀ ] [ ▶ ] buttons<br/>           Value [-] [+] buttons</p> <p><b>8</b> Display ( → p. 16)</p> <p><b>9</b> Beat Indicator ( → p. 29)</p> |
|---|--|

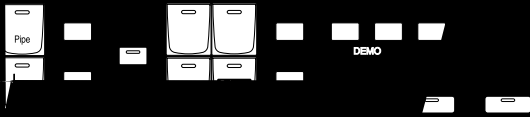

# Before You Start Playing

## Setting Up the Music Stand

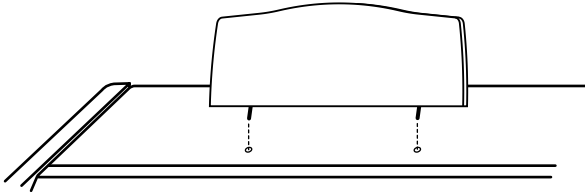

1. Attach the music stand by inserting it into the two holes.

## Connecting the AC Adaptor

1. First, make sure that the [Power On] switch at the panel's left side is OFF (not pushed in).
2. Connect the supplied AC adaptor and power cord.

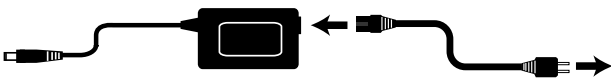

3. Connect the AC adaptor to the DC In jack on the rear panel.
4. Loop the AC adaptor cord around the cord hook to fasten it in place.

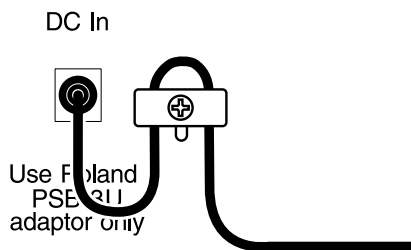

- \* To prevent the inadvertent disruption of power to your unit (should the plug be pulled out accidentally), to avoid applying undue stress to the DC In connector, anchor the power cord using the cord hook, as shown in the diagram. Even if the cord is fastened, strong tension applied to the cord may cause it to be damaged or broken. Be careful not to pull the cord accidentally, or to apply strong pressure to it.

5. Plug the power cord into a power outlet.

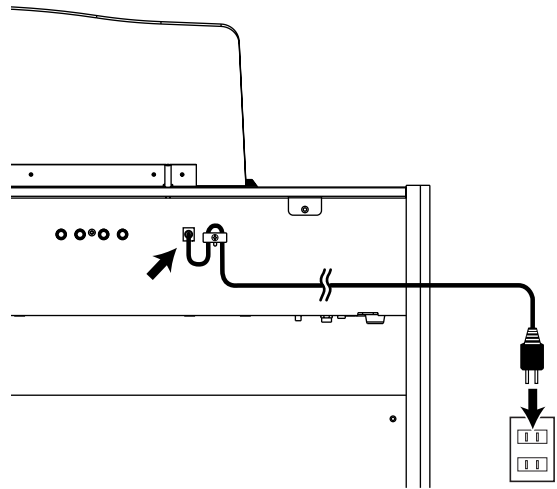

- \* Only use the power cord and AC adaptor supplied with this instrument.
- \* Whenever you do not intend to use the instrument for extended periods of time, pull out the power cord from the AC outlet.

Tu

\*

1

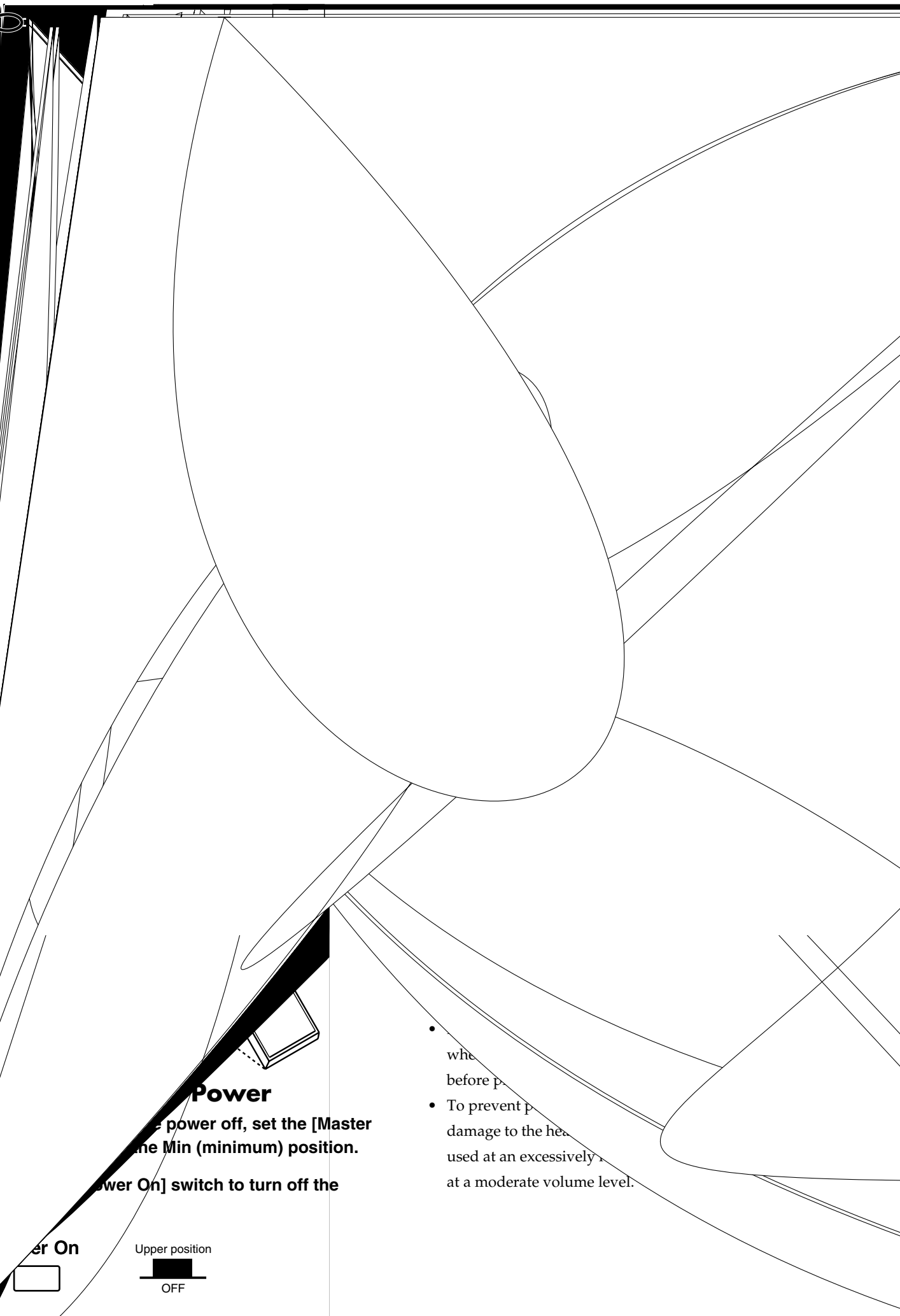

### Power

To power off, set the [Master Power On] switch to the Min (minimum) position.

Power On



Upper position



OFF

- when... before p...
- To prevent p... damage to the hea... used at an excessively... at a moderate volume level.

## Before You Start Playing

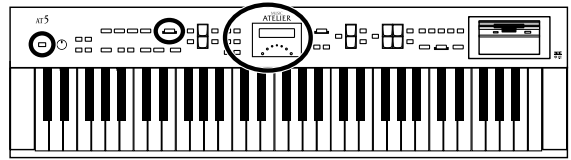

## Restoring All the Factory Default Settings

The settings stored in the AT-5 can be returned to their factory settings. This function is called "Factory Reset."

1. Make sure there is no floppy disk in the disk drive before carrying out the procedure.
2. Turning off the power.
3. While holding down the [One Touch Program] button, press the [Power On] switch to turn the power on.

Power On



One Touch Program



Do not turn off the power while the following screen is displayed.

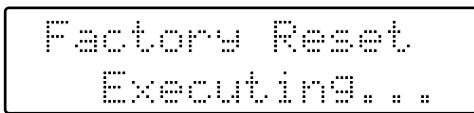

When factory reset is completed, the basic screen reappears.

## Adjusting the Contrast of the Screen

You can adjust the contrast of the screen.

1. Turn the [LCD Contrast] knob located at the bottom of the unit to adjust the contrast of the screen.

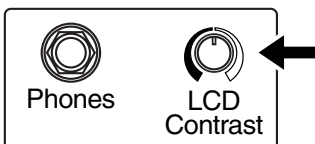

## Displaying Basic Screens

The instrument's display provides a large variety of information. The AT-5 has two types of basic display screen: the Rhythm display, and the Composer display. You can alternate from one to the other by pressing the [Display/Exit] button.

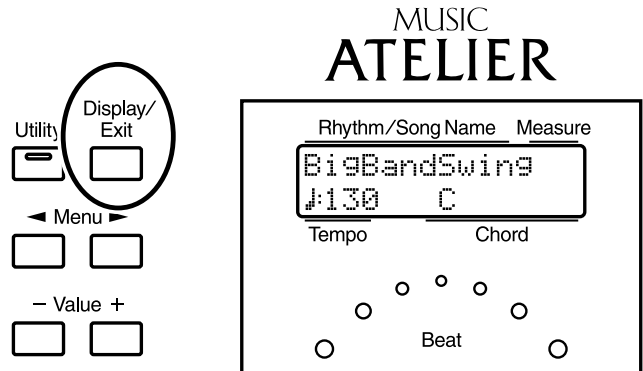

### ■ Rhythm Screen

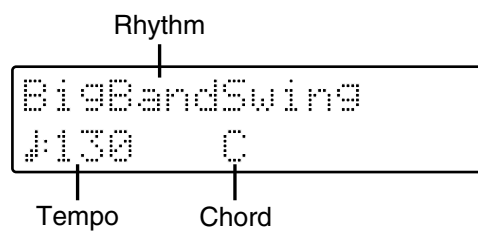

### ■ Composer Screen

When internal music data is selected:

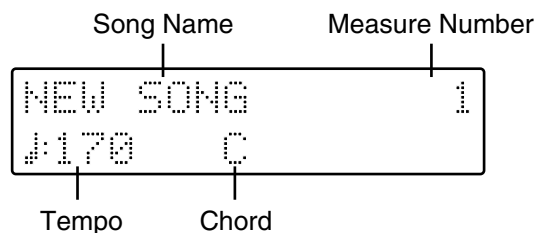

When you have selected a performance song on a floppy disk:

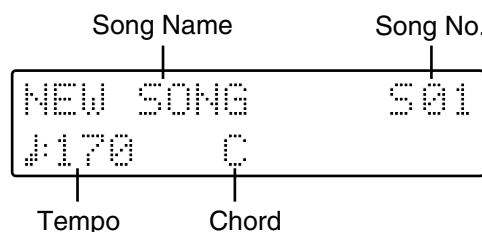



Play

to so  
ds, R  
-5.

mpo

Sele

Save

**1. Make sure that a floppy disk is in the drive.**

If a floppy disk is in the drive, the floppy disk is in the floppy disk.

**2. Press the Select key.**

**3. Press the Select key.**

**4. Press the [Play/Stop] key.**

When the selected demo screen is displayed, the [Play/Stop] key is pressed.

**5. To stop playback in the Stop position.**

## Selecting and Playing Sounds

### ○ If the following screen appears

If the performance song in the unit has not been saved to a floppy disk, the following message will appear, and it will not be possible to play the Demo songs.

```
Clear Song Sure?  
Yes:REC No:RST
```

If you don't mind erasing this song, press the [Rec] button. However, if you wish to save this song, press the [Reset] button to cancel the procedure, and then save the song onto a floppy disk.

### **MEMO**

If you wish to save the musical data to a floppy disk, refer to "Saving Performance Songs onto Floppy Disk" (p. 51).

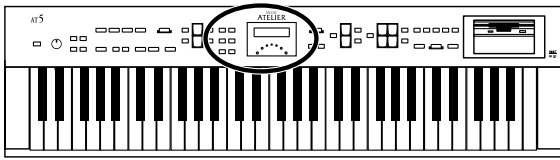

## Selecting Voices

The AT-5 is able to produce the sounds of various instruments. These sounds are called “Voices” (or tones). It is very easy to select voices.

### ■ Switching the Keyboard Settings

With the AT-5, you can have the Upper voice played over the entire keyboard, or split the keyboard into an Upper part and a Lower part and have a different voice played in each. Additionally, you can use the lower register as the part for the automatic accompaniment chord recognition, and the upper register for performing melody.

1. Press the [Utility] button.
2. Press the Menu [◀] and [▶] button to select “Keyboard Mode.”



3. Press the Value [-] [+] button to switch the keyboard settings.

Setting	Description
Upper	The Upper voice is played over the entire keyboard.
Split	The keyboard register is split into two sections, with the Upper voice played in the Upper part and the Lower voice played in the Lower part. Additionally, you can use the lower registers as the part for the automatic accompaniment chord recognition, and the upper part for performing melody.

Lower Register: C2–B3      Upper Register: C4–C7

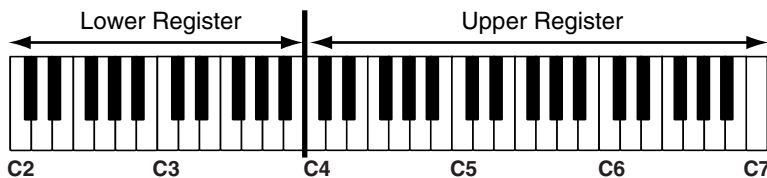

4. Press the [Utility] button.

The basic screen reappears.



When you press the [Bass To Lower] button, causing the indicator to light, you can have the Bass voice played as the root note (p. 74) when you play chords in the Lower part.

## Selecting and Playing Sounds

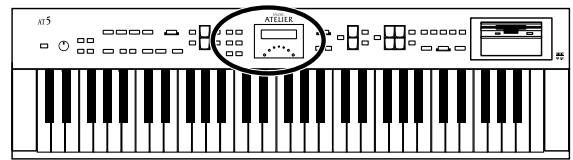

### ■ About the Voices and Parts

The Upper Register has two parts: “Organ,” “Orchestral.” You can select one voice for each of these parts, and you can layer the voices and play them together.

The Lower Register has the part: “Lower.”

Upper	Upper Organ
	Upper Orchestral
Lower	Lower
	Bass (This voice is sounded only when the [Bass To Lower] button lights up)

### ■ Functions of the Upper/Lower Sound Select Buttons

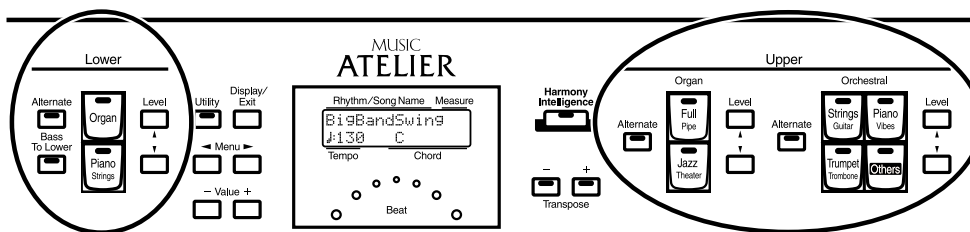

Each time you press a voice button, its indicator will switch between being lit and being turned off. Voices that have their button indicator lit can be played.

Two voices are assigned to both of the Lower Part and Upper Part button groups.

The [Alternate] button switches between these two voices.

The [Alternate] button	Voice that will be selected
The [Alternate] button is not lit.	The voice indicated on the button is selected.
The [Alternate] button is lit.	Another voice of the same family or the voice indicated on the bottom half of the button is selected.

#### MEMO

When you press the [Bass To Lower] button, causing the indicator to light, you can have the Bass voice played as the root note (p. 74) when you play chords in the Lower part.

#### NOTE

If none of the voice buttons are lit, playing the keyboard will not produce a sound.

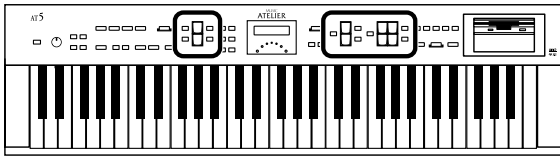

### ■ Selecting the Upper and Lower Voices

Select voices by pressing the Upper and Lower Part buttons.

**Example: Selecting “Jazz Organ2” for the Upper Organ part, and “Grand Piano” for the Upper Orchestral part.**

#### 1. Press the Upper Organ [Jazz] button (indicator lights).

The name of the selected voice appears in the display for several seconds.

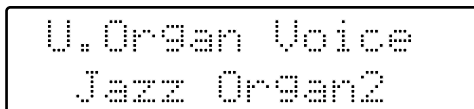

When you play in the Upper part of the keyboard, the “Jazz Organ2” voice is played.

#### 2. Press the Upper Orchestral [Piano] button (the indicator lights).

Now when you play the upper part of the keyboard, the two voices “Jazz Organ2” and “Grand Piano” will sound simultaneously (mixed together).

You can select the Lower voices, just as you can the Upper voices.

#### **NOTE**

Playing the Lower voice requires splitting the keyboard into Lower and Upper parts (p. 19).

## Selecting and Playing Sounds

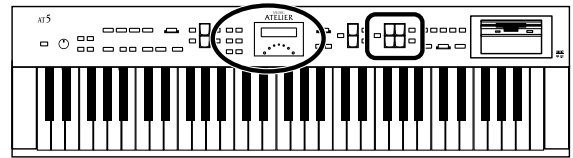

### ■ Selecting a Voice Using the Upper Orchestral [Others] Button

Notice that there is an Upper Orchestral [Others] button. By using the Upper Orchestral [Others] button, you can select all voices.

#### 1. Press the Upper Orchestral [Others] button.

The voice name appears in the display.

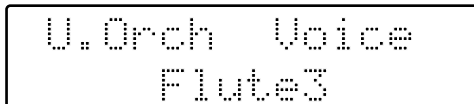

The indicator of the Upper Orchestral [Others] button will light.

#### 2. Press the [Alternate] button and select the voices to assign, either with the [Alternate] button ON (lit) or OFF (unlit).

#### 3. While the voice name is shown in the display screen, use the Value [-] [+] buttons to select the desired voice.

The indicator of the Upper Orchestral [Others] button will blink.

To stop mid-way through this or any procedure, press the [Display/Exit] button.

#### 4. Once again, press the Upper Orchestral [Others] button to confirm the voice.

The indicator of the Upper Orchestral [Others] button will change from blinking to lit.



You can jump by voice group by pressing the Menu [◀] [▶] buttons to select the voice group. The sound number of each voice is preceded by an alphabetical character A–T which indicates the sound group; e.g., “G15 Strings5.”



You can establish the voice by playing in the keyboard’s Upper part.



About the voices that can be assigned to an Upper Orchestral [Others] button, refer to the Leaflet of AT-5 specifications.

---

## Using the Play the

---

You  
ch

### 1. P

V  
P

■ S

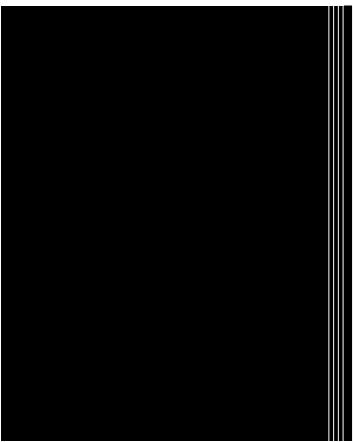
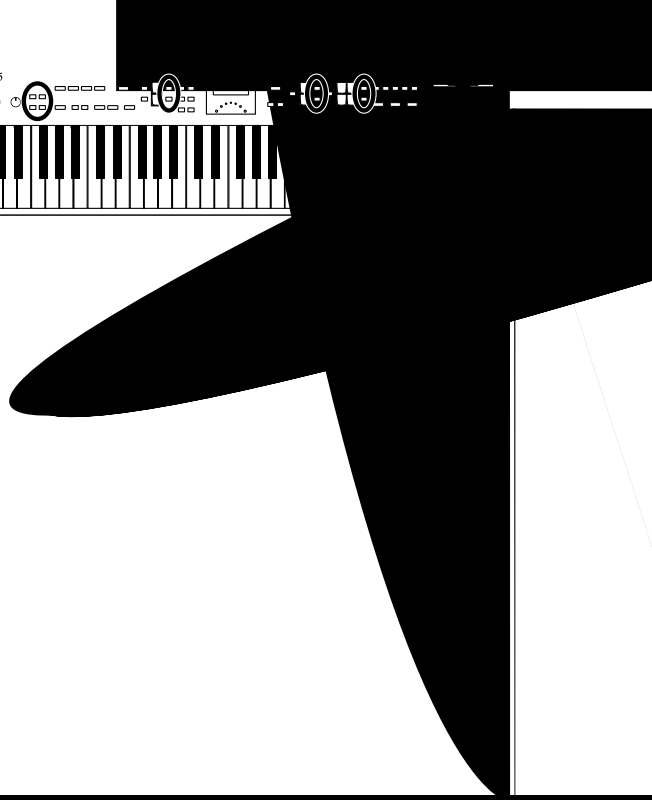
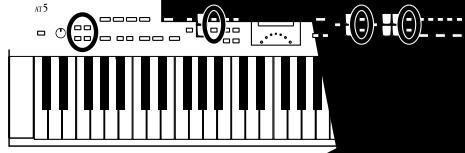





# Transpose the Pitch in Octave Units (Octave Shift)

The pitch of the sound played by the keyboard can be adjusted in one-octave steps.

You can apply an Octave shift to the following three Parts:

The Upper Organ Part, Upper Orchestral Part

The Lower Part

1. Press the [Utility] button.
2. Press the Menu [◀] and [▶] button to select "Octave Shift."

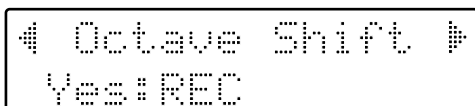

3. Press the [Rec] button.
4. Use the Menu [◀] and [▶] button to select a performance Part to which you wish to apply an Octave Shift.

Part: **Lower, U. Organ, U. Orch**

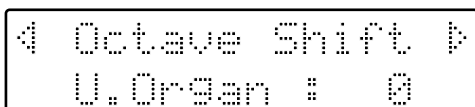

5. Use the Value [-] and [+] buttons to set the amount of shift.

The value can be set to a range of +/- 3 octaves.

6. Press the [Utility] button.

The basic screen reappears.

### NOTE

Please note that when you apply the Octave Shift function to certain voices, their pitch could be stretched beyond their recommended note ranges, and they may not sound as expected. Care should be taken when using Octave Shift.

# Using the Rhythm Performance

The AT-5 lets you enjoy playing along with a rhythmic accompaniment.

## Selecting a Rhythm

The AT-5 features a variety of internal rhythms. These are organized into four groups.

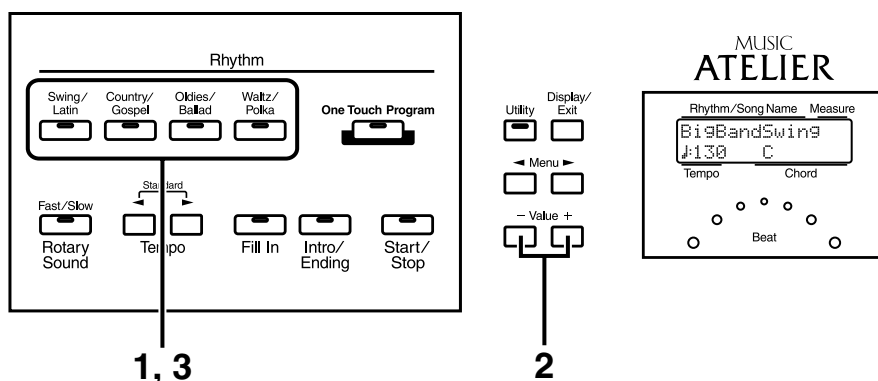

### 1. Press a Rhythm button to select a Rhythm group.

The indicator of Rhythm button will light.

That Rhythm will be shown in the display.



### 2. Press the Value [-] and [+] buttons to select a different Rhythm within the same group.

The indicator of the Rhythm button will blink.

### 3. Press the flashing rhythm button once more.

The Rhythm button's indicator will change from blinking to light.

The Rhythm has now been applied.



For more on the internal rhythms, refer to the leaflet of AT-5 specifications.



You can confirm the rhythm by playing the rhythm after it has been selected.

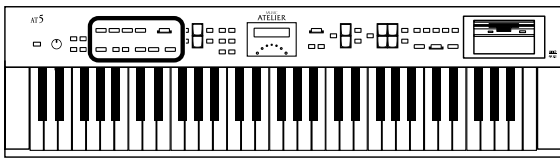

# Playing Rhythms (Starting and Stopping the Rhythm)

To start the rhythm, press the [Intro/Ending] button or the [Start/Stop] button.

You can also make the Rhythm start after playing an Intro, or make the Rhythm stop after playing an Ending.

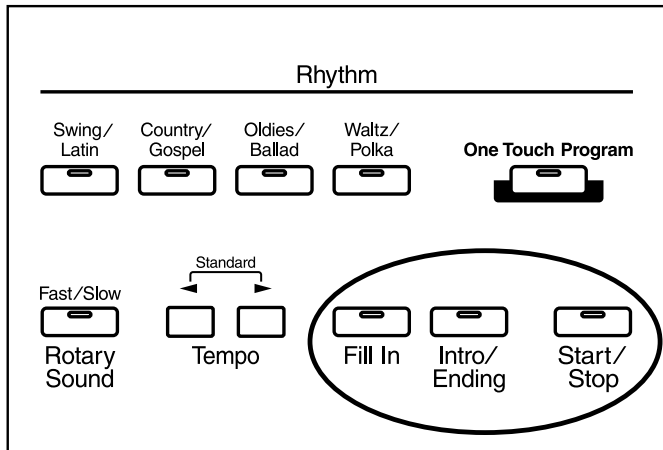

## ■ Starting Rhythms by Pressing the Buttons

### ○ Starting with an Intro

1. Press the [Intro/Ending] button.

The Intro is played and the Rhythm starts.

While the Intro is playing, the [Intro/Ending] button indicator will light, until the Intro ends then the button indicator will go dark.

### ○ Making the Intro Short and Simple

1. Press the [Fill In] button for a few seconds.

[Start/Stop] and [Fill In] button's indicators will blink.

2. Press the [Start/Stop] button.

A short Intro is played and the Rhythm starts.

### ○ Starting without an Intro

1. Press the [Start/Stop] button.

The Rhythm starts without an Intro being played.

## Using the Rhythm Performance

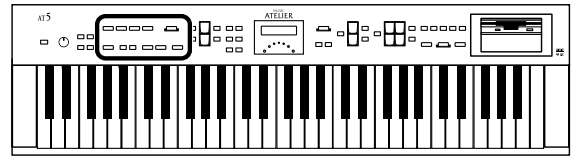

### ■ Stopping the Rhythm

#### ○ Stopping with an Ending

1. Press the [Intro/Ending] button.

An Ending is played, then the Rhythm stops.

While the Ending is playing, the [Intro/Ending] button indicator lights, until the Ending finishes the button indicator will be turned off.

#### ○ Making the Ending Short and Simple

1. Press the [Fill In] button, and then press the [Start/Stop] button.

A short Ending is played, then the Rhythm stops.

#### ○ Stopping without an Ending

1. Press the [Start/Stop] button.

The Rhythm stops without an Ending being played.

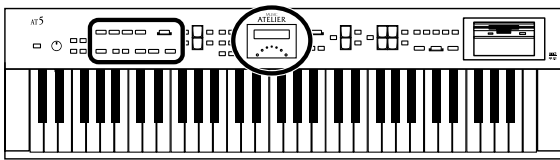

## Adding Variety to the Rhythm and Automatic Accompaniment

You can add variation to the Rhythm by changing the arrangement or by switching the Rhythm pattern.

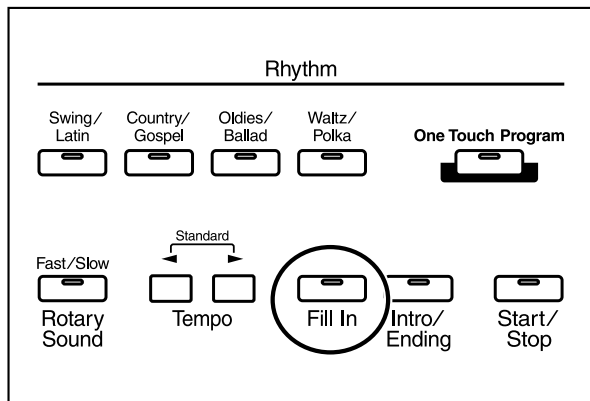

[Fill In] Button	Function
Lit	After the fill-in has played, play the Variation Rhythm pattern.
Unlit	After the fill-in has played, play the Original Rhythm pattern.

### What is a Fill In?

Fill-ins are short phrases inserted at the ends of melodies (between measures) and in sections of song where the mood changes.

## Changing the Tempo

You can change the tempo of the Rhythm or Automatic Accompaniment.

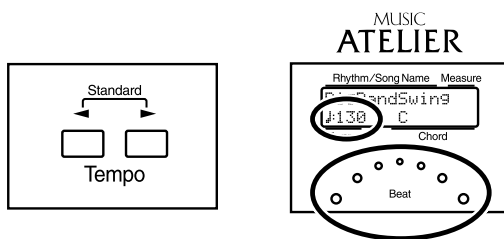

1. Press the Tempo [ ◀ ] and [ ▶ ] buttons to change the tempo (speed) of the Rhythm and Automatic Accompaniment.

Tempo [ ◀ ] button	The tempo becomes slower
Tempo [ ▶ ] button	The tempo becomes faster

The value of the tempo currently set (20–500 beats per minute) can be checked in the display.

You can also check the tempo by viewing the Beat indicator.



If you switch rhythms when “Auto Standard Tempo” (p. 64) is on, the tempo changes to match the rhythm. If you switch rhythms when “Auto Standard Tempo” is off, the tempo remains unchanged even when you switch the rhythm.



By pressing the Tempo [ ◀ ] and [ ▶ ] buttons simultaneously, the tempo is returned to the standard (preset) tempo for the selected Rhythm.

# A Simple Way to Make Automatic Accompaniment Settings (One Touch Program)

When using the Arranger function for automatic accompaniment, you can also use the “One Touch Program” function to automatically select panel settings that are appropriate for the selected rhythm.

### One Touch Program

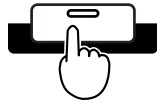

By pressing the [One Touch Program] button, you can make the following settings.

- Panel settings (e.g., sounds and volume) suitable for the rhythm
- Automatic Accompaniment playing
- Status with the keyboard split into Lower and Upper parts  
Lower Part: C2–B3      Upper Part: C4–C7
- [Intro/Ending] button blinking (Waiting for Sync Start)

### What is Sync Start?

Sync Start is the name for the function that simultaneously starts the rhythm when you play in the lower registers of the keyboard.

- Chord Intelligence function is ON

### What is Chord Intelligence?

“Chord Intelligence” is a feature that intelligently decides on accompaniment chords the moment you play some keys specifying a chord during automatic accompaniment.

## 1. Select a Rhythm (p. 26).

## 2. Press the [One Touch Program] button.

Panel settings appropriate for the rhythm and automatic accompaniment will automatically be called up.

## 3. On the lower of the keyboard, play a chord.

At the moment you play the lower of the keyboard, the Intro will begin, and then the Rhythm and Automatic Accompaniment will play.

## 4. Press the [Intro/Ending] or [Start/Stop] button to stop the Rhythm.

Rhythm and Automatic Accompaniment stops.

## 5. Press the [One Touch Program] button, extinguishing its indicator.

The One Touch Program function is turned off, and the panel settings in effect prior to the [One Touch Program] button being pressed are restored.



For more information about chord fingering, refer to the “Chord List” (p. 72).

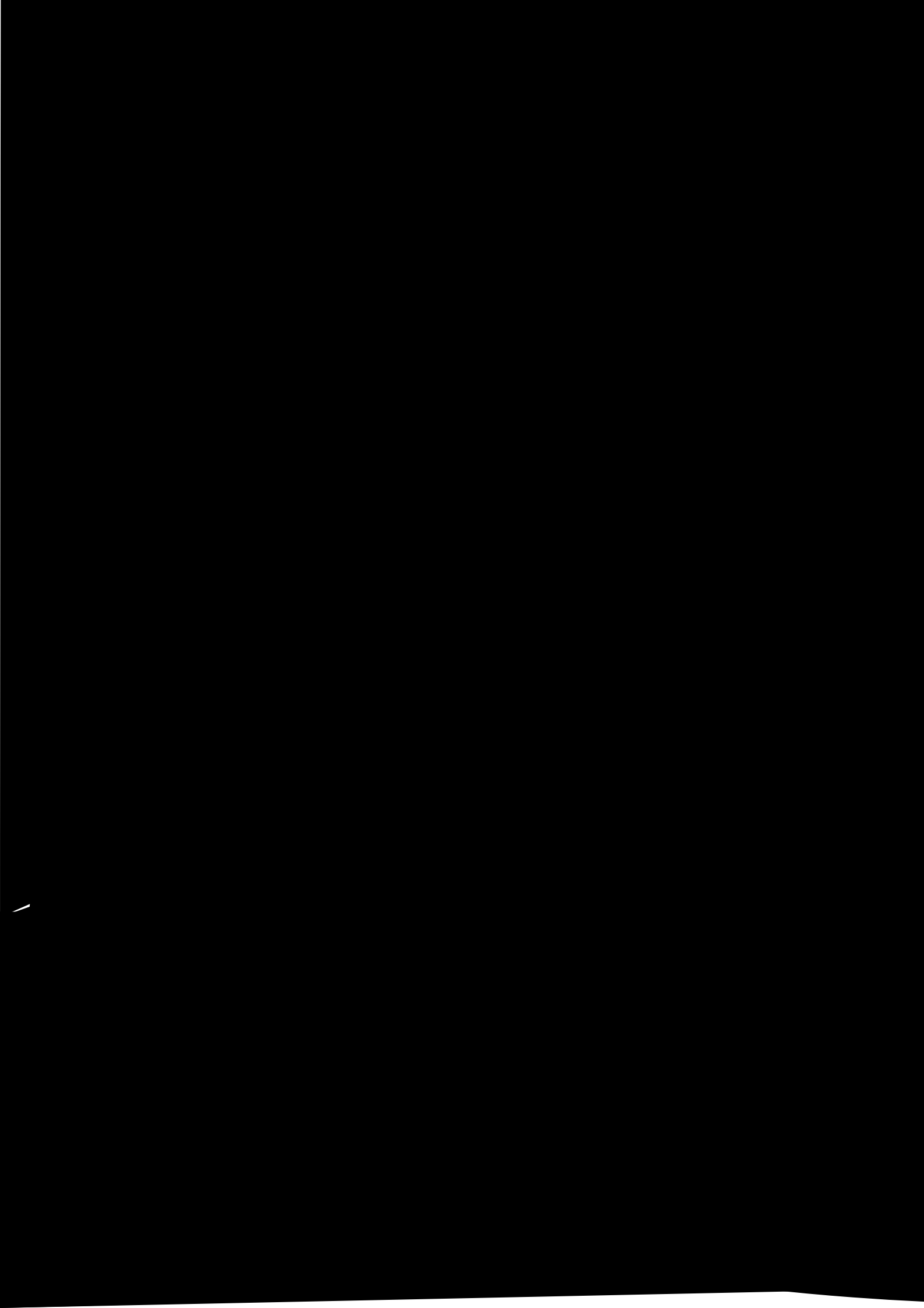

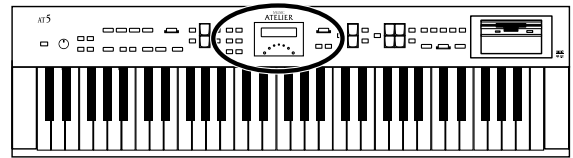

## Changing the Type of Harmony Intelligence

There are two different Harmony Intelligence.

When you press the [Harmony Intelligence] button, the most appropriate voice(s) will be automatically set.

The manner in which notes will sound also depends on the Harmony type.

- 1. Press the [Harmony Intelligence] button (indicator lights).**
- 2. While the Harmony Intelligence name is shown in the display screen, use the Value [-] [+] buttons to select the Harmony Intelligence.**

The indicator of the [Harmony Intelligence] button will blink.

To cancel the procedure, press the [Display/Exit] button.

- 3. Once again, press the [Harmony Intelligence] button.**

The indicator of the [Harmony Intelligence] button will light, and the Harmony Intelligence is confirmed.

Harmony Intelligence types:

Type	Upper Organ	Upper Orchestral	Number of notes of the harmony
<b>STRINGS</b>	–	Strings 5	4
<b>TRADITIONAL</b>	Currently Selected Voice		3

Harmonies are added only to the Upper voice.



You can also play the upper part of the keyboard to confirm the type of the Harmony Intelligence.



The number of notes of the harmony will depend on the Harmony Intelligence type.



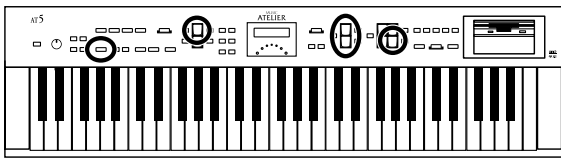

## Adding Modulation to the Sound (Rotary Effect)

Rotary is an effect which simulates the sound of rotating speakers. There is a choice of two settings: Fast and Slow.

The Rotary effect can be applied to the following sounds.

- Full Organ, Jazz Organ, Lower Organ



Some sounds do not allow the Rotary effect to be applied. For details refer to the Leaflet of AT-5 specifications.

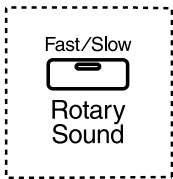
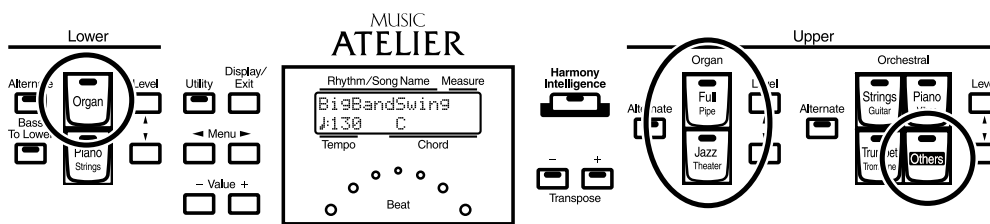

1. Select the voice to which you wish to apply the Rotary effect.
2. Press the Rotary Sound [Fast/Slow] button to switch between Rotary Fast (LED lit) and Rotary Slow (LED turned off).

<b>LED lit (Fast)</b>	The effect obtained is equivalent to speakers being rapidly rotated.
<b>LED turned off (Slow)</b>	Effect simulating the slow rotation of speakers.

When you switch the rotary effect from “Fast” to “Slow,” the modulation will slow down gradually, and when you switch from “Slow” to “Fast” the modulation will speed up gradually.



You can assign the Rotary Sound [Fast/Slow] button function to the foot switches located on each side of the Expression Pedal (p. 63).

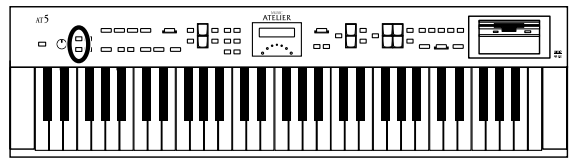

## Adding Various Effects to a Voice

### Reverb Effect

Reverb is an effect that adds a sense of spaciousness to the sound, creating the illusion of playing in a concert hall.

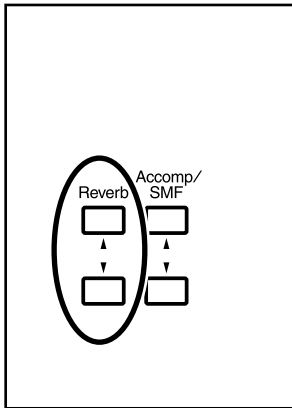

1. Press the Reverb [▲] or [▼] buttons to adjust the overall Reverb amount.

When you press the up button [▲], additional Reverb is applied. Pressing the down button [▼] decreases the Reverb level.

When you press the Reverb [▲][▼] buttons, the Reverb level will be shown in the display.



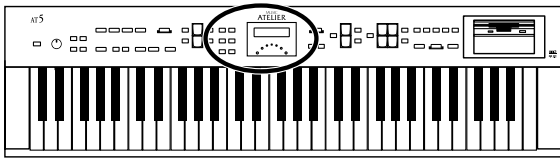

### Sustain Effect

Sustain allows you to add a decay to each voice after the keys are released. The Sustain effect can be added simultaneously to the Upper and Lower parts.

1. Press the [Utility] button.
2. Press the Menu [◀] and [▶] buttons to select the "Sustain."

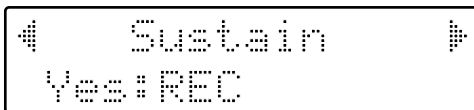

3. Press the [Rec] button.
4. Press the Menu [◀] and [▶] buttons to select the keyboard register to which the sustain effect is to be applied.

Register: **Upper, Lower**

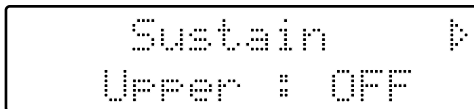

5. Press the Value [-] and [+] buttons to switch ON or OFF.
6. Press the [Utility] button.

The basic screen reappear.

#### **MEMO**

The length of Sustain can be modified independently for each part (p. 62).

# Using the Play Functions

## Transposing to a Different Key (Transpose Buttons)

You can transpose the key of a performance without having to shift the position of your fingers on the keyboard. This feature is called “Key Transpose.”

For example: you may play in the familiar C major scale while your music will sound in any key of your choice.

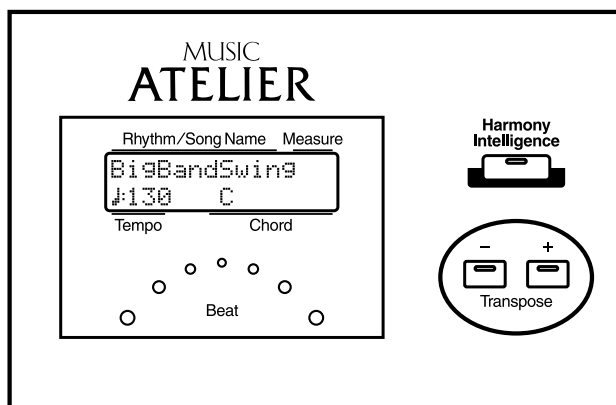

### 1. Press the Transpose [-] and [+] buttons.

Each press of the Transpose [-] or [+] button transposes the key a semitone.

The transpose value is displayed in the screen.

Acceptable values range from A $\flat$  to G (in semitone steps).

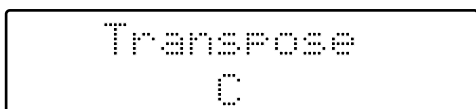

If the pitch is transposed (something other than C), the indicator of one of the Transpose buttons, either [-] or [+], will be lit. If the pitch is not transposed (i.e., the key is C), the indicator of both the Transpose [-] and [+] buttons will be extinguished.



By pressing the Transpose [-] [+] buttons simultaneously, you can restore the default setting C.

## Adjusting the Overall Volume Using an Expression Pedal

You can adjust the entire volume using an Expression Pedal. When you depress the Expression Pedal, the volume increases. The volume decreases as you tilt the pedal back.

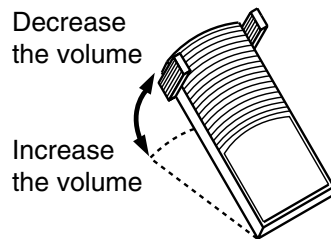

### MEMO

You can specify whether the Expression Pedal will or will not control the volume during the recording of music data (p. 60).

### MEMO

You can specify whether or not the Expression Pedal will affect the playback and what you play while Atelier music data is being played back (p. 61).

## Adding Decay to the Sound (Damper Pedal)

You can connect a damper pedal (sold separately) and use it to produce a lingering effect for the notes you play on the upper of the keyboard.

1. Connect the damper pedal (sold separately) to the damper pedal jack on the AT-5's rear panel.

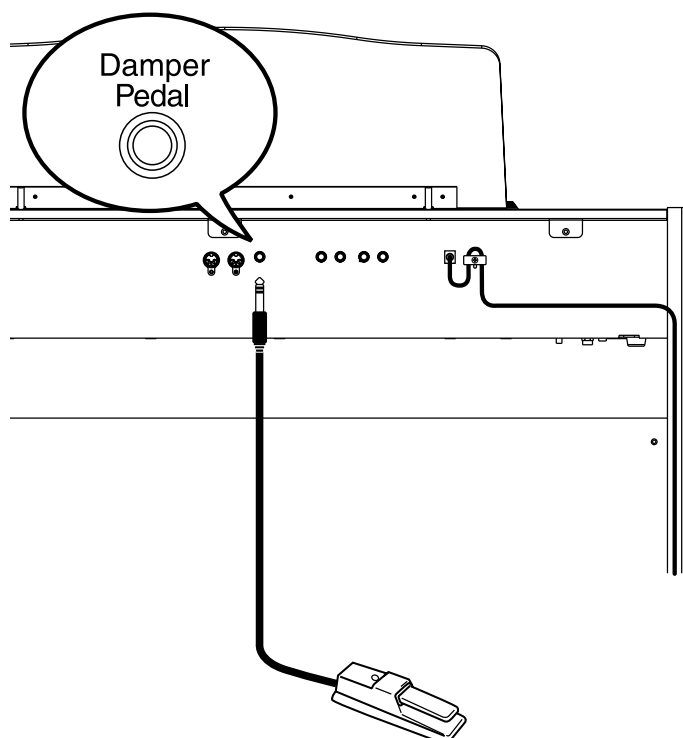

While you continue depressing the damper pedal, notes will be sustained even if you release the keys.

## Using the Play Functions

# Using the Foot Switch

On each side of the expression pedal is a Foot Switch. Different functions are assigned to each of these two foot switches.

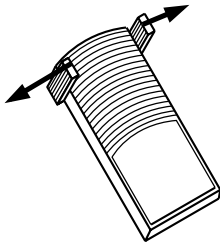

With the factory settings, the following functions are assigned to the left and right Foot Switches.

<b>Right Foot Switch</b>	Switch the Rotary effect between Fast/Slow.
<b>Left Foot Switch</b>	Glide (an effect by which the pitch is lowered by a semitone while the foot switch is pressed, and is returned to what is originally was when you release your foot).

### **Press the right Foot Switch toward the right.**

The Rotary effect will switch between “Fast” and “Slow” each time you press the Right Foot Switch.

### **Press the left Foot Switch toward the left.**

While you are pressing the Foot Switch, the pitch will be temporarily lowered. When you release the Left Foot Switch, the pitch will return to normal.

## **MEMO**

You can also change the function assigned to the Foot Switches. Please refer to “Changing the Function of the Foot Switch (Left Foot Sw, Right Foot Sw)” (p. 63).

# Record and Playback Your Performance

You can use the AT-5's internal Composer feature to record performances and to play back commercial SMF format music files.

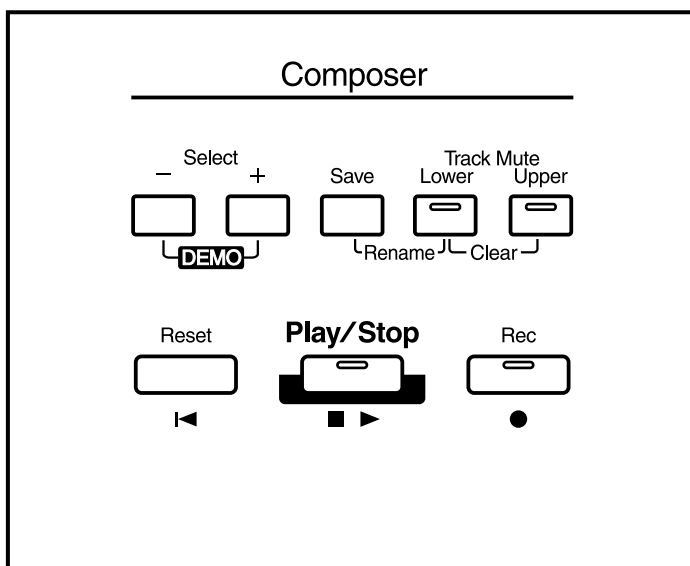

What you can do
<p><b>“Play back SMF music files”</b></p> <p>You can use the floppy disk drive to play back commercially available music files, and enjoy a wide variety of songs.</p>
<p><b>“Preventing the Sounds on a Specific Track from Playing”</b></p> <p>You can temporarily mute the sounds on specific tracks. This allows you to practice with the left or right part muted.</p>
<p><b>“Record your own performances”</b></p> <p>You can record the music that you play. You can also record your performances while playing rhythms or automatic accompaniment.</p>
<p><b>“Play back recorded performances”</b></p> <p>You can play back recorded performance data and check out how you sound.</p>
<p><b>“Save recorded performances on floppy disk”</b></p> <p>Any music you record will be discarded as soon as you turn off the power on the AT-5. However, by saving your performance data on a floppy disk, you can go ahead and switch off the power, and you'll still be able to load the performance data from floppy disk afterwards and enjoy hearing it again.</p>
<p><b>“Record a performance along with SMF music files”</b></p> <p>While playing back SMF music files, you can add your own performance and record it.</p>

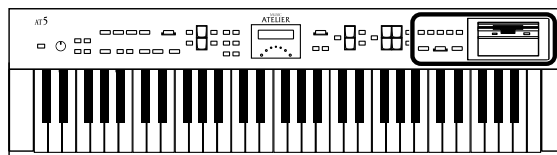

## Playing Back Performance Songs Stored on Floppy Disk

In addition to playing back the music you recorded on the instrument and saved to a floppy disk, AT-5 also lets you enjoy a wide variety of commercially available SMF music files.

### SMF Music Files

The Standard MIDI File (SMF) format was designed to provide a means for exchanging performance data among a wide variety of devices. In addition to the song files described earlier, the AT-5 is also capable of playing back any Standard MIDI File compatible with the General MIDI 2 or GS formats.



If you wish to purchase SMF music files, please contact the dealer where you purchased the AT-5.

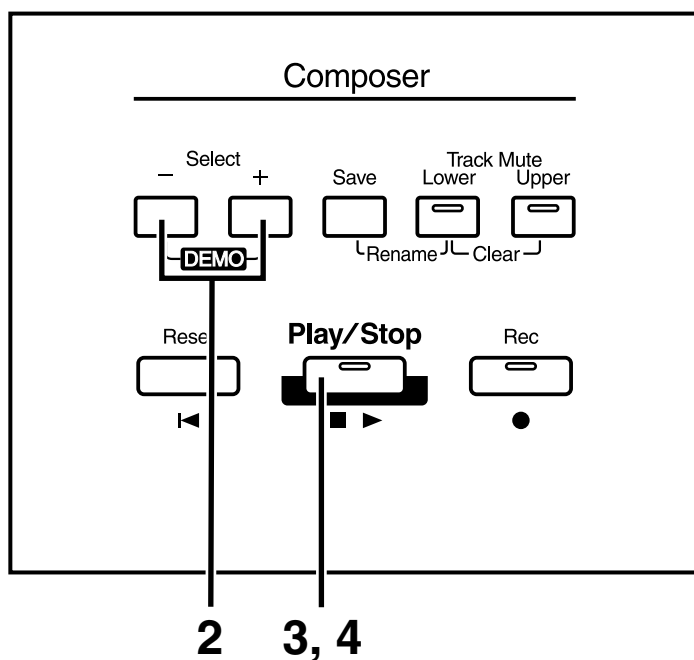

1. Insert a floppy disk containing commercially available SMF music files into the floppy disk drive.

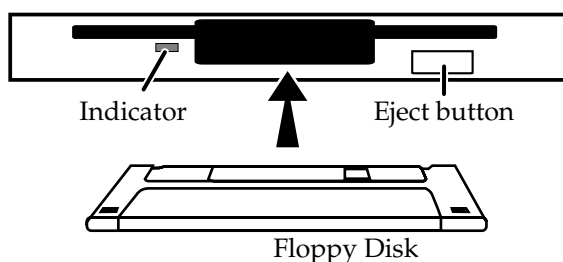

### NOTE

Never eject a disk while reading or writing is in progress, since that can damage the magnetic surface of the disk, rendering it unusable. (The disk drive's indicator will light up at full brightness when the drive is busy reading or writing data. Ordinarily, the indicator will be less brightly lit, or be extinguished.)



When the performance song loaded from a disk is a Standard MIDI File, " :;: " will be displayed after the file name.



- 2.** Press the Select [-] and [+] buttons to select the song.
- 3.** Press the [Play/Stop] button to start playback.  
Playback of the performance data begins.
- 4.** To stop playback, press the [Play/Stop] button.
- 5.** Press the eject button.

The floppy disk is ejected a little out of the slot. Gently grasp the end of the floppy disk and pull it out.

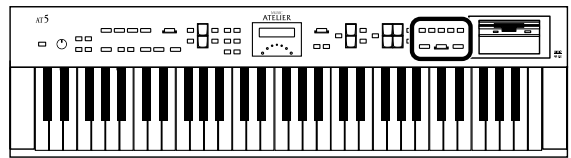

## Silencing a Specific Track (Track Mute)

The indicators for Track Mute button in which performances were recorded will be lit. By turning off these Track Mute button indicators, you can temporarily silence the sound. This is referred to as “Track Mute.”

You can practice with the melody muted.

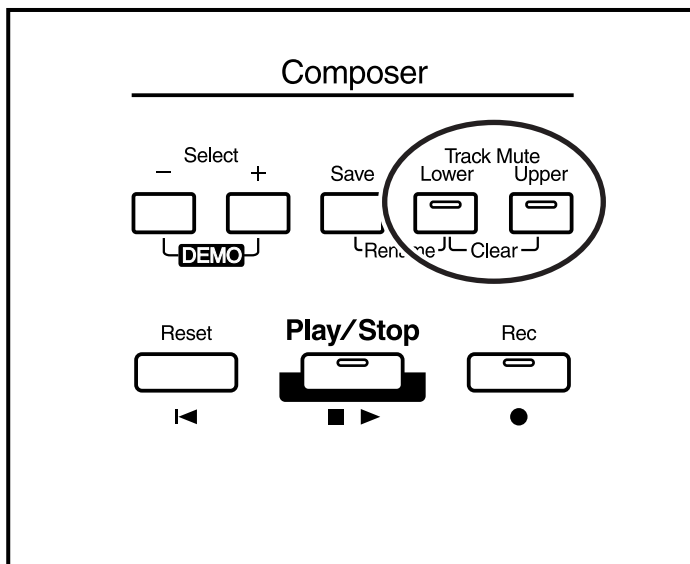

You can also change the Track Mute Settings in the Utility menu. In the Utility menu’s Track Mute you can mute the Rhythm track, accompaniment track, the bass track, and the control track (expression pedal and panel operations) (p. 58).

1. Press the [Track Mute] button whose indicator is lit to turn the light off.

The track whose indicator was turned off will be muted (silenced).

2. Press the [Track Mute] button once again (indicator lights).

The part that had been muted will return to normal and will be heard.

### ■ Assignments to the [Track Mute] Button When Playing Back Commercial SMF Music Files

Button	Channel
[Lower]	3
[Upper]	1, 4

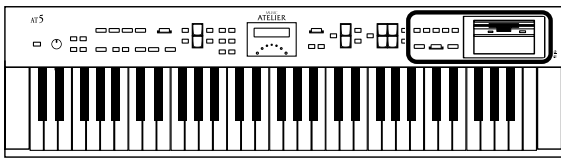

## Recording a Performance

You can record the performance that you play. You can also record your performance while playing rhythms or automatic accompaniment.

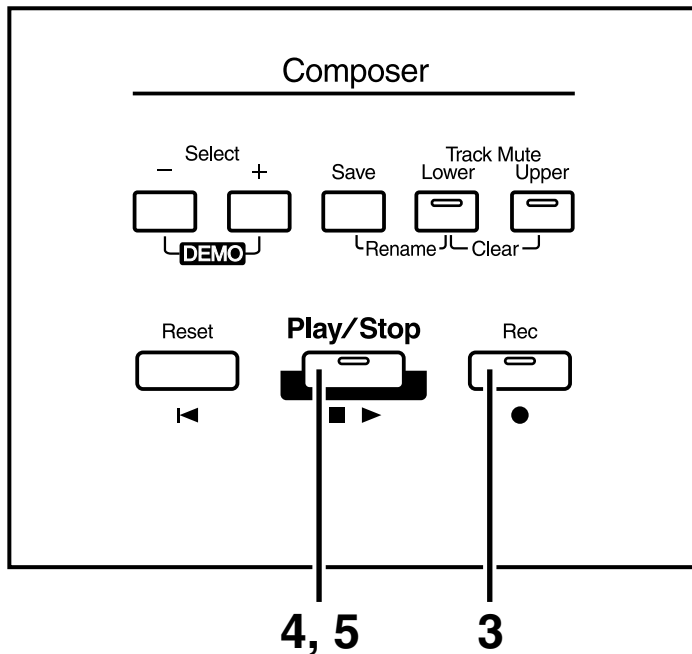

- 1.** Select the panel settings needed for recording the performance.
- 2.** Make sure that a floppy disk is not inserted in the disk drive.  
If a floppy disk is in the disk drive, press the Eject button (p. 41) and remove the floppy disk.
- 3.** Press the Select [-] and [+] buttons to select "NEW SONG."
- 4.** Enter the recording standby mode by pressing the [Rec] button.

The [Rec] button's indicator will light. The [Play/Stop] button indicators will blink.

- 5.** Press the [Play/Stop] button to start recording.

When you press the [Play/Stop] button, the metronome will play two measures (bars) of count-in before recording begins.

If you wish to use Rhythm and Automatic Accompaniment as you record, press the [Start/Stop] button instead of the [Play/Stop] button to begin recording.

- 6.** Press the [Play/Stop] button when you have completed your recording.

### MEMO

When you press the [Intro/Ending] button (or [Start/Stop] button) while recording a Rhythm performance or Automatic Accompaniment, the Rhythm performance and Automatic Accompaniment will stop. However, the recording itself will continue. Press the [Play/Stop] button to stop recording.

## Record and Playback Your Performance

If you press the [Rec] button when a song has been selected from the floppy disk, the selected song will be completely loaded into the AT-5 and the Composer will enter into the recording standby mode.

If you wish to record a new song, press the Select [-] and [+] buttons to first select "NEW SONG" before pressing the [Rec] button. Alternatively, eject the disk from the floppy disk drive before pressing the [Rec] button.

```
NEW SONG      1
#120
```

### ○ If the following screen appears

The following message appears when the AT-5 contains performance data that has not been saved to a floppy disk.

```
Clear Song Sure?
Yes:REC No:RST
```

### ● If you wish to erase the performance song

1. Press the [Rec] button.

### ● If you wish to save the performance song on a floppy disk

1. Press the [Reset] button to cancel the procedure.
2. Save the song onto a floppy disk (p. 51).

### ○ If the following screen appears

```
Memory Full
```

When recording was automatically canceled because the memory limit was reached.

```
Internal Memory
Near Limit
```

When the instrument's memory is nearing capacity.

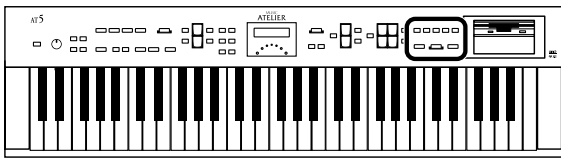

## Playing Back a Performance Song

Play back the performance recorded on the AT-5.

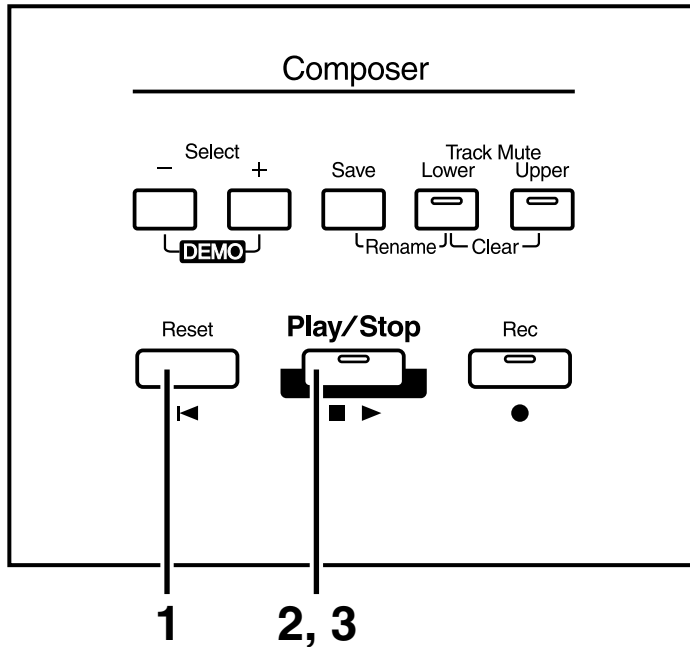

### 1. Press the [Reset] button.

The location at which playback will start will return to the beginning of the first measure (bar).

### 2. Press the [Play/Stop] button to start playback.

After playback reaches the end of the performance, it will stop automatically.

### 3. To stop playback at any point, press the [Play/Stop] button.

#### MEMO

If you press the [Play/Stop] button while holding down the [Reset] button, the metronome will play two measures (bars) of count-in before playback starts.

#### MEMO

You can specify whether or not the Expression Pedal will affect the playback and what you play while Atelier music data is being played back (p. 61).

#### NOTE

If you use the Rhythm or Automatic Accompaniment immediately after having loaded and played back a song other than an Atelier performance song, such as SMF's, etc., the playback may not sound right (the voices may have changed, etc.) To prevent this from happening, press the [Reset] button before playback.



or sounds may  
during playback

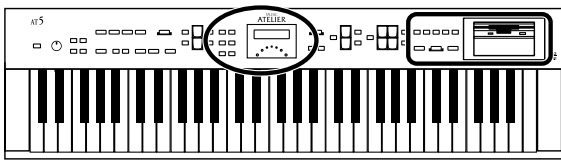

### Erasing a Performance Song

If you wish to discard your recording and re-record from the beginning, or if you wish to record a new performance, you must erase the previously-recorded data.

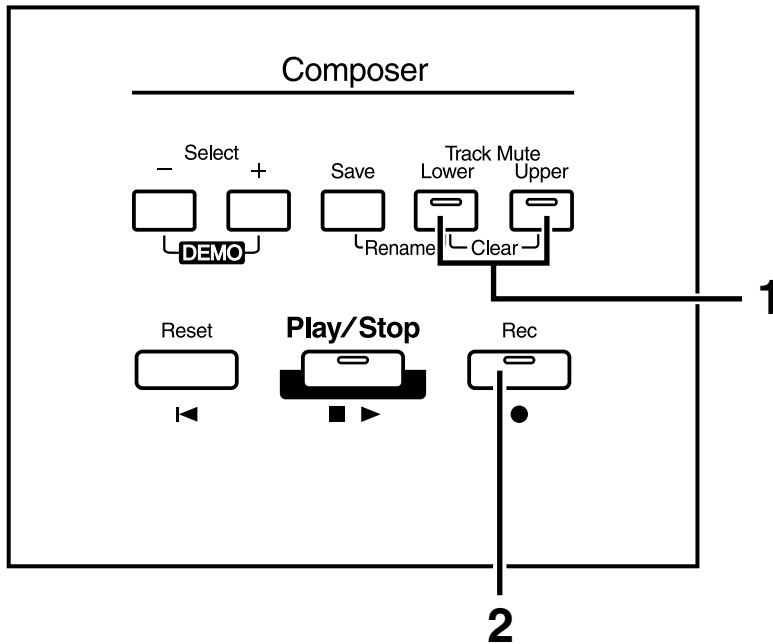

- 1. Press the Track Mute [Lower] and Track Mute [Upper] buttons simultaneously.**

The following message, asking you to confirm your choice, will be displayed.

```

Clear Song Sure?
Yes:REC No:RST
  
```

To cancel the procedure, press the [Reset] button.

- 2. If you are sure that you wish to erase the song, press the [Rec] button.**



## Record and Playback Your Performance

### Formatting Disks

Floppy disks must first be “formatted” (initialized) before they can be used by the AT-5 to store data. “Formatting” is the process of erasing any data which may have been on the disk and making the format of the floppy disk match the format of the device. The AT-5 cannot use a floppy disk that has a format differing from its own format.

#### NOTE

Formatting a disk will erase any data that may have been stored on it. Carefully check any previously used disk to be sure it doesn't contain any valuable data.

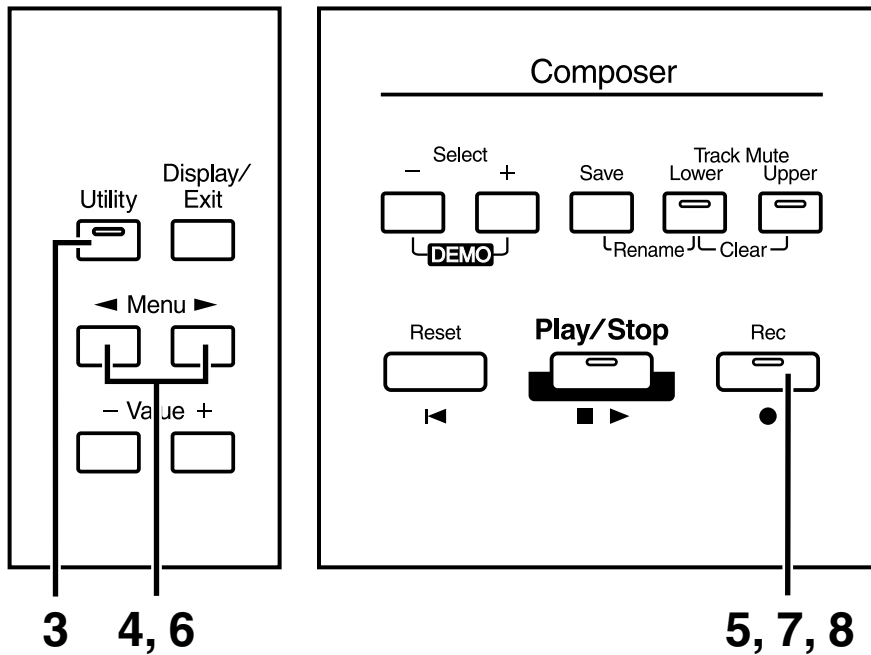

1. Make sure that the write protect tab of the floppy disk is in the “Write” (permit) position.

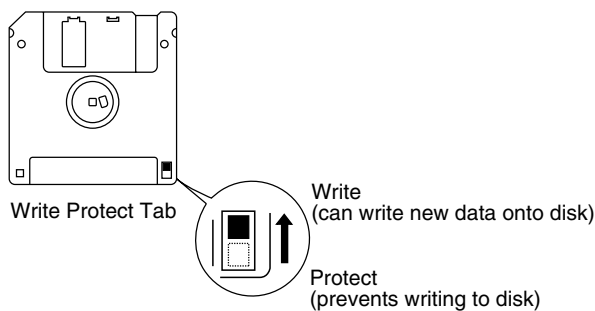

2. With the label of the floppy disk facing upward, insert it into the disk drive until it clicks into position.
3. Press the [Utility] button.



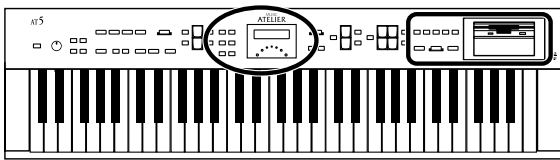

## Record and Playback Your Performance

- 4.** Press the Menu [ ◀ ] and [ ▶ ] buttons to select “Disk Utility.”

```
◄ Disk Utility ►  
Yes:REC
```

- 5.** Press the [Rec] button.

- 6.** Press the Menu [ ◀ ] and [ ▶ ] buttons to select “Format Disk.”

```
Format Disk ►  
Yes:REC No:RST
```

- 7.** Press the [Rec] button.

The following message, asking you to confirm, will be displayed.

```
Format Sure?  
Yes:REC No:RST
```

To cancel the procedure, press the [Reset] button.

- 8.** Press the [Rec] button again to perform the Format.

While formatting is in progress, the following display appears.

```
Formatting  
25% 00.....
```

When disk formatting is completed the following screen appears, then basic screen reappears.

```
Format Disk  
Completed.
```

### NOTE

Never attempt to remove the floppy disk until formatting is complete.

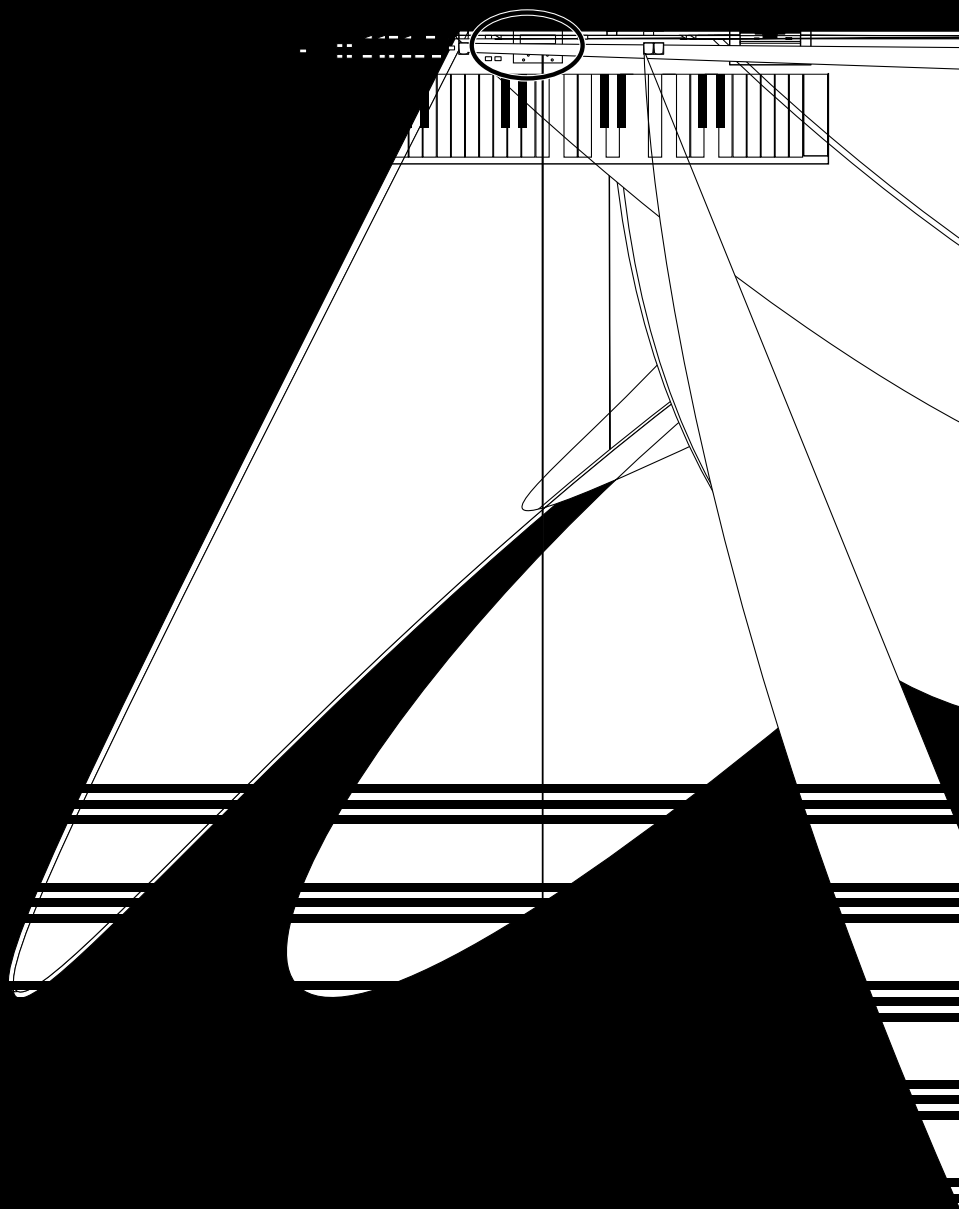

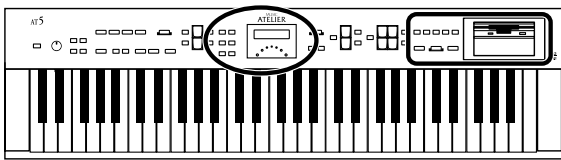

## Saving Performance Songs onto Floppy Disk

The performance data that you recorded will disappear when the power of the AT-5 is turned off. If you wish to keep the performance data, you can save it on a floppy disk.

If the performance data has never been saved to a floppy disk, a " " symbol appears in the display. When the performance data is saved to a floppy disk, this symbol will no longer be displayed.

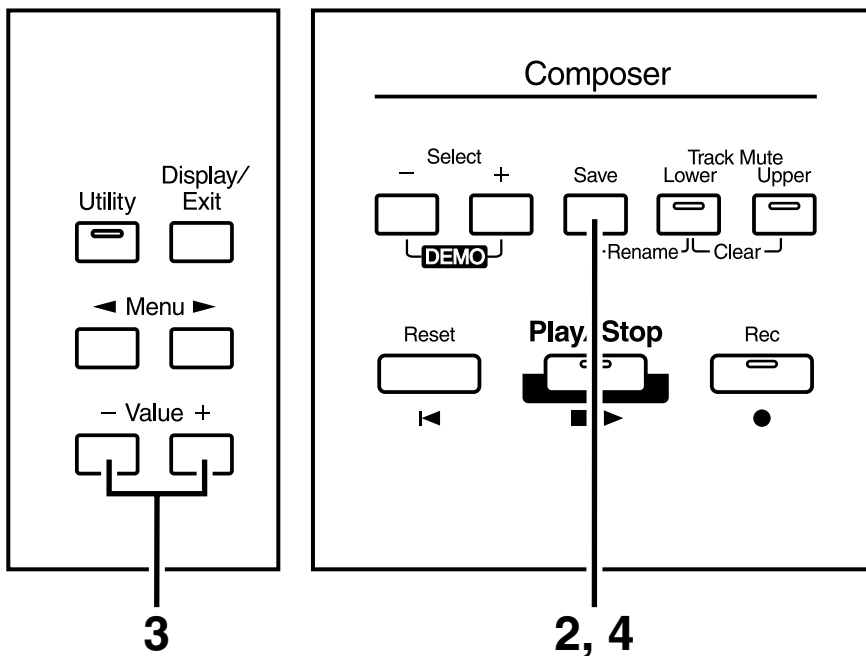
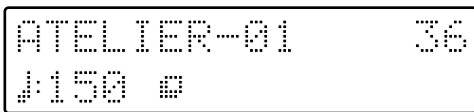

1. Insert a floppy disk formatted (p. 48) on the AT-5 into the disk drive.
2. Press the [Save] button.
3. Press the Value [-] and [+] button to select the format.

You can select either "ORIGINAL" or "SMF" format.

<b>ORIGINAL</b>	Save data in Atelier format
<b>SMF</b>	Saving in SMF Format for Atelier Sound Modules

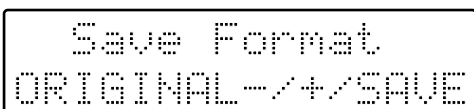

You can press the Select [-] [+] buttons to select the format for saving the data.



SMF (Standard MIDI File) is a data format that was created as a standardized way to exchange music data between devices made by different manufacturers.

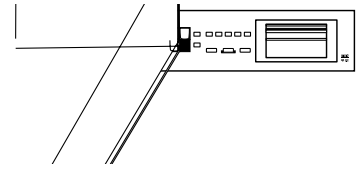

## Record and Playback Your Performance

### 4. Press the [Save] button to save the performance.

While performance data is being saved to the floppy disk, the following display appears.

```
ATELIER-01      36
Saving... ..
```

### ○ If the following screen will appear

If the floppy disk already contains performance data of the same name, the following display will appear.

```
Overwrite Song ?
Yes:REC No:RST
```

### ● If you wish to update the contents of the performance data

#### 1. Press the [Rec] button.

### ● If you wish to save the data without erasing the performance data already on floppy disk you must rename the song

#### 1. Press the [Reset] button to cancel saving.

#### 2. Change the name (p. 50), and perform the Save procedure once again.

#### NOTE

Music data that was saved in Atelier format cannot be played back correctly on instruments other than the Atelier series.

#### NOTE

Saving performance data in SMF format (SMF) requires a longer time than saving it in Atelier format (ORIGINAL).

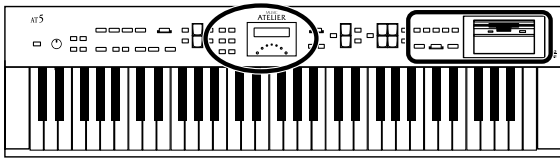

## Deleting Performance Songs Stored on Disk

Follow the steps below to erase a performance song that was saved onto a floppy disk.

- 1.** Insert the floppy disk containing performance songs into the disk drive.
- 2.** Press the [Utility] button.
- 3.** Press the Menu [◀] and [▶] buttons to select "Disk Utility."

```
◀ Disk Utility ▶  
Yes:REC
```

- 4.** Press the [Rec] button.
- 5.** Press the Menu [◀] and [▶] buttons to select "Delete Song."

```
◀ Delete Song  
Yes:REC No:RST
```

To cancel the procedure, press the [Reset] button.

- 6.** Press the [Rec] button.
- 7.** Using the Value [-] and [+] button, select the performance song to be erased.
- 8.** Press the [Rec] button.

You will see the following:

```
ATELIER-01  S01  
Del Sure?REC/RST
```

To cancel the procedure, press the [Reset] button.

- 9.** To delete the performance song, press the [Rec] button again.  
When erasing is completed, the basic screen reappears.

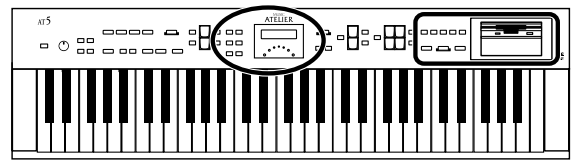

## Layering a New Recording onto SMF Music Files

You can load commercially available SMF music files into the AT-5, and record your own performance on top of it. During recording, the data you've loaded will be played back, while everything you play will be recorded.

- 1. Insert a floppy disk containing commercially available SMF music files into the floppy disk drive.**
- 2. Press the Select [-] [+] buttons to select the music file that you wish to load into the AT-5.**
- 3. Press the [Rec] button to enter record-ready mode.**

The selected music file will be loaded.

While performance data is being loaded, the following screen will appear.

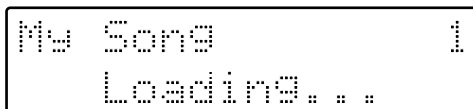

The [Rec] button indicator will light, and the [Play/Stop] button indicator will blink.

- 4. Make the panel settings that you wish to record.**
- 5. Press the [Play/Stop] button to begin recording.**

When you press the [Play/Stop] button, the metronome will play two measures (bars) of count-in before recording begins.

As you record, the music file that was loaded into the AT-5 will play back. Your own performance (on the upper and lower parts) will be recorded on top of the music files that you've loaded.

When the music files include performance data on Channel 1, Channel 3, or Channel 4, that performance data is deleted, and the performance on the upper part or lower part is recorded.

Part	AT-5 Track	Channel of the SMF
Lower	Lower	3
Upper	Upper	1, 4

- 6. Press the [Play/Stop] button to stop recording.**



The performance data you recorded can be saved on a floppy disk (p. 51).



Commercially sold music files can also be loaded into the AT-5, but for reasons of copyright protection, cannot be saved in SMF format.



You can re-record the bass performance. For details refer to "Re-recording the Bass Performance" (p. 60).



The performances of Channel 2 in SMF music files are deleted when bass performances are recorded over again.

---

## Re-recording a Performance Saved on Floppy Disk

---

A song saved on floppy disk can be loaded into the AT-5, and you can then re-record the performances.

- 1. Into the disk drive, insert the floppy disk that contains the performance data.**
- 2. Press the Select [-] [+] buttons to select the performance data that you wish to load into the AT-5.**
- 3. Press the [Rec] button to enter record-ready mode.**

The selected performance data will be loaded.  
The [Rec] button indicator will light, and the [Play/Stop] button indicator will blink.
- 4. Make the panel settings that you wish to record.**
- 5. Press the [Play/Stop] button to begin recording.**

When you press the [Play/Stop] button, the metronome will play two measures (bars) of count-in before recording begins.  
As you record, the performance data that was loaded into the AT-5 will play back.  
Your own performance (on the upper and lower parts) will be recorded on top of the performance data that you've loaded.  
If the loaded performance data contains upper part and/or lower part performances, that performance data will be erased and replaced by your new performance.
- 6. Press the [Play/Stop] button to stop recording.**

---

## Using Song with a Different Tempo Than That of the Performance Song

---

- 1. Into the disk drive, insert the floppy disk that contains the performance data.**
- 2. Press the Select [-] [+] buttons to select the performance data that you wish to change the tempo.**
- 3. Determine the tempo with the Tempo [ ] and [ ] buttons.**
- 4. Hold down the [Reset] button and press the [Rec] button.**

The song's tempo changes.



You can re-record the bass performance.  
For details refer to "Reals referee."

# Settings for the Composer

## Changing the Key When Playing Back Songs

SMF Music files or a performance that you recorded can be transposed for playback.

1. Press the [Utility] button.
2. Using the Menu [ ◀ ] and [ ▶ ] buttons, select "Play Transpose."

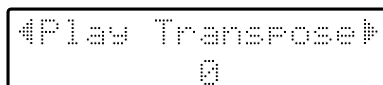

◀ Play Transpose ▶  
0

3. Press the Value [-] and [+] buttons to select the value for transpose.

Each press of the Value [-] and [+] buttons transpose the key by a semitone.

You can transpose the song within a range of -24 to +24 semitone.

To return to the basic screen, press the [Utility] button.

→ You can transpose the keyboard for performance. For details refer to "Transposing to a Different Key (Transpose Buttons)" (p. 36).

## Changing the Metronome Setting

This setting determines whether or not the metronome will sound.

1. Press the [Utility] button.
2. Using the Menu [ ◀ ] and [ ▶ ] buttons, select "Metronome."

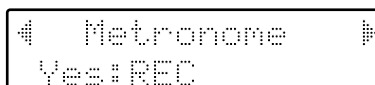

◀ Metronome ▶  
Yes: REC

3. Press the [Rec] button.
4. Using the Menu [ ◀ ] and [ ▶ ] buttons, select "Metronome."

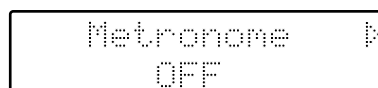

Metronome ▶  
OFF

5. Press the Value [-] and [+] buttons to select OFF, REC, or ON.

Setting	Descriptions
OFF	Not heard at all
REC	Heard only while recording
ON	Heard constantly

To return to the basic screen, press the [Utility] button.



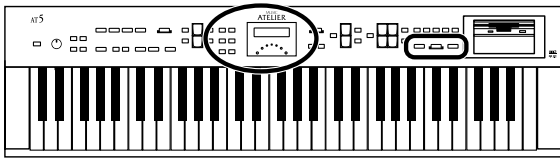

## Adjusting the Metronome Volume

You can adjust the volume of the metronome.

1. Press the [Utility] button.
2. Using the Menu [ ◀ ] and [ ▶ ] buttons, select "Metronome."

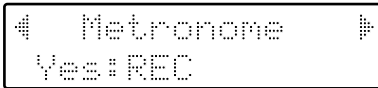

3. Press the [Rec] button.
4. Using the Menu [ ◀ ] and [ ▶ ] buttons, select "Metronome Vol." (Metronome Volume).

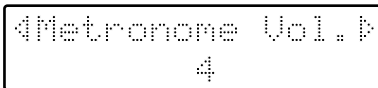

5. Press the Value [-] and [+] buttons to select the desired volume level (1–10).

Increasing the value will raise the volume of the metronome.

To return to the basic screen, press the [Utility] button.

## Changing the Sound of the Metronome

You can choose one of 4 different sounds for the metronome.

1. Press the [Utility] button.
2. Using the Menu [ ◀ ] and [ ▶ ] buttons, select "Metronome."

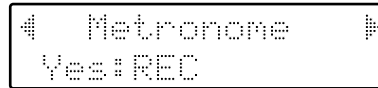

3. Press the [Rec] button.
4. Press the Menu [ ◀ ] and [ ▶ ] buttons to select "Metronome Sound."

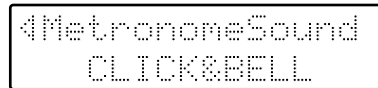

5. Press the Value [-] and [+] buttons to select the type of sound for the metronome.

Setting	Descriptions
CLICK&BELL	Conventional metronome sound
ELECTRONIC	Electronic metronome sound
VOICE ENG.	Human voice (English)
VOICE JPN.	Human voice (Japanese)

To return to the basic screen, press the [Utility] button.

→ This setting remains stored in memory even while power is turned off.

## Settings for the Composer

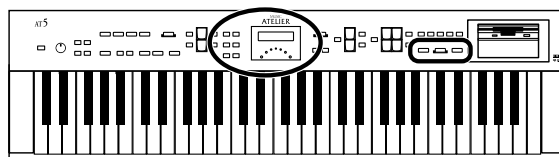

### Setting the Beat

This setting determines the beat to be used when recording performance songs.

1. Press the [Utility] button.
2. Using the Menu [◀] and [▶] buttons, select "Beat."

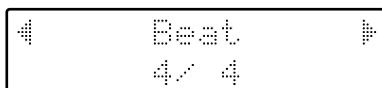

3. Press the Value [-] and [+] buttons to set the beat.

Setting      2/2, 0/4, 2/4, 3/4, 4/4, 5/4, 6/4, 7/4, 3/8, 6/8,  
                  9/8, 12/8

To return to the basic screen, press the [Utility] button.

- \* When recording your performance with playing Rhythm performances or Automatic Accompaniment, the beat is set automatically.
- \* You cannot change the beat of previously recorded songs.

### Silencing a Specific Track

You can temporarily silence sound of a specific track. This is referred to as "Track Mute."

1. Press the [Utility] button.
2. Using the Menu [◀] and [▶] buttons, select "Tr. Mute" (Track Mute).
3. Press the Value [-] and [+] buttons to select the track that you wish to mute.

From the left, these are "R (rhythm), A (accompaniment), B (bass), L (lower), U (upper) and C (control)."

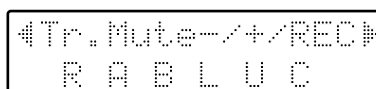

#### What is a Track?

The AT-5's Composer features six tracks. The following types of performance are recorded to the tracks.

<b>R</b> (Rhythm)	Rhythm performances, Drums/SFX
<b>A</b> (Accomp)	Automatic Accompaniment (except Bass)
<b>B</b> (Bass)	Bass voice, Bass part of the Automatic Accompaniment
<b>L</b> (Lower)	Lower voice
<b>U</b> (Upper)	Upper voice
<b>C</b> (Control)	Panel operations, Expression Pedal operations

4. Press the [Rec] button.

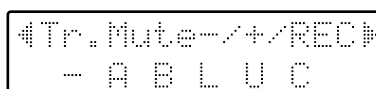

The character changes to "-", indicating that the track is muted.

5. Once again press the [Rec] button, and muting will be canceled.

To return to the basic screen, press the [Utility] button.

### Assigning Component Tracks

Track
R (Rhythm)
A (Accomp)
B (Bass)
L (Lower)
U (Upper)

During operation

P

N  
v

*Channel mute will be defeated when you perform the following operations.*

Press the Select [-] and [+] buttons to select different performance data.

## Settings for the Composer

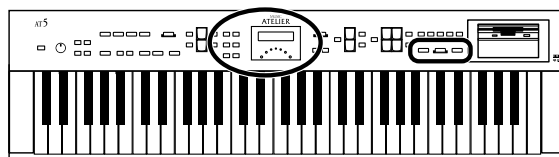

### Re-recording the Bass Performance

You can erase the bass accompaniment of SMF music files and record your own bass performance, or re-record the bass performance of a song that was previously saved on disk.

1. Press the [Utility] button.
2. Press the Menu [◀] and [▶] buttons to select "BassReplaceRec."

```
◀BassReplaceRec▶
      OFF
```

3. Press the Value [-] and [+] buttons to switch the Bass Replace Rec "ON" or "OFF."

Setting	Descriptions
OFF	The bass performance will not be recorded.
ON	The bass performance will be recorded.

4. Press the [Utility] button.  
The Basic screen will reappear.
5. Re-record the performance (p. 23, p. 46, p. 54, p. 55).

### Changing the Function of the Expression Pedal

Specify how the Expression Pedal will function when your performance is being recorded and when ATELIER song files are being played back.

#### ■ Function During Recording

Specify whether Expression Pedal operations will be recorded or not while your performance is being recorded.

1. Press the [Utility] button.
2. Press the Menu [◀] and [▶] buttons to select "Exp. Source."

```
◀ Exp. Source ▶
      Yes:REC
```

3. Press the [Rec] button.
4. Press the Menu [◀] and [▶] buttons to select "Recording."
5. Press the Value [-] and [+] buttons to specify the pedal function.

```
Recording ▶
      PEDAL
```

Setting	Descriptions
PEDAL	Expression Pedal movements will be recorded. The previous recording will be erased as new songs are recorded.
COMPOSER	Expression Pedal movements will not be recorded. The previous data will remain without being erased.

To return to the basic screen, press the [Utility] button.

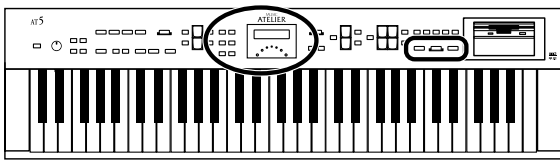

### ■ Function During Playback

You can specify whether or not the Expression pedal will function while ATELIER song files are being played back.

1. Press the [Utility] button.
2. Press the Menu [ ◀ ] and [ ▶ ] buttons to select "Exp. Source."

```
◀ Exp. Source ▶
Yes+REC
```

3. Press the [Rec] button.
4. Press the Menu [ ◀ ] and [ ▶ ] buttons to select "Playback."
5. Press the Value [-] and [+] buttons to specify the pedal function.

```
◀ Playback
PEDAL+COMPOSER
```

Setting	Descriptions
<b>PEDAL+ COMPOSER</b>	Expression pedal will function. Expression pedal recording within the song file will also be effective.
<b>COMPOSER</b>	Expression pedal will not function. The Expression pedal recording within the song file will be effective.
<b>PEDAL</b>	Expression pedal will function. The Expression Pedal recording within the song file will be ignored.

To return to the basic screen, press the [Utility] button.

### Switching the Display of Lyrics On or Off

Some music files have Lyrics included and these Lyrics can be displayed on the screen. You can turn on or off the lyrics display of such music files.

1. Press the [Utility] button.
2. Press the Menu [ ◀ ] and [ ▶ ] buttons to select "Lyric."

```
◀ Lyric ▶
ON
```

3. Press the Value [-] and [+] buttons to switch the lyric display "ON (displayed)" or "OFF (not displayed)."

To return to the basic screen, press the [Utility] button.

\* If you press a voice select button while playing back music files that contains lyrics, the display screen will switch, and the lyrics will no longer be displayed. To re-display the lyrics, press the [Rec] button.

→ This setting remains stored in memory even while power is turned off.

# Adjusting the Effects

## Sustain Effect

Sustain allows you to add a decay to each voice after the keys are released.

1. Press the [Utility] button.
2. Press the Menu [ ◀ ] and [ ▶ ] buttons to select "Sustain."

```
◀ Sustain ▶  
Yes:REC
```

3. Press the [Rec] button.
4. Press the Menu [ ◀ ] and [ ▶ ] buttons to select "Sustain."

```
Sustain ▶  
Upper : OFF
```

5. Press the Menu [ ◀ ] and [ ▶ ] buttons to select the keyboard register to which the sustain effect is to be applied.

Register    **Upper, Lower**

6. Press the Value [-] and [+] buttons to adjust the setting.

Setting	Descriptions
ON	The Sustain effect is applied to the voices
OFF	The Sustain effect is not applied to the voices

To return to the basic screen, press the [Utility] button.

## Changing the Sustain Length

You can change the length of the sustain in each register.

1. Press the [Utility] button.
2. Press the Menu [ ◀ ] and [ ▶ ] buttons to select "Sustain."

```
◀ Sustain ▶  
Yes:REC
```

3. Press the [Rec] button.
4. Press the Menu [ ◀ ] and [ ▶ ] buttons to select "Sustain Length."

```
◀Sustain Length▶  
Upper : LONG
```

5. Press the Menu [ ◀ ] and [ ▶ ] buttons to select the keyboard register whose sustain length you wish to adjust.

Register    **Upper, Lower**

6. Press the Value [-] and [+] buttons to adjust the setting.

Settings    **SHORT, MIDDLE, LONG**

To return to the basic screen, press the [Utility] button.

# Various Other Settings

## Turning Initial Touch On/Off (Initial Touch)

Initial Touch is a function that translates the force used in playing the keys into a directly proportional amount of volume. It can be switched ON/OFF independently for the Upper and Lower registers.

1. Press the [Utility] button.
2. Press the Menu [◀] and [▶] buttons to select "Initial Touch."

```
◀Initial Touch ▶
  Upper :  ON
```

3. Press the Menu [◀] and [▶] buttons to select "Initial Touch Upper," or "Initial Touch Lower."  
Register    Upper, Lower
4. Press the Value [-] and [+] buttons to switch the Initial Touch "ON" or "OFF."

Setting	Descriptions
ON	The harder you play the key, the higher the volume. Some voices switches the sound depending on the strength with which you play the keyboard.
OFF	Volume remains constant regardless of how hard you play. The way the sounds are played also remains unchanged.

To return to the basic screen, press the [Utility] button.

→ This setting remains stored in memory even while the power is turned off.

## Changing the Function of the Foot Switch (Left Foot Sw, Right Foot Sw)

On each side of the expression pedal is a foot switch, and a function is assigned to each switch.

You can select any of the following functions and assign them to Foot Switch.

1. Press the [Utility] button.
2. Press the Menu [◀] and [▶] buttons to select "Left Foot Sw" or "Right Foot Sw."

```
◀ Left Foot Sw ▶
      GLIDE
```

```
◀Right Foot Sw ▶
ROTARY FAST/SLOW
```

3. Press the Value [-] and [+] buttons to set the function to be assigned to the foot switch.

Setting	Descriptions
ROTARY FAST/SLOW	Switch the Rotary speed between "FAST" and "SLOW."
GLIDE	While the Foot Switch is pressed, the pitch will temporarily be lowered, and will gradually return to normal when you release the Foot Switch.
DAMPER OF UPPER	Notes played on the Upper part of the keyboard will be sustained only while you continue pressing the Foot Switch.

To return to the basic screen, press the [Utility] button.

## Various Other Settings

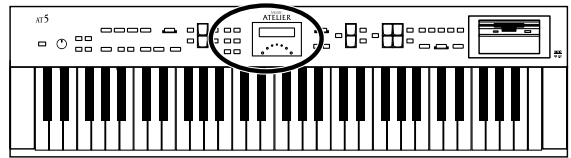

### Preventing Rhythm Tempos from Switching Automatically (Auto Standard Tempo)

You can prevent rhythm tempos from switching automatically when you switch rhythms.

1. Press the [Utility] button.
2. Press the Menu [◀] and [▶] buttons to select "AutoStdTempo" (Auto Standard Tempo).

```
◀ AutoStdTempo ▶
      ON
```

3. Press the Value [-] and [+] buttons to switch the Auto Standard Tempo "ON" or "OFF."

Setting	Descriptions
ON	Switching the rhythm while the rhythm is stopped automatically changes the tempo settings to those in the new rhythm.
OFF	When the rhythm is stopped, the tempo settings are not changed automatically when the rhythms are changed.

To return to the basic screen, press the [Utility] button.

→ This setting remains stored in memory even while power is turned off.

### Playing a Count Sound When the Intro Ends (Intro Count Down)

If an intro is played before your performance, you can have a countdown played to the end of the intro, allowing you to understand easily where you are to start playing.

1. Press the [Utility] button.
2. Using the Menu [◀] and [▶] buttons, select "IntroCountDown."

```
◀ IntroCountDown ▶
      OFF
```

3. Press the Value [-] [+] buttons to switch the Intro Count Down "ON" or "OFF."

Setting	Descriptions
ON	When you press the [Intro/Ending] button, an intro will play, and the end of the intro will be counted-down.
OFF	The count sound does not play.

To return to the basic screen, press the [Utility] button.

### Changing the Sound of the Count Down (Count Down Sound)

You can change the sound that is used for the count played at the end of the intro.

1. Press the [Utility] button.
2. Press the Menu [◀] and [▶] buttons to select "CountDownSound."

```
◀ CountDownSound ▶
      VOICE
```

3. Press the Value [-] and [+] buttons to select the type of sound for Intro Count Down.

Setting	Descriptions
VOICE	Human voice count (One, two, three...)
STICK	Stick sound count

To return to the basic screen, press the [Utility] button.



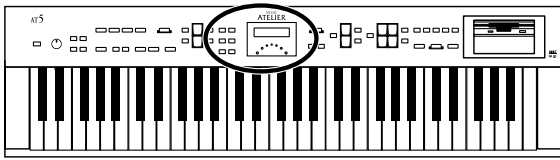

## Adjust the Standard Pitch (Master Tune)

The basic pitch of an instrument is generally considered as the pitch of the middle A note. The “Master Tune” parameter lets you adjust this basic pitch to match the pitch of any other instruments that are playing together with the AT-5.

1. Press the [Utility] button.
2. Press the Menu [ ◀ ] and [ ▶ ] buttons to select “Master Tune.”



3. Press the Value [-] and [+] buttons to adjust the basic pitch.  
Settings **415.3Hz – 466.2Hz (0.1 Hz units)**

To return to the basic screen, press the [Utility] button.

- By pressing the Value [+] and [-] buttons simultaneously, you can restore the default setting (440.0 Hz).
- This setting remains stored in memory even while power is turned off.

## Selecting the MIDI Transmit Channel (Tx MIDI Channel)

You can use the MIDI connectors of the AT-5 to transmit musical data to external devices. This setting determines which channel is used to transmit the MIDI messages that provide detailed information about what is being played on the keyboard.

→ For details refer to “If You’re Using MIDI” (p. 67).

1. Press the [Utility] button.
2. Press the Menu [ ◀ ] and [ ▶ ] buttons to select “MIDI.”

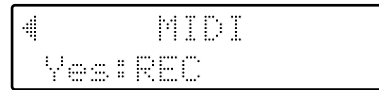

3. Press the [Rec] button.
4. Press the Menu [ ◀ ] and [ ▶ ] buttons to select “TxMIDI Channel.”

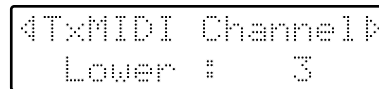

5. Press the Menu [ ◀ ] and [ ▶ ] buttons to select a part.  
Part **Upper, Lower, Control**
6. Press the Value [-] and [+] buttons to select the MIDI transmission channel.  
Channel **1-16**

To return to the basic screen, press the [Utility] button.

\* The CONTROL part transmits expression pedal data.

# Connecting with External Devices

If you want to hook up an external instrument to the AT-5, then this chapter is for you.

## Names and Functions of Jacks and Connectors

### 1 MIDI Out/In Connectors

You can connect external MIDI instruments to these connectors to exchange performance information.

### 2 Damper Pedal Jacks

You can connect a damper pedal (sold separately) and use it to produce a lingering effect for the notes you play on the keyboard.

### 3 Input L (mono)/R Jacks

Using this jack, you can connect other sound generating devices or audio equipment and play sounds from other devices through the AT-5's speaker.

### 4 Output L (mono)/R Jacks

You can some awesome sounds if you connect speakers or other audio equipment to these jacks. You can also hook up a cassette recorder to record your performances.

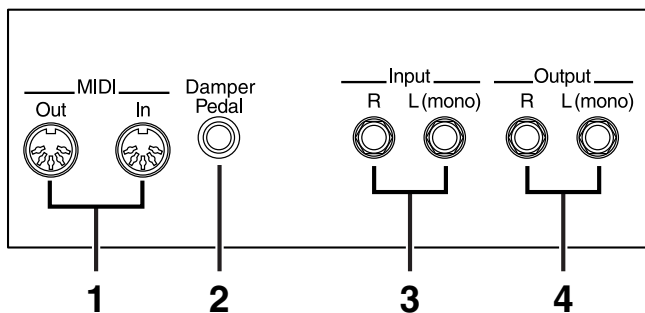

## Connecting Audio Equipment

### Output Jack

You can connect audio equipment using audio cables (sold separately) and play the sounds from the AT-5 through the speakers on the connected equipment or record your performances on a tape recorder or other recording device. If the output of the connected device is monaural, you must use the L (Mono) jack.

Use an audio cable to connect the input jack on the audio set or amp mixer to one of the output jacks on the AT-5. Use an audio cable with a standard plug. When purchasing an audio cable, please consult the vendor where you bought the AT-5.

### Input Jack

You can connect another sound module, such as audio equipment or an electronic instrument using audio cables (sold separately) and play the sounds from the connected device through the speakers on the AT-5.

If the input of the connected device is monaural, you must use the L (Mono) jack.

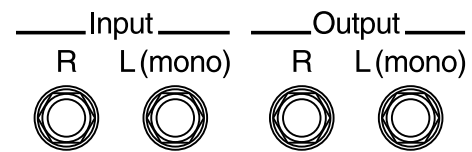

## ■ Making the Connections

### NOTE

To prevent malfunction and/or damage to speakers or other devices, always turn down the volume, and turn off the power on all devices before making any connections.

1. Turn down the volume all the way on all equipment.
  2. Turn off the power to the AT-5 and other connected equipment.
  3. Connect the AT-5 and other equipment with audio cables (sold separately).
  4. Turn on the connected equipment.
  5. Turn on the AT-5.
  6. Adjust the volume.
- After use, follow the steps below to switch off the power.
1. Turn down the volume all the way on all equipment.
  2. Turn off the AT-5.
  3. Turn off the connected equipment.

### If You're Using MIDI

#### ● What's MIDI?

MIDI stands for "Musical Instrument Digital Interface," and is a unified standard for the exchange of performance data and other information between electronic instruments and computers.

The AT-5 is equipped with MIDI connectors to let it exchange performance information with external devices. These connectors can be used to connect the AT-5 to an external device for even greater versatility.

#### ● About MIDI Connectors

The AT-5 has two kinds of MIDI connectors.

Connecting these to the MIDI connectors on a MIDI instrument makes it possible for the two instruments to control each other.

For instance, you can output sound from the other instrument or switch tones on the other instrument.



You should also set the MIDI send channel as needed (p. 65).

#### ○ MIDI Out Connector

Data describing what's played on the keyboard and all movements of the damper pedal, as well as expression data is transmitted to the external MIDI connector.

#### ○ MIDI In Connector

Performance messages from an external MIDI device are received here.

These incoming messages may instruct the receiving MIDI instrument to play sounds or switch tones.

### ■ Connecting the AT-5 to a MIDI Instrument

#### NOTE

To prevent malfunction and/or damage to speakers or other devices, always turn down the volume, and turn off the power on all devices before making any connections.

1. Turn down the volume all the way on all equipment.
2. Turn off the power to the AT-5 and other connected equipment.
3. Use a MIDI cable (sold separately) to connect the MIDI connector on the external instrument to the MIDI connector on the AT-5.
4. Turn on the external MIDI device and AT-5.
5. You should change the setting of TxMIDI channel as needed (p. 65).

#### Connection Example:

- Connecting the MIDI Device

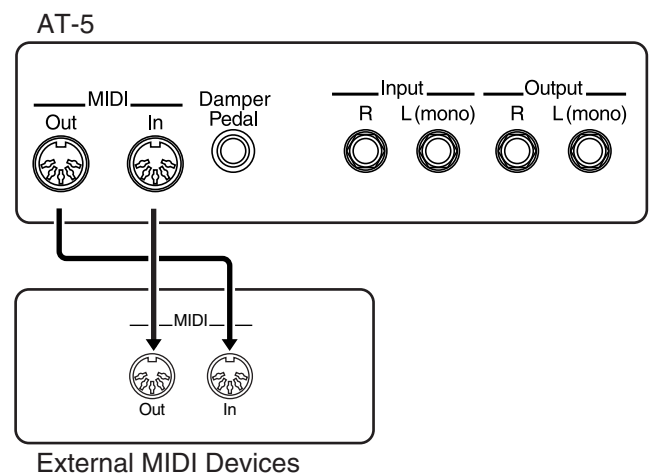

\* A separate publication titled "MIDI Implementation" is also available. It provides complete details concerning the way MIDI has been implemented on this unit. If you should require this publication (such as when you intend to carry out byte-level programming), please contact the nearest Roland Service Center or authorized Roland distributor.

# Troubleshooting

If the AT-5 does not function in the way you expect, first check the following chart. If this does not resolve the problem, consult your dealer or a nearby Roland Service Station.

## **When you press the [Power On] switch, the power doesn't come on**

- Power cord is not connected correctly (p. 15).

## **No sound is heard**

- The [Master Volume] knob is set too low (p. 15).
- Headphones are connected (p. 15).  
When you connect the headphones, the sound is heard only through the headphones.
- The volume of each Part Balance button is set too low (p. 24).
- The volume is set too low on the Expression Pedal (p. 37).
- You do not have a voice selected (p. 19).  
Voices that have their button indicator lit can be played.

## **No sound is heard (when a MIDI instrument is connected)**

- The power of the connected external devices is not turned on (p. 66).

## **Expression Pedal does not operate**

- The function of the Expression Pedal during recording (p. 60) or the function during playback (p. 61) has been set to "COMPOSER."

## **Pressing the expression pedal while playing back Atelier performance data produces a crackling noise**

- Is the expression pedal function (p. 61) set to "PEDAL+COMPOSER" during playback of Atelier performance data?  
When this setting is used, moving the expression pedal while playing back Atelier performance data may create a difference between the expression pedal information in the performance data and the volume as set with the expression pedal, which can result in this kind of sound being produced.  
Set the expression pedal function (p. 61) to "PEDAL" during playback.

## **Rotary effect is not be applied**

- Some sounds do not allow the rotary effect to be applied (see the Leaflet of the AT-5 Specifications).

## **Even though you press only one key, a multiple number of notes sound**

- Harmony Intelligence is at ON (p. 31).
- Chord Intelligence is turned ON (p. 23, p. 30).

## **Automatic Accompaniment sounds odd**

- The keys for a chord were not pressed simultaneously.

## **Pitch is off**

- Transpose is in effect (p. 36).
- The tuning is incorrect (p. 65).
- While set for an octave shift (p. 25), you are playing keys beyond the recommended range. This does not indicate a malfunction.

## **Performance data cannot be played back**

- While the Utility menu appears in the display (with the exception of Channel Mute and Track Mute), playback is not allowed. If you wish to playback performance data, press the [Utility] button once again to exit the Utility menu (p. 56–p. 65).

## **Recording is not possible**

- While the Utility menu appears in the display, recording is not allowed. If you wish to record performance data, press the [Utility] button once again to exit the Utility menu (p. 56–p. 65).

## **Lyrics are not indicated properly in the display**

- With some music files, the lyrics cannot be displayed correctly.
- If you press a button while the lyrics are being shown in the display, the lyrics will disappear. To recall them, press the [Rec] button.

## **The recorded performance has disappeared**

- Any performance that has been recorded is deleted when the power of the unit is turned off. A performance cannot be restored once it's been deleted, so be sure to save it on a floppy disk before you turn off the power (p. 51).

## **The bass note of the Automatic Accompaniment does not sound**

- When the [Bass To Lower] button is on (lit), the bass of the Automatic Accompaniment will not sound.

## **Sound is distorted / cracked**

- The Part Balance volume of each part is too high (p. 24).
- The Reverb volume has been raised when the volume of each Part Balance button is already raised.  
Either lower the Reverb volume, or adjust the Part Balance of each part (p. 24).
- The [Master Volume] knob has been used to raise the overall volume excessively (p. 15).

## **Some keys (of certain keyboard parts) sound strange**

- You've assigned the same voice, using the same range, to multiple parts.

### **When play the lower part of the keyboard, the bass voice is heard**

- The [Bass To Lower] button (p. 23) is pressed.
- When the [Bass To Lower] button is switched on (lit), the bass voice is played as the root of chords played in the Lower part.

### **Bass voice not playing**

- The [Bass To Lower] button's indicator is unlit.  
Press the [Bass To Lower] button so its indicator is lighted.

### **When playing the same sound in the Upper part and Lower part, the volume is different**

- On one of the parts, "Initial Touch" is turned ON (p. 63).
- The volume levels of the parts are different.  
Adjust the volume balance of each part (p. 24).

### **Lower part of the keyboard cannot be heard**

- The Lower part will not produce sound while an Intro or Ending is being played.

### **The sound is not played correctly**

- If you layer the same type of sound, or play an octave-shifted organ sound, the timing at which you play a note or the phase relationship between the two sounds may affect the way in which the sounds are heard, but this is not a malfunction.

### **Can't play the demo songs**

- A floppy disk is inserted in the disk drive.  
In order to play the demo song, you must remove the floppy disk from the disk drive (p. 41).

### **The volume level of the instrument connected to AT-5 is too low**

- Could you be using a connection cable that contains a resistor?  
Use a connection cable that does not contain a resistor.

# Display Messages

Copy Protected.  
Can't Save

## Meanings:

- To protect the copyright, this music file cannot be saved as SMF format.
- When you want to save as Atelier format, you can save on a floppy disk.

Can't Save  
This Song.

## Meanings:

- You can only play the music data. It cannot be saved on a floppy disk or internal memory.

Write-Protected  
Disk

## Meanings:

- The protect tab on the floppy disk is set to the Protect position. Change it to the Write position and repeat the procedure.

Master Disk

## Meanings:

- This floppy disk cannot store the format or save any data. Insert a different floppy disk and repeat the procedure.

Read Only Song.  
Can't Save

## Meanings:

- You cannot save data by overwriting the song on the floppy disk.

No Disk

## Meanings:

- No floppy disk is inserted to the disk drive. Insert the floppy disk correctly, and repeat the procedure.

Disk Full

## Meanings:

- There is not sufficient space left on the floppy disk for the data to be saved. Prepare another floppy disk that has been formatted on this instrument.

Unknown Disk

## Meanings:

- The floppy disk inserted into the disk drive cannot be read. Please format the floppy disk.

Disk Ejected

## Meanings:

- The floppy disk was removed from the disk drive while loading or writing was in progress. Insert a floppy disk and repeat the procedure.

Damaged Disk

## Meanings:

- This floppy disk is damaged and cannot be used. Insert a different floppy disk and repeat the procedure.

Can't Read

## Meanings:

- This song cannot be read.

Can't Play

## Meanings:

- It cannot be read the floppy disk quickly enough. Press the [Reset] button, then press the [Play/Stop] button to play the song.

Memory Full

Meanings:

- The performance data is excessively large, and cannot be loaded.
- Since the internal memory is full, recording is not possible.

MIDI Buffer Full

Meanings:

- The AT-5 cannot deal with the excessive MIDI data sent from the external MIDI device. Reduce the amount of MIDI data sent to the AT-5.

Communication  
Error

Meanings:

- A MIDI cable has been disconnected. Connect it properly and securely.

Memory Error

Meanings:

- There is something wrong with the system. Repeat the procedure from the beginning.

Internal Memory  
Near Limit

Meanings:

- The AT-5 is warning you that its memory will soon become full to capacity, so not much more recording can be done.

Clear Song Sure?  
Yes:REC No:RST

Meanings:

- To carry out the procedure, you first need to erase performance data in the AT-5. This message asks you to confirm that you don't mind doing this.  
To erase the data, press the [Rec] button. When you do not want to erase it, press the [Reset] button then save the data on floppy disk.

Overwrite Song ?  
Yes:REC No:RST

Meanings:

- There already is performance data having the same name on the floppy disk.  
To replace the existing data with the new version, press the [Rec] button. To save it as a separate new file, press the [Reset] button first. Then, after changing the name, save it on floppy disk.

# Chord List

● symbol : Indicates the constituent note of chords.

★ symbol : Chord shown with an "★" can be played by pressing just the key marked with the "★" (when Chord Intelligence is ON).

C	C#	D	E $\flat$	E	F
Cmaj7	C#maj7	Dmaj7	E $\flat$ maj7	Emaj7	Fmaj7
C7	C#7	D7	E $\flat$ 7	E7	F7
Cm	C#m	Dm	E $\flat$ m	Em	Fm
Cm7	C#m7	Dm7	E $\flat$ m7	Em7	Fm7
Cdim	C#dim	Ddim	E $\flat$ dim	Edim	Fdim
Cm7 $\flat$ 5	C#m7 $\flat$ 5	Dm7 $\flat$ 5	E $\flat$ m7 $\flat$ 5	Em7 $\flat$ 5	Fm7 $\flat$ 5
Caug	C#aug	Daug	E $\flat$ aug	Eaug	Faug
Csus4	C#sus4	Dsus4	E $\flat$ sus4	Esus4	Fsus4
C7sus4	C#7sus4	D7sus4	E $\flat$ 7sus4	E7sus4	F7sus4
C6	C#6	D6	E $\flat$ 6	E6	F6
Cm6	C#m6	Dm6	E $\flat$ m6	Em6	Fm6



F#	G	A $\flat$	A	B $\flat$	B
F#maj7	Gmaj7	A $\flat$ maj7	A maj7	B $\flat$ maj7	B maj7
F#7	G7	A $\flat$ 7	A7	B $\flat$ 7	B7
F#m	Gm	A $\flat$ m	Am	B $\flat$ m	Bm
F#m7	Gm7	A $\flat$ m7	Am7	B $\flat$ m7	Bm7
F#dim	Gdim	A $\flat$ dim	Adim	B $\flat$ dim	Bdim
F#m7 $\flat$ 5	Gm7 $\flat$ 5	A $\flat$ m7 $\flat$ 5	Am7 $\flat$ 5	B $\flat$ m7 $\flat$ 5	Bm7 $\flat$ 5
F#aug	Gaug	A $\flat$ aug	A aug	B $\flat$ aug	Baug
F#sus4	Gsus4	A $\flat$ sus4	Asus4	B $\flat$ sus4	Bsus4
F#7sus4	G7sus4	A $\flat$ 7sus4	A7sus4	B $\flat$ 7sus4	B7sus4
F#6	G6	A $\flat$ 6	A6	B $\flat$ 6	B6
F#m6	Gm6	A $\flat$ m6	Am6	B $\flat$ m6	Bm6

# Glossary

## Arrangement

This refers to changes that have been made in an original tune, by adding a new accompaniment or by changing the instruments used.

## Automatic Accompaniment

Accompaniment is played automatically in response to the chords played in the keyboard's Lower part.

## Basic Chord

This refers to the most commonly used types of chord, which are generally the following six types: major chords, minor chords, minor seventh chords, minor seventh ( $\flat 5$ ) chords, dominant seventh chords, and diminished seventh chords.

## Chord

Notes of two or more pitches sounded simultaneously. Chords consisting of three notes are called "triads," and are the most basic type of chord.

## Ending

This is the last part of the accompaniment. When you stop playing the Automatic Accompaniment, the AT-5 plays an Ending appropriate for the Rhythm.

## Glide

An effect that temporarily lowers the pitch and then gradually returns it to normal.

## Intro

This is the introductory portion of an Automatic Accompaniment performance. The AT-5 plays an intro ideally suited to each Rhythm when it starts playing the Automatic Accompaniment.

## Inversion

When the lowest note of a chord is the root, the chord is said to be in "root position." In contrast, forms of a chord in which other notes are the lowest pitch are called "inversions."

## Mute

To silence a sound. The AT-5 provides a Track Mute function that allows you to turn off the Track Mute button indicator of a track on which music data has been recorded, so that the corresponding track will temporarily be silenced.

## Panel Settings

Settings such as sound selections, tempo, Rotary fast/slow.

## Reverb

An effect that simulates the reverberation of a concert hall.

## Root Note

The root note is the basis of a chord. All chords are built on a root note, which is the part of the chord name given in uppercase letters.

## Rotary

An effect which simulates the modulation given to the sound when a rotating speaker is used. The Rotary effect produces two types of modulation: fast or slow.

## Sustain

An effect that adds a decay to each note. The AT-5 allows sustain to be applied to the voices of the upper part and lower part.

## Voice

The AT-5 is able to produce the sounds of various instruments. These sounds are called "Voices."

## About ATELIER Series Sound Generator

The ATELIER series come equipped with GM2/GS sound generators.

### General MIDI 2

The General MIDI 2 is a set of recommended specifications that provide detailed definitions for functionality such as sound editing and effects that had not been defined in the General MIDI, and extend the sound map to allow a higher degree of performance expression and compatibility. Since the General MIDI 2 is compatible with the General MIDI, it is capable of reliably playing back music files bearing the General MIDI logo.

### General MIDI

The General MIDI is a set of recommendations which seeks to provide a way to go beyond the limitations of proprietary designs, and standardize the MIDI capabilities of sound generating devices. Sound generating devices and music files that meets the General MIDI standard bears the General MIDI logo. Music files bearing the General MIDI logo can be played back using any General MIDI sound generating unit to produce essentially the same musical performance.

### GS format

The GS Format is Roland's set of specifications for standardizing the performance of sound generating devices. In addition to including support for everything defined by the General MIDI, the highly compatible GS Format additionally offers an expanded number of sounds, provides for the editing of sounds, and spells out many details for a wide range of extra features, including effects such as reverb and chorus.

Designed with the future in mind, the GS Format can readily include new sounds and support new hardware features when they arrive.

Since it is upwardly compatible with the General MIDI, Roland's GS Format is capable of reliably playing back GM Scores equally as well as it performs GS music files (music files that have been created with the GS Format in mind). This product supports both the General MIDI and the GS Format, and can be used to play back music data carrying either of these logos.

### SMF with Lyrics

"SMF with Lyrics" refers to SMF (Standard MIDI File) that contains the lyrics. When music files carrying the "SMF with Lyrics" logo are played back on a compatible device (one bearing the same logo), the lyrics appears in its display.

### XG lite

XG is a tone generator format of YAMAHA Corporation, that defines the ways in which voices are expanded or edited and the structure and type of effects, in addition to the General MIDI 1 specification. XG lite is a simplified version of XG tone generation format. You can play back any XG music files using an XG lite tone generator. However, keep in mind that some music files may play back differently compared to the original files, due to the reduced set of control parameters and effects.

# MIDI Implementation Chart

Function...		Transmitted	Recognized	Remarks
Basic Channel	Default	2 (Bass) 3 (Lower) 4 (Upper) 16 (Expression, PC)	1-16 (GM2/GS)	
	Changed	1-16 *6	X	
Mode	Default Messages Altered	x x *****	Mode 3 *3, 4 Mode 3, 4(M=1)	
Note Number :	True Voice	32-103 *****	0-127 0-127	
Velocity	Note ON Note OFF	O *1 x 8n v=64	O x	
After Touch	Key's Ch's	x x	O *2, 4 O *2, 3, 4, 5	
Pitch Bend		x	O *2, 3, 4, 5	
Control Change	0, 32	O *1	O *3, 4	Bank select
	1	x	O *2, 3, 4, 5	Modulation
	5	x	O *2, 3, 4	Portamento time
	6, 38	x	O *2, 3, 4, 5	Data entry
	7	x	O *2, 3, 4, 5	Volume
	10	x	O *3, 4, 5	Panpot
	11	O	O *3, 4, 5	Expression
	64	O	O *3, 4, 5	Hold 1
	65	x	O *3, 4	Portamento
	66	x	O *2, 3, 4	Sostenuto
	67	x	O *2, 3, 4	Soft
	71	x	O *3	Resonance
	72	x	O *3	Release Time
	73	x	O *3	Attack Time
	74	x	O *3	Cut off
	75	x	O *3	Decay Time
	76	x	O *3	Vibrato Time
77	x	O *3	Vibrato Depth	
78	x	O *3	Vibrato Delay	
84	x	O *2, 4	Portamento control	
91	x	O *3, 4	Effect1 depth	
93	x	O *3, 4	Effect3 depth	
98, 99	x	O *4	NRPN LSB, MSB	
100, 101	x	O *2, 3, 4, 5	RPN LSB, MSB	
Prog Change :	True #	0-127 *1 *****	O *3, 4, 5 0-127	Program number 1-128
System Exclusive		x	O	
System Common	: Song Pos : Song Sel : Tune	x x x	x x x	
System Real Time	: Clock : Commands	O O	x x	
Aux Message	: All sound off : Reset all controllers : Local Control : All Notes OFF : Active Sense : Reset	x x x x O x	O (120, 126, 127) *3, 4 O *3, 4 x O (123-125) *3, 4, 5 O x	
Notes	* 1 O x is selectable. * 2 O x is selectable by SysEx. (GS Part) * 3 Received in GM2 mode * 4 Received in GS mode * 5 Received in General MIDI mode		* 6 Bass part cannot be changed * Received messages are transmitted to GS2/GS part. Keyboard part cannot be controlled.	

Mode 1 : OMNI ON, POLY  
Mode 3 : OMNI OFF, POLY

Mode 2 : OMNI ON, MONO  
Mode 4 : OMNI OFF, MONO

O : Yes  
X : No

# Demo Song List

To play the Demo Songs, please refer to "Listening to the Demo Songs" (p. 17).

Song Title	Composer	Player	Copyright
Jazz Combo	Ric Iannone	Ric Iannone	© 2003 Roland Corporation
Slow Waltz	Ric Iannone	Ric Iannone	© 2003 Roland Corporation
Hawaiian	Ric Iannone	Ric Iannone	© 2003 Roland Corporation
Dixieland	Ric Iannone	Ric Iannone	© 2003 Roland Corporation
Country	Ric Iannone	Ric Iannone	© 2003 Roland Corporation
Organ Swing	Hal Vincent	Hal Vincent	© 2001 Roland Corporation
Soft Gospel	Ric Iannone	Ric Iannone	© 2001 Roland Corporation
Acoustic	Ric Iannone	Ric Iannone	© 2001 Roland Corporation

\* All rights reserved. Unauthorized use of this material for purposes other than private, personal enjoyment is a violation of applicable laws.

\* No data for the music that is played will be output from MIDI OUT.

## ■ Profile

### Hal Vincent

Hal consistently delights his audiences with his keyboard artistry. He is equally at home on either the organ, piano, or electronic keyboard. Around the world, his concerts generate the often heard comment "...we loved it because he plays our kind of music." This is another of Hal's special skills: a knack for knowing just what music to play on any occasion.

An extensive repertoire combined with more than 30 years of world touring have netted Hal rave reviews while affording him the opportunity to work with some of the top names in show business. Hal has recorded several albums and published books of organ arrangements while establishing himself as an excellent clinician and teacher.

### Ric Iannone

Ric Iannone began playing the piano and accordion at the age of two and a half. By the time he was seven, he was performing public and private engagements with his musician father. For more than 20 years Ric has performed and traveled extensively throughout the United States and Europe, delighting audiences with his unique playing style and music arrangements. He is equally comfortable playing the organ, piano or keyboard, as a concert artist and product demonstrator.

# Index

- A**  
AC Adaptor .....14  
Arrangement .....29, 74  
Arranger Function .....30  
Auto Std Tempo (Auto Standard Tempo) .....64  
Automatic Accompaniment .....30
- B**  
Basic Chord .....74  
Basic Pitch .....65  
Basic Screen .....16  
Bass To Lower Button .....23  
BassReplaceRec (Bass Replace Recording) .....60  
Beat .....58  
Beat Indicator .....29
- C**  
Ch.Mute (Channels Mute) .....59  
Chord .....72, 74  
Composer .....39, 56  
Composer Screen .....16  
Contrast of the Screen .....16  
Cord Hook .....14  
Count Down Sound .....64  
Count-In .....43
- D**  
Damper Pedal .....37  
Delete Song .....53  
Deleting  
    Performance Songs on Floppy Disk .....53  
Demo Song .....17, 77  
Demo Song List .....77  
Disk Utility .....49, 53  
Display of Lyrics .....61
- E**  
Ending .....28, 74  
Erasing  
    Performance Song .....47  
Exp. Source .....60–61  
Expression Pedal .....37  
    Function .....60–61
- F**  
Factory Default Settings .....16  
Factory Reset .....16  
Floppy Disk  
    Format .....48  
Foot Switch .....38, 63  
Format .....48  
Format Disk .....49
- G**  
General MIDI .....75  
General MIDI 2 .....75  
Glide .....63, 74  
GS format .....75
- H**  
Harmony Intelligence .....31–32  
Headphones .....15
- I**  
Initial Touch .....63  
Intro .....27, 74  
Intro Count Down .....64  
Inversion .....74
- K**  
Key Transpose .....36
- L**  
LCD Contrast knob .....16  
Left Foot Sw .....63  
Lower Voice .....20–21  
Lyrics .....61
- M**  
Master Tune .....65  
Master Volume .....15, 37  
Metronome .....56  
    Sound .....57  
    Volume .....57  
MIDI .....67  
Music Stand .....14  
Mute .....74  
Muting  
    Channel .....59  
    Track .....58
- N**  
Name  
    Performance Song .....50
- O**  
Octave Shift .....25  
One Touch Program .....30  
Others Button .....22
- P**  
Panel Settings .....74  
Part .....20  
Part Balance .....24  
Pedal .....37  
Play Transpose .....56  
Playing  
    Demo Song .....17  
    Performance Song .....45  
    Rhythms .....27  
    SMF Music Files .....40  
Power On .....15
- R**  
Recording .....43, 54  
    Re-Recording .....46, 55  
Rename  
    Performance Song .....50  
Re-recording .....46, 55  
    Re-recording the Bass Performance .....60

---

Reverb Effect .....	34, 74
Rhythm .....	26
Accompaniment .....	29
Ending .....	28
Fill In .....	29
Intro .....	27
Starting and Stopping .....	27
Rhythm Screen .....	16
Right Foot Sw .....	63
Root Note .....	74
Rotary Effect .....	33

**S**

Saving	
Performance Song .....	51
SMF .....	51
SMF Format .....	40
SMF Music Files .....	40, 54
Track Assignment .....	42
SMF with Lyrics .....	75
Sound Generator .....	75
Sustain Effect .....	35, 62
Sustain Length .....	62
Sync Start .....	30

**T**

Tempo .....	29
Tempo Recording .....	55
Track .....	58
Track Mute .....	42, 58, 74
Transpose	
Key Transpose .....	36
Playing Back .....	56
Tx MIDI Channel .....	65

**U**

Upper Voice .....	20–21
-------------------	-------

**V**

Voice .....	19
Volume	
Master .....	15
Metronome .....	57
Part Balance .....	24

**X**

XG lite .....	75
---------------	----

---

# MEMO



---

# MEMO

# Information

When you need repair service, call your nearest Roland Service Center or authorized Roland distributor in your country as shown below.

## AFRICA

### EGYPT

**Al Fanny Trading Office**  
9, EBN Hagar A1 Askalany Street,  
ARD El Golf, Heliopolis,  
Cairo 11341, EGYPT  
TEL: 20-2-417-1828

### REUNION

**Maison FO - YAM Marcel**  
25 Rue Jules Hermann,  
Chaudron - BP79 97 491  
Ste Clotilde Cedex,  
REUNION ISLAND  
TEL: (0262) 218-429

### SOUTH AFRICA

**That Other Music Shop  
(PTY) Ltd.**  
11 Melle St., Braamfontein,  
Johannesburg, SOUTH AFRICA  
  
P.O.Box 32918, Braamfontein 2017  
Johannesburg, SOUTH AFRICA  
TEL: (011) 403 4105

**Paul Bothner (PTY) Ltd.**  
17 Werdmuller Centre,  
Main Road, Claremont 7708  
SOUTH AFRICA  
  
P.O. BOX 23032, Claremont 7735,  
SOUTH AFRICA  
TEL: (021) 674 4030

## ASIA

### CHINA

**Roland Shanghai Electronics  
Co., Ltd.**  
5F, No.1500 Pingliang Road  
Shanghai 200090, CHINA  
TEL: (021) 5580-0800

**Roland Shanghai Electronics  
Co., Ltd.  
(BEIJING OFFICE)**  
10F, No.18 Anhuaxili  
Chaoyang District, Beijing 100011  
CHINA  
TEL: (010) 6426-5050

**Roland Shanghai Electronics  
Co., Ltd.  
(GUANGZHOU OFFICE)**  
2/F., No.30 Si You Nan Er Jie Yi  
Xiang, Wu Yang Xin Cheng,  
Guangzhou 510600, CHINA  
TEL: (020) 8736-0428

### HONG KONG

**Tom Lee Music Co., Ltd.  
Service Division**  
22-32 Pun Shan Street, Tsuen  
Wan, New Territories,  
HONG KONG  
TEL: 2415 0911

### Parsons Music Ltd.

8th Floor, Railway Plaza, 39  
Chatham Road South, T.S.T.,  
Kowloon, HONG KONG  
TEL: 2333 1863

### INDIA

**Rivera Digitec (India) Pvt. Ltd.**  
409, Nirman Kendra Mahalaxmi  
Flats Compound Off. Dr. Edwin  
Moses Road, Mumbai-400011,  
INDIA  
TEL: (022) 2493 9051

### INDONESIA

**PT Citra IntiRama**  
Jl. Cideng Timur No. 15J-150  
Jakarta Pusat  
INDONESIA  
TEL: (021) 6324170

### KOREA

**Cosmos Corporation**  
1461-9, Seocho-Dong,  
Seocho Ku, Seoul, KOREA  
TEL: (02) 3486-8855

### MALAYSIA

**BENTLEY MUSIC SDN BHD**  
140 & 142, Jalan Bukit Bintang  
55100 Kuala Lumpur, MALAYSIA  
TEL: (03) 2144-3333

### PHILIPPINES

**G.A. Yupangco & Co. Inc.**  
339 Gil J. Puyat Avenue  
Makati, Metro Manila 1200,  
PHILIPPINES  
TEL: (02) 899 9801

### SINGAPORE

**Swee Lee Company**  
150 Sims Drive,  
SINGAPORE 387381  
TEL: 6846-3676

### CRISTOFORI MUSIC PTE LTD

Blk 3014, Bedok Industrial Park E,  
#02-2148, SINGAPORE 489980  
TEL: 6243-9555

### TAIWAN

**ROLAND TAIWAN  
ENTERPRISE CO., LTD.**  
Room 5, 9H, No. 112 Chung Shan  
N.Road Sec.2, Taipei, TAIWAN,  
R.O.C.  
TEL: (02) 2561 3339

### THAILAND

**Theera Music Co., Ltd.**  
330 Verng NakornKasem, Soi 2,  
Bangkok 10100, THAILAND  
TEL: (02) 2248821

### VIETNAM

**Saigon Music**  
Suite DP-8  
40 Ba Huyen Thanh Quan Street  
Hochiminh City, VIETNAM  
Tel: (08) 930-1969

## AUSTRALIA/ NEW ZEALAND

### AUSTRALIA

**Roland Corporation  
Australia Pty., Ltd.**  
38 Campbell Avenue  
Dee Why West, NSW 2099  
AUSTRALIA  
TEL: (02) 9982 8266

### NEW ZEALAND

**Roland Corporation Ltd.**  
32 Shaddock Street, Mount Eden,  
Auckland, NEW ZEALAND  
TEL: (09) 3098 715

## CENTRAL/LATIN AMERICA

### ARGENTINA

**Instrumentos Musicales S.A.**  
Av. Santa Fe 2055  
(1123) Buenos Aires  
ARGENTINA  
TEL: (011) 4508-2700

### BRAZIL

**Roland Brasil Ltda**  
Rua San Jose, 780 Sala B  
Parque Industrial San Jose  
Cotia - Sao Paulo - SP, BRAZIL  
TEL: (011) 4615 5666

### COSTA RICA

**JUAN BANSBACH  
Instrumentos Musicales**  
Ave.1, Apartado 10237,  
San Jose, COSTA RICA  
TEL: 258-0211

### CHILE

**Comercial Fancy II S.A.**  
Rut.: 96.919.420-1  
Nataniel Cox #739, 4th Floor  
Santiago - Centro, CHILE  
TEL: (02) 688-9540

### EL SALVADOR

**OMNI MUSIC**  
75 Avenida Norte y Final  
Alameda Juan Pablo II,  
Edificio No.4010 San Salvador,  
EL SALVADOR  
TEL: 262-0788

### MEXICO

**Casa Veerkamp, s.a. de c.v.**  
Av. Toluca No. 323, Col. Olivar  
de los Padres 01780 Mexico D.F.  
MEXICO  
TEL: (55) 5668-6699

### PANAMA

**SUPRO MUNDIAL, S.A.**  
Boulevard Andrews, Albrook,  
Panama City, REP. DE PANAMA  
TEL: 315-0101

### PARAGUAY

**Distribuidora De  
Instrumentos Musicales**  
J.E. Olear y ESQ. Manduvira  
Asuncion PARAGUAY  
TEL: (021) 492-124

### URUGUAY

**Todo Musica S.A.**  
Francisco Acuna de Figueroa 1771  
C.P.: 11.800  
Montevideo, URUGUAY  
TEL: (02) 924-2335

### VENEZUELA

**Musicland Digital C.A.**  
Av. Francisco de Miranda,  
Centro Parque de Cristal, Nivel  
C2 Local 20 Caracas  
VENEZUELA  
TEL: (212) 285-8586

## EUROPE

### AUSTRIA

**Roland Austria GES.M.B.H.**  
Siemensstrasse 4, P.O. Box 74,  
A-6063 RUM, AUSTRIA  
TEL: (0512) 26 44 260

### BELGIUM/HOLLAND/ LUXEMBOURG

**Roland Benelux N. V.**  
Houtstraat 3, B-2260, Oevel  
(Westerlo) BELGIUM  
TEL: (014) 575811

### DENMARK

**Roland Scandinavia A/S**  
Nordhavnsvej 7, Postboks 880,  
DK-2100 Copenhagen  
DENMARK  
TEL: 3916 6200

### FRANCE

**Roland France SA**  
4, Rue Paul Henri SPAAK,  
Parc de l'Esplanade, F 77 462 St.  
Thibault, Lagny Cedex FRANCE  
TEL: 01 600 73 500

### FINLAND

**Roland Scandinavia As,  
Filial Finland**  
Elannontie 5  
FIN-01510 Vantaa, FINLAND  
TEL: (09) 68 24 020

### GERMANY

**Roland Elektronische  
Musikinstrumente HmbH.**  
Oststrasse 96, 22844 Norderstedt,  
GERMANY  
TEL: (040) 52 60090

### GREECE

**STOLLAS S.A.**  
**Music Sound Light**  
155, New National Road  
Patras 26442, GREECE  
TEL: 2610 435400

### HUNGARY

**Roland East Europe Ltd.**  
Warehouse Area 'DEPO' Pf.83  
H-2046 Torokbalint, HUNGARY  
TEL: (23) 511011

### IRELAND

**Roland Ireland**  
G2 Calmount Park, Calmount  
Avenue, Dublin 12  
Republic of IRELAND  
TEL: (01) 4294444

### ITALY

**Roland Italy S. p. A.**  
Viale delle Industrie 8,  
20020 Arese, Milano, ITALY  
TEL: (02) 937-78300

### NORWAY

**Roland Scandinavia Avd.  
Kontor Norge**  
Lilleakerveien 2 Postboks 95  
Lilleaker N-0216 Oslo  
NORWAY  
TEL: 2273 0074

### POLAND

**P. P. H. Brzostowicz**  
UL. Gibraltarska 4.  
PL-03664 Warszawa POLAND  
TEL: (022) 679 44 19

### PORTUGAL

**Tecnologias Musica e Audio,  
Roland Portugal, S.A.**  
Cais Das Pedras, 8/9-1 Dto  
4050-465 PORTO  
PORTUGAL  
TEL: (022) 608 00 60

### ROMANIA

**FBS LINES**  
Piata Libertatii 1,  
RO-4200 Gheorgheghi  
TEL: (095) 169-5043

### RUSSIA

**MuTek**  
3-Bogatyrskaya Str. 1.k.1  
107 564 Moscow, RUSSIA  
TEL: (095) 169 5043

### SPAIN

**Roland Electronics  
de España, S. A.**  
Calle Bolivia 239, 08020  
Barcelona, SPAIN  
TEL: (93) 308 1000

### SWEDEN

**Roland Scandinavia A/S  
SWEDISH SALES OFFICE**  
Danvik Center 28, 2 tr.  
S-131 30 Nacka SWEDEN  
TEL: (0)8 702 00 20

### SWITZERLAND

**Roland (Switzerland) AG**  
Landstrasse 5, Postfach,  
CH-4452 Itingen,  
SWITZERLAND  
TEL: (061) 927-8383

### UKRAINE

**TIC-TAC**  
Mira Str. 19/108  
P.O. Box 180  
295400 Munkachevo, UKRAINE  
TEL: (03131) 414-40

### UNITED KINGDOM

**Roland (U.K.) Ltd.**  
Atlantic Close, Swansea  
Enterprise Park, SWANSEA  
SA7 9FJ,  
UNITED KINGDOM  
TEL: (01792) 702701

## MIDDLE EAST

### BAHRAIN

**Moon Stores**  
No.16, Bab Al Bahrain Avenue,  
P.O.Box 247, Manama 304,  
State of BAHRAIN  
TEL: 211 005

### CYPRUS

**Radex Sound Equipment Ltd.**  
17, Diagorou Street, Nicosia,  
CYPRUS  
TEL: (022) 66-9426

### IRAN

**MOCO, INC.**  
No.41 Nike St., Dr.Shariyati Ave.,  
Roberoye Cerah Mirdamad  
Tehran, IRAN  
TEL: (021) 285-4169

### ISRAEL

**Halilit P. Greenspoon &  
Sons Ltd.**  
8 Retzif Ha'aliya Hashnya St.  
Tel-Aviv-Yafo ISRAEL  
TEL: (03) 6823666

### JORDAN

**AMMAN Trading Agency**  
245 Prince Mohammad St.,  
Amman 1118, JORDAN  
TEL: (06) 464-1200

### KUWAIT

**Easa Husain Al Yousifi Est.**  
Abdullah Salem Street,  
Safat, KUWAIT  
TEL: 243-6399

### LEBANON

**Chahine S.A.L.**  
Gerge Zeidan St., Chahine Bldg.,  
Achrafieh, P.O.Box: 16-5857  
Beirut, LEBANON  
TEL: (01) 20-1441

### QATAR

**Al Emadi Co. (Badie Studio  
& Stores)**  
P.O. Box 62, Doha, QATAR  
TEL: 4423-554

### SAUDI ARABIA

**aDawlah Universal  
Electronics APL**  
Corniche Road, Aldossary Bldg.,  
1st Floor, Alkhobar,  
SAUDI ARABIA  
  
P.O.Box 2154, Alkhobar 31952  
SAUDI ARABIA  
TEL: (03) 898 2081

### SYRIA

**Technical Light & Sound  
Center**  
Khaled Ebn Al Walid St.  
Bldg. No. 47, P.O.BOX 13520,  
Damascus, SYRIA  
TEL: (011) 223-5384

### TURKEY

**Barkat muzik aletleri ithalat  
ve ihracat Ltd Sti**  
Siraselviler Caddesi Siraselviler  
Pasaji No:74/20  
Taksim - Istanbul, TURKEY  
TEL: (0212) 2499324

### U.A.E.

**Zak Electronics & Musical  
Instruments Co. L.L.C.**  
Zabeel Road, Al Sherooq Bldg.,  
No. 14, Grand Floor, Dubai, U.A.E.  
TEL: (04) 3360715

## NORTH AMERICA

### CANADA

**Roland Canada Music Ltd.  
(Head Office)**  
5480 Parkwood Way Richmond  
B. C., V6V 2M4 CANADA  
TEL: (604) 270 6626

### Roland Canada Music Ltd. (Toronto Office)

170 Admiral Boulevard  
Mississauga On L5T 2N6  
CANADA  
TEL: (905) 362 9707

### U. S. A.

**Roland Corporation U.S.**  
5100 S. Eastern Avenue  
Los Angeles, CA 90040-2938,  
U. S. A.  
TEL: (323) 890 3700



This product complies with the requirements of European Directive 89/336/EEC.

For EU Countries

## FEDERAL COMMUNICATIONS COMMISSION RADIO FREQUENCY INTERFERENCE STATEMENT

For the USA

This equipment has been tested and found to comply with the limits for a Class B digital device, pursuant to Part 15 of the FCC Rules. These limits are designed to provide reasonable protection against harmful interference in a residential installation. This equipment generates, uses, and can radiate radio frequency energy and, if not installed and used in accordance with the instructions, may cause harmful interference to radio communications. However, there is no guarantee that interference will not occur in a particular installation. If this equipment does cause harmful interference to radio or television reception, which can be determined by turning the equipment off and on, the user is encouraged to try to correct the interference by one or more of the following measures:

- Reorient or relocate the receiving antenna.
- Increase the separation between the equipment and receiver.
- Connect the equipment into an outlet on a circuit different from that to which the receiver is connected.
- Consult the dealer or an experienced radio/TV technician for help.

This device complies with Part 15 of the FCC Rules. Operation is subject to the following two conditions:

- (1) This device may not cause harmful interference, and
- (2) This device must accept any interference received, including interference that may cause undesired operation.

Unauthorized changes or modification to this system can void the users authority to operate this equipment.  
This equipment requires shielded interface cables in order to meet FCC class B Limit.

For Canada

### NOTICE

This Class B digital apparatus meets all requirements of the Canadian Interference-Causing Equipment Regulations.

### AVIS

Cet appareil numérique de la classe B respecte toutes les exigences du Règlement sur le matériel brouilleur du Canada.

