

marantz®

Model PD5020D User Guide

Plasma Monitor

Important Information

Precautions

Please read this manual carefully before using your Marantz plasma monitor and keep the manual handy for future reference.

CAUTION



**RISK OF ELECTRIC SHOCK
DO NOT OPEN**



CAUTION: TO REDUCE THE RISK OF ELECTRIC SHOCK, DO NOT REMOVE COVER. NO USER-SERVICEABLE PARTS INSIDE. REFER SERVICING TO QUALIFIED SERVICE PERSONNEL.

 This symbol warns the user that uninsulated voltage within the unit may have sufficient magnitude to cause electric shock. Therefore, it is dangerous to make any kind of contact with any part inside of this unit.

 This symbol alerts the user that important literature concerning the operation and maintenance of this unit has been included. Therefore, it should be read carefully in order to avoid any problems.

WARNING

TO PREVENT FIRE OR SHOCK HAZARDS, DO NOT EXPOSE THIS UNIT TO RAIN OR MOISTURE. ALSO DO NOT USE THIS UNIT'S POLARIZED PLUG WITH AN EXTENSION CORD RECEPTACLE OR OTHER OUTLETS, UNLESS THE PRONGS CAN BE FULLY INSERTED. REFRAIN FROM OPENING THE CABINET AS THERE ARE HIGH-VOLTAGE COMPONENTS INSIDE. REFER SERVICING TO QUALIFIED SERVICE PERSONNEL.

Warning

This equipment has been tested and found to comply with the limits for a Class A digital device, pursuant to Part 15 of the FCC Rules. These limits are designed to provide reasonable protection against harmful interference when the equipment is operated in a commercial environment. This equipment generates, uses, and can radiate radio frequency energy and, if not installed and used in accordance with the instruction manual, may cause harmful interference to radio communications. Operation of this equipment in a residential area is likely to cause harmful interference in which case the user will be required to correct the interference at his own expense.

Warnings and Safety Precaution

The Marantz plasma monitor is designed and manufactured to provide long, trouble-free service. No maintenance other than cleaning is required. Use a soft dry cloth to clean the panel. Never use solvents such as alcohol or thinner to clean the panel surface.

The plasma display panel consists of fine picture elements (cells). Although Marantz produces the plasma display panels with more than 99.99 percent active cells, there may be some cells that do not produce light or remain lit.

For operating safety and to avoid damage to the unit, read carefully and observe the following instructions. To avoid shock and fire hazards:

1. Provide adequate space for ventilation to avoid internal heat build-up. Do not cover rear vents or install the unit in a closed cabinet or shelves.
The unit is equipped with cooling fans. If you install the unit in an enclosure, make sure there is adequate space at the top of the unit to allow hot air to rise and escape. If the monitor becomes too hot, the overheat protector will be activated and the monitor will be turned off. If this happens, turn off the power to the monitor and unplug the power cord. If the room where the monitor is installed is particularly hot, move the monitor to a cooler location, and wait for 60 minutes to cool the monitor. If the problem persists, contact your Marantz dealer for service.
2. Do not use the polarized plug of this unit with extension cords or outlets unless the prongs can be completely inserted.
3. Do not expose the unit to water or moisture.
4. Avoid damage to the power cord, and do not attempt to modify the power cord.
5. Unplug the power cord during electrical storms or if the unit will not be used over a long period.
6. Do not open the cabinet which has potentially dangerous high voltage components inside. If the unit is damaged in this way the warranty will be void. Moreover, there is a serious risk of electric shock.
7. Do not attempt to service or repair the unit. Marantz is not liable for any bodily harm or damage caused if unqualified persons attempt service or open the back cover. Refer all service to authorized Marantz Service Centers.

NOTE:

When you connect a computer to this monitor, attach the supplied ferrite cores. If you do not do this, this monitor will not conform to mandatory FCC standards.

Attaching the ferrite cores:

Set the ferrite cores on both ends of the DVI cable (not supplied), and both ends of the power cable (supplied).

Close the lid tightly until the clamps click.

Use the band to fasten the ferrite core (supplied) to the DVI cable.

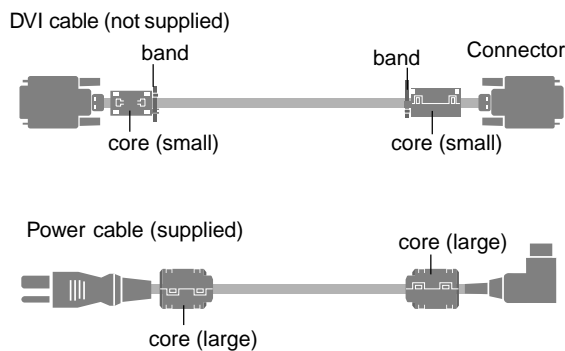

To avoid damage and prolong operating life:

1. Use only with 120V 50/60Hz AC power supply. Continued operation at line voltages greater than 120 Volts AC will shorten the life of the unit, and might even cause a fire hazard.
2. Handle the unit carefully when installing it and do not drop.
3. Set the unit away from heat, excessive dust, and direct sunlight.
4. Protect the inside of the unit from liquids and small metal objects. In case of accident, unplug the unit and have it serviced by an authorized Marantz Service Center.
5. Do not hit or scratch the panel surface as this causes flaws on the surface of the screen.
6. For correct installation and mounting it is strongly recommended to use a trained, authorized Marantz dealer.
7. As is the case with any phosphor-based display (like a CRT monitor, for example) light output will gradually decrease over the life of a Plasma Display Panel.

Recommendations to avoid or minimize phosphor burn-in

Like all phosphor-based display devices and all other gas plasma displays, plasma monitors can be susceptible to phosphor burn under certain circumstances. Certain operating conditions, such as the continuous display of a static image over a prolonged period of time, can result in phosphor burn if proper precautions are not taken. To protect your investment in this Marantz plasma monitor, please adhere to the following guidelines and recommendations for minimizing the occurrence of image burn:

- * Always enable and use your computer's screen saver function during use with a computer input source.
- * Display a moving image whenever possible.
- * Change the position of the menu display from time to time.
- * Always power down the monitor when you are finished using it.

If the plasma monitor is in long term use or continuous operation take the following measures to reduce the likelihood of phosphor burn:

- * Lower the Brightness and Contrast levels as much as possible without impairing image readability.
- * Display an image with many colors and color gradations (i.e. photographic or photo-realistic images).
- * Create image content with minimal contrast between light and dark areas, for example white characters on black backgrounds. Use complementary or pastel color whenever possible.
- * Avoid displaying images with few colors and distinct, sharply defined borders between colors.

* Burn-in is not covered by the warranty.

Contact Marantz Service Center at 1-800-270-4533 for other recommended procedures that will best suit your particular application needs.

Recommandations importantes

Précautions

Veillez lire ce manuel avec attention avant d'utiliser votre moniteur Plasma Marantz et conserver ce manuel à portée de la main pour une consultation ultérieure.

ATTENTION



**RISQUE D'ELECTROCUTION
NE PAS OUVRIR**



MISE EN GARDE: AFIN DE REDUIRE LES RISQUES D'ELECTROCUTION, NE PAS DEPOSER LE COUVERCLE, IL N'Y A AUCUNE PIECE UTILISABLE A L'INTERIEUR DE CET APPAREIL. NE CONFIER LES TRAVAUX D'ENTRETIEN QU'A UN PERSONNEL QUALIFIE.

Ce symbole a pour but de prévenir l'utilisateur de la présence d'une tension dangereuse, non isolée se trouvant à l'intérieur de l'appareil. Elle est d'une intensité suffisante pour constituer un risque d'électrocution. Eviter le contact avec les pièces à l'intérieur de cet appareil.

Ce symbole a pour but de prévenir l'utilisateur de la présence d'importantes instructions concernant l'entretien et le fonctionnement de cet appareil. Par conséquent, elles doivent être lues attentivement afin d'éviter des problèmes.

AVERTISSEMENT

AFIN DE REDUIRE LES RISQUES D'INCENDIE OU D'ELECTROCUTION, NE PAS EXPOSER CET APPAREIL A LA PLUIE OU A L'HUMIDITE. AUSSI, NE PAS UTILISER LA FICHE POLARISEE AVEC UN PROLONGATEUR OU UNE AUTRE PRISE DE COURANT SAUF SI CES LAMES PEUVENT ETRE INSEREES A FOND. NE PAS OUVRIR LE COFFRET, DES COMPOSANTS HAUTE TENSION SE TROUVENT A L'INTERIEUR. LAISSER A UN PERSONNEL QUALIFIE LE SOIN DE REPARER CET APPAREIL.

DOC avis de conformation

Cet appareil numérique de la classe A respecte toutes les exigences du Règlement sur le Matériel Brouilleur du Canada.

Mises en garde et précautions de sécurité

Le moniteur Plasma Marantz a été conçu et fabriqué pour une utilisation fiable et durable. Il ne nécessite aucun entretien en dehors du nettoyage. Utiliser un chiffon doux et sec pour nettoyer la surface de l'écran. Ne jamais utiliser de solvant comme l'alcool ou le diluant. Le panneau à affichage plasma est constitué de fines particules d'images ou pixels (cellules). Bien que Marantz produise des panneaux à affichage plasma avec plus de 99,99 % de cellules actives, il peut y avoir des cellules qui ne produisent pas de lumière ou qui restent allumées.

Pour des raisons de sécurité et pour éviter d'endommager l'appareil, lire attentivement les instructions suivantes.

Pour éviter les risques d'électrocution et d'incendie:

1. Laisser suffisamment d'espace autour de l'appareil pour la ventilation et éviter toute augmentation excessive de la température interne. Ne pas couvrir les événements ou l'installer dans un endroit trop exigü. L'appareil est équipé de ventilateurs de refroidissement. Si vous installez l'appareil dans un espace clos, assurez-vous qu'il y ait suffisamment d'espace au dessus pour permettre à l'air chaud de s'élever et de s'évacuer. Si la température du moniteur devient excessive, la protection contre les surchauffes entrera en action et coupera l'alimentation. Dans ce cas, éteindre l'appareil et débrancher le câble d'alimentation. Si la température de la pièce dans laquelle se trouve le moniteur est particulièrement élevée, déplacer celui-ci dans un endroit plus frais et attendre environ 60 minutes qu'il refroidisse. Si le problème persiste, prendre contact avec le revendeur Marantz pour le service après-vente.
2. Ne pas raccorder la prise d'alimentation polarisée de ce périphérique à une rallonge ou une prise murale si les fiches ne peuvent pas être complètement insérées.
3. Ne pas exposer à l'eau ou à l'humidité.
4. Eviter d'endommager le cordon d'alimentation, et ne pas modifier le cordon d'alimentation.
5. Débrancher le câble d'alimentation électrique pendant les orages ou les longues périodes d'inactivité.
6. Ne pas ouvrir le coffret. Des composants de haute tension se trouvent à l'intérieur. Si l'appareil est endommagé de cette manière, la garantie devient caduque. De plus, il y a risque d'électrocution.
7. Ne pas essayer de réparer ou entretenir l'appareil soi-même. Marantz ne saura être tenu pour responsable pour toute blessure ou dommage causé par des personnes non qualifiées qui essaient de réparer ou d'ouvrir le couvercle arrière. Confier toute réparation à un centre de service agréé Marantz.

REMARQUE:

Lorsque vous branchez un micro-ordinateur sur ce moniteur, fixez les noyaux en ferrites fournis. Si vous ne le faites, le moniteur ne sera pas en conformité avec les exigences des standards FCC.

Fixation des noyaux en ferrite.

Monter les tores en ferrite aux deux extrémités du câble DVI (non fourni) et aux deux extrémités du câble d'alimentation électrique (fourni).

Fermez doucement le couvercle jusqu'à ce que les crans se clipsent.

Fixer le tore en ferrite (fourni) au câble DVI à l'aide d'un collier.

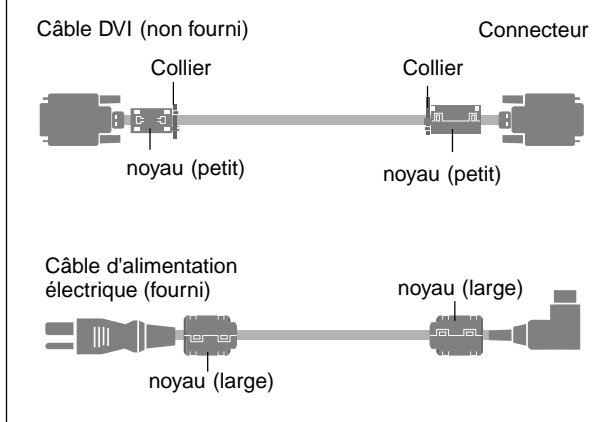

Pour éviter les risques de brûlage du luminophore, les mesures suivantes sont recommandées :

Comme tous les périphériques d'affichage à base luminophore et tous les autres affichages à gaz plasma, les moniteurs plasma peuvent être sujets au brûlage du luminophore dans certaines circonstances. Certaines conditions d'utilisation, telles que l'affichage continu d'une image statique pour une durée prolongée, peuvent causer le brûlage du luminophore si aucune précaution n'est prise. Pour protéger votre investissement dans ce moniteur Plasma Marantz, veuillez suivre les directives et les conseils suivantes pour minimiser l'occurrence le marquage de l'écran:

- Assurez-vous de mettre en marche et d'utiliser l'économisateur d'écran chaque fois que c'est possible lorsque vous l'utilisez avec une source d'entrée d'ordinateur.
- Affichez une image en mouvement aussi souvent que possible.
- Changez la position de l'affichage de menu de temps à autre.
- Coupez toujours l'alimentation lorsque vous avez terminé d'utiliser la moniteur.

Si le moniteur est en usage continu ou longue durée, prenez les mesures suivantes afin d'éviter l'occurrence le brûlage du luminophore:

- Abaissez le niveau de l'image (contraste, luminosité) autant que possible, sans faire perdre la lisibilité de l'image.
- Affichez une image avec de nombreuses couleurs et graduations de couleur (par ex. des images photographiques ou photo-réalistes).
- Créez un contenu d'image avec un contraste minimal entre les zones sombres et les zones claires, par exemple, des caractères blancs sur un fond noir. Utilisez des couleurs complémentaires ou pastels le plus souvent possible.
- Évitez d'afficher des images avec peu de couleurs et des limites nettes et clairement définies entre les couleurs.

* Le brûlage de l'écran n'est pas couvert par la garantie.

Contactez Marantz Service Center au 1-800-270-4533 pour d'autres procédures recommandées qui conviendront le mieux au besoin de votre appareil.

Pour éviter des dommages et prolonger la durée de service de l'appareil:

1. N'utiliser qu'une source d'alimentation de 120 V 50/60 Hz CA. Le fait d'utiliser l'appareil en continu à des tensions de ligne supérieures à 120 Volts CA réduit sa durée de vie et risque de provoquer un incendie.
2. Manipuler l'appareil avec soin pendant son déplacement et ne pas le faire tomber.
3. Eloigner l'appareil des endroits chauds, très poussiéreux et exposés en plein soleil.
4. Éviter que des liquides et des petits objets métalliques pénètrent à l'intérieur de l'appareil. En cas d'accident, débrancher l'appareil et le confier à un centre de service agréé Marantz.
5. Ne pas frapper ou rayer la surface de la écran plasma, car des défauts risquent de se produire sur la surface de la écran plasma.
6. Pour effectuer une installation et un montage corrects, il est recommandé de faire appel au concessionnaire Marantz autorisé et spécialisé.
7. Comme c'est le cas pour tout affichage à base de phosphore (comme un moniteur CRT, par exemple), la puissance de lumière baisse graduellement au cours de la vie du Panneau d'Affichage à Plasma.



Limited Warranty for the Marantz SLIM SERIES PLASMA MONITOR

Who is covered?

You must have proof of purchase to receive warranty service.

What is covered?

- 1) Warranty coverage begins the day you purchase your Plasma Television, and continues for a period of one year.
- 2) Marantz America will provide in-home warranty repair.
- 3) Marantz America will incur all labor charges for repairs during the warranty period.
- 4) Marantz America will incur all freight charges for warranty repairs, both to Marantz and the return to the customer.
We suggest keeping all packing materials for any shipping that might be required.
- 5) All parts, including repaired and replaced parts are covered only for the original warranty period.

When the warranty on the product expires, the warranty on all replaced and repaired parts also expires.

What is excluded?

Your warranty does not cover:

- 1) Labor charges for installation or setup of the product, cleaning, adjustment of customer controls on the product, and installation or repair of antenna systems outside of the product.
- 2) Improper installation, removal or maintenance, or failure to follow instructions supplied with the product.
- 3) Reception problems caused by signal conditions from cable or antenna systems outside the product.
- 4) Repair, attempted repair or modification performed by anyone other than an authorized Marantz America service center.
- 5) Any product, on which the serial number has been defaced, modified or removed.
- 6) Warranty is void if purchase was made from anyone other than an authorized Marantz dealer.
- 7) Warranty is void if purchased from outside The United States of America.
- 8) Warranty only valid in the United States of America.
- 9) Damage due to lightning or power line surges, spikes and brown outs, damages that occur during shipping or transit, or damage which is attributed to acts of God.

- 10) Incidental or consequential damages resulting from the product. (Some states do not allow the exclusion of incidental or consequential damages, so the above exclusion may not apply to you. This warranty gives you specific legal rights, and you may also have other rights that vary from state to state.)
- 11) Commercial or institutional use.
- 12) Any other cause which does not relate to product defect.
- 13) Burns or residual images upon the phosphor of the tubes.

Note: Pixel defect

Plasma is one of the most advanced technologies for consumer products. The panel is made by high precision technology, however some pixel defects may be found on the Plasma display panel. We are trying our best to control the quality in order to reduce the number of defective pixels. It is almost impossible to have zero pixel defects, even using the most advanced technology. This is not a problem only for Marantz, but all Plasma manufacturers. Therefore we have to note that the warranty does not cover the Plasma display panel for pixel defects. We appreciate your understanding.

Before requesting service:

Please check your owner's manual before requesting service. Adjustments of the controls and hook up guidelines discussed there may save you a service call.

To get warranty service:

Repair must be performed by an authorized service center. If you do not know of a Marantz authorized Plasma Television service center, contact your dealer. If your dealer is an authorized service center, they will arrange for repair. If your dealer is not a Marantz authorized Plasma Television service center, they will direct you to an authorized service center. You can also call 1-800-270-4533 for an authorized Marantz service center in your area.

Optimum performance:

For optimum performance and picture quality, the Plasma monitor is only guaranteed up to 6,230 feet above sea level.

Marantz America, Inc.

440 Medinah Road

Roselle, IL 60172-2330

Tel. 630-307-3100 Fax. 630-307-2687

Contents

How to Attach Options to the Plasma Monitor	1	OSM Controls	18
Introduction	2	Menu Operations	18
Introduction to the Plasma Monitor PD5020D	2	Picture Settings Menu	20
The features you'll enjoy include:	2	Adjusting the picture	20
Contents of the Package	2	Setting the picture mode according to the brightness of the room	21
Options	2	Setting the color temperature	22
Part Names and Function	3	Adjusting the color to the desired quality	23
Front View	3	Reducing noise in the picture	24
Rear View / Terminal Board	4	Sound Settings Menu	25
Remote Control	5	Adjusting the treble, bass and left/right balance	25
Battery Installation and Replacement	6	Screen Settings Menu	26
Operating Range	7	Adjusting the Position, Size, Fine Picture, Picture Adj	26
Handling the remote control	7	Function Settings Menu	27
Installation	8	Setting the on-screen menu	27
Connecting Your PC or Macintosh Computer	9	Adjusting the position of the menu display	28
Connections with Equipment that has a Digital Interface ...	9	Setting the power management for computer images	29
Connecting Your Document Camera	9	POWER/STANDBY indicator	30
Connecting Your VCR or Laser Disc Player	9	Setting the gray level for the sides of the screen	31
Connecting Your DVD Player	9	Setting the picture to suit the movie	31
External Speaker Connections	10	Setting RGB3 ADJ	32
Pin Assignments and Signal Levels for 15 pin RGB (Analog)	11	Reducing burn-in of the screen	32
Pin Configuration and Signal of the RGB 3 IN Connector (DVI Connector)	11	Setting the time for "INVERSE"	33
Basic Operations	12	Setting the time for "SCREEN WIPER"	34
POWER	12	Resetting to the default values	35
To turn the unit ON and OFF:	12	Options Settings Menu	36
VOLUME	12	Setting the allocation of the audio connectors	36
To adjust the sound volume:	12	Setting the BNC connectors	36
MUTE	12	Setting a computer image to the correct RGB select screen	37
To cancel the sound:	12	Setting high definition images to the suitable screen size	38
DISPLAY	12	Setting the picture size for RGB input signals	38
To check the settings:	12	Information Menu	39
DIGITAL ZOOM	12	Checking the frequencies, polarities of input signals, and resolution	39
AUTO ADJUST	12	Setting the language for the menus	39
To adjust the size or quality of the picture automatically:	12	Setting the video signal format	40
OFF TIMER	13	External Control	41
To set the off timer:	13	Table of Signals Supported	55
To check the remaining time:	13	Supported resolution	55
To cancel the off timer	13	Troubleshooting	57
WIDE Operations	14	Specifications	58
Watching with a wide screen (manual)	14		
When watching videos or digital video discs	14		
When watching high definition video source	14		
Watching computer images with a wide screen	15		
When "PICTURE SIZE" is set to "OFF"	15		
MULTI SCREEN Operations	16		
Showing a couple of pictures on the screen at the same time	16		
Operations in the Side-by-side mode	16		
Operations in the Picture-in-picture mode	17		
Selecting the input signals to be displayed	17		
Adjusting the OSM controls	17		

How to Attach Options to the Plasma Monitor

You can attach your optional mounts or stand to the plasma monitor in one of the following two ways:

- * While it is upright. (See Drawing A)
- * As it is laid down with the screen face down (See Drawing B). Lay the protective sheet, which was wrapped around the monitor when it was packaged, beneath the screen surface so as not to scratch the screen face.

- **This device cannot be installed on its own. Be sure to use a stand or original mounting unit. (Wall mount unit, Stand, etc.)**
- * See page 2.
- **For correct installation and mounting it is strongly recommended to use a trained, authorized Marantz dealer.**
Failure to follow correct mounting procedures could result in damage to the equipment or injury to the installer.
Product warranty does not cover damage caused by improper installation.

* Use only a listed cart or stand, or mounting kit provided by manufacturer.

Drawing A

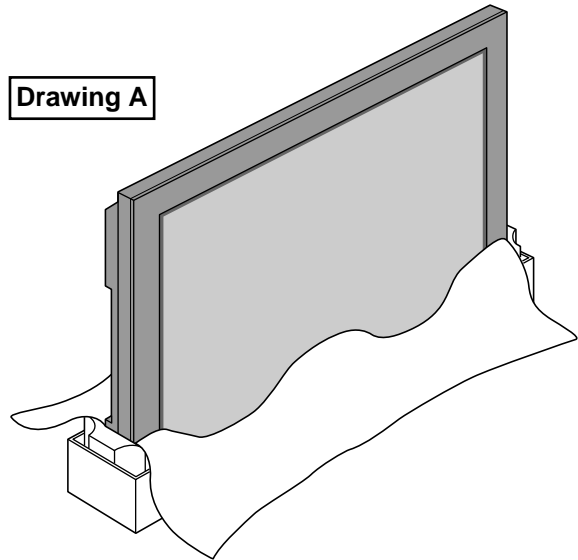

Drawing B

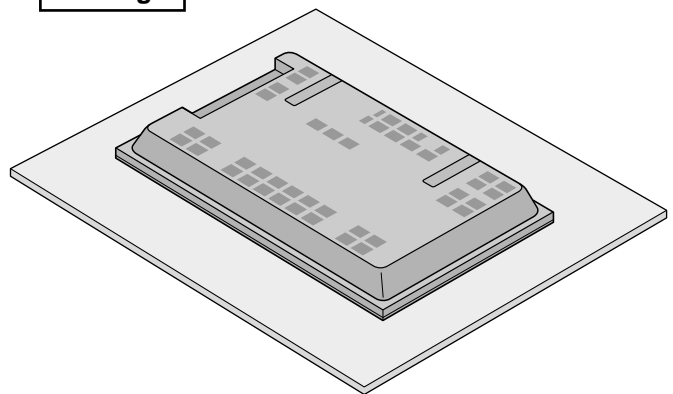

Ventilation Requirements for enclosure mounting

To allow heat to disperse, leave space between surrounding objects as shown on the diagram below when installing.

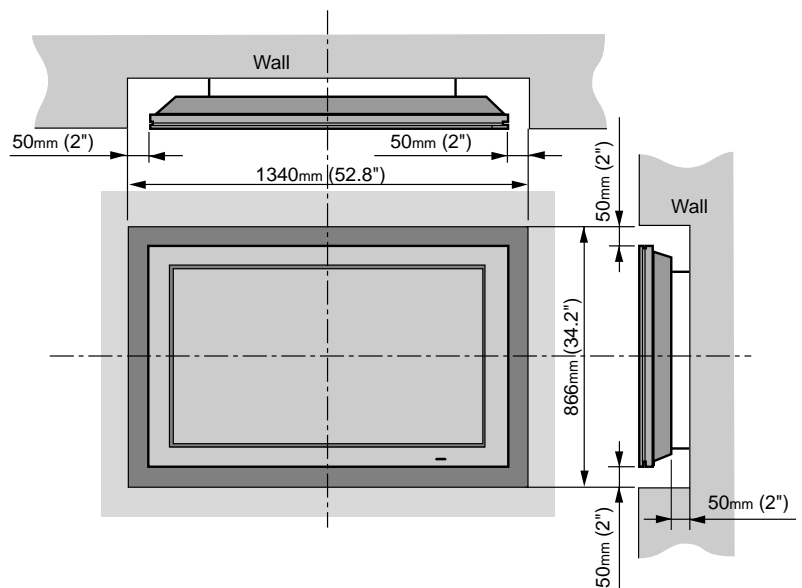

Introduction

Introduction to the Plasma Monitor PD5020D

Marantz's Plasma Monitor is a seamless blend of cutting-edge visual technology and sophisticated design. At 50-inches, with a 16:9 aspect ratio, the Plasma Monitor PD5020D certainly makes a big impression. However, at a mere 4.2 inches/107 mm thin, the monitor's sleek techno-art lines blend in well with your environment. Marantz Plasma Monitor's crisp, vivid image quality will transform data from any graphic medium from PCs to DVD players-into art. And weighing only 98 lbs/ 44.5 kg, it actually can be hung almost anywhere. Marantz has made sure that a host of multimedia resources can be easily connected and displayed as brilliantly as intended on the Marantz Plasma Monitor.

The features you'll enjoy include:

- 50-inch screen
- 16:9 aspect ratio
- Capsulated Color Filter (CCF) and black matrix
- The enhanced display in red uses a two-stage filtering system where Accucrimson is combined with our special CCF.
- 4.2 inch / 107 mm thin
- 98 lbs/ 44.5 kg light
- High-resolution screen: 1365 × 768 pixels
- 160-degrees of off-axis viewing, horizontally and vertically.
- Flicker - and warp - free display provides excellent image geometry even in screen corners
- Not affected by magnetic fields, no color drift or edge distortion.
- VGA, SVGA, XGA, SXGA, UXGA computer signal compatibility
- NTSC, PAL, SECAM, composite and S-Video signal compatibility
- 480P, 1080I, 720P and HDTV signal compatibility
- PCs, VCRs, Laser Disc and DVD player source compatibility
- AccuBlend scan conversion automatically converts VGA, SVGA, XGA, SXGA and UXGA signals to the panel's native resolution
- Advanced Mass Area Sampling Progressive Scan method is employed.
- RGB input (3*), Video input (3), DVD/HD input (2*), Audio input (3), External Control input (1)
- AccuColor control system provides user selectable on-screen color temperature settings
- New Drive Technology
- Component video input terminal for DVD, 15.75kHz (Y, CB, CR)
- Digital broadcasting source compatibly
- Marantz OSM menu-driven on screen control system that makes image adjustments a snap
- Seven languages (English, German, French, Italian, Spanish, Swedish, and Japanese)

- * You can select RGB source or Component source for the 5BNC terminal. When selecting an RGB input, the source is switched to the RGB input (3); when selecting a component input, the source is switched to the DVD/HD input (2).

Contents of the Package

- SLIM SERIES Plasma Monitor
- Power cord
- Remote control with two AAA Batteries
- User's manual
- Safety metal fittings*
- Screws for safety metal fitting*
- Ferrite core (small × 2, large × 2), band

- * These are fittings for fastening the unit to a wall to prevent tipping due to external shock when using the stand (option). Fasten the safety fittings to the holes in the back of the monitor using the safety fitting mount screws.

Options

- Wall mount unit
- Ceiling mount unit
- Tilt mount unit
- Tabletop stand
- Speakers
- Others

Part Names and Function

Front View

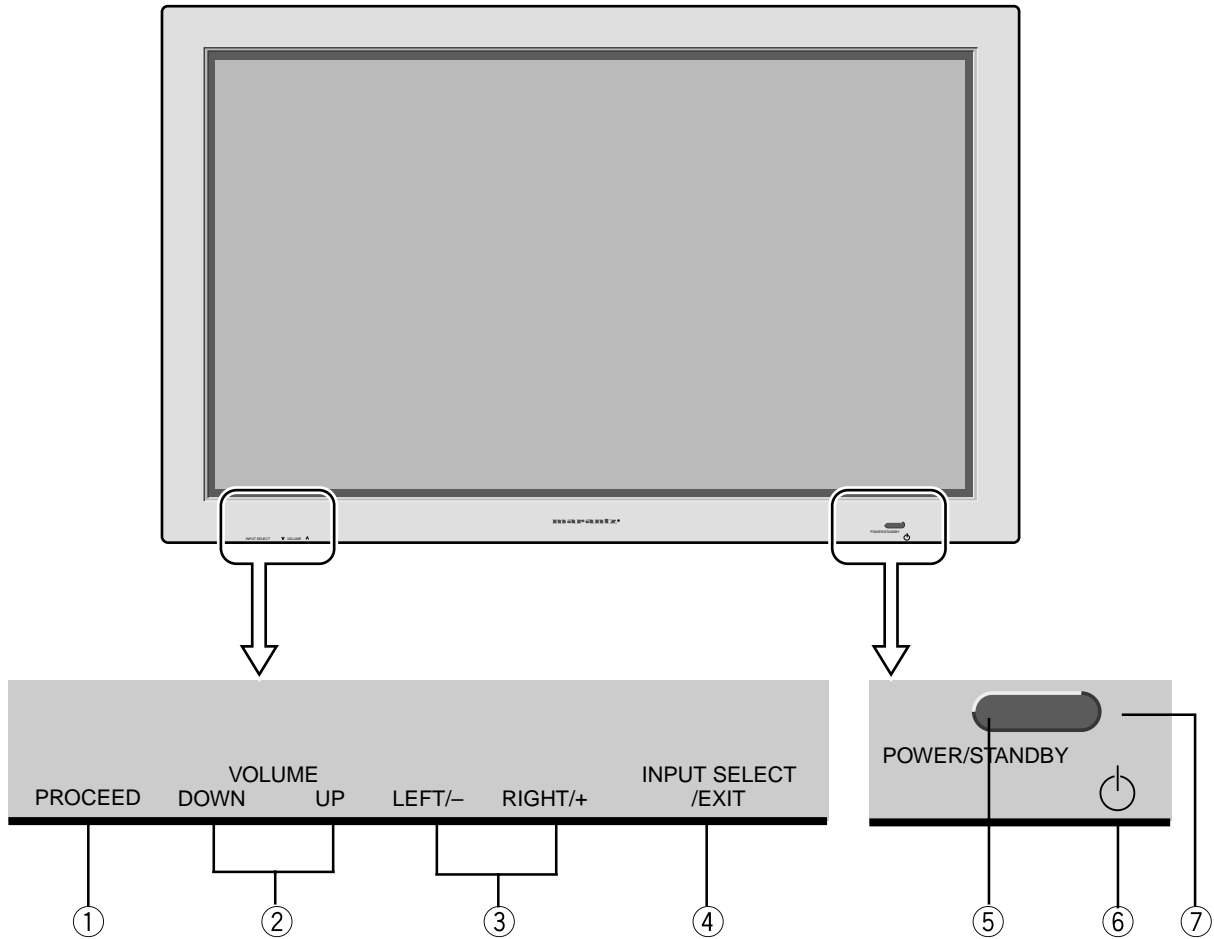

- ① **PROCEED**
Sets the On-Screen Menu (OSM) mode and displays the main menu.
- ② **VOLUME DOWN and UP**
Adjusts the volume. Functions as the CURSOR (▲/▼) buttons in the On-Screen Menu (OSM) mode.
- ③ **LEFT/- and RIGHT/+**
Enlarges or reduces the image. Functions as the CURSOR (◀/▶) buttons in the On-Screen Menu (OSM) mode.
- ④ **INPUT SELECT / EXIT**
Switches the input, in the following order.
The available inputs depend on the setting of “BNC SELECT”.
RGB: [→ VIDEO1 → VIDEO2 → VIDEO3 —————]
[RGB/PC3 ← RGB/PC2 ← RGB/PC1 ← HD/DVD/DTV]
COMP.: [→ VIDEO1 → VIDEO2 → VIDEO3 —————]
[RGB/PC3 ← RGB/PC1 ← HD/DVD/DTV2 ← HD/DVD/DTV1]
Functions as the EXIT buttons in the On-Screen Menu (OSM) mode.
- ⑤ **POWER/STANDBY indicator**
When the power is on Lights green.
When the power is in the standby mode ... Lights red.
- ⑥ **Power**
Turns the monitor’s power on and off.
- ⑦ **Remote sensor window**
Receives the signals from the remote control.

Rear View/ Terminal Board

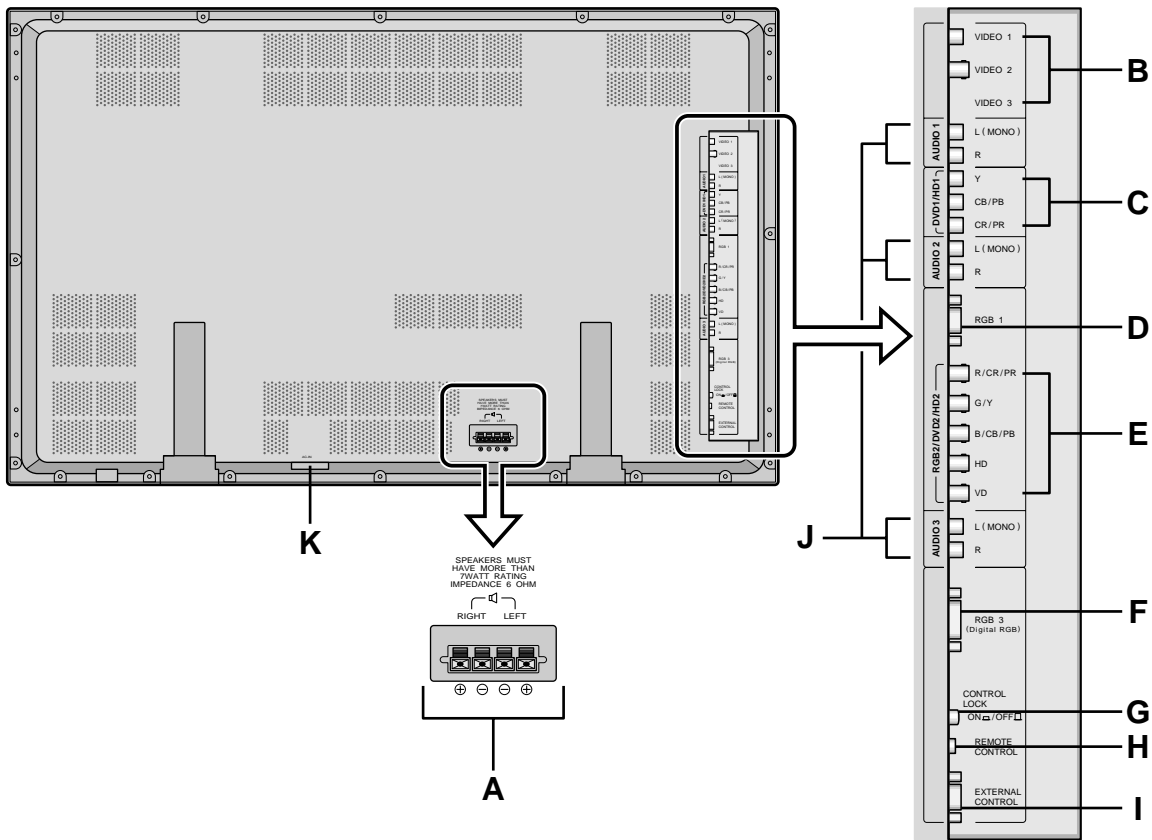

A EXT SPEAKER L and R

Connect speakers here. Maintain the correct polarity.

B VIDEO1, 2, 3

Connect VCR's, DVD's or Laser Discs, etc. here.

C DVD1 / HD1

Connect DVD's, High Definition or Laser Discs, etc. here.

D RGB1

Inputs the analog RGB signal of personal computer, etc.

E RGB2/ DVD2/ HD2

RGB2: Inputs the analog RGB signal, and the synchronized signal.

DVD2/ HD2: Connect DVD's, High Definition or Laser Discs, etc. here.

F RGB3 (DVI 29pin)

Inputs a digital RGB signal (TMDS).

G CONTROL LOCK

When "CONTROL LOCK" is set "ON", the buttons on the set's control panel do not function.

H REMOTE CONTROL

Connect a remote cable here.

I EXTERNAL CONTROL

This terminal is used when power ON/OFF, input selection and AUDIO MUTE and other controls are operated externally (by external control). See also page 41 for external control.

J AUDIO1, AUDIO2, AUDIO3

These are audio input terminals.

The input is selectable. Set which video image to allot them to on the menu screen.

K AC IN

Connect the included power cord here.

Remote Control

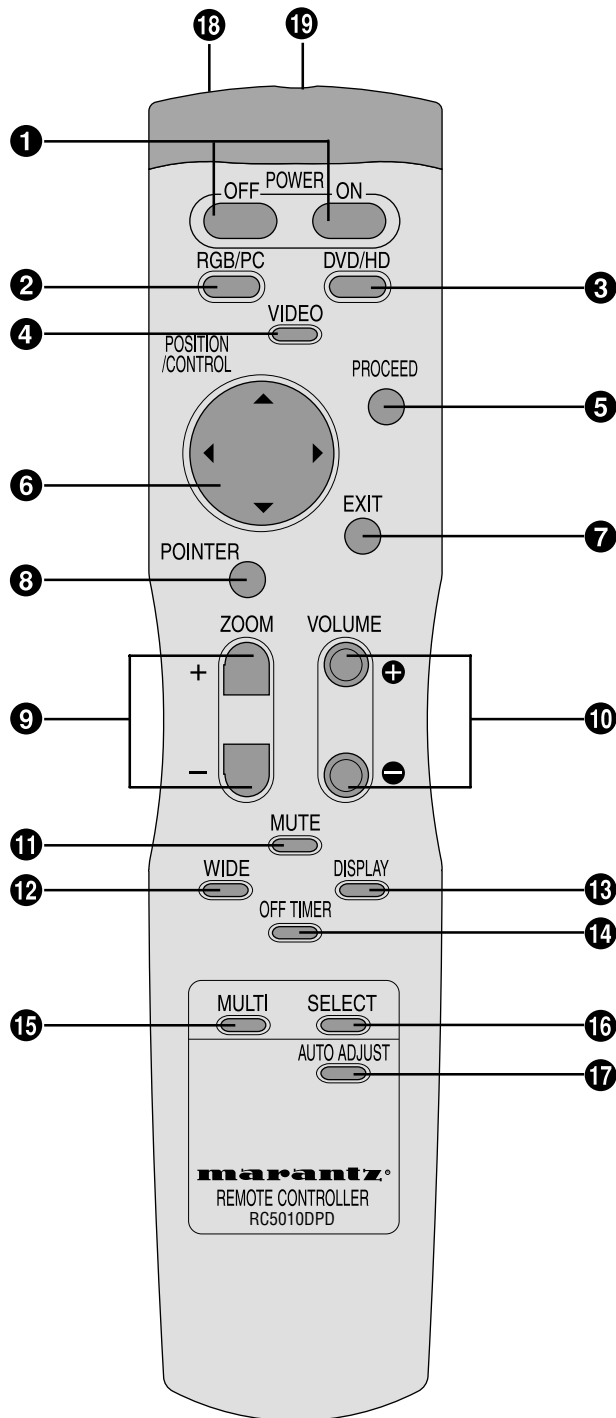

1 POWER ON/OFF

Switches Power ON/OFF.
(This does not operate when POWER/STANDBY indicator of the main unit is off.)

2 RGB/PC

Press this button to select RGB/PC as the source.
The available sources depend on the setting of "BNC SELECT".

RGB:

COMP.:

RGB/PC can also be selected using the INPUT SELECT button on the monitor.

3 DVD / HD

Press this button to select DVD/HD as the source.
The available sources depend on the setting of "BNC SELECT".

RGB: HD/DVD/DTV1

COMP.:

DVD/HD can also be selected using the INPUT SELECT button on the monitor.

4 VIDEO

Press this button to select VIDEO as the source.

VIDEO can also be selected using the INPUT SELECT button on the monitor.

5 PROCEED

Press this button to access the OSM controls.
Press this button during the display of the main menu to go to the sub menu.

6 CURSOR (▲ / ▼ / ◀ / ▶)

Use these buttons to select items or settings and to adjust settings or switch the display patterns.

7 EXIT

Press this button to exit the OSM controls in the main menu. Press this button during the display of the sub menu to return to the main menu.

8 POINTER

Press this button to display the pointer.

9 ZOOM (+ / -)

Enlarges or reduces the image.

10 VOLUME (+ / -)

Adjusts the sound volume.

11 MUTE

Mutes the sound.

12 WIDE

The type of broadcast is detected automatically, and the recommended wide screen is set.

13 DISPLAY

Displays the source settings on the screen.

14 OFF TIMER

Activates the off timer for the unit.

15 MULTI

Press this button to select a screen mode from among single mode, side by side, and picture in picture.

16 SELECT

Press this button to select the active picture in a multi screen mode.

17 AUTO ADJUST

Press this button to adjust Fine Picture, Picture ADJ, Position, and Contrast automatically, or to switch the screen size to ZOOM mode automatically with the superimposed caption displayed fully only when the picture contains dark areas above and below the picture.

18 Remote control signal transmitter

Transmits the remote control signals.

19 Remote Jack

Insert the plug of a remote cable here when using the supplied remote control in the wired condition.

Battery Installation and Replacement

Insert the 2 “AAA” batteries, making sure to set them in with the proper polarity.

1. Press and open the cover.

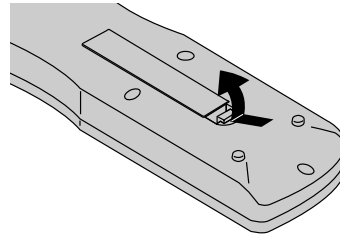

2. Align the batteries according to the (+) and (-) indication inside the case.

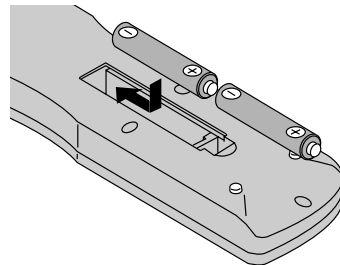

3. Replace the cover.

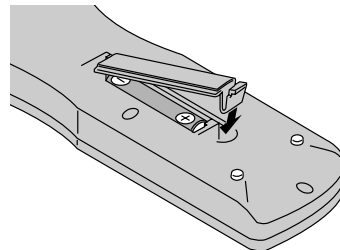

Operating Range

- * Use the remote control within a distance of about 7 m/ 23ft. from the front of the monitor's remote control sensor and at horizontal and vertical angles of up to approximately 30°.
- * The remote control operation may not function if the monitor's remote control sensor is exposed to direct sunlight or strong artificial light, or if there is an obstacle between the sensor and the remote control.

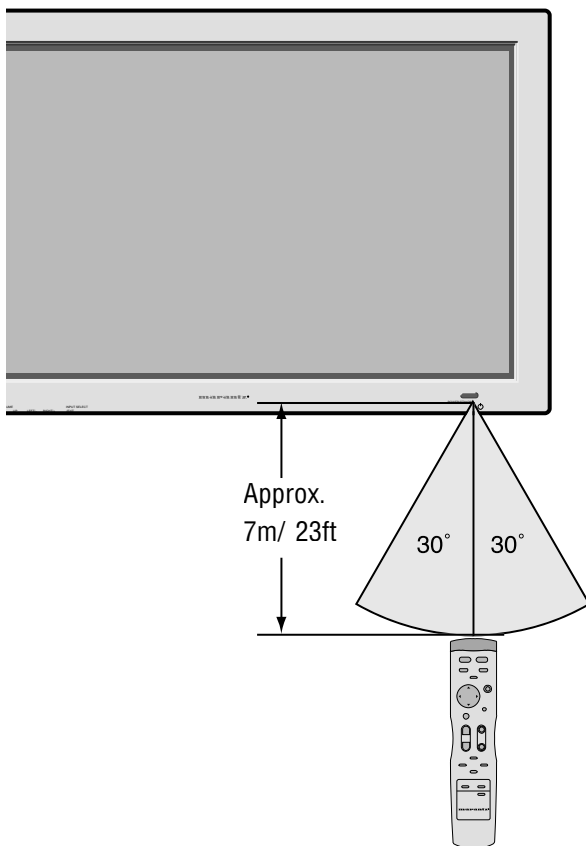

Handling the remote control

- Do not drop or mishandle the remote control.
- Do not get the remote control wet. If the remote control gets wet, wipe it dry immediately.
- Avoid heat and humidity.
- When not using the remote control for a long period, remove the batteries.
- Do not use new and old batteries together, or use different types together.
- Do not take apart the batteries, heat them, or throw them into a fire.

Installation

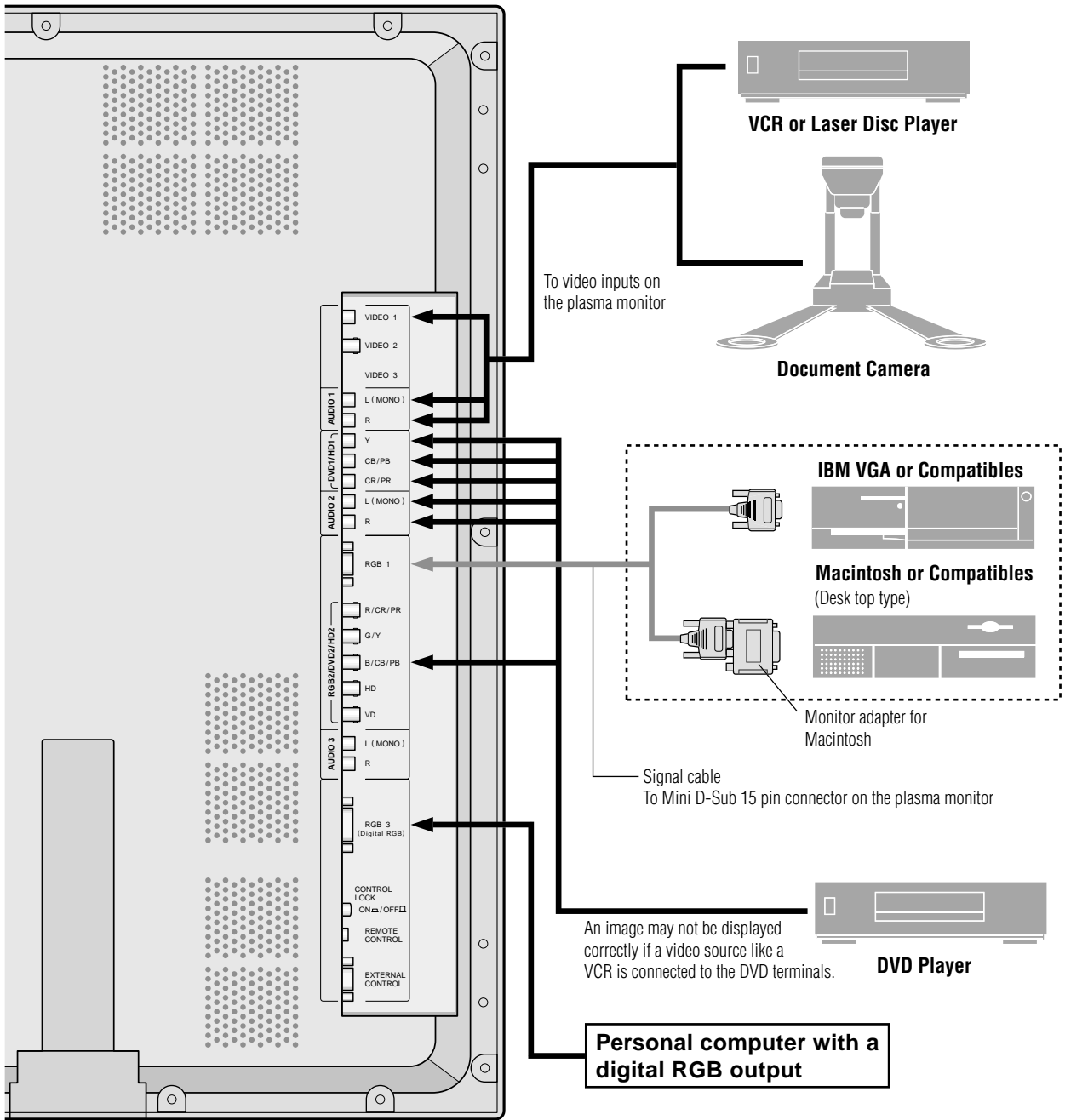

Connecting Your PC or Macintosh Computer

Connecting your PC or Macintosh computer to your plasma monitor will enable you to display your computer's screen image for an impressive presentation. The plasma monitor supports the signals described on page 55.

To connect a PC, Macintosh or compatible graphics adapter, simply:

1. Turn off the power to your plasma monitor and computer.
2. If your PC does not support SXGA/XGA/SVGA/VGA you will need to install an SXGA/XGA/SVGA/VGA graphics board. Consult your computer's owner's manual for your SXGA/XGA/SVGA/VGA configuration. If you need to install a new board, see the manual that comes with your new graphics board for installation instructions.
3. The plasma monitor provides signal compatibility up to VESA 1600 × 1200 (UXGA). However, it is not recommended to use this resolution due to image readability on the monitors 1365 × 768 native pixel resolution panel.
4. Use the signal cable that's supplied to connect your PC or Macintosh computer to the plasma monitor. For Macintosh, use the monitor adapter to connect to your computer's video port.
5. Turn on the plasma monitor and the computer.
6. If the plasma monitor goes blank after a period of inactivity, it may be caused by a screen saver installed on the computer you've connected to the plasma monitor.

When using a Macintosh with the plasma monitor, the following four display standards are supported using the Macintosh adapter :

- 13" fixed mode
- 16" fixed mode
- 19" fixed mode
- 21" fixed mode

The 19" fixed mode is recommended for the plasma monitor.

Connections with Equipment that has a Digital Interface

Connections can be made with equipment that is equipped with a digital interface compliant with the DVI (Digital Visual Interface) standard.

* Use a DVI 29-pin signal cable and the ferrite cores (supplied) when making connections to the RGB3 IN (DVI) connector of the main unit.

Note that the RGB3 IN(DVI) terminal does not support analog RGB input source.

Note:

1. Input TMDS signals conforming to DVI standards. The TMDS input corresponds to 1 link.
2. To maintain display quality, use a cable with a quality prescribed by DVI standards that is within 5 meters in length.

Connecting Your Document Camera

You can connect your plasma monitor to a document camera. To do so, simply:

1. Turn off the power to your plasma monitor and document camera.
2. Use a standard video cable to connect your document camera to the Video input on your plasma monitor.
3. Turn on the plasma monitor and the document camera.

Note: Refer to your document camera owner's manual for more information about your camera's video output requirements.

Connecting Your VCR or Laser Disc Player

Use common RCA cables (not provided) to connect your VCR or laser disc player to your plasma monitor. To make these connections, simply:

1. Turn off the power to your plasma monitor and VCR or laser disc player.
2. Connect one end of your RCA cable to the video output connector on the back of your VCR or laser disc player, connect the other end to the Video input on your plasma monitor. Use standard RCA audio patch cords to connect the audio from your VCR or laser disc player to your plasma monitor (if your VCR or laser disc player has this capability). Be careful to keep your right and left channel connections correct for stereo sound.
3. Turn on the plasma monitor and the VCR or laser disc player.

Note: Refer to your VCR or laser disc player owner's manual for more information about your equipment's video output requirements.

Connecting Your DVD Player

You can connect your plasma monitor to a DVD player. To do so, simply:

1. Turn off the power to your plasma monitor and DVD player.
2. Use a standard video cable to connect your DVD player to the Y, Cb, and Cr inputs on your plasma monitor. Or use the DVD-player's S-Video output. Use a standard S-Video cable to connect to the S-Video input on the plasma monitor.
3. Turn on the plasma monitor and the DVD player.

External Speaker Connections

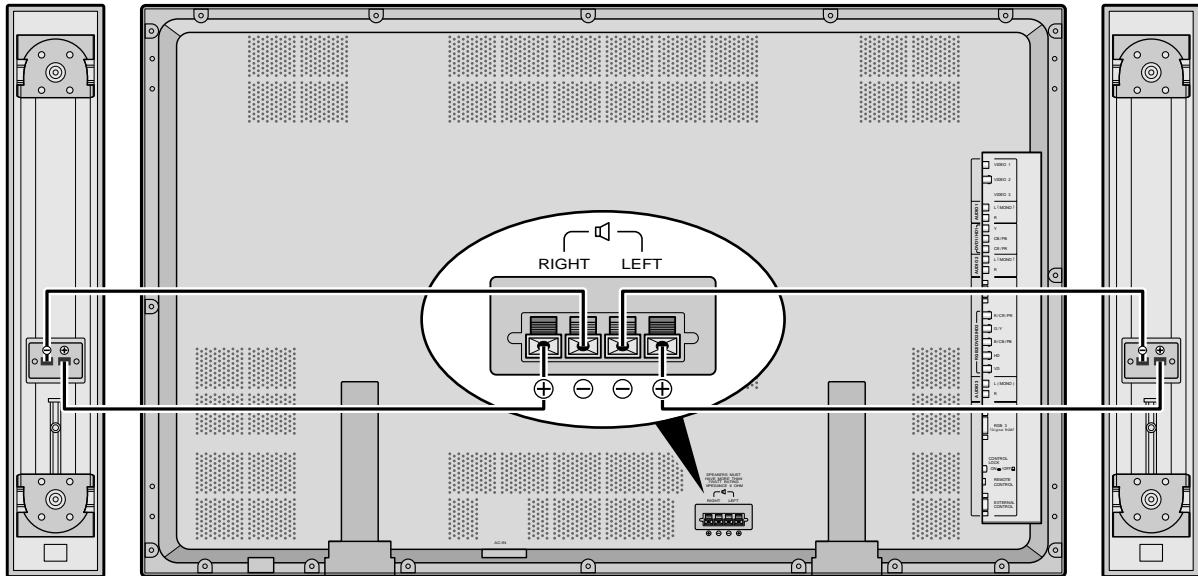

External speakers may be connected to the plasma monitor to reproduce sound from VIDEO, DVD or RGB signal sources.

External speakers may be connected directly to the SPEAKERS terminals or indirectly by connecting a stereo system amplifier to the audio outputs.

CAUTION: *Unplug the plasma monitor and all connected components before connecting external speakers. Use only speakers with 6-ohm impedance and a power input rating of 7 watts or more.*

To connect external speakers directly to the plasma monitor:

1. Strip the ends of the speaker wires.
2. Press down the tabs below the SPEAKERS terminals, insert the speaker wire and release the tab to secure the speaker wire connection:
 - [a] Connect the right speaker (located at right side of the monitor when viewed from the front) positive (+) wire to RIGHT +.
 - [b] Connect the right speaker negative (-) wire to RIGHT -.
 - [c] Connect the left speaker negative (-) wire to LEFT-.
 - [d] Connect the left speaker positive (+) wire to LEFT+.

Pin Assignments and Signal Levels for 15 pin RGB (Analog)

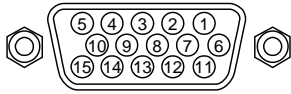

Pin No.	Signal (Analog)
1	Red
2	Green or sync-on-green
3	Blue
4	No connection
5	Ground
6	Red ground
7	Green ground
8	Blue ground
9	No connection
10	Sync signal ground
11	No connection
12	Bi-directional DATA (SDA)
13	Horizontal sync or Composite sync
14	Vertical sync
15	Data clock

Pin Configuration and Signal of the RGB 3 IN Connector (DVI Connector)

The unit is equipped with a type of connector commonly used for both analog and digital.

(Functionally, this cannot be used for an analog input.)

(TMDS can be used for one link only.)

RGB 3

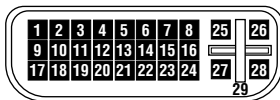

Pin No.	Signal (Digital)
1	T.M.D.S Data 2 -
2	T.M.D.S Data 2 +
3	T.M.D.S Data 2 Shield
4	No connection
5	No connection
6	DDC Clock
7	DDC Data
8	No connection
9	T.M.D.S Data 1 -
10	T.M.D.S Data 1 +
11	T.M.D.S Data 1 Shield
12	No connection
13	No connection
14	+5V Power
15	Ground
16	Hot Plug Detect
17	T.M.D.S Data 0 -
18	T.M.D.S Data 0 +
19	T.M.D.S Data 0 Shield
20	No connection
21	No connection
22	T.M.D.S Clock Shield
23	T.M.D.S Clock +
24	T.M.D.S Clock -
25	No connection
26	No connection
27	No connection
28	No connection
29	No connection

Basic Operations

POWER

To turn the unit ON and OFF:

1. Plug the power cord into an active AC power outlet.
2. Press the POWER ON button (on the remote control) to turn on the unit.

The monitor's POWER/STANDBY indicator will light up (green) when the unit is on.

3. Press the POWER OFF button (on the remote control or the unit) to turn off the unit.

The monitor's POWER/STANDBY indicator turns red and the standby mode is set (only when turning off the unit with the remote control).

VOLUME

To adjust the sound volume:

1. Press and hold the VOLUME ⊕ button (on the remote control or the unit) to increase sound output to the desired level.
2. Press and hold the VOLUME ⊖ button (on the remote control or the unit) to decrease sound output to the desired level.

MUTE

To cancel the sound:

Press the MUTE button on the remote control to cancel the sound; press again to restore.

DISPLAY

To check the settings:

1. The screen changes each time the DISPLAY button is pressed.
2. If the button is not pressed for approximately three seconds, the indication will disappear.

DIGITAL ZOOM

Digital zoom specifies the picture position and enlarges the picture.

1. Press the POINTER button to display the pointer. ()

To change the size of the picture:

Press the ZOOM+ button and enlarge the picture.

The pointer will change to resemble a magnifying glass. ()

A press of the ZOOM- button will reduce the picture and return it to its original size.

To change the picture position:

Select the position with the ▲▼◀▶ buttons.

2. Press the POINTER button to delete the pointer.

AUTO ADJUST

To adjust the size or quality of the picture automatically:

Press the AUTO ADJUST button.

Information

■ AUTO ADJUST ON setting

When RGB (still picture) input is selected Fine Picture, Picture ADJ, Position, and Contrast will be adjusted automatically.

When RGB (motion picture), VIDEO, or Y/Pb/Pr (component) input is selected The screen size switches to ZOOM mode automatically with the superimposed caption displayed fully only when the picture contains dark areas above and below the picture.

OFF TIMER

To set the off timer:

The off timer can be set to turn the power off after 30, 60, 90 or 120 minutes.

1. Press the OFF TIMER button to start the timer at 30 minutes.
2. Press the OFF TIMER button to the desired time.
3. The timer starts when the menu turns off.

→ 30 → 60 → 90 → 120 → 0

OFF TIMER 30



To cancel the off timer:

1. Press the OFF TIMER button twice in a row.
2. The off timer is canceled.

OFF TIMER 0



Note:

*After the power is turned off with the off timer ...
A slight current is still supplied to the monitor. When you are leaving the room or do not plan to use the system for a long period of time, turn off the power of the monitor.*

To check the remaining time:

1. Once the off timer has been set, press the OFF TIMER button once.
2. The remaining time is displayed, then turns off after a few seconds.
3. When five minutes remain the remaining time appears until it reaches zero.

OFF TIMER 28



WIDE Operations

Watching with a wide screen (manual)

With this function, you can select one of four screen sizes.

When watching videos or digital video discs

1. Press the WIDE button on the remote control.
2. *Within 3 seconds ...*

Press the WIDE button again.

The screen size switches as follows:

→ ZOOM → NORMAL → FULL → STADIUM

ZOOM size screen

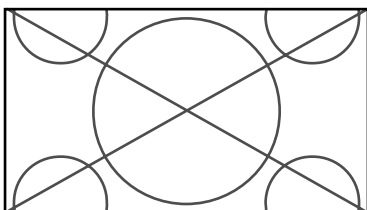

The picture is expanded in the horizontal and vertical direction, maintaining the original proportions.

* Use this for theater size (wide) movies, etc.

NORMAL size screen (4:3)

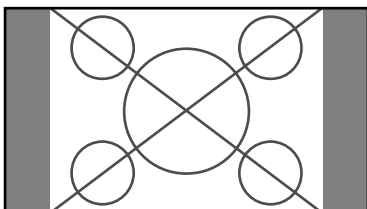

The normal size screen is displayed.

* The picture has the same size as video pictures with a 4 : 3 aspect ratio.

FULL size screen

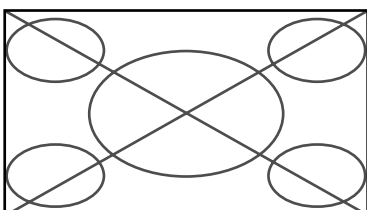

The image is expanded in the horizontal direction.

* Images compressed in the horizontal direction (“squeezed images”) are expanded in the horizontal direction and displayed on the entire screen. (Normal images are expanded in the horizontal direction.)

STADIUM size screen

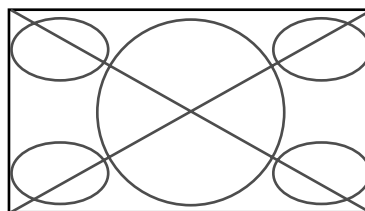

The picture is expanded in the horizontal and vertical directions at different ratios.

* Use this for watching normal video programs (4:3) with a wide screen.

When watching high definition video source

1. Press the WIDE button on the remote control.

FULL size screen (16 : 9)

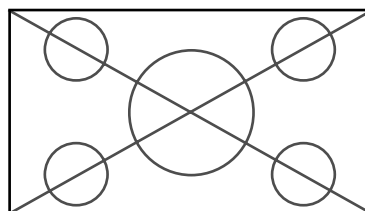

The full size screen is displayed.

* The picture has the same size as video pictures (16 : 9).

Watching computer images with a wide screen

Switch to the wide screen mode to expand the 4 : 3 image to fill the entire screen.

1. Press the WIDE button on the remote control.
2. *Within 3 seconds ...*

Press the WIDE button again.

The screen size switches as follows:

→ NORMAL → FULL →

NORMAL size screen (4:3 or SXGA 5:4)

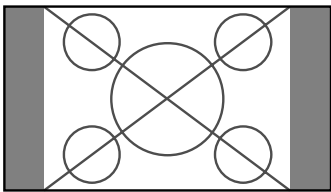

The picture has the same size as the normal computer image.

FULL size screen

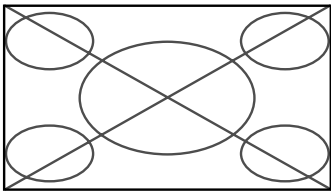

The image is expanded in the horizontal direction.

When wide signals are input.

FULL size screen

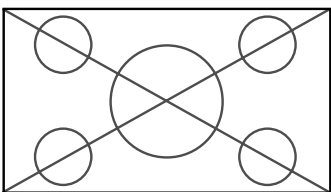

When "PICTURE SIZE" is set to "OFF"

The screen size switches as follows:

→ TRUE → FULL →

TRUE size screen (VGA, SVGA 4:3)

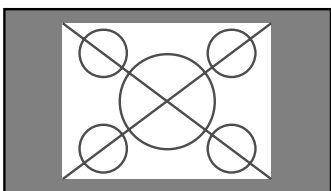

The image is true resolution.

FULL size screen

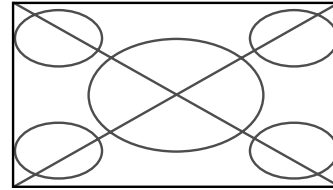

The image is expanded in the horizontal and vertical direction.

When wide signals are input.

TRUE

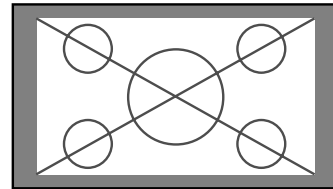

The image is true resolution.

FULL

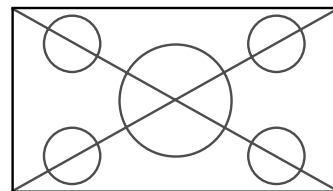

Information

■ Supported resolution

See page 55 for details on the display output of the various VESA signal standards supported by the monitor.

■ "PICTURE SIZE" setting

When the setting of "PICTURE SIZE" is OFF, the size of RGB-input pictures will be TRUE in place of NORMAL.

■ When 852 (848) dot × 480 line wide VGA* signals with a vertical frequency of 60 Hz and horizontal frequency of 31.7 (31.0) kHz are input

Select an appropriate setting for RGB SELECT mode referring to the "Table of Signals Supported" on page 55.

* "IBM PC/AT" and "VGA" are registered trademarks of IBM, Inc. of the United States.

MULTI SCREEN Operations

Showing a couple of pictures on the screen at the same time

* An RGB-input picture may not be displayed in these modes, depending on the input signal specifications.

1. Press the MULTI button to select a screen mode from among single mode, side by side, and picture in picture.

Side by side

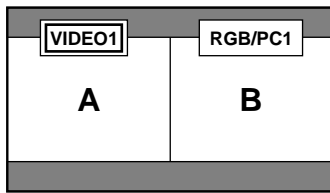

Note:

Picture A and B on the above screen are not always of the same height.

Picture in picture

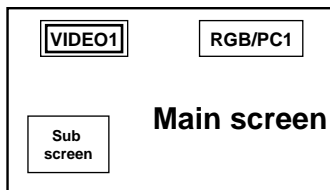

Information

Multi screen operations may not function depending on the combination of input signals. In the table below, "○" means Yes, "×" means No.

		Pictures displayed on the right/main screen							
		VIDEO1	VIDEO2	VIDEO3	HD/DVD1	HD/DVD2	RGB/PC1	RGB/PC2	RGB/PC3
Pictures displayed on the left/sub screen	VIDEO1	×	×	×	○	○	○	○	○
	VIDEO2	×	×	×	○	○	○	○	○
	VIDEO3	×	×	×	○	○	○	○	○
	HD/DVD1	○	○	○	×	○	○	○	○
	HD/DVD2	○	○	○	○	×	○	×	○
	RGB/PC1	○	○	○	○	○	×	×	×
	RGB/PC2	○	○	○	○	×	×	×	×
RGB/PC3	○	○	○	○	○	×	×	×	

■ Multi screen operations may not function depending on the type of the RGB signals.

Operations in the Side-by-side mode

To change the picture size, press the cursor ◀ or ▶ button.

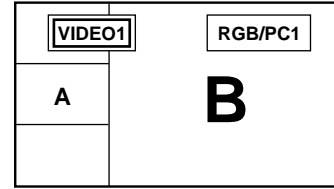

◀ button ↑ ↓ ▶ button

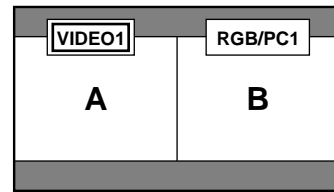

◀ button ↑ ↓ ▶ button

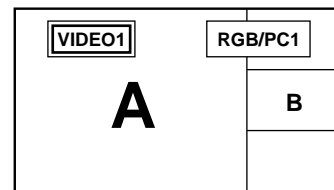

To swap the picture on the right and the left, press the cursor ▲ button.

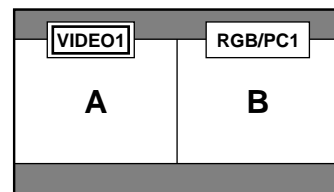

↕ ▲ button

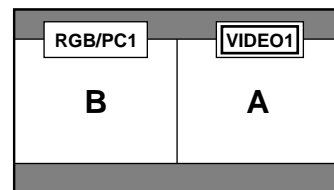

To make the desired picture active, press the SELECT button.

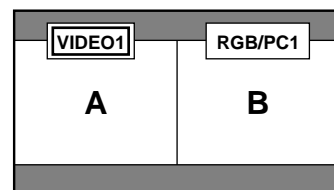

↕ SELECT button

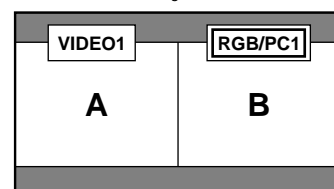

Operations in the Picture-in-picture mode

To move the position of the sub screen, press the cursor ◀ or ▶ button.

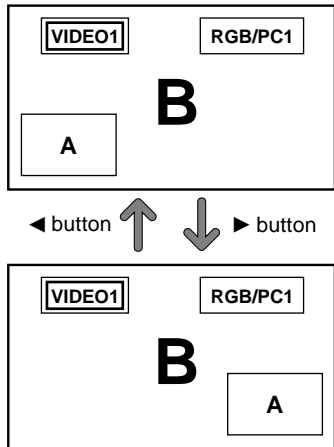

To change the size of the sub screen, press the ZOOM +/- button.

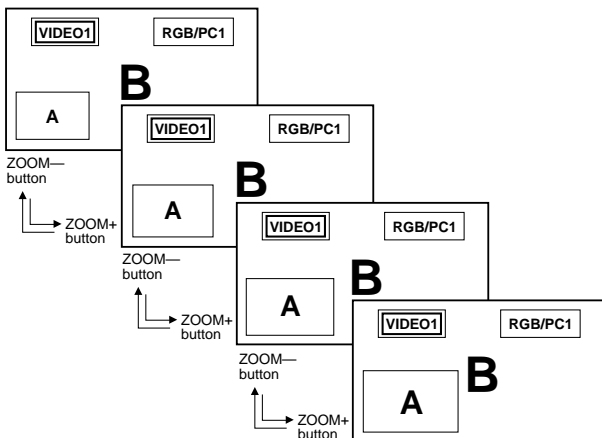

To make the desired picture active, press the SELECT button.

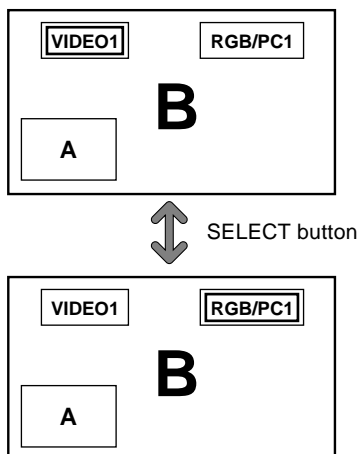

Selecting the input signals to be displayed

1. Press the SELECT button to make the desired picture active.
2. Press the RGB/PC, VIDEO, or DVD/HD button. Each press of the button changes the selection of the input signal. The INPUT SELECT button on the monitor can also be used to change the selection.

Adjusting the OSM controls

1. Press the SELECT button to make the desired picture active.
2. Press the PROCEED button to display the MAIN MENU.
3. Adjust the setting to your preference. For details, see “OSM (On Screen Menu) Controls” on page 18.

Note:

- During Multi screen mode, Auto Adjust does not affect the screen.
- During Multi screen mode, some functions of OSM controls are not available.

OSM(On Screen Menu) Controls

Menu Operations

The OSM window is displayed with respect to the screen as shown on the diagram.

* Depending on the screen's mode, the OSM may be displayed differently.

In the explanation, the OSM section is shown close up.



The following describes how to use the menus and the selected items.

1. Press the PROCEED button on the remote control to display the MAIN MENU.

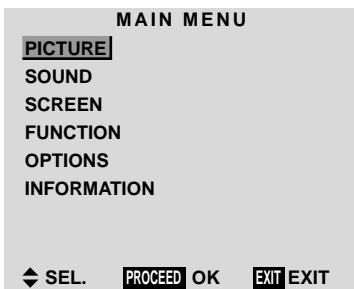

2. Press the cursor buttons ▲ ▼ on the remote control to highlight the menu you wish to enter.
3. Press the PROCEED button on the remote control to select a submenu or item.

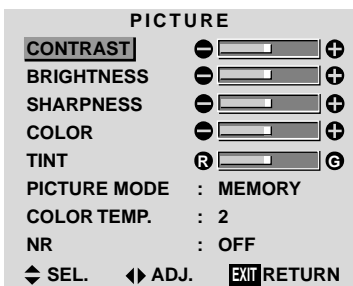

4. Adjust the level or change the setting of the selected item by using the cursor buttons ◀ ▶ on the remote control.

5. The adjustment or the setting which you stored is remained.

The change is stored until you change it again.

6. Repeat steps 2 – 5 to adjust an additional item, or press the EXIT button on the remote control to return to the main menu.

Note: The main menu disappears by pressing the EXIT button.

Main menu	Sub menu	Functions	Default	Reset
PICTURE	CONTRAST	Adjusts the contrast.	Center	Yes
	BRIGHTNESS	Adjusts the brightness.	Center	Yes
	SHARPNESS	Adjusts the sharpness.	Center/1	Yes
	COLOR	Adjusts the color.	Center	Yes
	TINT	Adjusts the tint.	Center	Yes
	PICTURE MODE	Sets the picture mode according to the VIDEO environment and image software.	MEMORY	Yes
	COLOR TEMP	Adjusts the color temperature and white balance.	2	Yes
	NR	Reduces noise visible in image.	OFF	Yes

Main menu	Sub menu	Functions	Default	Reset
SOUND	BASS	Sets the bass.	Center	Yes
	TREBLE	Sets the treble.	Center	Yes
	BALANCE	Sets the left/right balance.	Center	Yes

Main menu	Sub menu	Functions	Default	Reset
SCREEN	V-POSITION	Adjusts the vertical position.	Center	Yes
	H-POSITION	Adjusts the horizontal position.	Center	Yes
	V-HEIGHT	Adjusts the vertical size.	Min	Yes
	H-WIDTH	Adjusts the horizontal size.	Min	Yes
	AUTO PICTURE	Turn this on to have the monitor automatically adjust "FINE PICTURE" and "PICTURE ADJ".	OFF*1	No
	FINE PICTURE	Adjusts for flickering on the computer image.	Min*1	Yes
	PICTURE ADJ.	Adjusts for striped patterns on the computer image.	Center*1	Yes

Main menu	Sub menu	Functions	Default	Reset
FUNCTION	OSM	Turns the on-screen menu (screen mode, etc.) off (when set to "OFF"). When set to "ON", the on-screen menu is displayed.	ON	Yes
	OSM ADJ.	Adjusts the vertical and horizontal positions of the menu display.	1	Yes
	POWER MGT	Sets the monitor for use as an energy-saving display when used with a computer.	OFF	Yes
	GRAY LEVEL	In case of 4 : 3, sets the luminance of both sides.	3	Yes
	CINEMA MODE	Sets the picture to suit the movie.	ON	Yes
	RGB3 ADJ.	Adjusts the picture when the picture input from the RGB3 input terminal is distorted.	1	Yes
	LONG LIFE	Sets the picture to reduce burn-in of the display.	*2	Yes
	RESET	Resets all the settings (PICTURE, SOUND, SCREEN, FUNCTION, etc.) to the factory default values.	—	—

Main menu	Sub menu	Functions	Default	Reset
OPTIONS	AUDIO INPUT	Sets the allocation of the audio connectors.	*3	Yes
	BNC SELECT	Sets the BNC connectors.	RGB	Yes
	RGB SELECT	Sets the appropriate mode for the computer image. RGB (VGA signals), VIDEO (Moving picture), WIDE (WIDE VGA) DTV.	AUTO	Yes
	HD SELECT	Sets the digital broadcasting (1080A,1080B) or the High Vision (1035I).	1080B	No
	PICTURE SIZE	Sets the picture size for RGB input.	ON	Yes

Main menu	Sub menu	Functions	Default	Reset
INFORMATION	FREQUENCY	Used to check the frequency and synchronizing polarities of the signal currently being inputted.	—	—
	LANGUAGE	Sets the language of the menus (Japanese, English, German, French, Swedish, Italian or Spanish).	English	No
	COLOR SYSTEM	Sets the VIDEO format (AUTO1, AUTO2, PAL, PAL-M, PAL-N, PAL60, SECAM, 4.43 NTSC or 3.58 NTSC).	AUTO1	No

*1 RGB/PC only.

*2 PLE: AUTO ORBITER: OFF INVERSE: OFF SCREEN WIPER: OFF

*3 AUDIO1: VIDEO1 AUDIO2: HD/DVD1 AUDIO3: RGB1

Picture Settings Menu

Adjusting the picture

The contrast, brightness, sharpness, color and tint can be adjusted as desired.

Example: Adjusting the contrast

Press the **PROCEED** button on the remote control to display the **MAIN MENU** on the screen, then...

1. Use the ▲ and ▼ buttons to select “PICTURE”, then press the **PROCEED** button. The “PICTURE” screen appears.
2. Use the ▲ and ▼ buttons to select “CONTRAST”.

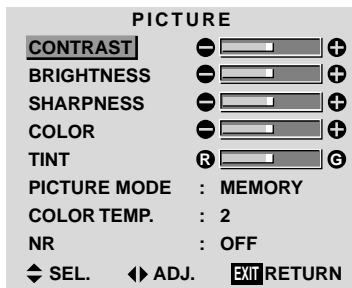

3. Use the ◀ and ▶ buttons to adjust the contrast.

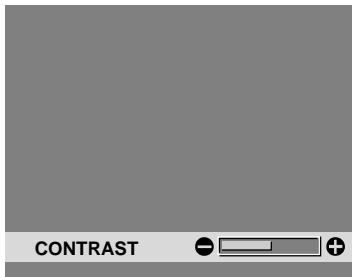

* If neither the ◀ or ▶ button is pressed within 5 seconds, the current setting is set and the previous screen reappears.

4. Once the adjustment is completed ...

Press the **EXIT** button to return to the main menu.

To delete the main menu, press the **EXIT** button once more.

Note: If “CAN NOT ADJUST” appears ...
When trying to enter the **PICTURE** submenu, make sure **PICTURE MODE** is set to **MEMORY**.

Information

■ Picture adjustment screen

CONTRAST Changes the picture’s contrast.

BRIGHTNESS .. Changes the picture’s brightness.

SHARPNESS .. Changes the picture’s sharpness.
Adjusts picture detail of VIDEO display.

COLOR Changes the color density.

TINT Changes the picture’s tint. Adjust for natural colored skin, background, etc.

■ Adjusting the computer image

Only the contrast and brightness can be adjusted when a computer signal is connected.

■ Restoring the factory default settings

Select “**RESET**” under the “**PICTURE MODE**” settings.

Setting the picture mode according to the brightness of the room

There are four picture modes that can be used effectively according to the environment in which you are viewing the display.

Example: Setting the "THEATER" mode

Press the *PROCEED* button on the remote control to display the *MAIN MENU* on the screen, then...

1. Use the ▲ and ▼ buttons to select "PICTURE", then press the *PROCEED* button.

The "PICTURE" screen appears.

2. Use the ▲ and ▼ buttons to select "PICTURE MODE".

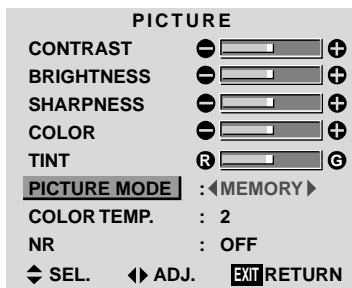

3. To set to "THEATER" ...

Use the ◀ and ▶ buttons to select "THEATER".

The mode switches as follows when the ◀ and ▶ buttons are pressed:

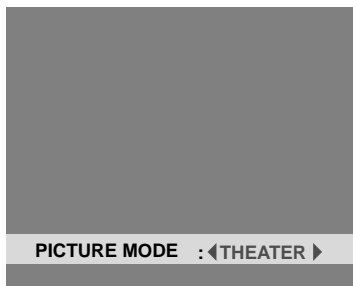
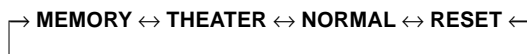

* If neither the ◀ or ▶ button is pressed within 5 seconds, the current selection is set and the previous screen reappears.

4. Once the adjustment is completed ...

Press the *EXIT* button to return to the main menu. To delete the main menu, press the *EXIT* button once more.

Information

Types of picture modes

MEMORY The last picture adjustments are stored here.

THEATER Set this mode when watching video in a dark room.

This mode provides darker, finer pictures, like the screen in movie theaters.

CONTRAST = 80% for RESET mode
BRIGHTNESS = 95% for RESET mode

NORMAL Set this mode when watching video in a bright room.

This mode provides dynamic pictures with distinct differences between light and dark sections.

CONTRAST = 96% for RESET mode

RESET Use this to reset the picture to the factory default settings.

Setting the color temperature

Use this procedure to set color tone produced by the plasma display.

Example: Setting "1"

Press the *PROCEED* button on the remote control to display the *MAIN MENU* on the screen, then...

1. Use the ▲ and ▼ buttons to select "PICTURE", then press the *PROCEED* button.
The "PICTURE" screen appears.
2. Use the ▲ and ▼ buttons to select "COLOR TEMP.".

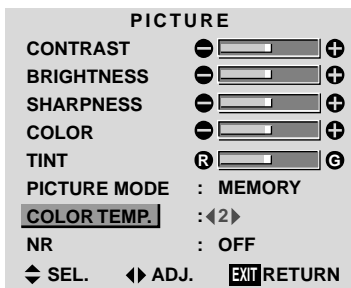

3. Use the ◀ and ▶ buttons to select "1".

The mode switches as follows when the ◀ and ▶ buttons are pressed:

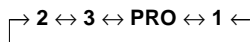

* See page 23 to set "PRO".

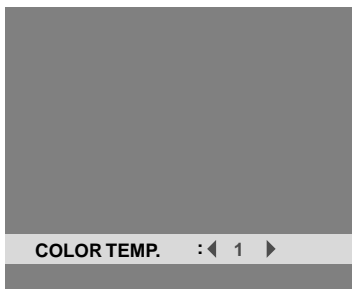

* If neither the ◀ or ▶ button is pressed within 5 seconds, the current selection is set and the previous screen reappears.

4. *Once the setting is completed...*

Press the *EXIT* button to return to the main menu.

To delete the main menu, press the *EXIT* button once more.

Information

■ Setting the color temperature

- 1 High (bluer)
- 2 Middle (Standard)
- 3 Low (redder)

■ Restoring the factory default settings

Select "RESET" under the function menu. Note that this also restores other settings to the factory defaults.

Adjusting the color to the desired quality

Use this procedure to adjust the white balance for bright pictures and dark pictures to achieve the desired color quality.

Example: Adjusting the “WHITE BALANCE”

Press the *PROCEED* button on the remote control to display the *MAIN MENU* on the screen, then...

1. Use the ▲ and ▼ buttons to select “PICTURE”, then press the *PROCEED* button.
The “PICTURE” screen appears.
2. Use the ▲ and ▼ buttons to select “COLOR TEMP.”.

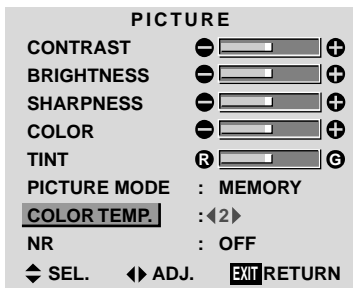

3. Use the ◀ and ▶ buttons to select “PRO”.

The mode switches as follows when the ◀ and ▶ buttons are pressed:

→ 2 ↔ 3 ↔ PRO ↔ 1 ←

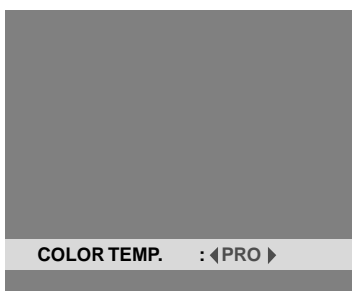

- * If neither the ◀ or ▶ button is pressed within 5 seconds, the current selection is set and the previous screen reappears.

4. Press the *PROCEED* button.
The “WHITE BALANCE” screen appears.
5. Use the ▲ and ▼ buttons to select “RED-GAIN”.

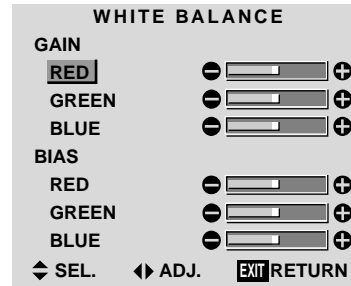

6. Adjust the white balance using the ◀ and ▶ buttons.

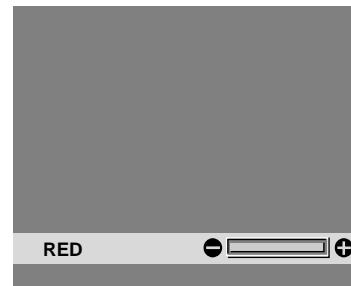

- * If neither the ◀ or ▶ button is pressed within 5 seconds, the current setting is set and the previous screen reappears.

7. Once the adjustment is completed...

Press the *EXIT* button several times to return to the main menu. To delete the main menu, press the *EXIT* button once more.

Information

■ Adjusting the white balance

RGB-GAIN White balance adjustment for signal level

RGB-BIAS White balance adjustment for black level

■ Restoring the factory default settings

Select “RESET” under the function menu. Note that this also restores other settings to the factory defaults.

Reducing noise in the picture

Use these settings if the picture has noise due to poor reception or when playing video tapes on which the picture quality is poor.

Example: Setting "NR-3"

Press the **PROCEED** button on the remote control to display the **MAIN MENU** on the screen, then...

1. Use the ▲ and ▼ buttons to select "PICTURE", then press the **PROCEED** button.
The "PICTURE" screen appears.
2. Use the ▲ and ▼ buttons to select "NR".

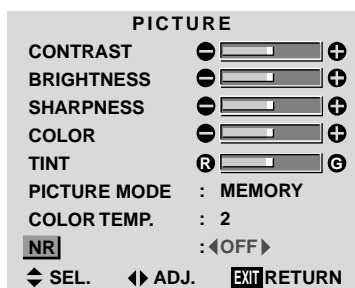

3. Use the ◀ and ▶ buttons to select "NR-3".
The mode switches as follows when the ◀ and ▶ buttons are pressed:

→ OFF ↔ NR-1 ↔ NR-2 ↔ NR-3 ←



* If neither the ◀ or ▶ button is pressed within 5 seconds, the current selection is set and the previous screen reappears.

4. *Once the setting is completed ...*

Press the **EXIT** button to return to the main menu.

To delete the main menu, press the **EXIT** button once more.

Information

■ NR

* "NR" stands for Noise Reduction.

* This function reduces noise in the picture.

■ Types of noise reduction

There are three types of noise reduction. Each has a different level of noise reduction.

The effect becomes stronger as the number increases (in the order NR-1 → NR-2 → NR-3).

OFF Turns the noise reduction function off.

Sound Settings Menu

Adjusting the treble, bass and left/right balance

The treble, bass and left/right balance can be adjusted to suit your tastes.

Example: Adjusting the bass

Press the **PROCEED** button on the remote control to display the **MAIN MENU** on the screen, then...

1. Use the ▲ and ▼ buttons to select “**SOUND**”, then press the **PROCEED** button.
The “**SOUND**” screen appears.
2. *To adjust the bass ...*
Use the ▲ and ▼ buttons to select “**BASS**”.

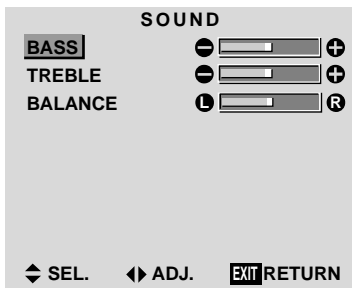

3. Adjust the bass using the ◀ and ▶ buttons.

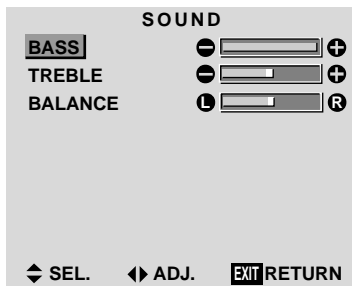

* If neither the ◀ or ▶ button is pressed within 5 seconds, the current selection is set and the previous screen reappears.

To continue adjusting the sound ...

Repeat from step 2.

4. *Once the adjustment is completed ...*

Press the **EXIT** button to return to the main menu. To delete the main menu, press the **EXIT** button once more.

Note : If “**CAN NOT ADJUST**” appears...
Set “**AUDIO INPUT**” on the **OPTION** menu correctly.

Information

■ Sound settings menu

BASS Controls the level of low frequency sound.

TREBLE Controls the level of high frequency sound.

BALANCE Controls the balance of the left and right channels.

■ Restoring the factory default settings

Select “**RESET**” under the function menu. Note that this also restores other settings to the factory defaults.

Screen Settings Menu

Adjusting the Position, Size, Fine Picture, Picture Adj

The position of the image can be adjusted and flickering of the image can be corrected.

Example: Adjusting the vertical position in the normal mode

Press the **PROCEED** button on the remote control to display the **MAIN MENU** on the screen, then...

1. Use the **▲** and **▼** buttons to select “**SCREEN**”, then press the **PROCEED** button. The “**SCREEN**” menu appears.

Default settings (when RGB/PC is selected)

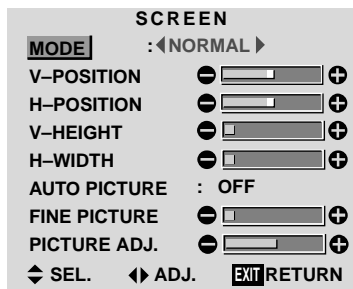

* The settings on the **SCREEN** menu are not preset at the factory.

To select a mode ...

Use the **◀** and **▶** buttons to select a mode.

The mode switches as follows when the **◀** and **▶** buttons are pressed:

→ **NORMAL** ↔ **FULL** ←

* The mode can also be switched by pressing the “**WIDE**” button on the remote control.

2. To adjust the vertical position ...

Use the **▲** and **▼** buttons to select “**V-POSITION**”.

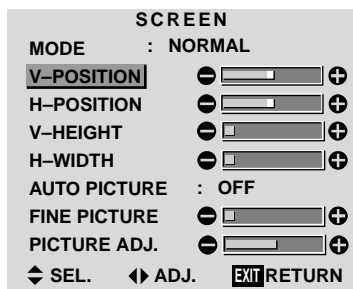

3. Adjust using the **◀** and **▶** buttons.

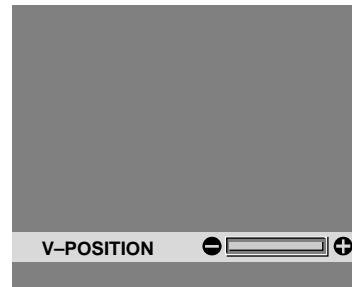

* If neither the **◀** or **▶** button is pressed within 5 seconds, the current setting is set and the previous screen reappears.

To continue making other computer image adjustments ...

Repeat from step 2.

4. Once all adjustments are completed ...

Press the **EXIT** button to return to the main menu.

To delete the main menu, press the **EXIT** button once more.

Information

■ When “**AUTO PICTURE**” is “**OFF**”

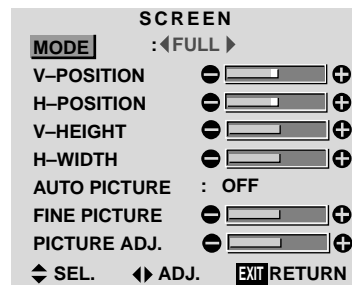

When Auto Picture is off, the Fine Picture and the Picture Adj. items are displayed so that you can adjust them.

Information

■ Adjusting the Auto Picture

ON The Picture ADJ and Fine Picture adjustments are made automatically.

OFF The Picture ADJ and Fine Picture adjustments are made manually.

■ Adjusting the position of the image

V-POSITION ... Adjusts the vertical position of the image.

H-POSITION ... Adjusts the horizontal position of the image.

V-HEIGHT Adjusts the vertical size of the image. (Except for STADIUM mode)

H-WIDTH Adjusts the horizontal size of the image. (Except for STADIUM mode)

FINE PICTURE* .. Adjusts for flickering.

PICTURE ADJ* ... Adjusts for striped patterns on the image.

* The Picture ADJ and Fine Picture features are available only when the "Auto Picture" is off.

* The AUTO PICTURE, FINE PICTURE and PICTURE ADJ. are available only for RGB signals.

■ Restoring the factory default settings

Select "RESET" under the function menu. Note that this also restores other settings to the factory defaults except for Auto Picture.

Function Settings Menu

Setting the on-screen menu

When using the monitor for presentations, etc., the monitor can be set so that the input source, screen mode, etc., do not appear.

Example: Turning the on-screen menu mode off

Press the *PROCEED* button on the remote control to display the *MAIN MENU* on the screen, then...

1. Use the ▲ and ▼ buttons to select "FUNCTION", then press the *PROCEED* button. The "FUNCTION" screen appears.
2. Use the ▲ and ▼ buttons to select "OSM".

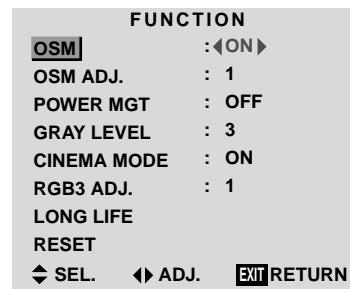

3. To turn the on-screen menu mode off... Use the ◀ and ▶ buttons to select "OFF". The mode switches as follows each time the ◀ or ▶ button is pressed:

ON ↔ OFF

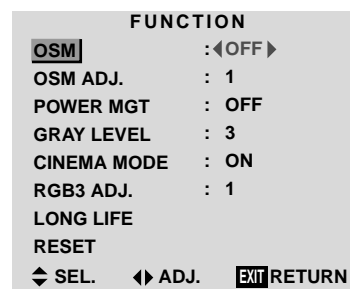

4. Once the setting is completed ... Press the *EXIT* button to return to the main menu. To delete the main menu, press the *EXIT* button once more.

Information

■ OSM modes

ON The on-screen menu appears.

OFF The on-screen menu does not appear.

■ Restoring the factory default settings

Select "RESET" under the function menu. Note that this also restores other settings to the factory defaults.

Adjusting the position of the menu display

Use these operations to adjust the position of the menus that appear on the screen.

Example: Adjusting the position of the menu display

Press the **PROCEED** button on the remote control to display the **MAIN MENU** on the screen, then...

1. Use the **▲** and **▼** buttons to select “**FUNCTION**”, then press the **PROCEED** button. The “**FUNCTION**” menu appears.
2. Use the **▲** and **▼** buttons to select “**OSM ADJ.**”

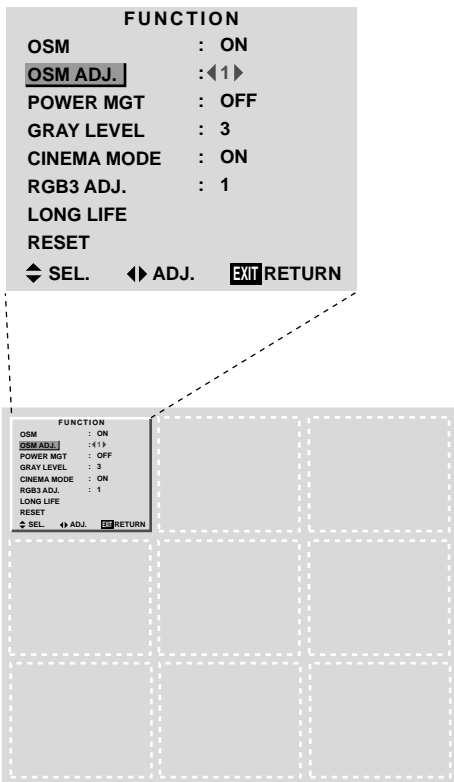

3. To adjust the position...
Adjust using the **◀** and **▶** buttons.

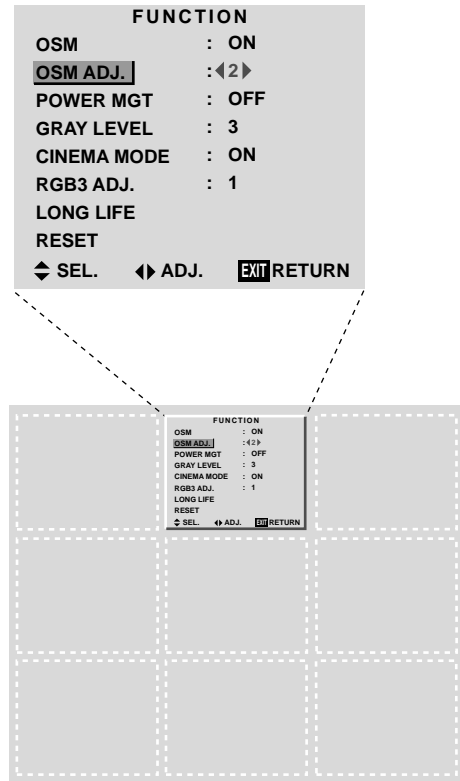

4. Once all adjustments are completed ...
Press the **EXIT** button to return to the main menu.
To delete the main menu, press the **EXIT** button once more.

Information

■ Adjusting the position of the menu display

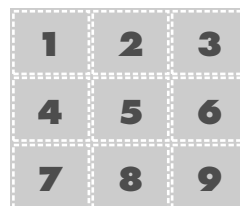

The position can be set between 1 and 9.

■ Restoring the factory default settings

Select “**RESET**” under the function menu. Note that this also restores other settings to the factory defaults.

Setting the power management for computer images

This energy-saving (power management) function automatically reduces the monitor's power consumption if no operation is performed for a certain amount of time.

Example: Turning the power management function on

Press the **PROCEED** button on the remote control to display the **MAIN MENU** on the screen, then...

1. Use the ▲ and ▼ buttons to select "FUNCTION", then press the **PROCEED** button.
The "FUNCTION" screen appears.
2. Use the ▲ and ▼ buttons to select "POWER MGT".

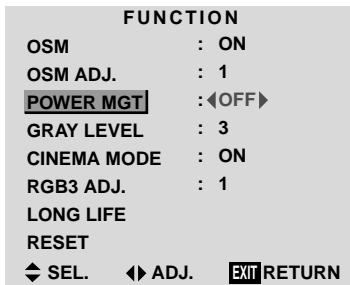

3. To turn the power management function on ...
Use the ◀ and ▶ buttons to select "ON".
The mode switches as follows each time the ◀ or ▶ button is pressed:
ON ↔ OFF

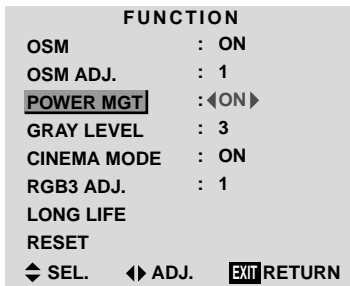

4. Once the setting is completed ...
Press the **EXIT** button to return to the main menu.
To delete the main menu, press the **EXIT** button once more.

Information

■ Power management function

- * The power management function automatically reduces the monitor's power consumption if the computer's keyboard or mouse is not operated for a certain amount of time. This function can be used when using the monitor with a computer conforming to the VESA DPMS format.
- * If the computer's power is not turned on or if the computer and selector tuner are not properly connected, the system is set to the off state.
- * For instructions on using the computer's power management function, refer to the computer's operating instructions.

■ Power management settings

- ON In this mode the power management function is turned on.
- OFF In this mode the power management function is turned off.

■ Power management function and POWER/STANDBY indicator

The POWER/STANDBY indicator indicates the status of the power management function. See page 30 for indicator status and description.

■ Restoring the factory default settings

Select "RESET" under the function menu. Note that this also restores other settings to the factory defaults.

POWER/STANDBY indicator

Power management mode	POWER/STANDBY indicator	Power management operating status	Description	Turning the picture back on
On	Green	Not activated.	Horizontal and vertical synchronizing signals are present from the computer.	Picture already on.
Standby	Orange	Activated.	No horizontal synchronizing signals are sent from the computer.	Operate the keyboard or mouse. The picture reappears immediately.
Suspend	Red	Activated.	No vertical synchronizing signals are sent from the computer.	Operate the keyboard or mouse. The picture reappears, but more time is required than from the standby mode.
Off	Red	Activated.	Neither horizontal nor vertical synchronizing signals are sent from the computer.	Operate the keyboard or mouse. The picture reappears, but more time is required than from the standby mode or suspend mode.

Setting the gray level for the sides of the screen

Use this procedure to set the gray level for the parts on the screen on which nothing is displayed when the screen is set to the 4:3 size.

Example: Adjusting the “GRAY LEVEL”

Press the *PROCEED* button on the remote control to display the *MAIN MENU* on the screen, then...

1. Use the ▲ and ▼ buttons to select “FUNCTION”, then press the *PROCEED* button.
The “FUNCTION” screen appears.
2. Use the ▲ and ▼ buttons to select “GRAY LEVEL”.

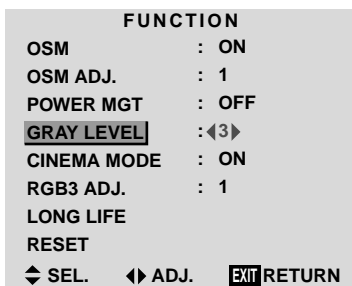

3. To adjust the “GRAY LEVEL”...
Use the ◀ and ▶ buttons to adjust the GRAY LEVEL.

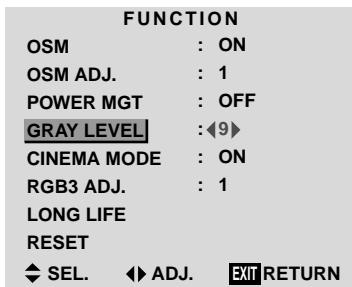

4. Once the setting is completed ...
Press the *EXIT* button to return to the main menu.
To delete the main menu, press the *EXIT* button once more.

Information

■ GRAY LEVEL

This adjusts the brightness of the black (the gray level) for the sides of the screen.
The standard is 0 (black). The level can be adjusted from 0 to 15. The factory setting is 3 (dark gray).

■ Restoring the factory default settings

Select “RESET” under the function menu. Note that this also restores other settings to the factory defaults.

Setting the picture to suit the movie

The film image is automatically discriminated and projected in an image mode suited to the picture.

[NTSC, PAL, PAL60, 480I (60Hz), 525I (60Hz), 576I (50Hz), 625I (50Hz), 1035I (60Hz), 1080I (60Hz) only]

Example: Setting the “CINEMA MODE” to “OFF”

Press the *PROCEED* button on the remote control to display the *MAIN MENU* on the screen, then...

1. Use the ▲ and ▼ buttons to select “FUNCTION”, then press the *PROCEED* button.
The “FUNCTION” screen appears.
2. Use the ▲ and ▼ buttons to select “CINEMA MODE”.

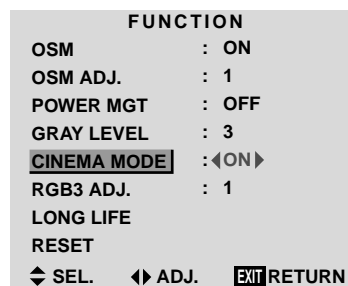

3. To set the *CINEMA MODE* to “OFF” ...
Use the ◀ and ▶ buttons to select “OFF”.
The mode switches as follows each time the ◀ or ▶ button is pressed:

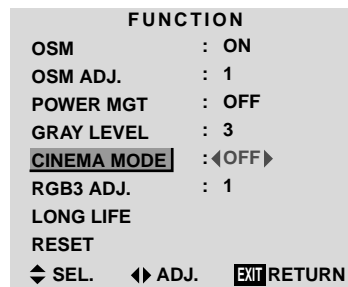
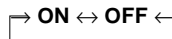

4. Once the setting is completed ...
Press the *EXIT* button to return to the main menu.
To delete the main menu, press the *EXIT* button once more.

Information

■ CINEMA MODE

ON Automatic discrimination of the image and projection in cinema mode.
OFF Cinema mode does not function.

■ Restoring the factory default settings

Select “RESET” under the function menu. Note that this also restores other settings to the factory defaults.

Setting RGB3 ADJ.

When the picture input from the RGB3 input terminal is distorted, select the most appropriate setting from among “1”, “2”, and “3”.

Example: Setting “2”

Press the **PROCEED** button on the remote control to display **MAIN MENU** on the screen, then...

1. Use the ▲ and ▼ buttons to select “FUNCTION”, then press the **PROCEED** button.
The “FUNCTION” screen appears.
2. Use the ▲ and ▼ buttons to select “RGB3 ADJ.”.

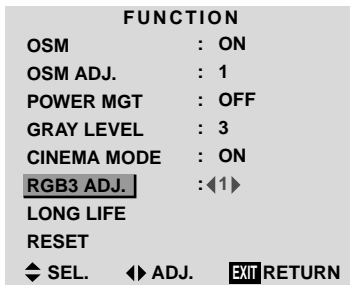

3. To select “2”...

Use the ◀ and ▶ buttons to select “2”.
The mode switches as follows each time the ◀ or ▶ button is pressed:

→ 1 ↔ 2 ↔ 3 ←

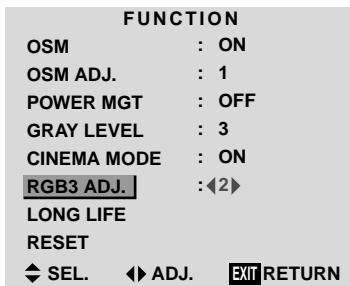

4. Once the setting is completed...

Press the **EXIT** button to return to the main menu.
To delete the main menu, press the **EXIT** button once more.

Information

■ When you adjust the RGB3 ADJ.

The position of the menu display will change. In such a case, be sure to adjust the position.

■ Restoring the factory default settings

Select “RESET” under the function menu. Note that this also restores other settings to the factory defaults.

Reducing burn-in of the screen

The brightness of the screen, the position of the picture, positive/negative mode and screen wiper are adjusted to reduce burn-in of the screen.

Example: Setting “PLE” to “LOCK”

Press the **PROCEED** button on the remote control to display the **MAIN MENU** on the screen, then proceed as follows.

1. Use the ▲ and ▼ buttons to select “FUNCTION”, then press the **PROCEED** button.
The “FUNCTION” screen appears.
2. Use the ▲ and ▼ buttons to select “LONG LIFE”, then press the **PROCEED** button.

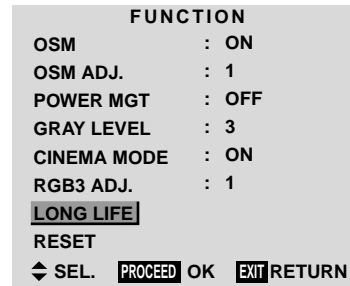

The “LONG LIFE” screen appears.

3. Use the ▲ and ▼ buttons to select “PLE”.

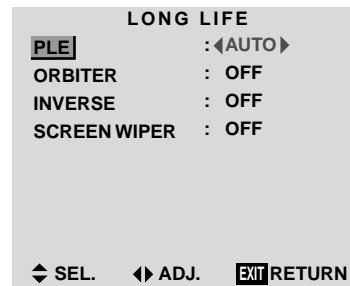

4. Use the ◀ and ▶ buttons to select “LOCK”.
The mode switches as follows each time the ◀ or ▶ button is pressed:

AUTO ↔ LOCK

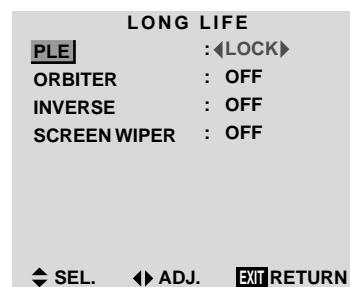

5. *Once the setting is completed...*

Press the EXIT button to return to the FUNCTION menu.

To exit the main menu, press the EXIT button twice.

Information

■ **PLE**

AUTO The brightness of the screen is adjusted automatically to suit the picture quality.

LOCK The brightness level is set to minimum.

■ **ORBITER**

OFF Orbiter mode does not function.

ON The picture moves around the screen intermittently.

■ **INVERSE**

OFF Inverse mode does not function.

ON The picture is displayed alternately between positive image and negative image.

You can set the time by pressing the PROCEED button while “ON” is set.

WT The entire screen turns white.

You can set the time by pressing the PROCEED button while “ON” is set.

■ **SCREEN WIPER**

OFF Screen wiper mode does not function.

ON Repeatedly moves the white vertical bar from the left end of the screen to the right end at a constant speed.

You can set the time by pressing the PROCEED button while “ON” is set.

■ **Restoring the factory default settings**

Select “RESET” from the function menu. Note that this also restores other settings to the factory defaults.

* Only the PLE and ORBITER can be adjusted when a RGB signal is connected.

Setting the time for “INVERSE”

Set the “INVERSE” or “WHITE” display time and the “WAITING TIME”.

Example: Setting so that the INVERSE mode starts in 30 minutes and proceeds for one and a half hours.

Perform Steps 1-2 on Page 32, then

3. Use the ▲ and ▼ buttons to select “INVERSE”, then use the ◀ and ▶ buttons to select “ON”.

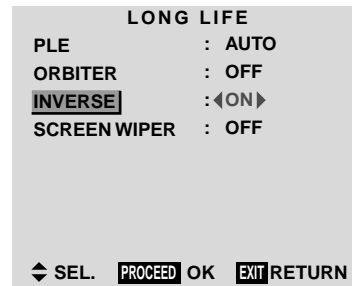

4. Press the PROCEED button. The “INVERSE/WT” screen appears.

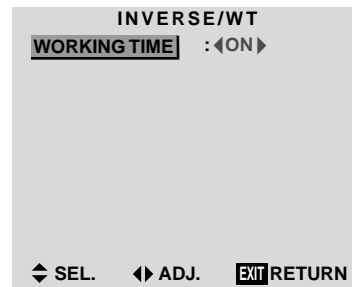

5. Adjust the time using the ◀ and ▶ buttons and the ▲ and ▼ buttons.

The mode switches as follows each time the ◀ or ▶ button is pressed.

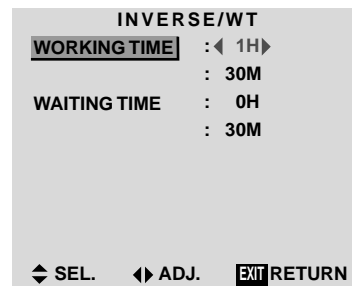

The 1st line of the “WORKING TIME”:

→ ON or 0H ↔ 1H ↔ 2H ↔ 3H ↔ ... ↔ 12H ←→

* The “WORKING TIME” (minutes) and “WAITING TIME” cannot be set when the “WORKING TIME” is “ON”.

The 2nd line of the “WORKING TIME”:

→ 0M ↔ 3M ↔ 6M ↔ 9M ↔ ... ↔ 57M ←

The 1st line of the “WAITING TIME”:

→ 0H ↔ 1H ↔ 2H ↔ 3H ↔ ... ↔ 12H ←

The 2nd line of the “WAITING TIME”:

→ 0M ↔ 3M ↔ 6M ↔ 9M ↔ ... ↔ 57M ←

6. *Once the setting is completed...*

Press the EXIT button several times to return to the main menu.

To delete the main menu, press the EXIT button once more.

Information

■ **Setting the time**

WORKING TIME

Set the length of time the “INVERSE/WT” mode lasts. When the WORKING TIME is set to “ON”, the “INVERSE/WT” mode stays in the on state.

WAITING TIME

Set the length of time until the “INVERSE/WT” mode starts.

* The “WORKING TIME” and “WAITING TIME” can be set for up to 12 hours and 45 minutes in units of 3 minutes.

■ **To select “ON” for the “WORKING TIME” ...**

Set the hours of the WORKING TIME to 0H and the minutes to 0M. “ON” will be displayed.

Setting the time for “SCREEN WIPER”

Set the “SCREEN WIPER” operation time, “WAITING TIME”, and “SPEED”.

Example: Setting so that the SCREEN WIPER mode starts in 30 minutes and proceeds for one and a half hours.

Perform Steps 1-2 on Page 32, then:

3. Use the ▲ and ▼ buttons to select “SCREEN WIPER”, then use the ◀ and ▶ buttons to select “ON”.

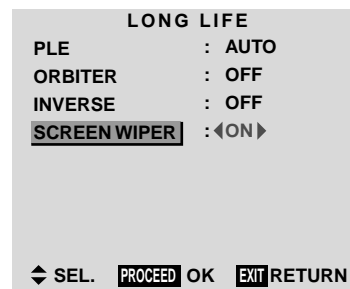

4. Press the PROCEED button. The “SCREEN WIPER” screen appears.

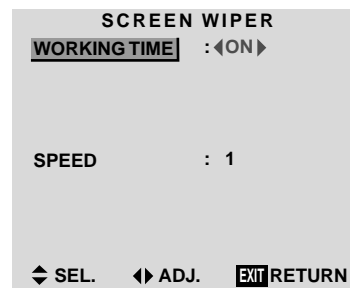

5. Adjust the time and speed using the ◀ and ▶ buttons and the ▲ and ▼ buttons. The mode switches as follows each time the ◀ and ▶ button is pressed.

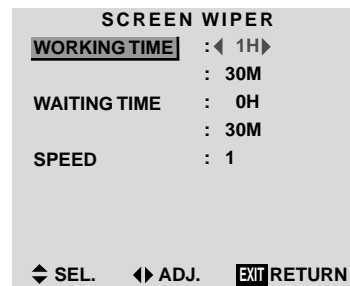

The 1st line of the “WORKING TIME”:

→ ON or 0H ↔ 1H ↔ 2H ↔ 3H ↔ ... ↔ 12H ←

* The “WORKING TIME” (minutes) and “WAITING TIME” cannot be set when the “WORKING TIME” is “ON”.

The 2nd line of the “WORKING TIME”:

→ 0M ↔ 3M ↔ 6M ↔ 9M ↔ ... ↔ 57M←

The 1st line of the “WAITING TIME”:

→ 0H ↔ 1H ↔ 2H ↔ 3H ↔ ... ↔ 12H←

The 2nd line of the “WAITING TIME”:

→ 0M ↔ 3M ↔ 6M ↔ 9M ↔ ... ↔ 57M←

“SPEED”:

→ 1↔ 2 ↔ 3 ↔ 4 ↔ 5←

6. *Once the setting is completed...*

Press the EXIT button several times to return to the main menu.

To delete the main menu, press the EXIT button once more.

Information

■ Setting the time

WORKING TIME

Set the length of time the “SCREEN WIPER” mode lasts.

When the WORKING TIME is set to “ON”, the “SCREEN WIPER” mode stays in the state.

WAITING TIME

Set the length of time until the “SCREEN WIPER” mode starts.

SPEED

Set the moving speed for the “SCREEN WIPER”. The speed decreases as the number increases.

* The “WORKING TIME” and “WAITING TIME” can be set for up to 12 hours and 45 minutes in units of 3 minutes.

■ To select “ON” for “WORKING TIME”...

Set the hours of the “WORKING TIME” to 0H and the minutes to 0M. “ON” will be displayed.

Resetting to the default values

Use these operations to restore all the picture adjustments, audio settings, to the factory default values. Refer to page 19 for items to be reset.

Press the PROCEED button on the remote control to display the MAIN MENU on the screen, then...

1. Use the ▲ and ▼ buttons to select “FUNCTION”, then press the PROCEED button.
The “FUNCTION” screen appears.
2. Use the ▲ and ▼ buttons to select “RESET”, then press the PROCEED button.

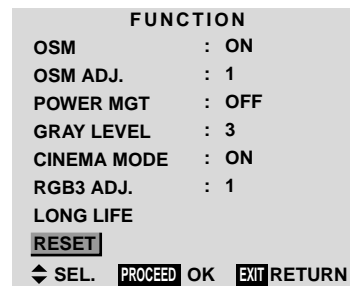

The “RESET” screen appears.

3. Use the ▲ and ▼ buttons to select “RESET”, then press the PROCEED button.

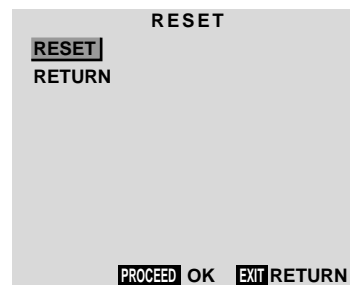

When the “SETTING NOW” screen disappears, the screen will be restored to the previous “RESET” mode, then all the settings are restored to the default values.

4. *Once the setting is completed ...*

Press the EXIT button.

To delete the main menu, press the EXIT button once more.

Options Settings Menu

Setting the allocation of the audio connectors

Setting the AUDIO 1, 2, and 3 connectors to the desired input.

Example: Setting "AUDIO 1" to "VIDEO 2"

Press the *PROCEED* button on the remote control to display the *MAIN MENU* on the screen, then...

1. Use the ▲ and ▼ buttons to select "OPTIONS", then press the *PROCEED* button.
The "OPTIONS" screen appears.
2. Use the ▲ and ▼ buttons to select "AUDIO 1".

OPTIONS	
AUDIO INPUT	
AUDIO1	: ◀ VIDEO1 ▶
AUDIO2	: HD/DVD1
AUDIO3	: RGB1
BNC SELECT	: RGB
RGB SELECT	: AUTO
HD SELECT	: 1080B
PICTURE SIZE	: ON
◀ SEL.	▶ ADJ. EXIT RETURN

3. To set the *AUDIO1* to "VIDEO2"...

Use the ◀ and ▶ buttons to select "VIDEO2".

The mode switches as follows each time the ◀ or ▶ button is pressed:

The mode switches as follows each time the ◀ or ▶ button is pressed:

The available sources depend on the setting of "BNC SELECT".

RGB: → VIDEO1 ↔ VIDEO2 ↔ VIDEO3 ↔ HD/DVD/DTV ←

COMP.: → VIDEO1 ↔ VIDEO2 ↔ VIDEO3 ↔ HD/DVD/DTV1 ←

OPTIONS	
AUDIO INPUT	
AUDIO1	: ◀ VIDEO2 ▶
AUDIO2	: HD/DVD1
AUDIO3	: RGB1
BNC SELECT	: RGB
RGB SELECT	: AUTO
HD SELECT	: 1080B
PICTURE SIZE	: ON
◀ SEL.	▶ ADJ. EXIT RETURN

4. Once the setting is completed...

Press the *EXIT* button to return to the main menu.

To delete the main menu, press the *EXIT* button once more.

Information

■ AUDIO INPUT

A single audio input cannot be selected as the audio channel for more than one input terminal.

■ Restoring the factory default settings

Select "RESET" under the function menu. Note that this also restores other settings to the factory defaults.

Setting the BNC connectors

Select whether to set the input of the 5 BNC connectors to RGB or component.

Example: Set the BNC SELECT mode to "COMP."

Press the *PROCEED* button on the remote control to display the *MAIN MENU* on the screen, then...

1. Use the ▲ and ▼ buttons to select "OPTIONS", then press the *PROCEED* button.
The "OPTIONS" screen appears.
2. Use the ▲ and ▼ buttons to select "BNC SELECT".

OPTIONS	
AUDIO INPUT	
AUDIO1	: VIDEO1
AUDIO2	: HD/DVD1
AUDIO3	: RGB1
BNC SELECT	: ◀ RGB ▶
RGB SELECT	: AUTO
HD SELECT	: 1080B
PICTURE SIZE	: ON
◀ SEL.	▶ ADJ. EXIT RETURN

3. To set the *BNC SELECT* mode to "COMP."...

Use the ◀ and ▶ buttons to select "COMP."

The mode switches as follows each time the ◀ or ▶ button is pressed:

→ RGB ↔ COMP. ←

OPTIONS	
AUDIO INPUT	
AUDIO1	: VIDEO1
AUDIO2	: HD/DVD1
AUDIO3	: RGB1
BNC SELECT	: ◀ COMP. ▶
RGB SELECT	: AUTO
HD SELECT	: 1080B
PICTURE SIZE	: ON
◀ SEL.	▶ ADJ. EXIT RETURN

4. Once the setting is completed...

Press the *EXIT* button to return to the main menu.

To delete the main menu, press the *EXIT* button once more.

Information

■ BNC SELECT

RGB Use the 5BNC terminal for RGB input.

COMP. Use the 3BNC terminal for component input.

■ Restoring the factory default settings

Select "RESET" under the function menu. Note that this also restores other settings to the factory defaults.

Setting a computer image to the correct RGB select screen

With the computer image, select the RGB Select mode for a moving image such as (video) mode, wide mode or digital broadcast.

Example: Setting the “RGB SELECT” mode to “MOTION”

Press the *PROCEED* button on the remote control to display the *MAIN MENU* on the screen, then...

- Use the ▲ and ▼ buttons to select “OPTIONS”, then press the *PROCEED* button.
The “OPTIONS” screen appears.
- Use the ▲ and ▼ buttons to select “RGB SELECT”.



- To set the RGB select mode to “MOTION” ...
Use the ◀ and ▶ buttons to select “MOTION”.
The mode switches as follows each time the ◀ or ▶ button is pressed:

→ AUTO ↔ STILL ↔ MOTION ↔ WIDE1 ↔ WIDE2 ↔ DTV ←



- Once the setting is completed ...
Press the *EXIT* button to return to the main menu.
To delete the main menu, press the *EXIT* button once more.

Information

■ RGB SELECT modes

One of these 6 modes must be selected in order to display the following signals correctly.

AUTO Select the suitable mode for the specifications of input signals as listed in the table “Computer input signals supported by this system” on page 55.

STILL To display VESA standard signals. (Use this mode for a still image from a computer.)

MOTION The video signal (from a scan converter) will be converted to RGB signals to make the picture more easily viewable. (Use this mode for a motion image from a computer.)

WIDE1 When an 852 dot × 480 line signal with a horizontal frequency of 31.7kHz is input, the image may be compressed horizontally. To prevent this, set RGB SELECT to WIDE1.

WIDE2 When an 848 dot × 480 line signal with a horizontal frequency of 31.0 kHz is input, the image may be compressed horizontally. To prevent this, set RGB SELECT to WIDE2.

DTV Set this mode when watching digital broadcasting (480P).

See page 55 for the details of the above settings.

■ Restoring the factory default settings

Select “RESET” under the function menu. Note that this also restores other settings to the factory defaults.

Setting high definition images to the suitable screen size

Use this procedure to set whether the number of vertical lines of the input high definition image is 1035 or 1080.

Example: Setting the "1080B" mode to "1035I"

Press the **PROCEED** button on the remote control to display the **MAIN MENU** on the screen, then...

- Use the ▲ and ▼ buttons to select "OPTIONS", then press the **PROCEED** button. The "OPTIONS" screen appears.
- Use the ▲ and ▼ buttons to select "HD SELECT".

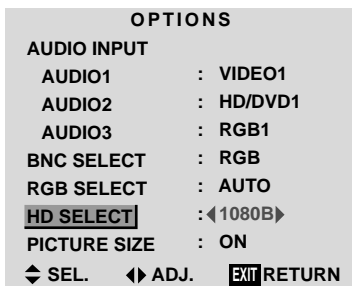

- To set the **HD SELECT** mode to "1035I" ... Use the ◀ and ▶ buttons to select "1035I". The mode switches as follows each time the ◀ or ▶ button is pressed:

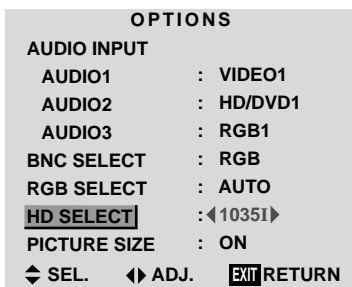
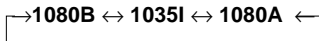

- Once the setting is completed ... Press the **EXIT** button to return to the main menu. To delete the main menu, press the **EXIT** button once more.

Information

■ HD SELECT modes

These 3 modes are not displayed in correct image automatically.

- 1080B Standard digital broadcasts
- 1035I Japanese "High Vision" signal format
- 1080A Special Digital broadcasts (for example : DTC100)

Setting the picture size for RGB input signals

Use this procedure to switch the setting to "ON" or "OFF".

Example: Setting the "ON" mode to "OFF"

Press the **PROCEED** button on the remote control to display the **MAIN MENU** on the screen, then...

- Use the ▲ and ▼ buttons to select "OPTIONS", then press the **PROCEED** button. The "OPTIONS" screen appears.
- Use the ▲ and ▼ buttons to select "PICTURE SIZE".

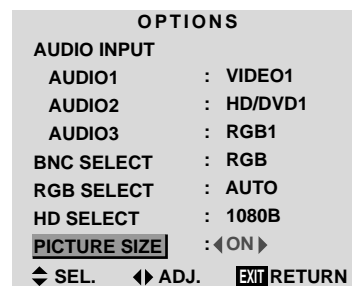

- To set **PICTURE SIZE** mode to "OFF" ... Use the ◀ and ▶ buttons to select "OFF". The mode switches as follows when the ◀ or ▶ buttons are pressed:
ON ↔ OFF



- Once the setting is completed ... Press the **EXIT** button to return to the main menu. To delete the main menu, press the **EXIT** button once more.

Information

■ PICTURE SIZE

ON For RGB Input: "NORMAL" and "FULL" can be selected for Wide-Screen switching.

OFF For RGB Input: "TRUE" and "FULL" can be selected for Wide-Screen switching.

■ Restoring the factory default settings

Select "RESET" under the function menu. Note that this also restores other settings to the factory defaults.

Information Menu

Checking the frequencies, polarities of input signals, and resolution

Use this function to check the frequencies and polarities of the signals currently being input from a computer, etc.

Press the **PROCEED** button on the remote control to display the **MAIN MENU** on the screen, then...

1. Use the ▲ and ▼ buttons to select “**INFORMATION**”, then press the **PROCEED** button.
The “**INFORMATION**” screen appears.
2. Use the ▲ and ▼ buttons to select “**FREQUENCY**”, then press the **PROCEED** button.

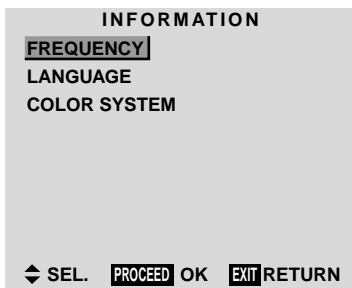

3. The frequency is displayed.

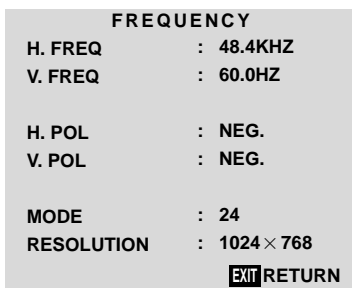

* Press the **EXIT** button to return to the previous screen.

4. *Once you have checked the frequency ...*
Press the **EXIT** button to return to the main menu.
To delete the main menu, press the **EXIT** button once more.

Setting the language for the menus

The menu display can be set to one of seven languages: Japanese, English, German, French, Swedish, Italian or Spanish.

Example: Setting the menu display to “**DEUTSCH**”

Press the **PROCEED** button on the remote control to display the **MAIN MENU** on the screen, then...

1. Use the ▲ and ▼ buttons to select “**INFORMATION**”, then press the **PROCEED** button. The “**INFORMATION**” screen appears.
2. Use the ▲ and ▼ buttons to select “**LANGUAGE**”, then press the **PROCEED** button.

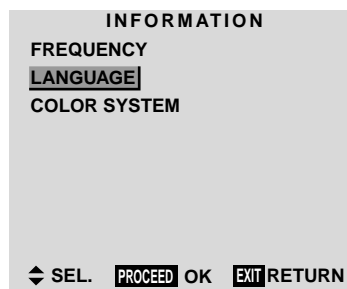

The “**LANGUAGE**” screen appears.

3. *To select “**DEUTSCH**” ...*

Use the ◀ and ▶ buttons to select “**DEUTSCH**”. The mode switches as follows when the ◀ and ▶ buttons are pressed:



4. Press the **PROCEED** button.
The display language is switched to Deutsch.
5. *Once the setting is completed ...*
Press the **EXIT** button to return to the main menu.
To delete the main menu, press the **EXIT** button once more.

Information

■ Language settings

ENGLISH English
 DEUTSCH German
 FRANÇAIS French
 ESPAÑOL Spanish
 ITALIANO Italian
 SVENSKA Swedish
 日本語 Japanese

Setting the video signal format

Use these operations to set the color systems of composite video signals or Y/C input signals.

Example: Setting the color system to “3.58 NTSC”

Press the **PROCEED** button on the remote control to display the **MAIN MENU** on the screen, then...

1. Use the ▲ and ▼ buttons to select “**INFORMATION**”, then press the **PROCEED** button.
The “**INFORMATION**” screen appears.
2. Use the ▲ and ▼ buttons to select “**COLOR SYSTEM**”, then press the **PROCEED** button.

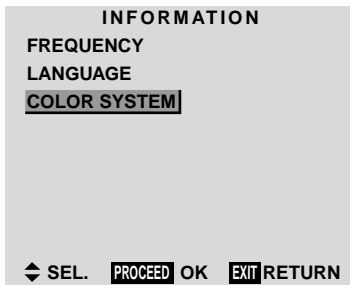

The “**COLOR SYSTEM**” screen appears.

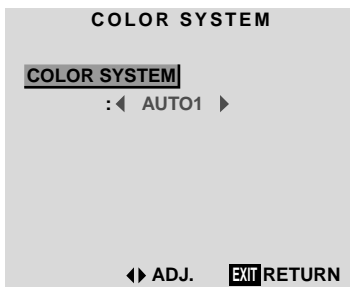

3. To select “3.58 NTSC” ...

Use the ◀ and ▶ buttons to select “3.58 NTSC”.
The mode switches as follows when the ◀ and ▶ buttons are pressed:

→ AUTO1 ↔ AUTO2 ↔ 3.58NTSC ↔ 4.43NTSC ←
→ SECAM ↔ PAL-M ↔ PAL-N ↔ PAL60 ↔ PAL ←

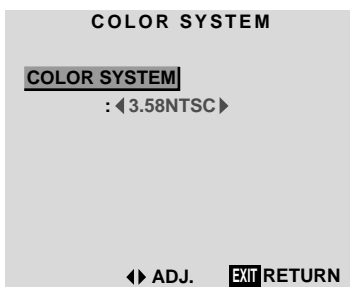

4. Once the setting is completed ...

Press the **EXIT** button to return to the main menu.
To delete the main menu, press the **EXIT** button once more.

The color system is set to “3.58 NTSC”.

Information

■ Video signal formats

Different countries use different formats for video signals. Set to the color system used in your current country.

AUTO1/2 The color systems are automatically identified and the format is set accordingly.

AUTO1: 3.58NTSC, 4.43NTSC, PAL, SECAM, PAL60

AUTO2: PAL-M, PAL-N, 3.58NTSC

PAL This is the standard format used mainly in the United Kingdom and Germany.

SECAM This is the standard format used mainly in France and Russia.

4.43 NTSC,

PAL60 This format is used for videos in countries using PAL and SECAM video signals.

3.58 NTSC This is the standard format used mainly in the United States and Japan.

PAL-M This is the standard format used mainly in Brazil.

PAL-N This is the standard format used mainly in Argentina.

External Control

Application

These specifications cover the communications control of the plasma monitor by external equipment.

Connections

Connections are made as described below.

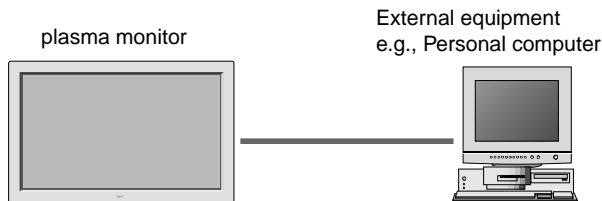

- 1) Connector on the plasma monitor side: EXTERNAL CONTROL connector.

Type of connector: D-Sub 9-pin male

No.	Pin Name
1	No Connection
2	RXD (Receive data)
3	TXD (Transmit data)
4	DTR (DTE side ready)
5	GND
6	DSR (DCE side ready)
7	RTS (Ready to send)
8	CTS (Clear to send)
9	No Connection

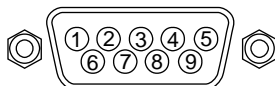

- 2) Connector on the external equipment side: Serial port (RS-232C) connector.

See the specifications of the equipment that is to be connected for the type of connector and the pin assignment.

- 3) Wiring

Use a crossed (reverse) cable.

Wire the cable so that each pair of data lines cross between the two devices. These data line pairs are RXD (Receive data) and TXD (Transmit data), DTR (DTE side ready) and DSR (DCE side ready), and RTS (Ready to send) and CTS (Clear to send).

Communication Parameters

(1) Communication system	Asynchronous
(2) Interface	RS-232C
(3) Baud rate	9600 bps
(4) Data length	8 bits
(5) Parity	Odd
(6) Stop bit	1 bit
(7) Communication code	Hex

Communication Format

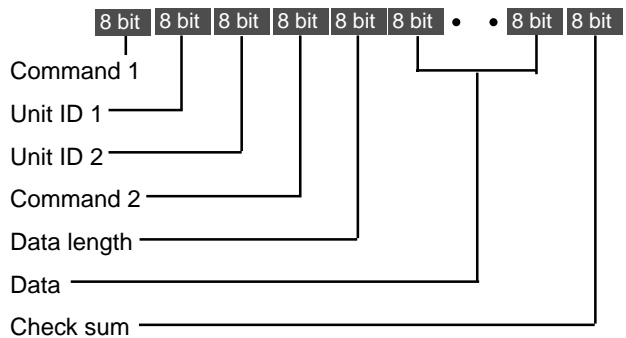

Command 1

Command 1, along with command 2, is a number used to distinguish each command.

In the case of ACK, when the lower order 4 bits is FH (as in 3FH and 7FH), this indicates that the commands and data of the supported equipment have been received. When the lower order 4 bits is BH (as in 3BH and 7BH), this indicates that unsupported commands and data have been received.

Unit ID 1 and Unit ID 2

Unit ID 1 and unit ID 2 are numbers used to identify the equipment that is to be connected.

60H is used for the plasma monitor and 80H is used for external control equipment such as a personal computer.

- 1) Unit ID 1: Indicates the equipment sending the signal
- 2) Unit ID 2: Indicates the equipment receiving the signal

Command 2

Command 2, along with command 1, is a number used to distinguish each command.

Check Sum (CKS), Error Processing, and ACK

- 1) The check sum described below and RS-232C odd parity are used together for a check of the received data.

The check sum is the lower order 8 bits of one frame of sent or received data comprising the sum total of Command 1, Unit ID 1 and 2, Command 2, Data Length, and Data.

Check Sum Example

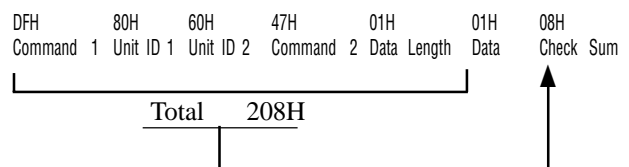

- 2) Error Processing

- When the communication interval is vacant for more than 4 ms, thereafter a received Command 1 will be recognized. If, at this time, meaningful data cannot be recognized, that data will not be recognized (as valid data).
- An ACK will not be returned unless the receive data error, the check sum error, and the receive data are all taken in.

Command Reference List

	CMD1	CMD2	LEN
01. Power ON	9FH	4EH	00H
02. Power OFF	9FH	4FH	00H
03. Input Switch Change	DFH	47H	01H
04. VOLUME Gain Data	DFH	7FH	03H
05. AUDIO Mute On	9FH	3EH	00H
06. AUDIO Mute Off	9FH	3FH	00H
07. CONTRAST Gain Data	DFH	7FH	03H
08. BRIGHT Gain Data	DFH	7FH	03H
09. SHARPNESS Gain Data	DFH	7FH	03H
10. Color Gain Data	DFH	7FH	03H
11. TINT Gain Data	DFH	7FH	03H
12. PICTURE MODE Select	DFH	0AH	01H
13. COLOR TEMP SELECT	DFH	00H	01H
14. RED Gain Data	DFH	7FH	04H
15. GREEN Gain Data	DFH	7FH	04H
16. BLUE Gain Data	DFH	7FH	04H
17. NR MODE Set	DFH	C0H	01H
18. BASS Gain Data	DFH	7FH	03H
19. TREBLE Gain Data	DFH	7FH	03H
20. BALANCE Gain Data	DFH	7FH	03H
21. SCREEN MODE Select	DFH	51H	01H
22. V. POSITION Gain Data	DFH	7FH	03H
23. H. POSITION Gain Data	DFH	7FH	03H
24. V-HEIGHT Gain Data	DFH	7FH	03H
25. H-WIDTH Gain Data	DFH	7FH	03H
26. AUTO PICTURE Select	DFH	7FH	03H
27. PHASE Gain Data	DFH	7FH	03H
28. CLOCK Gain Data	DFH	7FH	03H
29. OSM Select	DFH	58H	01H
30. OSM ADJ. Gain Data	DFH	1AH	02H
31. POWER MGT Select	DFH	1AH	02H
32. GRAY LEVEL Set	DFH	C6H	01H
33. CINEMA MODE Set	DFH	C1H	01H
34. RGB3 ADJ. Select	DFH	1AH	02H
35. LONG LIFE Set	DFH	6BH	03H
36. INVERSE Set	DFH	C7H	03H
37. SCREEN WIPER Set	DFH	C8H	04H
38. RESET	1FH	54H	00H
39. Audio Select Set	DFH	70H	02H
40. BNC SELECT	DFH	8CH	01H
41. RGB Select	DFH	8BH	01H
42. HD Select	DFH	8AH	01H
43. PICTURE SIZE Select	DFH	2AH	01H
44. LANGUAGE Select	DFH	5BH	01H
45. COLOR SYSTEM Select	DFH	5CH	01H
46. Multi Screen Select	DFH	07H	01H
47. FREQUENCY Request	1FH	26H	00H
48. Input MODE Request	1FH	41H	00H
49. VIDEO ADJ Request	1FH	45H	00H
50. Audio Select Request	1FH	6FH	00H
51. Failure Mode Request	1FH	3FH	00H
52. MODEL NAME Request	1FH	17H	00H

01. Power ON

Function

The external control equipment switches on the power of the plasma monitor.

Transmission Data

9FH 80H 60H 4EH 00H CKS

ACK

The plasma monitor returns the following ACK when the power is switched on.

3FH 60H 80H 4EH 00H CKS

NOTE: Do not set the Power ON or Power OFF command continuously.

02. Power OFF

Function

The external control equipment switches off the power of the plasma monitor.

Transmission Data

9FH 80H 60H 4FH 00H CKS

ACK

The plasma monitor returns the following ACK when the power is switched off.

3FH 60H 80H 4FH 00H CKS

NOTE: Do not set the Power ON or Power OFF command continuously.

03. Input Switch Change

Function

The external control equipment switches the input of the plasma monitor.

Transmission Data

DFH 80H 60H 47H 01H DATA00 CKS

DATA00: Input Select	01H: Video1
	02H: Video2
	03H: Video3
	05H: HD (HD1 or DTV or DTV1)
	06H: HD2 (DTV2)
	07H: RGB1/PC1
	08H: RGB2/PC2
	0CH: RGB3/PC3

ACK

The plasma monitor returns the following ACK when the input is switched.

3FH 60H 80H 47H 00H CKS

04. VOLUME Gain Data

Function

The external control equipment changes the VOLUME gain data of the plasma monitor.

Transmission Data

DFH	80H	60H	7FH	03H	DATA00	DATA01	DATA02	CKS
DATA00:					USER SOUND Gain Flag	05H		
DATA01:					VOLUME Gain Flag	01H		
DATA02:					VOLUME Gain	00H: Step 0		
						0AH: Step 10 (Default)		
						2AH: Step 42		

ACK

7FH	60H	80H	7FH	02H	DATA00	DATA01	CKS
DATA00:					USER SOUND Gain Flag	05H	
DATA01:					VOLUME Gain Flag	01H	

05. AUDIO Mute On

Function

The external control equipment switches on AUDIO Mute of the plasma monitor.

Transmission Data

9FH	80H	60H	3EH	00H	CKS

ACK

3FH	60H	80H	3EH	00H	CKS

06. AUDIO Mute Off

Function

The external control equipment switches off AUDIO Mute of the plasma monitor.

Transmission Data

9FH	80H	60H	3FH	00H	CKS

ACK

3FH	60H	80H	3FH	00H	CKS

07. CONTRAST Gain Data

Function

The external control equipment changes the CONTRAST gain data of the plasma monitor.

Transmission Data

DFH	80H	60H	7FH	03H	DATA00	DATA01	DATA02	CKS
DATA00:					USER PICTURE Gain Flag	01H		
DATA01:					CONTRAST Gain Flag	07H		
DATA02:					CONTRAST Gain	CCH : -52		
						FFH: -01		
						00H: 0		
						01H: +01		
						14H: +20		

ACK

7FH	60H	80H	7FH	02H	DATA00	DATA01	CKS
DATA00:					USER PICTURE Gain Flag	01H	
DATA01:					CONTRAST Gain Flag	07H	

08. BRIGHT Gain Data

Function

The external control equipment changes the BRIGHT gain data of the plasma monitor.

Transmission Data

DFH	80H	60H	7FH	03H	DATA00	DATA01	DATA02	CKS
DATA00:					USER PICTURE Gain Flag	01H		
DATA01:					BRIGHT Gain Flag	08H		
DATA02:					BRIGHT Gain	E0H: -32		
						FFH: -01		
						00H: 0		
						01H: +01		
						20H: +32		

ACK

7FH	60H	80H	7FH	02H	DATA00	DATA01	CKS
DATA00:					USER PICTURE Gain Flag	01H	
DATA01:					BRIGHT Gain Flag	08H	

09. SHARPNESS Gain Data

Function

The external control equipment changes the SHARPNESS gain data of the plasma monitor.

Transmission Data

DFH	80H	60H	7FH	03H	DATA00	DATA01	DATA02	CKS
DATA00:					USER PICTURE Gain Flag	01H		
DATA01:					SHARPNESS Gain Flag	06H		
DATA02:					SHARPNESS Gain	F0H: -16		
						FFH: -01		
						00H: 0		
						01H: +01		
						10H: +16		

Only when a RGB signal is connected

DATA02:					SHARPNESS Gain	01H: 1		
						02H: 2		
						03H: 3		
						04H: 4		
						05H: 5		

ACK

7FH	60H	80H	7FH	02H	DATA00	DATA01	CKS
DATA00:					USER PICTURE Gain Flag	01H	
DATA01:					SHARPNESS Gain Flag	06H	

10. COLOR Gain Data

Function

The external control equipment changes the COLOR gain data of the plasma monitor.

Transmission Data

DFH	80H	60H	7FH	03H	DATA00	DATA01	DATA02	CKS
DATA00:	USER PICTURE	Gain Flag			01H			
DATA01:	COLOR	Gain Flag			04H			
DATA02:	COLOR	Gain			E0H: -32			
* COLOR Gain is from -22 (EAH) to +22 (16H) only during video.								
					FFH: -01			
					00H: 0			
					01H: +01			
					20H: +32			

ACK

7FH	60H	80H	7FH	02H	DATA00	DATA01	CKS
DATA00:	USER PICTURE	Gain Flag			01H		
DATA01:	COLOR	Gain Flag			04H		

11. TINT Gain Data

Function

The external control equipment changes the TINT gain data of the plasma monitor.

Transmission Data

DFH	80H	60H	7FH	03H	DATA00	DATA01	DATA02	CKS
DATA00:	USER PICTURE	Gain Flag			01H			
DATA01:	TINT	Gain Flag			05H			
DATA02:	TINT	Gain			E0H: -32			
* TINT Gain is from -22 (EAH) to +22 (16H) only during video.								
					FFH: -01			
					00H: 0			
					01H: +01			
					20H: +32			

ACK

7FH	60H	80H	7FH	02H	DATA00	DATA01	CKS
DATA00:	USER PICTURE	Gain Flag			01H		
DATA01:	TINT	Gain Flag			05H		

12. PICTURE MODE Select

Function

The external control equipment sets the picture mode of the plasma monitor.

Transmission Data

DFH	80H	60H	0AH	01H	DATA00	CKS
DATA00:	01H:	MEMORY				
	02H:	THEATER				
	03H:	NORMAL				
	04H:	RESET				

ACK

7FH	60H	80H	0AH	01H	DATA00	CKS
DATA00:	01H:	MEMORY				
	02H:	THEATER				
	03H:	NORMAL				
	04H:	RESET				

13. COLOR TEMP SELECT

Function

The external control equipment changes the COLOR TEMP of the plasma monitor.

Transmission Data

DFH	80H	60H	00H	01H	DATA00	CKS
DATA00:	00H:	1				
	01H:	2				
	02H:	3				
	03H:	PRO				

ACK

7FH	60H	80H	00H	01H	DATA00	CKS
DATA00:	00H:	1				
	01H:	2				
	02H:	3				
	03H:	PRO				

NOTE: Set so that at the selection of 1, 2, or 3 of COLOR TEMP change of the following R/G/B GAIN data cannot be accepted.

14. RED Gain Data

Function

The external control equipment changes the RED Gain Data of the plasma monitor. Note that this command can be accepted only when PRO is selected from COLOR TEMP.

Transmission Data

DFH	80H	60H	7FH	04H	DATA00 to DATA03	CKS
DATA00:	USER PICTURE	Gain Flag			01H	
DATA01:	RED	Gain Flag			01H	
DATA02:	RED	Gain 1 (Bias)			D8H: -40	
					FFH: -1	
					00H: 0	
					IEH: +30	
DATA03:	RED	Gain 2 (Drive)			D8H: -40	
					FFH: -1	
					00H: 0	
					IEH: +30	

ACK

7FH	60H	80H	7FH	02H	DATA00	DATA01	CKS
DATA00:	USER PICTURE	Gain Flag			01H		
DATA01:	RED	Gain Flag			01H		

15. GREEN Gain Data

Function

The external control equipment changes the GREEN Gain Data of the plasma monitor. Note that this command can be accepted only when PRO is selected from COLOR TEMP.

Transmission Data

DFH	80H	60H	7FH	04H	DATA00 to DATA03	CKS
DATA00:	USER PICTURE Gain Flag				01H	
DATA01:	GREEN Gain Flag				02H	
DATA02:	GREEN Gain 1 (Bias)				D8H: -40	
					FFH: -1	
					00H: 0	
					IEH: +30	
DATA03:	GREEN Gain2 (Drive)				D8H: -40	
					FFH: -1	
					00H: 0	
					IEH: +30	

ACK

7FH	60H	80H	7FH	02H	DATA00	DATA01	CKS
DATA00:	USER PICTURE Gain Flag				01H		
DATA01:	GREEN Gain Flag				02H		

16. BLUE Gain Data

Function

The external control equipment changes the BLUE Gain Data of the plasma monitor. Note that this command can be accepted only when PRO is selected from COLOR TEMP.

Transmission Data

DFH	80H	60H	7FH	04H	DATA00 to DATA03	CKS
DATA00:	USER PICTURE Gain Flag				01H	
DATA01:	BLUE Gain Flag				03H	
DATA02:	BLUE Gain1(Bias)				D8H:-40	
					FFH:-1	
					00H: 0	
					IEH: +30	
DATA03:	BLUE Gain2(Drive)				D8H: -40	
					FFH:-1	
					00H: 0	
					IEH:+30	

ACK

7FH	60H	80H	7FH	02H	DATA00	DATA01	CKS
DATA00:	USER PICTURE Gain Flag				01H		
DATA01:	BLUE Gain Flag				03H		

17. NR MODE Set

Function

The external control equipment sets the NR (Noise Reduction) mode of the plasma monitor.

Transmission Data

DFH	80H	60H	COH	01H	DATA00	CKS
DATA00:	01H: NR OFF					
	02H: NR-1					
	03H: NR-2					
	04H: NR-3					

ACK

7FH	60H	80H	COH	01H	DATA00	CKS
DATA00:	01H: NR OFF					
	02H: NR-1					
	03H: NR-2					
	04H: NR-3					

18. BASS Gain Data

Function

The external control equipment changes the BASS gain data of the plasma monitor.

Transmission Data

DFH	80H	60H	7FH	03H	DATA00	DATA01	DATA02	CKS
DATA00:	USER PICTURE Gain Flag				05H			
DATA01:	BASS Gain Flag				03H			
DATA02:	BASS Gain				F3H: -13			
					FFH: -01			
					00H: 0			
					01H: +01			
					0DH: +13			

ACK

7FH	60H	80H	7FH	02H	DATA00	DATA01	CKS
DATA00:	USER PICTURE Gain Flag				05H		
DATA01:	BASS Gain Flag				03H		

19. TREBLE Gain Data

Function

The external control equipment changes the TREBLE gain data of the plasma monitor.

Transmission Data

DFH	80H	60H	7FH	03H	DATA00	DATA01	DATA02	CKS
DATA00:	USER PICTURE Gain Flag				05H			
DATA01:	TREBLE Gain Flag				04H			
DATA02:	TREBLE Gain				F3H: -13			
					FFH: -01			
					00H: 0			
					01H: +01			
					0DH: +13			

ACK

7FH	60H	80H	7FH	02H	DATA00	DATA01	CKS
DATA00:	USER PICTURE Gain Flag				05H		
DATA01:	TREBLE Gain Flag				04H		

20. BALANCE Gain Data

Function

The external control equipment changes the BALANCE gain data of the plasma monitor.

Transmission Data

DFH	80H	60H	7FH	03H	DATA00	DATA01	DATA02	CKS
DATA00:	USER PICTURE	Gain Flag			05H			
DATA01:	BALANCE	Gain Flag			02H			
DATA02:	BALANCE	Gain			EAH: -22			
					FFH: -01			
					00H: 0			
					01H: +01			
					16H: +22			

ACK

7FH	60H	80H	7FH	02H	DATA00	DATA01	CKS
DATA00:	USER PICTURE	Gain Flag			05H		
DATA01:	BALANCE	Gain Flag			02H		

21. SCREEN MODE Select

Function

The external control equipment switches the screen mode of the plasma monitor.

Transmission Data

DFH	80H	60H	51H	01H	DATA00	CKS
DATA00:	02H:	STADIUM				
	03H:	ZOOM				
	04H:	NORMAL				
	05H:	FULL				
	06H:	TRUE (REAL)				

ACK

7FH	60H	80H	51H	01H	DATA00	CKS
DATA00:	02H:	STADIUM				
	03H:	ZOOM				
	04H:	NORMAL				
	05H:	FULL				
	06H:	TRUE (REAL)				

22. V. POSITION Gain Data

Function

The external control equipment changes the V. POSITION gain data of the plasma monitor.

Transmission Data

DFH	80H	60H	7FH	03H	DATA00	DATA01	DATA02	CKS
DATA00:	USER PICTURE	Gain Flag			03H			
DATA01:	V. POSITION	Gain Flag			01H			
DATA02:	V. POSITION	Gain			COH: -64			
					FFH: -01			
					00H: 0			
					01H: +01			
					40H: +64			

ACK

7FH	60H	80H	7FH	02H	DATA00	DATA01	CKS
DATA00:	USER PICTURE	Gain Flag			03H		
DATA01:	V. POSITION	Gain Flag			01H		

23. H. POSITION Gain Data

Function

The external control equipment changes the H. POSITION gain data of the plasma monitor.

Transmission Data

DFH	80H	60H	7FH	03H	DATA00	DATA01	DATA02	CKS
DATA00:	USER PICTURE	Gain Flag			03H			
DATA01:	H. POSITION	Gain Flag			02H			
DATA02:	H. POSITION	Gain			80H: -128			
					FFH: -01			
					00H: 0			
					01H: +01			
					7FH: +127			

ACK

7FH	60H	80H	7FH	02H	DATA00	DATA01	CKS
DATA00:	USER PICTURE	Gain Flag			03H		
DATA01:	H. POSITION	Gain Flag			02H		

24. V-HEIGHT Gain Data

Function

The external control equipment changes the V-HEIGHT gain data of the plasma monitor.

Transmission Data

DFH	80H	60H	7FH	03H	DATA00	DATA01	DATA02	CKS
DATA00:	USER PICTURE	Gain Flag			03H			
DATA01:	V-HEIGHT	Gain Flag			07H			
DATA02:	V-HEIGHT	Gain			00H: 0			
					40H: +64			

ACK

7FH	60H	80H	7FH	02H	DATA00	DATA01	CKS
DATA00:	USER PICTURE	Gain Flag			03H		
DATA01:	V-HEIGHT	Gain Flag			07H		

25. H-WIDTH Gain Data

Function

The external control equipment changes the H-WIDTH gain data of the plasma monitor.

Transmission Data

DFH	80H	60H	7FH	03H	DATA00	DATA01	DATA02	CKS
DATA00:	USER PICTURE	Gain Flag			03H			
DATA01:	H-WIDTH	Gain Flag			08H			
DATA02:	H-WIDTH	Gain			00H: 0			
					40H: +64			

ACK

7FH	60H	80H	7FH	02H	DATA00	DATA01	CKS
DATA00:	USER PICTURE	Gain Flag			03H		
DATA01:	H-WIDTH	Gain Flag			08H		

26. AUTO PICTURE Select

Function

The external control equipment switches on or off the AUTO PICTURE of the plasma monitor.

Transmission Data

DFH	80H	60H	7FH	03H	DATA00	DATA01	DATA02	CKS
DATA00:	USER PICTURE	Gain Flag			03H			
DATA01:	AUTO PICTURE	Select Flag			09H			
DATA02:	00H:	ON						
	01H:	OFF						

ACK

7FH	60H	80H	7FH	03H	DATA00	DATA01	DATA02	CKS
DATA00:	USER PICTURE	Gain Flag			03H			
DATA01:	AUTO PICTURE	Select Flag			09H			
DATA02:	00H:	ON						
	01H:	OFF						

27. PHASE Gain Data

Function

The external control equipment changes the PHASE gain data (Phase) of the plasma monitor.

Transmission Data

DFH	80H	60H	7FH	03H	DATA00	DATA01	DATA02	CKS
DATA00:	USER PICTURE	Gain Flag			03H			
DATA01:	PHASE	Gain Flag			03H			
DATA02:	PHASE	Gain			00H:	0		
						2CH:	+44	

ACK

7FH	60H	80H	7FH	02H	DATA00	DATA01	CKS
DATA00:	USER PICTURE	Gain Flag			03H		
DATA01:	PHASE	Gain Flag			03H		

28. CLOCK Gain Data

Function

The external control equipment changes the CLOCK gain data (ratio of frequency division) of the plasma monitor.

Transmission Data

DFH	80H	60H	7FH	03H	DATA00	DATA01	DATA02	CKS
DATA00:	USER PICTURE	Gain Flag			03H			
DATA01:	CLOCK	Gain Flag			04H			
DATA02:	CLOCK	Gain			00H:	-64		
						FFH:	-01	
						00H:	0	
						01H:	+01	
						40H:	+64	

ACK

7FH	60H	80H	7FH	02H	DATA00	DATA01	CKS
DATA00:	USER PICTURE	Gain Flag			03H		
DATA01:	CLOCK	Gain Flag			04H		

29. OSM Select

Function

The external control equipment switches on or off the on-screen menu (OSM) of the plasma monitor.

Transmission Data

DFH	80H	60H	58H	01H	DATA00	CKS
DATA00:	01H:	On-Screen	menu	On		
	02H:	On-Screen	menu	Off		

ACK

7FH	60H	80H	58H	01H	DATA00	CKS
DATA00:	01H:	On-Screen	menu	On		
	02H:	On-Screen	menu	Off		

On-Screen menu On/Off is equivalent to the OSM menu item under the FUNCTION menu.

*Operation is as described in the table below.

Operation	On-Screen Menu (OSM)			
	Display of items and adjustments on the menu		Volume display, input display, and screen size display	
	When screen menu is ON	When screen menu is OFF	When screen menu is ON	When screen menu is OFF
Remote control operation	Yes	Yes	Yes	No
Personal computer control operation	No	No	Yes	No

30. OSM ADJ. Gain Data

Function

The external control equipment sets the position of the OSM menu of the plasma monitor.

Transmission Data

DFH	80H	60H	1AH	02H	DATA00	DATA01	CKS
DATA00:	OSM ADJ. Gain Flag				02H		
DATA01:	01H: 1						
	09H: 9						

ACK

7FH	60H	80H	1AH	01H	DATA00	CKS
DATA00:	OSM ADJ. Gain Flag				02H	

31. POWER MGT Select

Function

The external control equipment switches on or off the POWER MANAGEMENT of the plasma monitor.

Transmission Data

DFH	80H	60H	1AH	02H	DATA00	DATA01	CKS
DATA00:	POWER MGT Select				03H		
DATA01:	01H: ON						
	02H: OFF						

ACK

7FH	60H	80H	1AH	02H	DATA00	DATA01	CKS
DATA00:	POWER MGT Select				03H		
DATA01:	01H: ON						
	02H: OFF						

32. GRAY LEVEL Set

Function

The external control equipment sets the GRAY LEVEL of the plasma monitor.

Transmission Data

DFH	80H	60H	C6H	01H	DATA00	CKS
DATA00:	GRAY LEVEL				00H: 0	
					0FH: 15	

ACK

7FH	60H	80H	C6H	01H	DATA00	CKS
DATA00:	GRAY LEVEL				00H: 0	
					0FH: 15	

33. CINEMA MODE Set

Function

The external control equipment switches on or off the CINEMA MODE of the plasma monitor.

Transmission Data

DFH	80H	60H	C1H	01H	DATA00	CKS
DATA00:	CINEMA MODE Set				01H: ON	
					02H: OFF	

ACK

7FH	60H	80H	C1H	01H	DATA00	CKS
DATA00:	CINEMA MODE Set				01H: ON	
					02H: OFF	

34. RGB3 ADJ. Select

Function

The external control equipment sets the RGB3 ADJUST of the plasma monitor.

Transmission Data

DFH	80H	60H	1AH	02H	DATA00	DATA01	CKS
DATA00:	RGB3 ADJ. Select				06H		
DATA01:	01H: 1						
	02H: 2						
	03H: 3						

ACK

7FH	60H	80H	1AH	02H	DATA00	DATA01	CKS
DATA00:	RGB3 ADJ. Select				06H		
DATA01:	01H: 1						
	02H: 2						
	03H: 3						

35. LONG LIFE Set

Function

The external control equipment sets the PLE, ORBITER, and INVERSE (inverse of image brightness) of the plasma monitor.

Transmission Data

DFH	80H	60H	6BH	03H	DATA00	DATA01	DATA02	CKS
DATA00:	PLE				01H: AUTO			
					02H: LOCK			
DATA01:	INVERSE				01H: ON			
					02H: OFF			
					03H: WHITE			
DATA02:	ORBITER (PICTURE SHIFT)				01H: ON			
					02H: OFF			

ACK

The plasma monitor returns the following ACK when setting the PLE, ORBITER, and INVERSE (inverse of image brightness):

3FH	60H	80H	6BH	00H	CKS
-----	-----	-----	-----	-----	-----

36. INVERSE Set

Function

The external control equipment sets the INVERSE (inverse of image brightness) and the WHITE of the plasma monitor.

Transmission Data

DFH	80H	60H	C7H	03H	DATA00	DATA01	DATA02	CKS
DATA00 :	INVERSE/WHITE				00H: No operation 01H: ON(INVERSE) 02H: OFF 03H: WHITE			
DATA01 :	WORKING TIME				00H: ON 01H: 03M (minutes) 02H: 06M (minutes) FFH: 12H (hours) and 45M (minutes)			
DATA02 :	WAITING TIME				01H: 03M (minutes) 02H: 06M (minutes) FFH: 12H (hours) and 45M (minutes)			

ACK

3FH	60H	80H	C7H	00H	CKS
-----	-----	-----	-----	-----	-----

NOTE: The WORKING TIME and the WAITING TIME can be set in units of 3 minutes.
Example: 03H=9 minutes
1EH=1 hour and 30 minutes

37. SCREEN WIPER Set

Function

The external control equipment sets the SCREEN WIPER of the plasma monitor.

Transmission Data

DFH	80H	60H	C8H	04H	DATA00 to	DATA03	CKS
DATA00 :	SCREEN WIPER				00H: No operation 01H: ON 02H: OFF		
DATA01 :	WORKING TIME				00H: ON 01H: 03M (minutes) 02H: 06M (minutes) FFH: 12H (hours) and 45M (minutes)		
DATA02 :	WAITING TIME				01H: 03M (minutes) 02H: 06M (minutes) FFH: 12H (hours) and 45M (minutes)		
DATA03 :	SPEED				01H: 1 05H: 5		

ACK

3FH	60H	80H	C8H	00H	CKS
-----	-----	-----	-----	-----	-----

NOTE: The WORKING TIME and the WAITING TIME can be set in units of 3 minutes.
Example: 03H=9 minutes
1EH=1 hour and 30 minutes

38. RESET

Function

The external control equipment resets the user adjustment of the plasma monitor.

Transmission Data

1FH	80H	60H	54H	00H	CKS
-----	-----	-----	-----	-----	-----

ACK

3FH	60H	80H	54H	00H	CKS
-----	-----	-----	-----	-----	-----

39. Audio Select Set

Function

The external control equipment sets combinations of audio and video inputs for the plasma monitor.

Transmission Data

DFH	80H	60H	70H	02H	DATA00	DATA01	CKS
DATA00:	AUDIO INPUT					01H: AUDIO 1 02H: AUDIO 2 03H: AUDIO 3	
DATA01:	VISUAL INPUT					01H: Video 1 02H: Video 2 03H: Video 3 05H:HD (HD1 or DTV or DTV1) 06H: HD2 (DTV2) 07H: RGB 1/ PC 1 08H: RGB 2/ PC 2 0CH: RGB 3/ PC 3	

ACK

The plasma monitor returns the following ACK when the input is switched.

3FH	60H	80H	70H	00H	CKS
-----	-----	-----	-----	-----	-----

* The plasma monitor returns "Not Available" when selecting the video input same as the one set at one of the AUDIO 1 to 3.

Example:

The plasma monitor returns "Not Available" when selecting the VIDEO1 for AUDIO2 or VIDEO3 after VIDEO1 has been set to AUDIO1.

40. BNC SELECT

Function

The external control equipment sets the BNC SELECT of the plasma monitor.

Transmission Data

DFH	80H	60H	8CH	01H	DATA00	CKS
DATA00 :	BNC SELECT			01H:	RGB	
				02H:	Component	

ACK

The plasma monitor returns the following ACK when setting the BNC SELECT:

7FH	60H	80H	8CH	01H	DATA00	CKS
DATA00 :	BNC SELECT			01H:	RGB	
				02H:	Component	

41. RGB Select

Function

The external control equipment sets the RGB SELECT of the plasma monitor.

Transmission Data

DFH	80H	60H	8BH	01H	DATA00	CKS
DATA00:	01H:	AUTO				
	02H:	STILL				
	03H:	MOTION				
	04H:	WIDE1				
	05H:	WIDE2				
	06H:	DTV				

ACK

7FH	60H	80H	8BH	01H	DATA00	CKS
DATA00:	01H:	AUTO				
	02H:	STILL				
	03H:	MOTION				
	04H:	WIDE1				
	05H:	WIDE2				
	06H:	DTV				

42. HD Select

Function

The external control equipment sets the HD SELECT of the plasma monitor.

Transmission Data

DFH	80H	60H	8AH	01H	DATA00	CKS
DATA00:	01H:	1035I				
	02H:	1080A				
	03H:	1080B				

ACK

7FH	60H	80H	8AH	01H	DATA00	CKS
DATA00:	01H:	1035I				
	02H:	1080A				
	03H:	1080B				

43. PICTURE SIZE Select

Function

The external control equipment sets the PICTURE SIZE SELECT of the plasma monitor.

Transmission Data

DFH	80H	60H	2AH	01H	DATA00	CKS
DATA00:	01H:	ON				
	02H:	OFF				

ACK

7FH	60H	80H	2AH	01H	DATA00	CKS
DATA00:	01H:	ON				
	02H:	OFF				

44. LANGUAGE Select

Function

The external control equipment sets the LANGUAGE SELECT of the plasma monitor.

Transmission Data

DFH	80H	60H	5BH	01H	DATA00	CKS
DATA00:	01H:	ENGLISH				
	02H:	GERMAN				
	03H:	FRENCH				
	04H:	SPANISH				
	05H:	ITALIAN				
	06H:	SWEDISH				
	07H:	JAPANESE				

ACK

7FH	60H	80H	5BH	01H	DATA00	CKS
DATA00:	01H:	ENGLISH				
	02H:	GERMAN				
	03H:	FRENCH				
	04H:	SPANISH				
	05H:	ITALIAN				
	06H:	SWEDISH				
	07H:	JAPANESE				

45. COLOR SYSTEM Select

Function

The external control equipment sets the COLOR SYSTEM of the plasma monitor.

Transmission Data

DFH	80H	60H	5CH	01H	DATA00	CKS
-----	-----	-----	-----	-----	--------	-----

DATA00: 01H: 3.58NTSC
02H: 4.43NTSC
03H: PAL
04H: SECAM
0AH: AUTO1
0BH: PAL60
0CH: AUTO2
0DH: PAL- M
0EH: PAL- N

ACK

7FH	60H	80H	5CH	01H	DATA00	CKS
-----	-----	-----	-----	-----	--------	-----

DATA00: 01H: 3.58NTSC
02H: 4.43NTSC
03H: PAL
04H: SECAM
0AH: AUTO1
0BH: PAL60
0CH: AUTO2
0DH: PAL- M
0EH: PAL- N

46. Multi Screen Select

Function

The external control equipment selects single screen mode or multi screen mode of the display.

Transmission Data

DFH	80H	60H	07H	01H	DATA00	CKS
-----	-----	-----	-----	-----	--------	-----

DATA00: Multi Screen
00H: Single screen
01H: Side by Side1 (Same size screen)
02H: Side by Side2 (Left screen smaller)
03H: Picture in Picture sub screen L1
04H: Picture in Picture sub screen R1
05H: Side by Side3 (Left screen bigger)
06H: Picture in Picture sub screen L2
07H: Picture in Picture sub screen R2
08H: Picture in Picture sub screen L3
09H: Picture in Picture sub screen R3
0AH: Picture in Picture sub screen L4
0BH: Picture in Picture sub screen R4
10H: SWAP (The screen of the right and the left interchanges)

Side by Side
20H: Active Left
21H: Active Right

Picture in Picture
30H: Active Main
31H: Active Sub

ACK

The display returns the following ACK.

7FH	60H	80H	07H	01H	DATA00	CKS
-----	-----	-----	-----	-----	--------	-----

DATA00: Multi Screen
00H: Single screen
01H: Side by Side1 (Same size screen)
02H: Side by Side2 (Left screen smaller)
03H: Picture in Picture sub screen L1
04H: Picture in Picture sub screen R1
05H: Side by Side3 (Left screen bigger)
06H: Picture in Picture sub screen L2
07H: Picture in Picture sub screen R2
08H: Picture in Picture sub screen L3
09H: Picture in Picture sub screen R3
0AH: Picture in Picture sub screen L4
0BH: Picture in Picture sub screen R4
10H: SWAP (The screen of the right and the left interchanges)

Side by Side
20H: Active Left
21H: Active Right

Picture in Picture
30H: Active Main
31H: Active Sub

When other commands (except POWER OFF) are sent while the screens are switching with this command, the other command will be returned as "Not Available" until screen switching is finished.

47. FREQUENCY Request

Function

The external control equipment inquires the Horizontal frequency, Vertical frequency, Horizontal sync polarity, Vertical sync polarity, Mode, and Resolution of the plasma monitor.

Transmission Data

1FH 80H 60H 26H 00H CKS

ACK

7FH 60H 80H 26H 0BH DATA00 to DATA10 CKS

Horizontal frequency

DATA00: Integer part
 00H: 0 (No signal: 00H)
 |
 FFH: 256
 DATA01: One decimal place
 00H: 0 (No signal: 00H)
 |
 09H: 9

Vertical frequency

DATA02: Integer part
 00H: 0 (No signal: 00H)
 |
 FFH: 256
 DATA03: One decimal place
 00H: 0 (No signal: 00H)
 |
 09H: 9

Horizontal sync polarity

DATA04: 00H: –
 01H: Positive
 02H: Negative

Vertical sync polarity

DATA05: 00H: –
 01H: Positive
 02H: Negative

MODE

DATA06: 00H: No signal –
 01H to 80H: RGB signal Identification number of PC mode
 81H: Video signal 3.58NTSC
 82H: 4.43NTSC
 83H: PAL
 84H: PAL- M
 85H: PAL- N
 86H: PAL60
 87H: SECAM
 88H: B/W60
 89H: B/W50
 A0H: HD/DVD/DTV signal 480I
 A1H: 480P
 A2H: 576I
 A3H: 576P
 A4H: 720P
 A5H: 1035I
 A6H: 1080I

RESOLUTION

DATA07: Dots (Low-order byte) 00H: 0 (No signal: 00H)
 |
 FFH: 256
 DATA08: Dots (High-order byte) 00H: 257 (No signal: 00H)
 |
 FFH
 DATA09: Lines (Low-order byte) 00H: 0 (No signal: 00H)
 |
 FFH: 256
 DATA10: Lines (High-order byte) 00H: 257 (No signal: 00H)
 |
 FFH

48. Input MODE Request

Function

The display returns the current input information by the external control equipment's request.

Transmission Data

1FH 80H 60H 41H 00H CKS

ACK

7FH 60H 80H 41H 01H DATA00 CKS

DATA00: Input Select
 01H: Video1 02H: Video2
 03H: Video3 04H: HD (HD1 or DTV or DTV1)
 05H: RGB1/PC1 06H: RGB2/PC2
 0AH: DVD (DVD1) 0CH: HD2 (DTV2)
 0DH: DVD2 0EH: RGB3/PC3

49. VIDEO ADJ Request

Function

The display returns the video adjustments information by the external control equipment's request.

Transmission Data

1FH 80H 60H 45H 00H CKS

ACK

7FH 60H 80H 45H 0CH DATA00 to DATA11 CKS

DATA00: RED Gain(Bias)

D8H: -40

FFH: -1
00H: 0

IEH: +30

DATA01: GREEN Gain(Bias)

D8H: -40

FFH: -1
00H: 0

IEH: +30

DATA02: BLUE Gain(Bias)

D8H: -40

FFH: -1
00H: 0

IEH: +30

DATA03: COLOR Gain

E0H: -32

FFH: -01
00H: 0

01H: +01

20H: +32

* COLOR Gain is from -22 (EAH) to +22 (16H) only during video.

DATA04: TINT Gain

E0H: -32

FFH: -01
00H: 0

01H: +01

20H: +32

* TINT Gain is from -22 (EAH) to +22 (16H) only during video.

DATA05: SHARPNESS Gain

F0H: -16

FFH: -01
00H: 0

01H: +01

10H: +16

DATA06: CONTRAST Gain

CCH: -52

FFH: -01
00H: 0

01H: +01

14H: +20

DATA07: BRIGHT Gain

E0H: -32

FFH: -01
00H: 0

01H: +01

20H: +32

DATA08: RED Gain(Drive)

D8H: -40

FFH: -1
00H: 0

IEH: +30

DATA09: GREEN Gain(Drive)

D8H: -40

FFH: -1
00H: 0

IEH: +30

DATA10: BLUE Gain(Drive)

D8H: -40

FFH: -1
00H: 0

IEH: +30

DATA11: COLOR TEMP

00H: 1

01H: 2

02H: 3

03H: PRO

50. Audio Select Request

Function

The external control equipment inquires the current combinations of audio and video inputs for the plasma monitor.

Transmission Data

1FH 80H 60H 6FH 00H CKS

ACK

The plasma monitor returns the following ACK:

7FH 60H 80H 6FH 03H DATA00 DATA01 DATA02 CKS

DATA00: AUDIO 1
 01H – 0CH: VISUAL INPUT DATA
 DATA01: AUDIO 2
 01H – 0CH: VISUAL INPUT DATA
 DATA02: AUDIO 3
 01H – 0CH: VISUAL INPUT DATA

VISUAL INPUT DATA

01H: Video 1
 02H: Video 2
 03H: Video 3
 05H: HD (HD1 or DTV or DTV 1)
 06H: HD2 (DTV2)
 07H: RGB 1 /PC 1
 08H: RGB 2 /PC 2
 0CH: RGB 3 /PC 3

51. Failure Mode Request

Function

The external control equipment inquires the detection of failures of the plasma monitor.

Transmission Data

1FH 80H 60H 3FH 00H CKS

ACK

The plasma monitor returns the following ACK:

7FH 60H 80H 3FH 02H DATA00 DATA01 CKS

DATA00: FAILURE MODE 1
 Bit 0 : PDP MODULE
 0: Abnormal
 1: Normal
 Bit 1 : 1: fixed (backup)
 Bit 2 : TEMPERATURE
 0: Abnormal
 1: Normal
 Bit 3 : FAN
 0: Abnormal
 1: Normal
 Bit 4 : 1: fixed (backup)
 Bit 5 : 1: fixed (backup)
 Bit 6 : 1: fixed (backup)
 Bit 7 : 1: fixed (backup)
 DATA01: FAILURE MODE 2
 Bit 0–7 : 1: fixed (backup)

52. MODEL NAME Request

Function

The external control equipment inquires the product code of the plasma monitor.

Transmission Data

1FH 80H 60H 17H 00H CKS

ACK

The plasma monitor returns the following ACK:

7FH 60H 80H 17H 0CH DATA00 to DATA11 CKS

DATA00 : 1st character of the product code
 DATA01 : 2nd character of the product code
 |
 DATA11 : 12th character of the product code

NOTE:

Received data (Hex)	Corresponding character
00H	0
01H	1
08H	8
09H	9
10H	A
11H	B
12H	C
28H	Y
29H	Z
80H	- (Hyphen)
96H	(Blank)

If there are fewer than 12 characters in the product code, product code would be padded right with blanks.

Example: If the product code of your plasma monitor is "PD5020D", the returned codes would be as follows.

DATA00: 1FH
 DATA01: 13H
 DATA02: 05H
 DATA03: 00H
 DATA04: 02H
 DATA05: 00H
 DATA06: 13H
 DATA07: 96H
 DATA08: 96H
 DATA09: 96H
 DATA10: 96H
 DATA11: 96H

Table of Signals Supported

Supported resolution

- When the screen mode is NORMAL, each signal is converted to a 1024 dots × 768 lines signal. (Except for *2,3,4)
- When the screen mode is TRUE, the picture is displayed in the original resolution.
- When the screen mode is FULL, each signal is converted to a 1365 dots × 768 lines signal. (Except for *3)

Computer input signals supported by this system

Model Signal Type	Dots × lines	Vertical frequency (Hz)	Horizontal frequency (kHz)	Sync Polarity		Presence		Screen mode			RGB select*5	DVI	
				Horizontal	Vertical	Horizontal	Vertical	NORMAL (4:3)	TRUE	FULL (16:9)			
	640 × 400	70.1	31.5	NEG	NEG	YES	YES	YES*2	YES	YES	--	NO	
*IBM PC/AT compatible computers	640 × 480	59.9	31.5	NEG	NEG	YES	YES	YES	YES	YES	STILL	YES	
		72.8	37.9	NEG	NEG	YES	YES	YES	YES	YES	--	YES	
		75.0	37.5	NEG	NEG	YES	YES	YES	YES	YES	STILL	YES	
		85.0	43.3	NEG	NEG	YES	YES	YES	YES	YES	--	YES	
		100.4	51.1	NEG	NEG	YES	YES	YES	YES	YES	--	YES	
		120.4	61.3	NEG	NEG	YES	YES	YES	YES	YES	--	YES	
		848 × 480	60.0	31.0	POS	POS	YES	YES	--	YES	YES	WIDE2	YES
		852 × 480*1	60.0	31.7	NEG	NEG	YES	YES	--	YES	YES	WIDE1	YES
	800 × 600	56.3	35.2	POS	POS	YES	YES	YES	YES	YES	YES	STILL	YES
		60.3	37.9	POS	POS	YES	YES	YES	YES	YES	YES	STILL	YES
		72.2	48.1	POS	POS	YES	YES	YES	YES	YES	YES	--	YES
		75.0	46.9	POS	POS	YES	YES	YES	YES	YES	YES	--	YES
		85.1	53.7	POS	POS	YES	YES	YES	YES	YES	YES	--	YES
		99.8	63.0	POS	POS	YES	YES	YES	YES	YES	YES	--	YES
		120.0	75.7	POS	POS	YES	YES	YES	YES	YES	YES	--	YES
		1024 × 768	60.0	48.4	NEG	NEG	YES	YES	YES*3	--	YES	YES	STILL
	70.1		56.5	NEG	NEG	YES	YES	YES*3	--	YES	YES	--	YES
	75.0		60.0	POS	POS	YES	YES	YES*3	--	YES	YES	STILL	YES
	85.0		68.7	POS	POS	YES	YES	YES*3	--	YES	YES	--	YES
	100.6		80.5	NEG	NEG	YES	YES	YES*3	--	YES	YES	--	NO
		1152 × 864	75.0	67.5	POS	POS	YES	YES	YES	--	YES	STILL	YES
		1280 × 768	56.2	45.1	POS	POS	YES	YES	--	--	YES	WIDE1	NO
		1360 × 765	60.0	47.7	POS	POS	YES	YES	--	--	YES*3	WIDE1	NO
	1360 × 768	60.0	47.7	POS	POS	YES	YES	--	--	YES*3	WIDE1	YES	
	1376 × 768	59.9	48.3	NEG	POS	YES	YES	--	--	YES	WIDE2	YES	
1280 × 1024	60.0	64.0	POS	POS	YES	YES	YES*4	--	YES	YES	STILL	YES	
	75.0	80.0	POS	POS	YES	YES	YES*4	--	YES	--	--	NO	
	85.0	91.1	POS	POS	YES	YES	YES*4	--	YES	--	--	NO	
	1600 × 1200	60.0	75.0	POS	POS	YES	YES	YES	--	YES	--	--	NO
65.0		81.3	POS	POS	YES	YES	YES	--	YES	--	--	NO	
70.0		87.5	POS	POS	YES	YES	YES	--	YES	--	--	NO	
75.0		93.8	POS	POS	YES	YES	YES	--	YES	--	--	NO	
*Apple Macintosh*6	640 × 480	66.7	35.0	Sync on G	Sync on G	--	--	YES	YES	YES	--	NO	
	832 × 624	74.6	49.7	Sync on G	Sync on G	--	--	YES	YES	YES	--	NO	
	1024 × 768	74.9	60.2	Sync on G	Sync on G	--	--	YES*3	--	YES	WIDE1	NO	
	1152 × 870	75.1	68.7	Sync on G	Sync on G	--	--	YES	--	YES	WIDE1	NO	
Work Station (EWS4800)	1280 × 1024	60.0	64.6	NEG	NEG	YES	YES	YES*4	--	YES	--	YES	
		71.2	75.1	NEG	NEG	YES	YES	YES*4	--	YES	--	NO	
Work Station (HP)	1280 × 1024	72.0	78.1	--	--	--	--	YES*4	--	YES	--	NO	
Work Station (SUN)	1152 × 900	66.0	61.8	C Sync	C Sync	--	--	YES	--	YES	--	NO	
		76.0	71.7	C Sync	C Sync	--	--	YES	--	YES	--	NO	
		1280 × 1024	76.1	81.1	C Sync	C Sync	--	--	YES*4	--	YES	--	NO
Work Station (SGI)	1024 × 768	60.0	49.7	--	--	--	--	YES*3	--	YES	--	YES	
	1280 × 1024	60.0	63.9	--	--	--	--	YES*4	--	YES	--	YES	
IDC-3000G													
	PAL625P	768 × 576	50.0	31.4	NEG	NEG	YES	YES	YES*7	--	YES*7	--	NO
	NTSC525P	640 × 480	59.9	31.5	NEG	NEG	YES	YES	YES*7	--	YES*7	MOTION	NO

-
- *1 Only when using a graphic accelerator board that is capable of displaying 852×480 .
 - *2 This signal is converted to a $1024 \text{ dots} \times 640 \text{ lines}$ signal.
 - *3 The picture is displayed in the original resolution.
 - *4 The aspect ratio is 5:4. This signal is converted to a $960 \text{ dots} \times 768 \text{ lines}$ signal.
 - *5 Normally the RGB select mode suite for the input signals is set automatically. If the picture is not displayed properly, set the RGB mode prepared for the input signals listed in the table above.
 - *6 To connect the monitor to Macintosh computer, use the monitor adapter (D-Sub 15-pin) to your computer's video port. If your computer has a mini D-Sub 15-pin connector, you may have to use an RGB cable.
 - *7 Other screen modes (ZOOM and STADIUM) are available as well.

NOTE:

- *While the input signals comply with the resolution listed in the table above, you may have to adjust the position and size of the picture or the fine picture because of errors in synchronization of your computer.*
 - *When a $1280 \text{ dots} \times 1024 \text{ lines}$ signal or $1600 \text{ dots} \times 1200 \text{ lines}$ signal is input to the monitor, the picture will be compressed.*
 - *This monitor has a resolution of $1365 \text{ dots} \times 768 \text{ lines}$. It is recommended that the input signal should be XGA, wide XGA, or equivalent.*
 - *With digital input some signals are not accepted.*
 - *The sync may be disturbed when a nonstandard signal other than the aforementioned is input.*
 - *If you are connecting a composite sync signal, use the HD terminal.*
-

- * "IBM PC/AT" and "XGA" are registered trademarks of International Business Machines, Inc. of the United States.
- * "Apple Macintosh" is a registered trademark of Apple Computer, Inc. of the United States.

Troubleshooting

If the picture quality is poor or there is some other problem, check the adjustments, operations, etc., before requesting service.

Symptom	Checks	Remedy
Picture is disturbed. Sound is noisy. Remote control operates erroneously.	<ul style="list-style-type: none"> Is a connected component set directly in front or at the side of the display? 	<ul style="list-style-type: none"> Leave some space between the display and the connected components.
The remote control does not work.	<ul style="list-style-type: none"> Are the remote control's batteries worn out? 	<ul style="list-style-type: none"> Replace both batteries with new ones.
Monitor's power does not turn on when the remote control's power button is pressed.	<ul style="list-style-type: none"> Is the monitor's power cord plugged into a power outlet? 	<ul style="list-style-type: none"> Plug the monitor's power cord into a power outlet.
	<ul style="list-style-type: none"> Are all the monitor's indicators off? 	<ul style="list-style-type: none"> Press the power button on the monitor to turn on the power.
	<ul style="list-style-type: none"> Are the remote control's batteries worn out? 	<ul style="list-style-type: none"> Replace both batteries with new ones.
Monitor does not operate when the remote control's buttons are pressed.	<ul style="list-style-type: none"> Is the remote control pointed at the monitor, or is there an obstacle between the remote control and the monitor? 	<ul style="list-style-type: none"> Point the remote control at the monitor's remote control sensor when pressing buttons, or remove the obstacle.
	<ul style="list-style-type: none"> Is direct sunlight or strong artificial light shining on the monitor's remote control sensor? 	<ul style="list-style-type: none"> Eliminate the light by closing curtains, pointing the light in a different direction, etc.
	<ul style="list-style-type: none"> Are the remote control's batteries worn out? 	<ul style="list-style-type: none"> Replace both batteries with new ones.
	<ul style="list-style-type: none"> The front panel buttons of the main unit do not function. 	<ul style="list-style-type: none"> The front panel buttons do not function during Control Lock.
No sound or picture is produced.	<ul style="list-style-type: none"> Is the monitor's power cord plugged into a power outlet? 	<ul style="list-style-type: none"> Plug the monitor's power cord into a power outlet.
Picture appears but no sound is produced.	<ul style="list-style-type: none"> Is the volume set at the minimum? 	<ul style="list-style-type: none"> Increase the volume.
	<ul style="list-style-type: none"> Is the mute mode set? 	<ul style="list-style-type: none"> Press the remote control's MUTE button.
	<ul style="list-style-type: none"> Are the speakers properly connected? 	<ul style="list-style-type: none"> Connect the speakers properly.
	<ul style="list-style-type: none"> Is AUDIO INPUT set correctly? 	<ul style="list-style-type: none"> Set AUDIO INPUT on the OPTION menu correctly.
Poor picture with VIDEO signal input.	<ul style="list-style-type: none"> Improper control setting. Local interference. Cable interconnections. Input impedance is not correct level. 	<ul style="list-style-type: none"> Adjust picture control as needed. Try another location for the monitor. Be sure all connections are secure.
Poor picture with RGB signal input.	<ul style="list-style-type: none"> Improper control setting. Incorrect 15 PIN connector pin connections. 	<ul style="list-style-type: none"> Adjust picture controls as needed. Check pin assignments and connections.
Tint is poor or colors are weak.	<ul style="list-style-type: none"> Are the tint and colors properly adjusted? 	<ul style="list-style-type: none"> Adjust the tint and color (under "PICTURE").
Nothing appears on screen.	<ul style="list-style-type: none"> Is the computer's power turned on? 	<ul style="list-style-type: none"> Turn on the computer's power.
	<ul style="list-style-type: none"> Is a source connected? 	<ul style="list-style-type: none"> Connect source to the monitor.
	<ul style="list-style-type: none"> Is the power management function in the standby or off mode? 	<ul style="list-style-type: none"> Operate the computer (move the mouse, etc.).
Part of picture is cut off or picture is not centered.	<ul style="list-style-type: none"> Is the position adjustment appropriate? 	<ul style="list-style-type: none"> Adjust the "SCREEN" properly.
Image is too large or too small.	<ul style="list-style-type: none"> Is the screen size adjustment appropriate? 	<ul style="list-style-type: none"> Press the "WIDE" button on the remote control and adjust properly.
Picture is unstable.	<ul style="list-style-type: none"> Is the computer's resolution setting appropriate? 	<ul style="list-style-type: none"> Set to the proper resolution.
POWER/STANDBY indicator is lighted in orange or red.	<ul style="list-style-type: none"> Horizontal and / or vertical sync signal is not present when the Intelligent Power Manager control is on. 	<ul style="list-style-type: none"> Check the input signal.
POWER/STANDBY indicator is blinking in red.	<ul style="list-style-type: none"> The temperature inside the main unit has become too high and has activated the protector. 	<ul style="list-style-type: none"> Promptly switch off the power of the main unit and wait until the internal temperature drops. See*1.
POWER/STANDBY indicator is blinking in green and red, or green.	_____	<ul style="list-style-type: none"> Promptly switch off the power of the main unit. See *2.

*1 Overheat protector

If the monitor becomes too hot, the overheat protector will be activated and the monitor will be turned off. If this happens, turn off the power to the monitor and unplug the power cord. If the room where the monitor is installed is particularly hot, move the monitor to a cooler location and wait for the monitor to cool for 60 minutes. If the problem persists, contact your Marantz dealer for service.

*2 In the following case, power off the monitor immediately and contact your dealer or authorized Marantz Service Center.

The monitor turns off 5 seconds after powering on and then the POWER/STANDBY indicator blinks. It indicates that the power supply circuit or plasma display panel or, one or more fans have been damaged.

Specifications

Product Name	SLIM SERIES Plasma Monitor
Product Code	PD5020D
Screen Size	43.5"(H) × 24.5"(V) inches 1106(H) × 622(V) mm diagonal 50"
Aspect Ratio	16 : 9
Resolution	1365(H) × 768(V) pixels
Pixel Pitch	0.032"(H) × 0.032"(V) inches 0.81(H) × 0.81(V) mm
Color Reproduction	256 levels, 16,770,000 colors
Signals	
Synchronization Range	Horizontal : 15.5 to 93.8 kHz (automatic : step scan) Vertical : 50.0 to 120 Hz (automatic : step scan)
Input Signals	RGB, NTSC (3.58/4.43), PAL (B,G,M,N), PAL60, SECAM, HD*1, DVD*1, DTV*1
Input Terminals	
RGB	
Visual 1 (Analog)	mini D-sub 15-pin × 1
Visual 2 (Analog)	BNC (R, G, B, H/CS, V) × 1*2
Visual 3 (Digital)	DVI-I 29-pin × 1*3 (Not compatible with analog input)
Video	
Visual 1	RCA-pin × 1
Visual 2	BNC × 1
Visual 3	S ₂ -Video: DIN 4-pin × 1
DVD/HD/DTV	
Visual 1	RCA-pin (Y, PB[CB], PR[CR]) × 1*1
Visual 2	BNC (Y, PB[CB], PR[CR]) × 1*1, *2
Audio	
	Stereo RCA × 3 (Selectable)
External Control	
	D-sub 9-pin × 1 (RS-232C)
Sound output	7W+7W at 6 ohm
Power Supply	AC120V 50/60Hz
Current Rating	5.4A (maximum)
Power Consumption	480W (typical)
Dimensions	48.8 (W) × 30.2 (H) × 4.2 (D) inches 1240 (W) × 766 (H) × 107(D) mm
Weight	98 lbs / 44.5 kg
Environmental Considerations	
Operating Temperature	0°C to 35°C / 32°F to 95°F
Humidity	20 to 80% (no condensation)
Storage Temperature	-10°C to 50°C / 14°F to 122°F
Humidity	10 to 90% (no condensation)
Front Panel User Controls	Power on/off, Input source select, Volume up/down/ OSM control
Remote Control Functions	Power on/off, Input source select, OSM control, Volume up/down, Cursor (UP, DOWN, LEFT, RIGHT), Pointer, Zoom up/down, Off timer, Wireless/ Wired remote control
OSM Functions	Picture (Contrast / Brightness / Sharpness/ Color / Tint / Picture mode / Color temperature/ Noise reductions), Sound (Bass / Treble/ Balance), Screen (V-Position / H-Position/ V-Height / H-Width /Auto Picture / Fine picture/ Picture adjustment), Function (OSM/ OSM adjustment/ Power management/ Gray level/ Cinema mode/ RGB3 Adjustment, Long Life (PLE, Orbiter, Inverse, White, Screen Wiper)/ Reset)/ Options (Audio input/ BNC select/ RGBselect/ HD select/ Picture Size), Information (Frequency / Language* / Color system) *English, German, French, Italian, Spanish, Swedish, Japanese

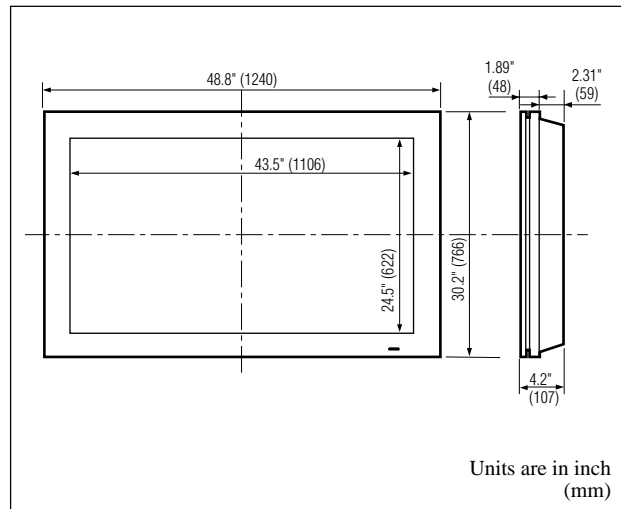

The features and specifications may be subject to change without notice.

*1 HD/DVD/DTV input signals supported on this system

480P (60 Hz)	480I (60 Hz)
525P (60 Hz)	525I (60 Hz)
576P (50 Hz)	576I (50 Hz)
625P (50 Hz)	625I (50 Hz)
720P (60 Hz)	1035I (60 Hz)
1080I (50 Hz)	1080I (60 Hz)

*2 The 5-BNC connectors are used as RGB/PC2 and HD/DVD2 input. Select one of them under "BNC SELECT".

*3 It doesn't cope with copy protection.

Other Features

3D motion adaptive Scan Converter with 2-2 (50Hz), 2-3 (60Hz) pull down Converter, Digital Zoom function (100-900% Selectable), Self Diagnosis, Anti Image Burn, Color Temperature Select, Control Lock, Power management, Plug and play (DDC1, DDC2b, RGB3: DDC2b only), MULTI SCREEN operations

Accessories

Remote control with two AAA batteries, Power cord, User's Manual, Safety metal fittings, Screws for safety metal fittings, Ferrite cores, Bands

Regulations

UL Approved (UL 60950/CSA C22.2, No. 60950)
DOC Canada requirements
Meets FCC class A requirements

COUNTRY	COMPANY	ADDRESS
ALGERIE	Azur 2000	8, Lotissement Ben Hatadi, Alger, Algerie
ARMENIA	NGYIG Ltd.	47 A/75 St. Lalaianst, 375000 Yerevan, Armenia
AUSTRALIA	Jamo Australia Pty. Ltd.,	24 Lionel Road, Mt. Waverley, VIC 3149, Australia
AUSTRIA	Huber & Prohaska GmbH	Taborstraße 95 / Ladestraße 1, Gebäude Hangartner, A-1200 Wien, Austria
BAHREIN	Ambassador Stores	P.O. Box 237,141, Government Avenue, Manama,Bahrein
BANGLADESH	Target	1078, Ramjoy Mohanja Lane Asadgonj, Chittagong 4000, Bangladesh
BELGIUM	Van der Heyden Audio N.V.	Brusselbaan 278, 9320 Erembodegem, Belgium
BULGARIA	Ariescommerce GmbH	Makedonia Blvd. 16, 1606 Sofia, Bulgaria
CANADA	Lenbrook Industries Limited	633 Granite Court, Pickering, Ontario
CHINA	Guang Chang Audio International Co., Ltd.	No.38 Yushan Road, ShiQiao, Pan Yu, Guang Dong, China
CYPRUS	Empire Hifi systems Ltd.	P.O. Box 5604, Nicosia, Cyprus
CZECH REPUBLIC	Audio International	Sokolska 41, 67902 Rajecsko, OKR,Blansko, Czech Republic
DENMARK	Audio Nord	Dali Allé 1, 9610 Noerager, Denmark
DUBAI	V.V.& SONS	P.O. Box 105, Dubai, U.A.E.
EGYPT	Solimco	9, El Attibaa St. Doki, Cairo, Egypt
ESTONIA	HiFi Club Estonia	Ehte 4, 90503 Haapsalu, Estonia
F.Y.R.O.M.	T.P. KODI	ul.Cedomir Kantargiev 21a, Skopje, Former Yugoslavian Republic of Macedonia
FINLAND	Audio Nord	Uudenmaankatu 4-6, Helsinki SF-00120, Finland
FRANCE	Marantz France	A division of Marantz Europe B.V., P.O. Box 301, 92 156 Suresnes Cedex, France
GERMANY	Marantz Deutschland	Hakenbusch 3, 49078 Osnabrück, Germany
GREECE	Adamco S.A.	188, Hippocratous Street, 11471 Athens, Greece
HEADQUARTERS EUROPE:	Marantz Europe B.V.	P.O. Box 8744, 5605 LS Eindhoven, The Netherlands
HONG KONG	Marantz Hong Kong Ltd.	Unit 1706, Metroplaza II, 223 Hing Fong Road, Kwai Fong, N.T., Kowloon, Hong Kong
HUNGARY	Infovox Ltd.	Terez Krt.31, 1067 Budapest, Hungary
ICELAND	ID Electronics Ltd.	Armula 38, 108 Reykjavik, Iceland
INDIA	NOVA Audio Private	8,Punam Co-op.Society 29/30 Road#5, Union Park MUMBAI 400052, India
IRAN	Home Co.	5th floor no 878 Philips Building Enghelab ave, P.O. 11365/7844 Tehran, Iran
IRELAND	Marantz Ireland	Clonskeagh, Dublin 14, Ireland
ISRAEL	Elmor Ltd.	52 Heh Beiyar Street, Kikar Hamedina, Tel Aviv, Israel
ITALY	Marantz Italy	Via Casati 23, 20052 Monza (Milano), Italy, Servizio Consumatori 1678-20026, Numero Verde
IVORY COAST	Hifivoir	B.P. 2428, Abidjan 01, Ivory Coast
JAPAN	Marantz Japan Inc.	35-1 Sagami Ohno 7-Chome, Sagamihara-shi, Kanagawa 228-8505, Japan
KOREA	MK Enterprises Ltd.	Rm604, Electro-officetel, 16-58. Hangang-ro 3Ga, Yongsan-Ku, Seoul, Korea
KUWAIT	alAlamiah Electronics Intl.	P.O. Box 8196, Salmiah 22052, Kuwait
LATVIA	Ace Ltd.	61, LacPlesa Str., Riga LV 1011, Latvia
LEBANON	AZ Electronics S.A., 1,	P.O. Box 11 2833, Beirut, Lebanon
LITHUANIA	Accapella Ltd.	Ausros, Vartu G/5, Pasazo SKG., 2001 Vilnius, Lithuania
MALAYSIA	Wo Kee Hong Electronics Sdn. Bhd.	Suite 8.1, Level 8, Menara Genesis, No. 33, Jalan Sultan Ismail, 50250 Kuala Lumpur, Malaysia
MALTA	Doneo Co Ltd.	78 The Strand, Sliema SLM07, Malta
MAURITIUS	SKR Electronics Ltd.	P.O. Box 685, Bell Village, Port Louis, Mauritius
MILITARY MARKET EUROPE	PASCO GmbH	PO BOX 1280, Sandhausen 69200, Germany
NETHERLANDS	Marantz Europe B.V.	P.O. Box 8744, 5605 LS Eindhoven, The Netherlands
NEW ZEALAND	Wildash Audio Systems	14 Malvern Road, Mt. Albert, Auckland, New Zealand
NORWAY	Audio Nord	Sandkerveien 64, Oslo 0483, Norway
OMAN	Mustafa & Jawad Trading CO.	P.O. Box 1918, Ruwi, Oman
POLAND	Philips Polska Sp. z.o.o.	Al.Jerozolimskie 195b, 02 222 Warszawa, Poland
PORTUGAL	Corel2	Comércio de Electrónica Lda., Av. Luis Bivar, No 85 A, 1050 Lisboa, Portugal
PROFESSIONAL EUROPE	Marantz Professional Products	Kingsbridge House, Padbury Oaks, 575-583 Bath Road, Longford, Middlesex UB7 0EH, U.K.
PROFESSIONAL U.S.A.	Marantz Professional Products	Distributed by: Superscope Technologies Inc., 1000 Corporate Blvd. Ste.D, Aurora, Illinois
QATAR	Almana & Partners W.W.L.	P.O. Box 49, Doha, Qatar
REUNION	Vision +	180 Rue du Marechal Leclerc, 97400 Saint Denis, Ile de la Reunion
ROMANIA	Nova Music Entertainment	5, Zagazului Str. Bl.1G,apt.18, sector 1,Bucharest, Romania
RUSSIA	Absolute Audio	7/2, Montazhnaya Street, 107497 Moscow, Russia
SAUDI ARABIA	Adawlia Univ. Electr. Apl	P.O. Box 2154, Alkhobar 31952, Saudi Arabia
SINGAPORE	Wo Kee Hong Distribution PTE Ltd.	130 Joo Seng Road, #03-02 Olivine Building, Singapore 368357
SLOVAKIA	Bis Audio s.r.o.	Nam. SNP 10, 96001 Zvolen, Slovakia
SLOVENIA	Bofex	Smartinska 152, HALA V/3, 61000 Ljubljana, Slovenia
SOUTH AFRICA	Coherent Imports (PTY) Ltd.	P.O. Box 1614, Alberton, 1450, South Africa
SPAIN	Marantz Spain	Martinez Villergas 2, Apartado 2065, Madrid 28027, Spain
SRI LANKA	The listening Room	Mezzanine Floor, The Landmark 385, Galle Road, Colombo - 3, Sri Lanka
SWEDEN	Audio Nord	Almedalsvagen 4, Gotenborg 402-23, Sweden
SWITZERLAND	Sound Company AG	Postfach, 8010 Zürich, Switzerland
SYRIA	Hamzeh & Partners	Hafez Ibrahim Str. No 117, Damascus Shalan, Syria
TAHITI	Covecolor	Av. Prince Hinoi, Cours de l'union sacré, P.O. Box 2334, Papeete, Tahiti
TAIWAN	Pai-Yuing Co. Ltd.	6th No 148 Sung Kiang Road, Taipei 10429, Taiwan R.O.C.
THAILAND	MRZ Standard Co. Ltd.	746-750 Mahachai Road, Wangburapa, Bangkok 10200, Thailand
TUNESIA	Societe EDEVIG	40, Avenue du Golfe Arabe, El Menzah, 1004, Tunesia
TURKEY	Türk Philips Ticaret A.S.	Yukari Dudullu Organize sanayi Bolgesi, 2.Cadde no.28, 81260 Umraniye-Istanbul, Turkey
U.K.	Marantz Hifi UK Ltd.	Kingsbridge House, Padbury Oaks, 575-583 Bath Road, Longford, Middlesex UB7 0EH, U.K.
U.S.A.	Marantz America Inc.	1100 Maplewood Drive Itasca, IL 60143, U.S.A.
YUGOSLAVIA	ITM Company	Omladinskih Brigada 86, 11070 Belgrade, Yugoslavia

www.marantz.com

marantz® is a registered trademark.

