

# INSTRUCTIONS MANUAL

## DVD+USB PLAYER



**USB**  
UNIVERSAL SERIAL BUS

**DIVX**  
VIDEO



IMPORTANT: READ THIS MANUAL BEFORE USE AND KEEP IT FOR FUTURE REFERENCES.

**LASER**



# IMPORTANT SAFEGUARDS

For your protection, please read these safety instructions completely before operating this appliance, and file for future reference.

## INSTALLATION

**Water and Moisture** - Do not use near water



**Heat** - Do not place the appliance where it can be exposed to direct sunlight or excessive heat.

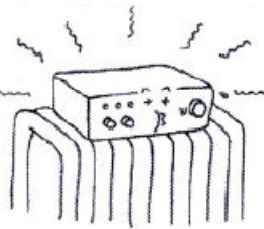

**Ventilation** - The slots and openings in the cabinet are provided for necessary ventilation.

- Never cover the slots and openings with a cloth or other materials.

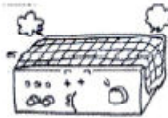

- Never place the appliance in a confined space, such as a bookcase, or built-in cabinet, unless proper ventilation is provided.

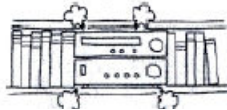

**Accessories** - Do not place the appliance on an unstable surface.

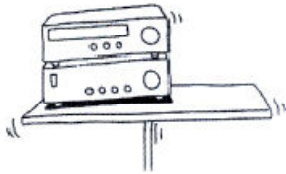

## USE

**Power Source** - This appliance should be operated only from the type of powersource indicated on the marking label.



**Overloading** - Do not overload wall outlets, extension cords or convenience receptacles beyond their capacity, since this can result in fire or electric shock.

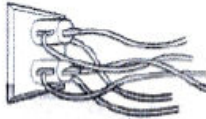

**When not in use** - Unplug the power cord of the appliance from the outlet when left unused for a long period of time. To disconnect the cord, pull it out by grasping the plug. Never pull the plug out by the cord.



# LASER

**Lightening**-For added protection for this appliance during a lightning storm, or when it is left unattended and unused for long periods of time, unplug it from the wall outlet and disconnect the antenna or cable system. This will prevent damage to the appliance due to lightning and powerline surges.

**Cleaning** - Unplug the appliance from the wall outlet before cleaning or polishing it. Do not use liquid cleaners or aerosol cleaners. Use a cloth lightly dampened with water for cleaning the exterior of the appliance.

**Object and Liquid Entry**- Never push objects of any kind into the appliance through openings as they may touch dangerous voltage points or short out parts that could result in a fire or electric shock. Never spill liquid of any kind on the appliance.

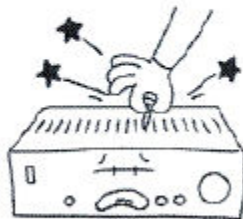
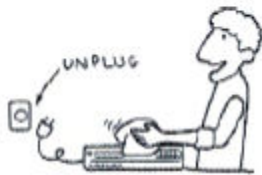

**SERVICE**

**Damage Requiring Service**-Unplug the appliance from the wall outlet and refer servicing to qualified service personnel under the following conditions:  
- When the power cord or plug is damaged or frayed.



- If liquid has been spilled or objects have fallen into the appliance.



- If the appliance has been exposed to rain or water.



- The appliance does not appear to operate normally or exhibits a marked change in performance. This indicates a need for service.



- If the appliance does not operate normally when following the operating instructions, adjust only those controls that are specified in the operating instructions. Improper adjustment of other controls may result in damage and will often require extensive work by a qualified technician to restore the appliance to normal operation.

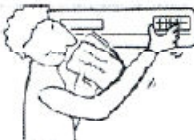

- If the appliance has been subject to excessive shock by being dropped, or the cabinet has been damaged.



**Servicing** - Do not attempt to service the appliance yourself as opening or removing covers may expose you to dangerous voltage or other hazards. Refer all servicing to qualified service personnel.



**DISCLAIMER**

Images and information in this manual are for reference only. We reserve the right to make changes to this product without notification.



# FRONT PANEL AND REAR PANEL ILLUSTRATION

## FRONT PANEL

The Front of the DVD player

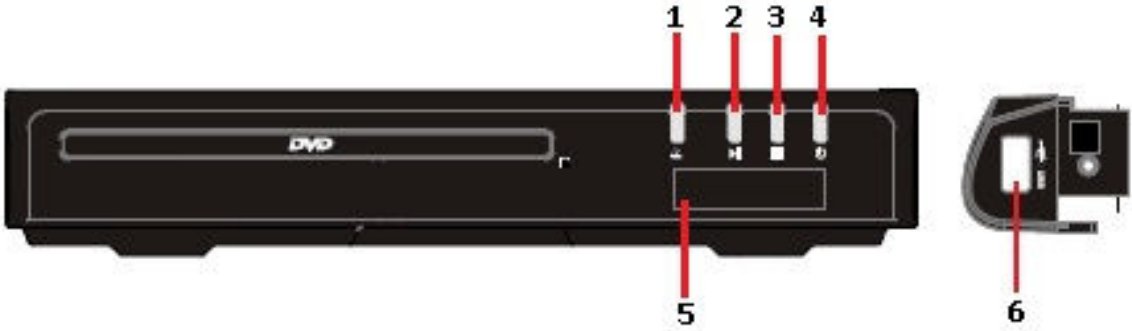

- 1 Open/Close
- 2 Play/Pause
- 3 Stop
- 4 Power
- 5 LED Display
- 6 USB Port

The Rear of the DVD player



- 1 Composite Video Out 1
- 2 Composite Video Out 2
- 3 Stereo out Left
- 4 Stereo out Right



## REMOTE CONTROL

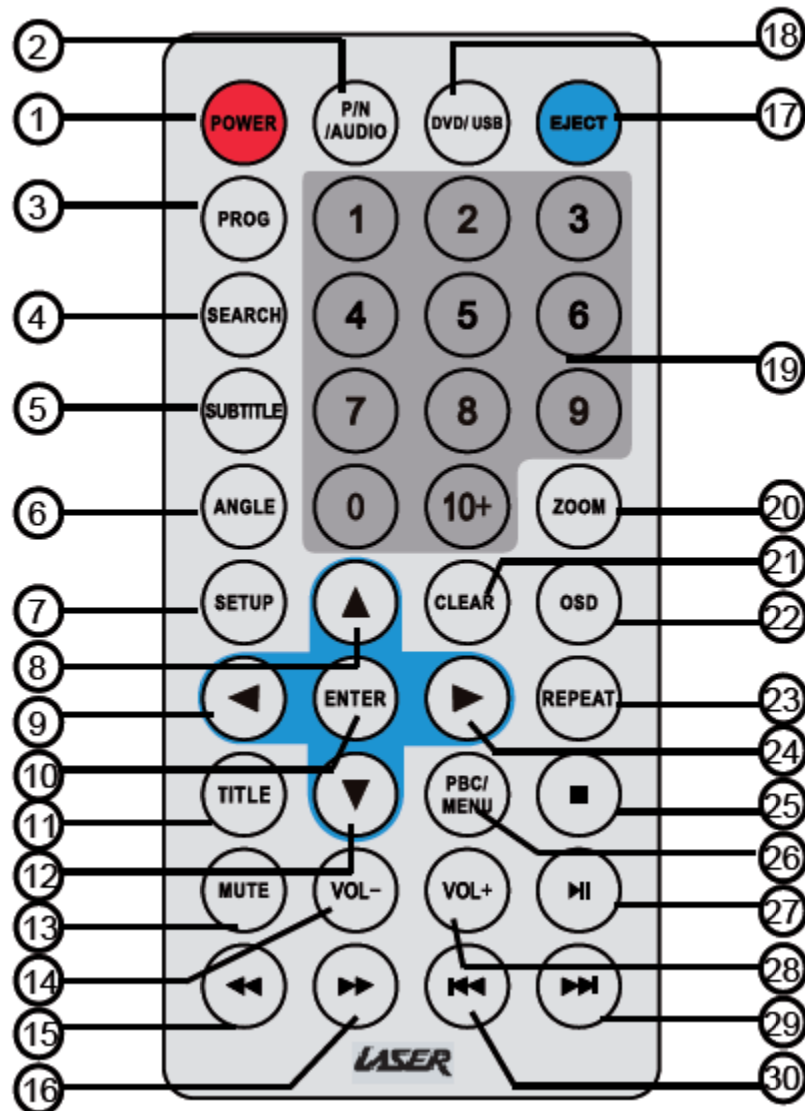

1	POWER	2	PN / AUDIO	3	PROG
4	SEARCH	5	SUBTITLE	6	ANGLE
7	SETUP	8	UP	9	LEFT
10	ENTER	11	TITLE	12	DOWN
13	MUTE	14	VOL - (DOWN)	15	FAST REV
16	FAST FWD	17	EJECT	18	DVD/USB
19	NUMERIC KEYS	20	ZOOM	21	CLEAR
22	OSD	23	REPEAT	24	RIGHT
25	STOP	26	PBC/MENU	27	PLAY/PAUSE
28	VOL + (UP)	29	NEXT	30	PREVIOUS

- *Do NOT mix new and old or different brand batteries in this remote.*
- *To ensure best performance, please replace batteries regularly.*

# LASER

# Main setup menu

This chapter allows you to customise the player according to your personal preferences.

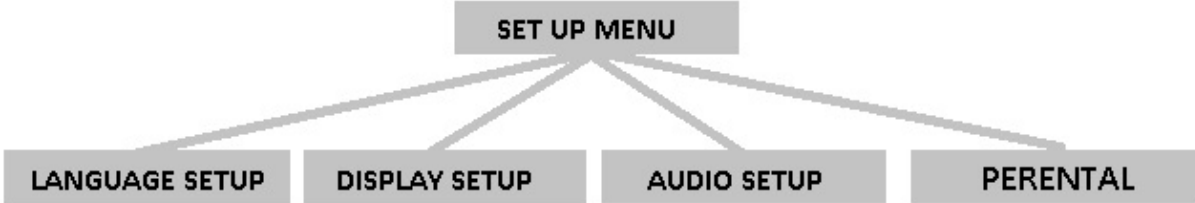

The setup menu screen, sub menus and options

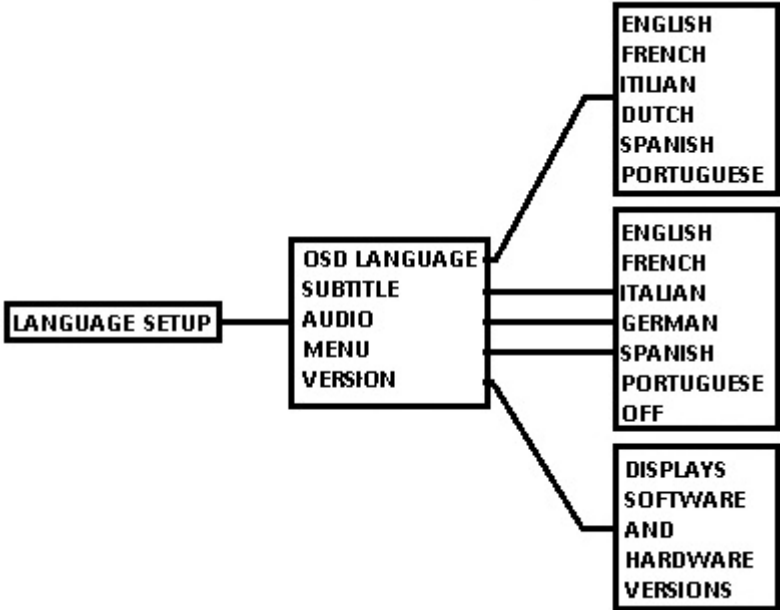

The setup menu screen, sub menus and options

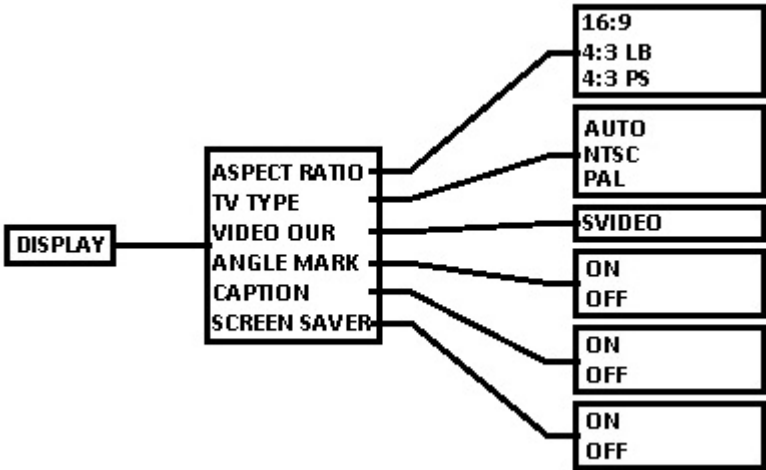

# Main setup menu

Sets the default audio output for the DVD player

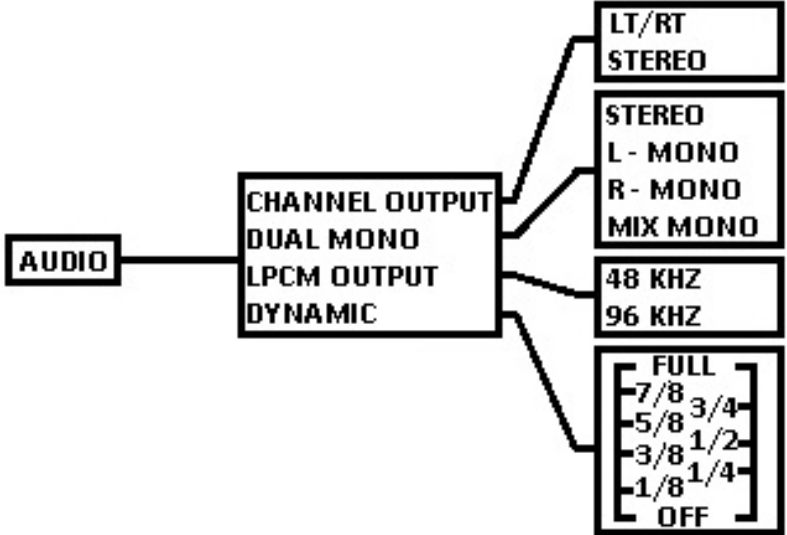

Sets the parental rating of DVDs that can be played.

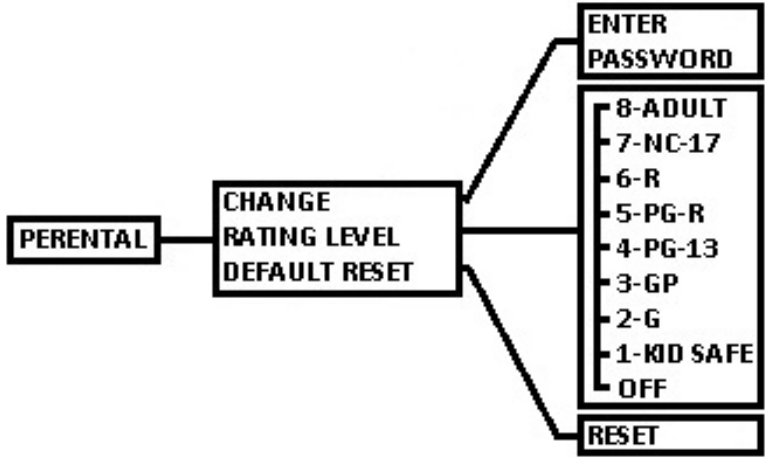

Default password is 0 0 0 0. Follow on screen prompts to change password.

Changing the rating level will require the password to be entered.

Resetting Defaults will not change the Parental ratings settings.



## REMOTE CONTROL OPERATION

#	Title	Function
1	Power	During Playback press the Power button to stop playback and enter standby mode. Press the Power button again to resume playback.
2	PN/Audio	Changes the Audio track During DVD playback
3	PROG	Program the Title and Chapter order of playback
4	Search	Search the Chapter & time to play from specific point.
5	Subtitle	Selects the Subtitle Displayed during DVD playback
6	Angle	Change the camera angle if available
7	Setup	Enter the main Setup Menu
8	UP	Navigates UP in menus
9	LEFT	Navigates LEFT in menus
10	Enter	Makes Selections
11	TITLE	Plays the main DVD menu
12	DOWN	Navigates DOWN in menus
13	MUTE	Mutes the audio during playback
14	VOL-	Decreases the Volume level
15	Fast REV	Rewinds Playback in 2, 4, 8 & 20 times normal speed
16	Fast FWD	Forwards Playback in 2, 4, 8 & 20 times normal speed
17	Eject	Ejects and loads tray
18	DVD/USB	Changes source between DISC and USB device
19	Numeric	Numeric buttons used in Search and program fields
20	Zoom	Zooms picture in or out 2,3,4, 1/2, 1/3 , & 1/4
21	Clear	Clears entries made in program and search fields
22	OSD	Displays On Screen Display
23	Repeat	Repeats Chapter, Title or ALL
24	RIGHT	Navigates RIGHT in menus
25	STOP	Stops playback
26	PCB/Menu	Turns Menu Playback ON or OFF
27	Play/Pause	Pauses/Resumes Playback
28	VOL+	Increases the Volume level
29	Next	Skips to Next Chapter/File
30	Previous	Skips to Previous Chapter/File





## Trouble Shooting

### No Video displayed on TV

- Make sure TV is turned on.
- Check the cable connections.
- Check the input selection on the TV is correct.

### Player does not respond to remote

- Clear any obstacle between the remote and the player.
- Try moving closer or reduce the angle to the player.
- Check the condition of the batteries and replace if necessary.
- Clean the sensor panel on the player.

### No audio during DVD/file playback

- Check the audio output of the player is set correctly.
- If using external amplifier/speakers, ensure connections are correct and amp is turned on.
- Check input on TV/Monitor.
- Check files audio track is supported by this player.

### Disc playback is jerky

- Check the condition of the disc. If surface is damaged or scratched repair or replace if necessary.

### Video file playback is jerky and stops

- Check the file is compatible with player.
- Check resolution of file. High Definition files may cause intermittent playback issues. Reduce resolution and bit rate of file to improve playback.

### Abnormal Player operations

- Turn the player off and unplug the player from wall. Wait for 1 or 2 minutes and plug back in. Player should now function normally.

### Disc is locked in player

- If the player will not eject disc. Turn the power OFF and then ON again. Immediately press the EJECT button (17) to open the tray.

The word "LASER" is written in a stylized, italicized, sans-serif font. The letters are bold and have a slight shadow effect, giving it a three-dimensional appearance. The 'L' and 'A' are particularly prominent.

# Technical specifications

Type of Disc	DVD/VCD/HDCD/CD/DVD±R/RW Kodak Picture CD.
Video Format	DIVX 3.0, 4.0, 5.0, MPEG 4 (AVI Container)
Audio Format	MP3 , WMA (DRM Not Supported)
<b>Signal output</b>	
Colour System	PAL/NTSC/MULIT
Audio System	AC-3 Digital output, Audio DAC 16bit/48KHZ
Video Output	2 Vpp (at 75 ohm)
Audio Output	2 Vpp
<b>Frequency Response</b>	
CD	4Hz 20KHz (EIA)
DVD	4Hz 22KHz (48K) 4Hz 44KHz (96K)
Signal to Noise Ratio (SNR)	> 92dB
THD	<0.04%
<b>Output Terminals</b>	
Video	Composite (Video) x 2
Audio : Analogue	2.0 ch (Left / Right)
Input	USB 2.0 Host port. (FAT, FAT32 Single Partition drives only)
Power input	110-240VAC 50Hz-60Hz
Power Consumption	10W
Dimensions (Player only)	260mm(w) X 235mm(D) X 45mm(H)
Weight (Player only)	1.5KG

For More information and technical support please visit  
[HTTP://WWW.LASERCO.NET](http://www.laserco.net)

