

Model EP602H



# ONE (1) YEAR LIMITED WARRANTY

**EURO-PRO Operating LLC** warrants this product to be free from defects in material and workmanship for a period of one (1) year from the date of the original purchase, when utilized for normal household use, subject to the following conditions, exclusions and exceptions.

If your appliance fails to operate properly while in use under normal household conditions within the warranty period, return the complete appliance and accessories, freight prepaid to:

**EURO-PRO Operating LLC**, 94 Main Mill Street, Door 16, Plattsburgh NY 12901

If the appliance is found by **EURO-PRO Operating LLC** to be defective in material or workmanship, **EURO-PRO Operating LLC** will repair or replace it free of charge. Proof of purchase date and \$ 9.95 to cover the cost of return shipping and handling must be included. \*

Non-durable parts including, without limitation, filters, brushes and electrical parts which normally require replacement are specifically excluded from warranty.

The liability of **EURO-PRO Operating LLC** is limited solely to the cost of the repair or replacement of the unit at our option. This warranty does not cover normal wear of parts and does not apply to any unit that has been tampered with or used for commercial purposes. This limited warranty does not cover damage caused by misuse, abuse, negligent handling or damage due to faulty packaging or mishandling in transit. This warranty does not cover damage or defects caused by or resulting from damages from shipping or repairs, service or alterations to the product or any of its parts, which have been performed by a repair person not authorized by **EURO-PRO Operating LLC**.

This warranty is extended to the original purchaser of the unit and excludes all other legal and/or conventional warranties. The responsibility of **EURO-PRO Operating LLC** if any, is limited to the specific obligations expressly assumed by it under the terms of the limited warranty. **In no event is EURO-PRO Operating LLC** liable for incidental or consequential damages of any nature whatsoever. Some states do not permit the exclusion or limitation of incidental or consequential damages, so the above may not apply to you.

This warranty gives you specific legal rights, and you may also have other rights which vary from state to state.

**\*Important: Carefully pack item to avoid damage in shipping. Be sure to include proof of purchase date and to attach tag to item before packing with your name, complete address and phone number with a note giving purchase information, model number and what you believe is the problem with item. We recommend you insure the package (as damage in shipping is not covered by your warranty). Mark the outside of your package "ATTENTION CUSTOMER SERVICE". We are constantly striving to improve our products, therefore the specifications contained herein are subject to change without notice.**



## OWNERSHIP REGISTRATION CARD

Please fill out and mail the product registration card within ten (10) days of purchase. The registration will enable us to contact you in the unlikely event of a product safety notification. By returning this card you acknowledge to have read and understood the instructions for use, and warnings set forth in the accompanying instructions.

RETURN TO: **EURO-PRO Operating LLC**, 94 Main Mill Street, Door 16, Plattsburgh NY 12901

Model EP602H

Appliance model

Date purchased

Name of store

Owner's name

Address

City

State

Zip code

Printed in China

# Shark™ Transformer Vac.™

## OWNER'S MANUAL

Model EP602H

120V., 60Hz., 10 Amps

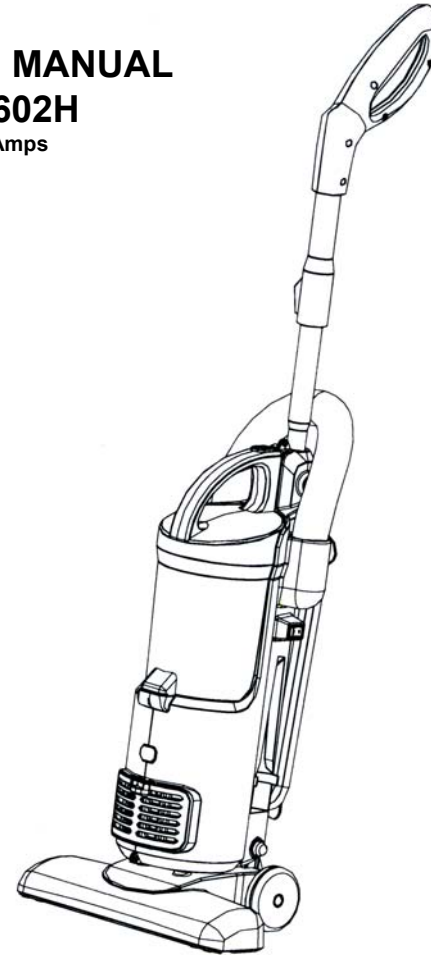

**EURO-PRO Operating LLC**

94 Main Mill Street, Door 16,  
Plattsburgh, NY 12901

Tel.: 1 (800) 798-7398



# IMPORTANT SAFETY INSTRUCTIONS

When using your **Transformer Vac** basic safety precautions should always be observed, including the following:

1. Read all instructions before using your **Transformer Vac**.
  2. Use the system only for its intended use.
  3. To protect against a risk of electric shock, do not immerse any part of the system in water or other liquids.
  4. Never yank cord to disconnect from outlet; instead, grasp plug and pull to disconnect.
  5. **Do not** allow cord to touch hot surfaces.
  6. **Do not** run appliance over cord.
  7. **Do not** operate the system with a damaged cord or plug, or if the appliance or any other part of the system has been dropped or damaged. To avoid the risk of electric shock, do not disassemble or attempt to repair the **Transformer Vac**. Return the system to **EURO-PRO Operating LLC** (see warranty) for examination and repair. Incorrect re-assembly or repair can cause a risk of electrical shock or injury to persons when the **Transformer Vac** is used.
  8. Close supervision is necessary for any appliance being used by or near children. Do not leave the system unattended while connected.
  9. Keep hair, loose clothing, fingers and all parts of body away from opening and moving parts.
  10. **Do not** use to pick up flammable or combustible liquids such as gasoline or use in areas where they may be present.
  11. **Do not** pick up anything that is burning or smoking such as cigarettes, matches or hot ashes.
  12. Use extra care when cleaning on stairs.
  13. **Do not** use the vacuum without ALL the filters in place.
  14. This appliance is intended only for household use. Follow all user instructions in this manual.
- To reduce the risk of fire, electric shock, or injury:**
- **Do not** leave the **Transformer Vac** plugged in when unattended. Unplug the electrical cord when not in use and before servicing.
  - **Do not** allow to be used as a toy. Close attention is necessary when used by or near children, pets or plants.
  - Use only as described in this manual. Use only manufacturer's recommended accessories.
  - **Do not** pull cord, use cord as a handle, close a door on cord, or pull cord around sharp edges or corners. Keep cord away from heated surfaces.
  - Use **only** extension cords UL-rated or cUL at 15 amperes. Extension cords rated for less amperage may overheat. Care should be taken to arrange the cord so that the cord cannot be pulled or tripped over.
  - Turn off all controls as applicable before unplugging from electrical outlet.
  - **Do not** handle plug or vacuum with wet hands or operate without shoes.
  - **Do not** put any objects into openings. Do not use with any opening blocked. Keep free of dust, lint, hair and anything else that may reduce air flow.
  - Store your appliance indoors in a cool, dry area.
  - Keep your work area well lit.
  - Keep end of hose, wands and other openings away from your face and body.
  - Use only on dry surfaces.
  - Using improper voltage may result in damage to the motor and possible injury to the user. Correct voltage is listed on rating label.

## SAVE THESE INSTRUCTIONS

### For Household Use Only



**WARNING:** To reduce the risk of electric shock, this appliance has a polarized plug (one blade is wider than the other). This plug will fit in a polarized outlet only one way. If the plug does not fit fully in the outlet, reverse the plug. If it still does not fit, contact a qualified electrician to install the proper outlet. Do not modify the plug in any way.

## ORDERING REPLACEMENT DUST CUP FILTERS

### TO ORDER REPLACEMENT HEPA FILTERS

Item # XSH602

for Model EP602H

Call: 1 (800) 798-7398

Monday to Friday 8:30 A.M. - 5:00 P.M. Eastern Standard Time

### FOR TECHNICAL SUPPORT

for Model EP602H

Call: 1 (800) 798-7398

Monday to Friday 8:30 A.M. - 5:00 P.M. Eastern Standard Time

#### **Please Note:**

The HEPA Filter is washable. It should, however, be replaced every three (3) to six (6) months to ensure peak performance of your vacuum.

The Pre-Motor, the Non-Woven Pre-Filter and Post Motor Filters are washable. They should however be replaced every three (3) months to ensure peak performance of your vacuum.

#### **Important:**

Make sure that **ALL** filters have been completely air dried for 24 hours before re-installing back in the vacuum.

## OPERATING INSTRUCTIONS

### Motor Thermostat

**IMPORTANT:** This unit is equipped with a motor protective thermostat. If for some reason the vacuum cleaner should overheat, the thermostat will automatically turn the unit off. Should this occur:

- Push the On/Off button once.
- Disconnect the plug from the power source.
- Check the source of overheating problem. (i.e. clogged hose or filter)

- If clogged hose or filter is found, unclog the hose and replace the filters.
- Wait at least 45 minutes before attempting to reuse the vacuum.
- After unit has cooled down for 45 minutes, plug in the cleaner and push the On/Off button. The vacuum should start again.
- If the vacuum still does not start, contact customer service at 1-800-798-7398.

## TROUBLE SHOOTING GUIDE

PROBLEM	POSSIBLE REASON	POSSIBLE SOLUTION
VACUUM WILL NOT OPERATE	<ol style="list-style-type: none"> <li>1. Power cord not firmly plugged into outlet.</li> <li>2. No power in wall outlet.</li> <li>3. Needs servicing.</li> <li>4. Thermostat has tripped.</li> </ol>	<ol style="list-style-type: none"> <li>1. Plug unit in firmly.</li> <li>2. Check fuse or breaker. Replace fuse/reset breaker.</li> <li>3. Call 1-800-798-7398.</li> <li>4. Turn the unit off and unplug from outlet. Allow unit to cool down, then restart.</li> </ol>
VACUUM WILL NOT PICK-UP OR SUCTION POWER IS WEAK	<ol style="list-style-type: none"> <li>1. Dust cup is full.</li> <li>2. Unit clogged.</li> <li>3. HEPA Filter needs cleaning or replacing.</li> <li>4. Debris screen needs cleaning.</li> <li>5. Filters need cleaning</li> </ol>	<ol style="list-style-type: none"> <li>1. Empty and clean dust cup.</li> <li>2. Turn unit off and unplug from wall outlet. Remove Dust Cup Filter and check for object(s) in air duct and remove.</li> <li>3. Clean or replace HEPA Filter.</li> <li>4. Clean debris screen.</li> <li>5. Clean Filters</li> </ol>
TURBO BRUSH DOES NOT ROTATE OR ROTATES SLOWLY	<ol style="list-style-type: none"> <li>1. Dust cup is full.</li> <li>2. Rotating brush or elbow is obstructed.</li> <li>3. Belt is broken.</li> <li>4. Hose obstructed.</li> <li>5. Debris screen is clogged.</li> <li>6. Filters need cleaning.</li> </ol>	<ol style="list-style-type: none"> <li>1. Empty dust cup.</li> <li>2. Clear obstructions.</li> <li>3. Call 1-800-798-7398.</li> <li>4. Clear obstruction.</li> <li>5. Clean debris screen.</li> <li>6. Clean all filters.</li> </ol>
DUST ESCAPING FROM VACUUM	<ol style="list-style-type: none"> <li>1. Dust cup is full.</li> <li>2. Dust Cup is not installed correctly.</li> </ol>	<ol style="list-style-type: none"> <li>1. Empty and clean dust cup.</li> <li>2. Review Dust Cup instructions.</li> </ol>
VACUUM, HOSE OR BRUSHES WILL NOT PICK-UP	<ol style="list-style-type: none"> <li>1. Hose clogged.</li> <li>2. Dust cup is full.</li> </ol>	<ol style="list-style-type: none"> <li>1. Remove hose and/or brushes. Remove obstruction from hose and /or brush.</li> <li>2. Empty and clean dust cup.</li> </ol>

## GETTING TO KNOW YOUR TRANSFORMER VAC

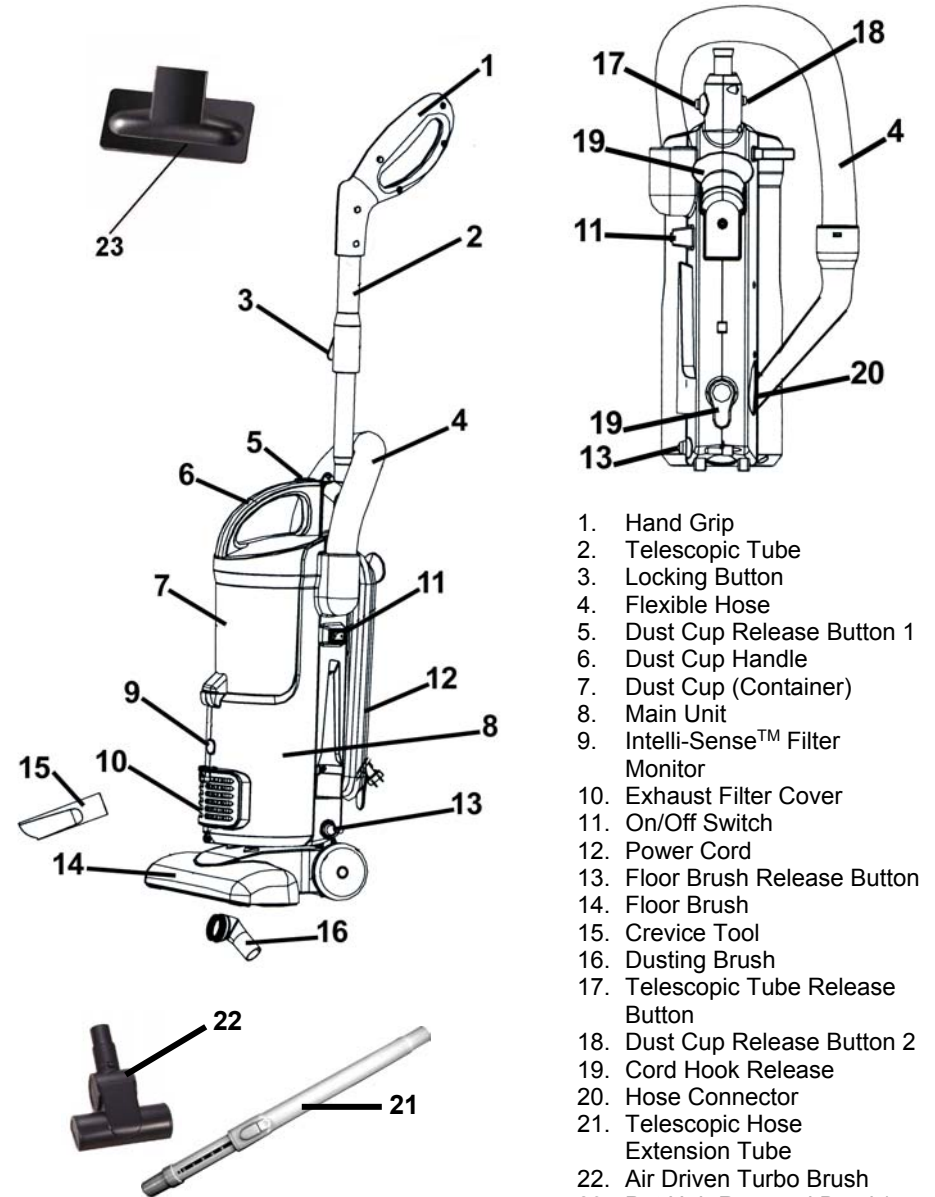

1. Hand Grip
2. Telescopic Tube
3. Locking Button
4. Flexible Hose
5. Dust Cup Release Button 1
6. Dust Cup Handle
7. Dust Cup (Container)
8. Main Unit
9. Intelli-Sense™ Filter Monitor
10. Exhaust Filter Cover
11. On/Off Switch
12. Power Cord
13. Floor Brush Release Button
14. Floor Brush
15. Crevice Tool
16. Dusting Brush
17. Telescopic Tube Release Button
18. Dust Cup Release Button 2
19. Cord Hook Release
20. Hose Connector
21. Telescopic Hose Extension Tube
22. Air Driven Turbo Brush
23. Pet Hair Removal Brush\*
24. Shoulder Strap (not shown)

### Technical Specifications

Voltage: 120V., 60Hz.  
Power: 10 Amps

\*Illustration may differ from actual product.

## PRECAUTIONARY MEASURES

**IMPORTANT:** If the suction opening in the unit or the hose is **BLOCKED**, switch off the vacuum cleaner and remove the blocking substance before you start the unit again.

1. Do not operate the vacuum cleaner too close to heaters, radiators or cigarette butts.

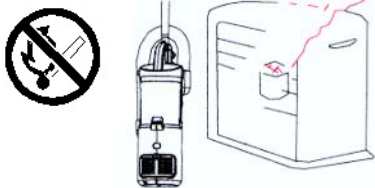

4. When pulling out the power plug from the wall outlet, pull the plug not the power cord.

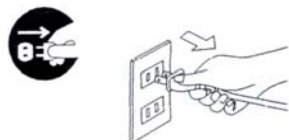

2. Before inserting the power plug into the wall outlet, make sure that your hands are dry.

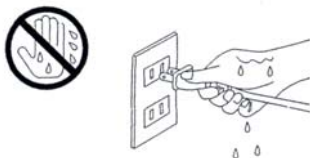

5. Do not pick up anything that is burning or smoking such as cigarettes, matches or hot ashes.

6. Do not use without ALL filters in place.

3. Before you start vacuuming, make sure to remove large or sharp objects that might damage the dust cup debris screen.

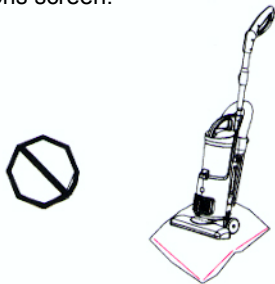

## OPERATING INSTRUCTIONS

**PLEASE NOTE:** The white pleated filter material in the HEPA Filter will discolor over time -This is **NORMAL** and will **NOT** affect the performance of the filter. If the HEPA Filter is properly

"TapCleaned" after each use and suction does not return to 100%, then we suggest that the HEPA filter be "TapCleaned" vigorously until no more dust can be removed, then rinsed under the faucet and allowed to dry for 24 hours before refitting into the vacuum. (Fig. A) **This should be done once a month or when suction appears to be reduced .**

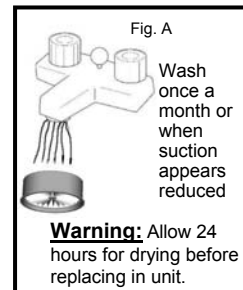

**CAUTION:** The suction hole must be open, free of any obstructions at all times. Otherwise, the motor will overheat and could become damaged.

**Warning:** Always empty the dust cup container and clean the HEPA filter, Non-Woven Pre-Filter and Debris Screen before each use and during prolonged usage.

Never over fill the dust cup container - remove dirt and clean the HEPA filter, non-woven pre-filter and debris screen when dirt in dust cup is at or below the "MAX" level during prolonged usage or risk motor damage.

**If you wash the Hepa filter or the non-woven pre-filter, make sure that they have completely air dried before inserting back in the vacuum.**

**Please Note:** The HEPA Filter is washable. It should, however, be replaced every three (3) to six (6) months to ensure peak performance of your vacuum.

The non-woven pre-filter, pre-motor and post motor filters are washable. They should however be replaced every three (3) months to ensure peak performance of your vacuum.

**Important:** make sure that **all** filters have completely air dried before re-installing back in the vacuum.

### Changing & Cleaning the Pre-Motor Filter

The pre-motor filter is a washable filter but should be replaced every three (3) months.

- Remove the dust cup container, the Non-Woven Pre- Filter and the HEPA filter to remove the pre-motor filter. (Fig 14)
- Rinse the pre-motor filter in lukewarm water and air dry the filter completely for 24 hours. Do not use a washing machine to rinse the filter. Do not use a hair dryer to dry it. Air dry only. Never operate the vacuum without the pre-motor filter in place.
- When the filter is dry, replace into the unit and replace the HEPA filter and dust cup container.
- A severely soiled or clogged filter should be thoroughly washed with fresh tepid water. A mild detergent can be used if required.

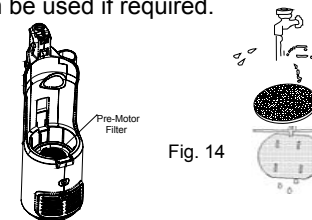

### Changing & Cleaning the Post Motor Filter

The post motor filter is a washable filter but should be replaced every three (3) months.

- Remove the filter cover from the front of the unit and remove the filter. (Fig. 15)
- Rinse the post motor filter in lukewarm water and air dry the filter completely for 24 hours. Do not use a washing machine to rinse the filter. Do not use a hair dryer to dry it. Air dry only. Never operate the vacuum without the post motor filter in place.
- When the filter is dry, replace into the filter cover and replace the filter cover to the unit.
- A severely soiled or clogged filter should be thoroughly washed with fresh tepid water. A mild detergent can be used if required.

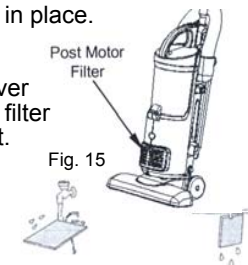

## OPERATING INSTRUCTIONS

### Emptying the Dust Cup Container and Cleaning / Changing the Non-Woven Pre-Filter, HEPA Filter & Debris Screen

**Warning:** Always unplug the unit from electrical outlet before opening the Dust Cup (container).

**Important:** Do NOT use the vacuum without the HEPA filter in place.

**Warning:** After each Use - Always remove filter assembly and the dust cup cover with the debris screen, then vigorously "TapClean" HEPA filter and clean debris screen and non-woven pre-filter until no more dust can be removed.

**IMPORTANT, Please Note :** The "TapClean" HEPA Filter will stop most of the tiniest dust particles from re-entering the air you breathe. In fact it stops 99.97% of all particles as small as 0.3 microns - many times smaller than a human hair!!! Because of this incredible filtration performance, the HEPA Filter will quickly accumulate, inside the white filter folds, many fine dust particles that are difficult to see but which will eventually block or reduce your suction power - if not cleaned properly.

1. To remove the dust cup container, first press on the dust cup release button (1) that is located on the dust cup handle and at the same time press on the dust cup release button (2) that is on the side of the upper housing (Fig. 8). Then pull the dust cup container out.

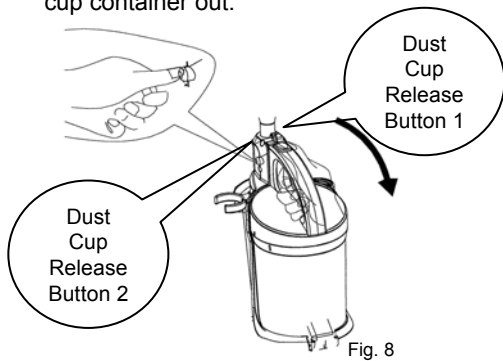

Fig. 8

2. To empty the dust cup container, press on the trap door release button that is on the back side of the dust cup container. (Fig. 9)



Fig. 9

3. The HEPA filter is located underneath the dust cup container. (Fig. 10) Remove the non-woven pre-filter. (Fig. 11) Remove the HEPA filter, hold the edges and pull it out slowly.

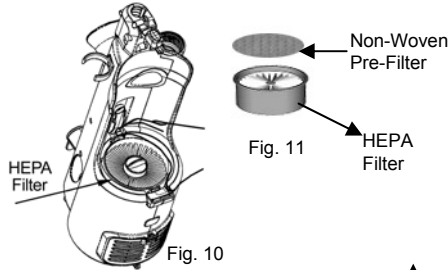

Fig. 11

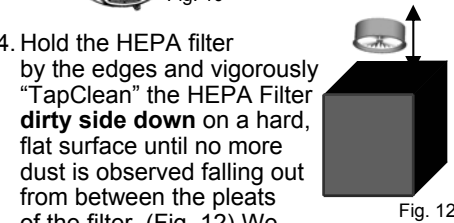

Fig. 12

4. Hold the HEPA filter by the edges and vigorously "TapClean" the HEPA Filter **dirty side down** on a hard, flat surface until no more dust is observed falling out from between the pleats of the filter. (Fig. 12) We recommend washing the HEPA filter once a month or when suction appears to be reduced. Let the HEPA filter air dry completely for 24 hours.
5. Rinse the non-woven pre-filter and let air dry completely.
6. Insert the non-woven pre-filter.
7. Reinstall the HEPA filter in the vacuum.
8. To separate the debris screen from the dust cup, hold the dust cup in one hand and turn the dust cup cover counter clockwise and pull apart. To clean the debris screen, we recommend that you rinse it under lukewarm running water to remove the dirt that accumulates on it, but always allow it to completely air dry before inserting back into the vacuum. (Fig. 13)

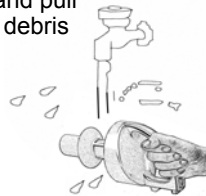

Fig. 13

## OPERATING INSTRUCTIONS

**WARNING:** Always remove the power plug from the wall outlet before assembling or removing accessories.

### EXTENDING THE TELESCOPIC TUBE

Push the plastic button and pull out the smaller tube. See illustration below.

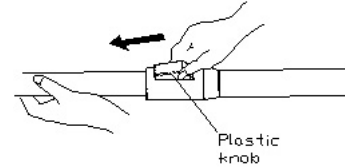

### INSERTING THE TELESCOPIC TUBE INTO THE MAIN UNIT

- Insert the telescopic tube into the hole next to the dust cup handle. Make sure that the slot in the handle fits correctly into the opening. (Fig. 1)
- To remove the telescopic tube, press the telescopic tube release button and pull the tube up.

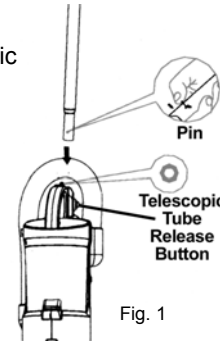

Fig. 1

### ATTACHING THE FLOOR BRUSH TO THE MAIN UNIT

- Insert the floor brush into its location, in the direction of the arrow. (Fig. 2)
- To remove the floor brush from the main unit, press on the floor brush release button and pull the floor brush out.

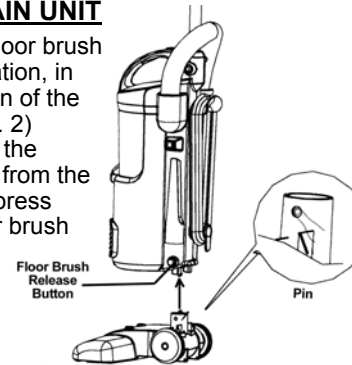

Fig. 2

### ATTACHING THE HOSE TO THE MAIN UNIT

- Hold the end of the hose.
- Insert the hose into the hose connector (Fig. 3).

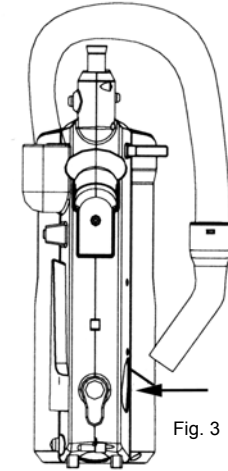

Fig. 3

### WINDING & UNWINDING THE POWER CORD

This vacuum cleaner is equipped with a convenient cord storage feature. The power cord winds around the two cord holders at the back of the unit. The bottom one has a quick cord release feature. Turn the cord hook to the left or the right to remove the power cord. (Fig. 4)

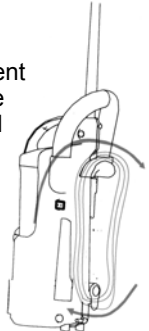
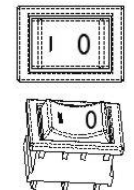
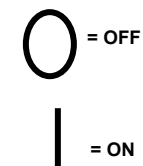

Fig. 4

### ON/OFF SWITCH

- The On/Off switch has two different positions.
- Push on the "I" side to turn the vacuum ON.
- Push on the "O" side to turn the vacuum OFF.



## OPERATING INSTRUCTIONS

### USING THE UNIT AS AN UPRIGHT

- Unwind the power cord and plug into the 120V outlet.
- Push down on the locking button to adjust the height of the telescopic handle.

**NOTE:** When vacuuming deep pile carpets or hard to vacuum carpets, lower the angle of the telescopic handle (see illustration at right) for easier maneuverability.

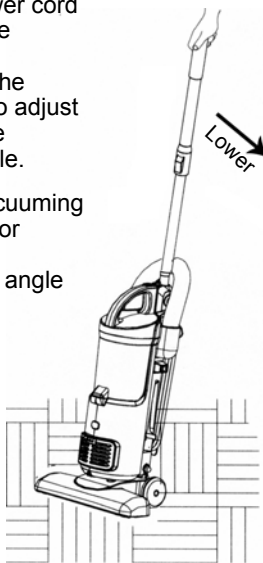

### USING THE UNIT AS A HAND VACUUM

- Press the telescopic tube release button to remove the telescopic tube. (See Fig. 1 page 4)
- Press the floor brush release button to remove the floor brush. (See Fig 2 page 4)
- Attach the shoulder strap to the shoulder strap attachment point. (See illustration below.)
- Attach the crevice tool or the dusting brush to the end of the hose.

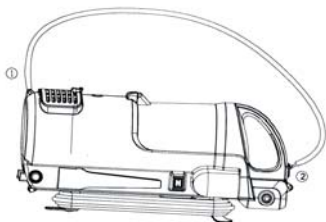

Fig. 5

### ⚠ WARNING

After extended use, the body of the vacuum cleaner may become hot. When using the unit with the shoulder strap, the unit will touch the body of the user. Therefore, make sure that the unit body is cool before you use with the shoulder strap. If during use, the vacuum gets too warm, allow it to cool before continuing to use.

#### **Crevice Tool**

For radiators, crevices, corners, baseboards and between cushions.

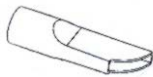

#### **Dusting Brush**

The dusting brush is used for the furniture, venetian blinds, books, lamp shades and shelves.



#### **Pet Hair Removal Brush**

The pet hair removal brush is for use on upholstery, drapes and other fabric surfaces to remove lint, pet hair, etc. **THE PET HAIR REMOVAL BRUSH IS NOT INTENDED TO BE USED AS A PET GROOMING DEVICE.**



#### **Flexible Hose Telescopic Extension Tube**

To use with all accessories to reach hard to reach places.



## OPERATING INSTRUCTIONS

### Intelli-Sense™ Filter Monitor

When the Intelli-Sense™ Filter Monitor lights up, it means that the dust cup is full or the HEPA filter, non-woven pre-filter or debris screen needs cleaning. You must empty the dust from the dust cup and clean the HEPA filter, non-woven pre-filter and debris screen right away.

### Air Driven Turbo Brush

#### **Using The Unit With Air Driven Turbo Brush**

The efficiency of your air driven turbo brush depends on the bristle brush rotating at high speed. Strong air suction is needed to accomplish this. In order to ensure that maximum air suction is maintained, please read the following instructions:

1. Empty the dust cup frequently.
2. Always shake out the HEPA filter and clean the non-woven pre-filter and debris screen when emptying the dust cup container.
3. Ensure that the rotating brush is kept free of hair and string which may accumulate and decrease brush performance.
4. Keep Air Driven Turbo Brush turbine free of dirt and foreign matter. (See cleaning instructions.)

#### **Attaching the Air Driven Turbo Brush to the Flexible Hose**

To use the air driven turbo brush to clean upholstery:

1. Remove the flexible hose from the hose connector. (Fig. 6)
2. Push the air driven turbo brush onto the end of the flexible hose as far as it will go.

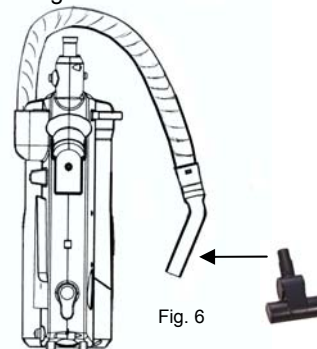

Fig. 6

**Important:** In order to ensure that maximum air suction is maintained, empty the dust cup frequently and shake out the HEPA filter, non-woven pre-filter and debris screen at the same time. Ensure that the rotating brush is kept free of hair and string which may accumulate and decrease brush performance.

#### **Attaching the Air Driven Turbo Brush to the Flexible Hose Telescopic Extension Tube**

To use the air driven turbo brush or other accessory with the flexible hose telescopic extension tube:

1. Remove the flexible hose from the hose connector.
2. Insert the top end of the telescopic extension tube to the end of the flexible hose.
3. Push the air driven turbo brush or other accessory onto the end of the telescopic extension tube as far as it will go.

#### **Cleaning Air Driven Turbo Brush**

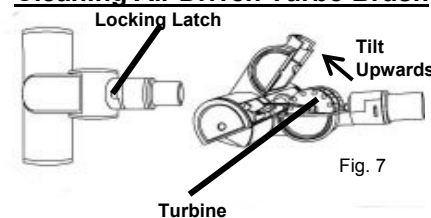

Fig. 7

From time to time, the turbine of your turbo brush will require cleaning. To do this:

1. Remove the turbo brush from the hose or telescopic extension tube.
2. Slide locking latch forward then tilt the top housing of the brush upwards. The top housing is hinged and will tilt up approximately 45° only. (Fig. 7)
3. There may be some dust, lint, hair, etc on the turbine wheel. Remove as much of this as possible.
4. You may also use the unit's hose with crevice tool attached and use the vacuum to remove any additional debris from the turbine.
5. Ensure that the turbine wheel moves freely by rotating it with your finger. If the turbine does not rotate, call Customer Service for help.
6. Once clean, close the top cover of the turbo brush and slide the locking latch toward the rear of the brush to lock.