

**Read and save these instructions.**

# **OWNER'S GUIDE**

## **Microwave Oven**



**Models:**  
**FMT116U1B**  
**FMT116U1A**  
**FMT116U1W**

**P/N 317002752(9501) / 3874W500992**

.

.

# Table of Contents

<b>A Note To You</b> .....	3
<b>Understanding Microwave Oven Safety</b> .....	4
<b>Precautions To Avoid Possible Exposure To Excessive Microwave Energy</b> .....	6
<b>Getting To Know Your Microwave Hood Combination</b> .....	9
How microwave cooking works.....	9
Microwave oven features .....	11
Control panel features .....	12
Using the exhaust fan .....	14
Using the cooktop/countertop light .....	14
Using the bi-level cooking rack .....	15
Setting the clock .....	15
Using the Timer .....	16
<b>Using Your Microwave Oven</b> .....	17
Getting the best cooking result .....	17
Cooking at high cook power .....	18
Cooking at lower power levels .....	19
Cooking with more than one cook cycle .....	21
Using AUTO WEIGHT DEFROST .....	22
Auto weight defrost chart .....	23
Defrosting tips .....	25
Using KEEP WARM.....	26
<b>One Touch Cook Pads</b> .....	27
Using PERSONAL CHOICE .....	27
Using BAKED POTATO.....	28
Using POPCORN .....	29
Using BEVERAGE.....	30
Using FROZEN VEGETABLE .....	30
Using DINNER PLATE .....	31
Using PLUS ONE MINUTE.....	32
<b>Caring For Your Microwave Hood combination</b> .....	33
<b>Cooking Guide</b> .....	37
<b>Questions And Answers</b> .....	41
<b>If You Need Assistance Or Service</b> .....	42

.

.

# A Note To You

## Thank you for buying a Frigidaire appliance.

You have purchased a quality, world-class home appliance. Years of engineering experience have gone into its manufacturing. To ensure that you will enjoy many years of trouble-free operation, we have developed this Owner's Guide. It is full of valuable information on how to operate and maintain your appliance properly and safely. Please read it carefully. Also, please complete and mail the Ownership Registration Card provided with your appliance. This will help us notify you about any new information on your appliance.

## Your safety is important to us.

This guide contains safety symbols and statements. Please pay special attention to these symbols and follow any instructions given. Here is a brief explanation of the use of each symbol.

### **WARNING**

This symbol will help alert you to such dangers as personal injury, burns, fire and electrical shock.

### **CAUTION**

This symbol will help you avoid actions which could cause product damage (scratches, dents, etc.) and damage to your personal property.

## Our Service Center number, 1-800-451-7007, is toll-free, 24 hours a day.

If you ever have a question concerning your appliance's operation, or if you need service, first see "If You Need Assistance Or Service" on page 42. If you need further help, feel free to call our Service Center. When calling, you will need to know your appliance's complete model number and serial number. You can find this information on the model and serial number plate (see diagram on page 11). For your convenience, we have included a handy place below for you to record these numbers, the purchase date from the sales slip and your dealer's name & telephone number. Keep this book and the sales slip together in a safe place for future reference.

Model Number \_\_\_\_\_

Serial Number \_\_\_\_\_

Purchase Date \_\_\_\_\_

Dealer Name \_\_\_\_\_

Dealer Phone \_\_\_\_\_

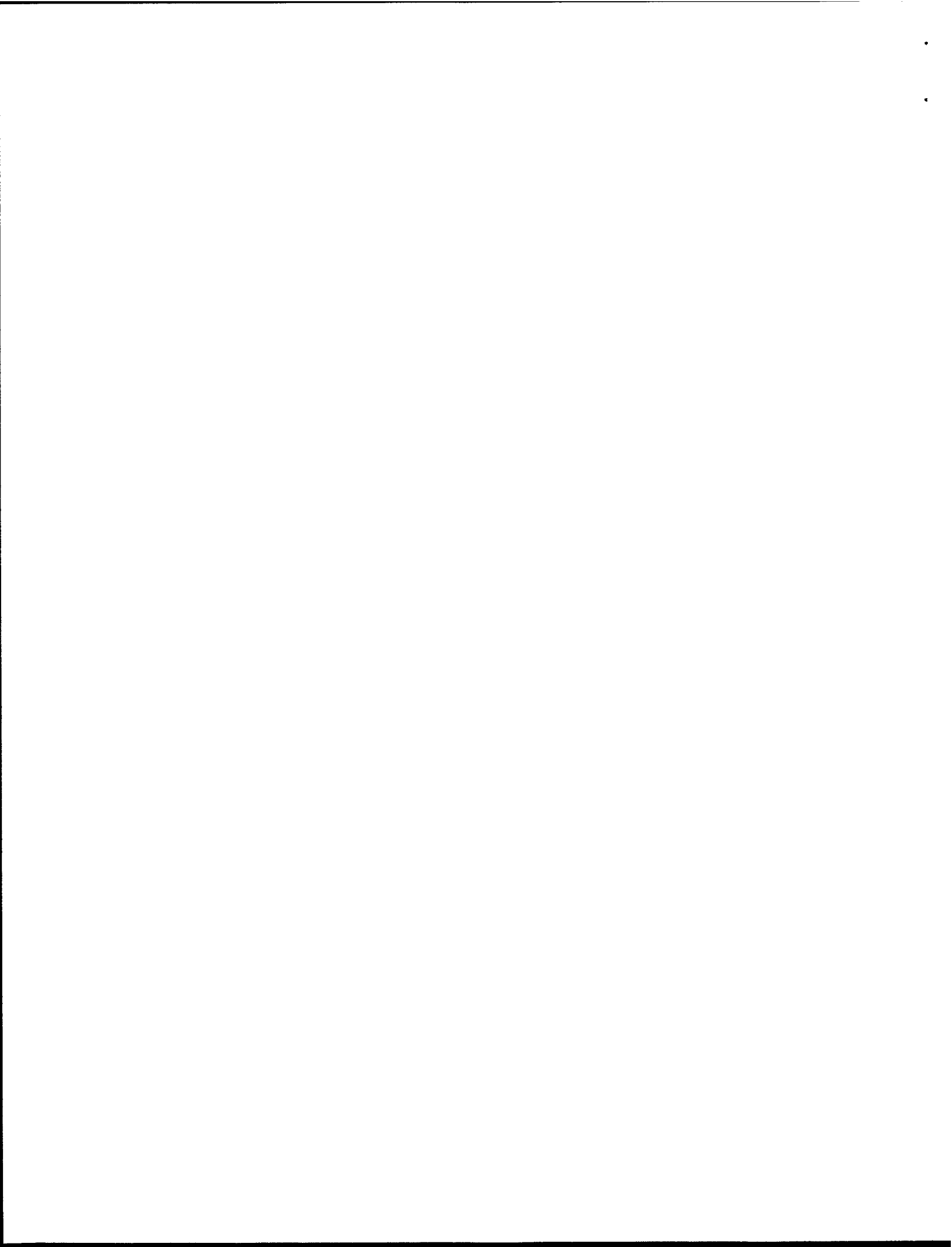

# Understanding Microwave Oven Safety

## IMPORTANT SAFETY INSTRUCTIONS

Microwave ovens have been thoroughly tested for safe and efficient operation. However, as with any appliance, there are special installation and safety precautions which must be followed to ensure safe and satisfactory operation and prevent damage to the unit.

### **WARNING**

**To reduce the risk of burns, fire, electrical shock, injury to persons, exposure to excessive microwave energy, or damage when using the microwave oven, follow basic precautions, including the following:**

- Read all instructions before using the microwave oven.
- Read and follow the specific "PRECAUTIONS TO AVOID POSSIBLE EXPOSURE TO EXCESSIVE MICROWAVE ENERGY" found on page 6.
- This appliance must be grounded. Connect only to properly grounded outlet. See "GROUNDING INSTRUCTIONS" found in the Installation Instructions.
- Install or locate this appliance only in accordance with the provided Installation Instructions.
- Some products such as whole eggs in the shell and sealed containers—for example, closed glass jars—may explode and should not be heated in this oven.
- Do not heat, store or use flammable materials in or near the oven. Fumes can create a fire hazard or explosion.
- Use this appliance only for its intended use as described in this manual. Do not use corrosive chemicals or vapors in this appliance. This type of oven is specifically designed to heat or cook food. It is not designed for industrial or laboratory use.
- As with any appliance, close supervision is necessary when used by children.
- Do not operate this appliance if it is not working properly, or if it has been damaged. Electrical shock, fire or other hazards may result.
- This appliance should be serviced only by qualified service personnel. Call an authorized Frigidaire service company for examination, repair or adjustment. Refer to service information on the last page of this owner's guide for complete details.
- Do not cover or block any opening on the appliance. Fire may result.
- Do not store this appliance outdoors. Do not use this product near water — for example, near a kitchen sink, in a wet basement, or near a swimming pool, and the like.
- Do not immerse cord or plug in water.
- Keep cord away from heated surfaces.
- Do not let cord hang over edge of table or counter.
- This appliance is suitable for use above both gas and electric cooking equipment 36 inches or less wide.
- See door surface and interior cleaning instructions on page 33.
- To reduce the risk of fire in the oven cavity:
  - Do not overcook food. Carefully attend appliance if paper, plastic, or other combustible materials are placed inside the oven to facilitate cooking. Paper can char or burn, and some plastics can melt if used when heating foods.
  - Do not deep fry in oven. Microwavable utensils are not suitable and it is difficult to maintain appropriate deep frying temperatures.

continued on next page

.

.



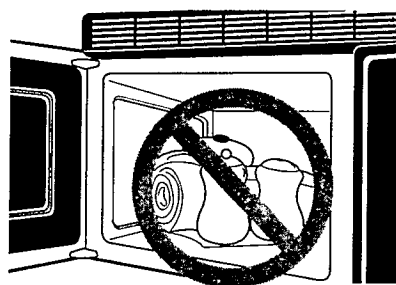
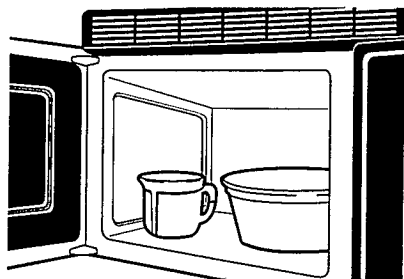

To reduce the risk of fire in the oven cavity (continued):

— **Test dinnerware or cookware before using.**

To test a dish for safe use, put it into the oven with a cup of water beside it. Cook at 100% Cook Power for one minute. **If the dish gets hot and water stays cool, do not use it.** Some dishes (melamine, some ceramic dinnerware, etc.) absorb microwave energy, becoming too hot to handle and slowing cooking times. Cooking in metal containers not designed for microwave use can damage the oven, as can containers with hidden metal (twist-ties, foil lining, staples, metallic glaze or trim)

— Remove wire twist-ties from paper or plastic bags before placing bag in oven.

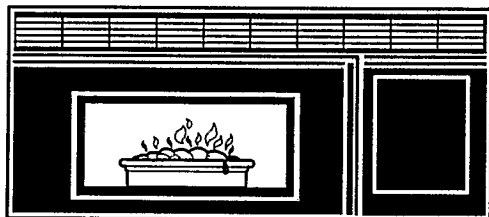

— If materials inside the oven should ignite, keep oven door closed, turn oven off, and disconnect the power cord or shut off power at the fuse or circuit breaker panel.

— Do not use the cavity for storage purposes.

Do not leave paper products, cooking utensils, or food in the cavity when not in use.

● Because of the automatic exhaust fan feature, the following cautions must be observed:

— Do not leave the area when using your cooktop at a high setting. Accidental fires from boilovers or spattering on the surface unit could spread, especially if the exhaust fan is operating.

— Do not allow grease and soil to build up in the grease filter. Exhaust fan efficiency will decrease and fire may result. Clean often following the filter cleaning instructions on page 34.

— Do not change the cooktop or oven lights without turning the power off at the main power supply (see page 35). Electrical shock may result.

— Do not flame foods on a cooktop surface below this unit. The fan, if operating, may spread the flame and cause personal injury or property damage.

● Use care when cleaning the vent hood filter. Corrosive cleaning agents, such as lye-based oven cleaners, may damage filter.

● Read and follow "Operating safety precautions" starting on page 7.

## SAVE THESE INSTRUCTIONS



## PRECAUTIONS TO AVOID POSSIBLE EXPOSURE TO EXCESSIVE MICROWAVE ENERGY...

**Do not** attempt to operate this oven with the door open since open-door operation can result in harmful exposure to microwave energy. It is important not to defeat or tamper with the safety interlocks.

**Do not** place any object between the oven front face and the door or allow soil or cleaner residue to accumulate on sealing surfaces.

**Do not** operate the oven if it is damaged. It is particularly important that the oven door close properly and that there is no damage to the:

- (1) Door (bent),
- (2) Hinges and latches (broken or loosened),
- (3) Door seals and sealing surfaces.

**Do not** operate the microwave oven if the door window is broken.

The microwave oven should be checked for microwave leakage by qualified service personnel after a repair is made.

The oven should not be adjusted or repaired by anyone except properly qualified service personnel.

**Do not** operate the microwave oven with the outer cabinet removed.



## Operating safety precautions

### **⚠ WARNING**

To reduce the risk of burns, fire, electrical shock, injury to persons, or damage when using the microwave oven, follow the precautions on page 7-8.

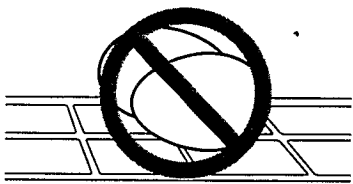

**Never cook or reheat a whole egg inside the shell.** Steam buildup in whole eggs may cause them to burst and burn you, and possibly damage the oven. **Slice** hard-boiled eggs before heating. In rare instances, poached eggs have been known to explode. **Cover** poached eggs and **allow** a standing time of one minute before cutting into them.



**Stir before heating**

**For best results, stir any liquid several times before heating or reheating.** Liquids heated in certain containers (especially cylindrical containers) may become over-heated. The liquid may splash out with a loud noise during or after heating or when adding ingredients (coffee, tea bag, etc.) resulting in harm to the oven and possible personal injury.

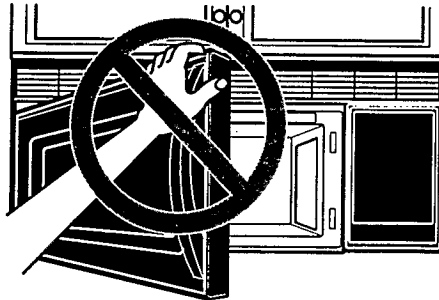

**Never lean on the door or allow a child to swing on it** when the door is open. Injury could result.

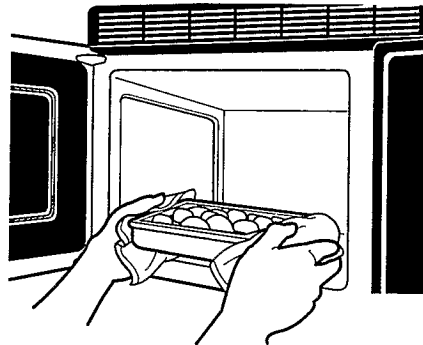

**Use hot pads.** Microwave energy does not heat containers, but the hot food does.

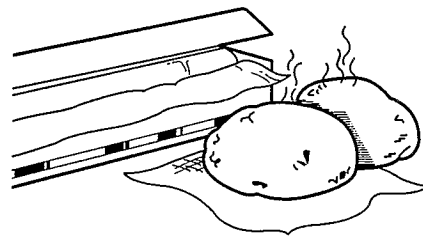

**Do not overcook potatoes.** Fire could result. At the end of the recommended cooking time, potatoes should be slightly firm because they will continue cooking during standing time. **After microwaving, wrap** potatoes in foil and **set aside** for 5 minutes. They will finish cooking while standing.



# UNDERSTANDING MICROWAVE OVEN SAFETY

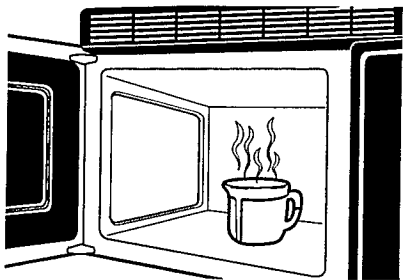

**Do not** start a microwave oven when it is empty. Product life may be shortened.

If you practice programming the oven, **put** a container of water in the oven.

It is normal for the inside of the oven door to look wavy after the oven has been running for a while.

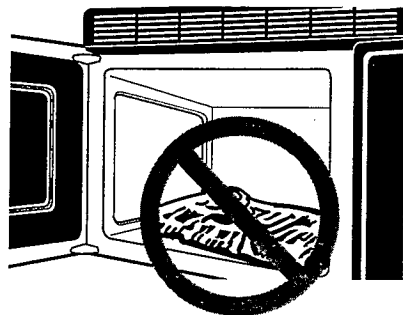

**Do not** use newspaper or other printed paper in the oven. Fire could result.

**Do not** dry flowers, fruit, herbs, wood, paper, gourds or clothes in the oven. Fire could result.

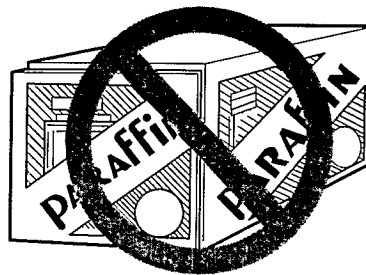

**Do not** try to melt paraffin wax in the oven. Paraffin wax will not melt in a microwave oven because it allows microwaves to pass through it.

## General information

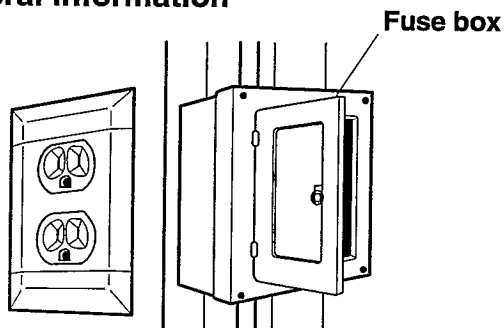

**If your electrical power line or outlet voltage is less than 110 volts**, cooking times may be longer. Have a qualified electrician check your electrical system.

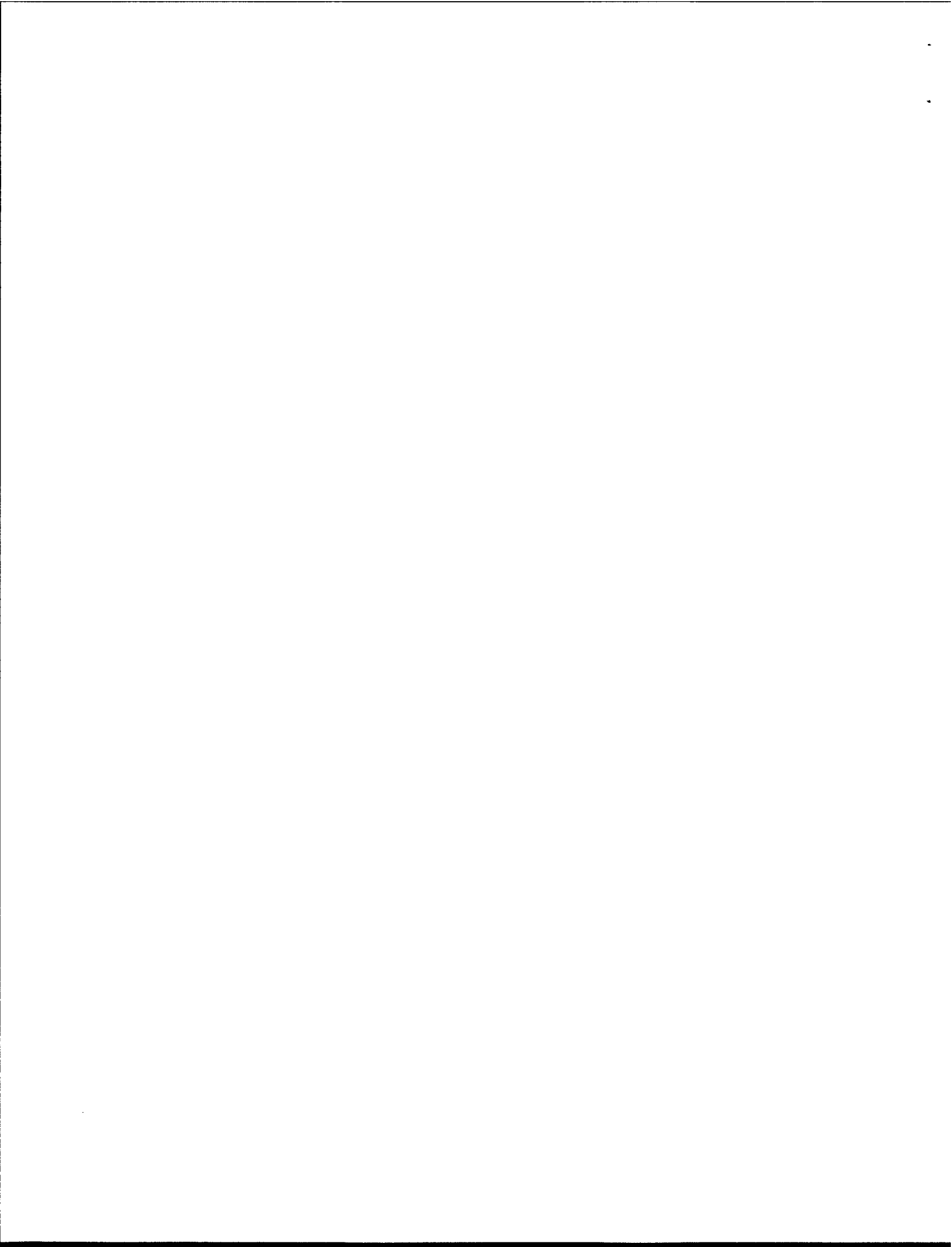



# Getting To Know Your Microwave Hood Combination

This section discusses the concepts behind microwave cooking and introduces you to the basics you need to know to operate your microwave oven. Please read this information before use.

In This Section		page	page
How microwave cooking works.....	9	Using the cooktop/countertop light .....	14
Microwave oven features .....	11	Using the bi-level cooking rack .....	15
Control panel features .....	12	Setting the clock .....	15
Using the exhaust fan.....	14	Using the Timer.....	16

## How microwave cooking works

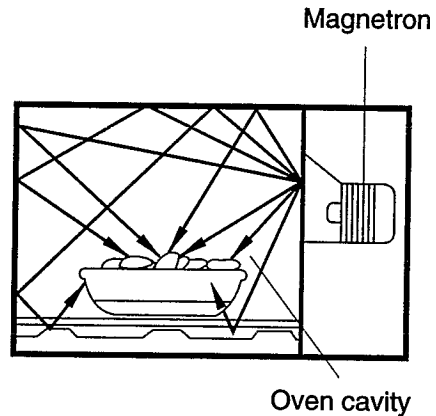
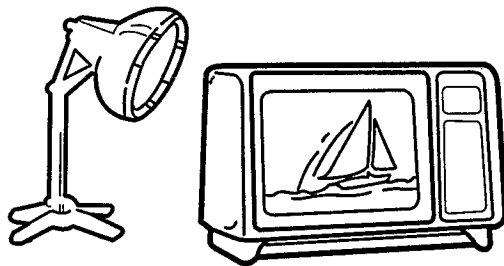

**Microwave ovens are safe.** Microwave energy is not hot. It causes food to make its own heat, and it's this heat that cooks the food.

Microwaves are like TV waves or light waves. You cannot see them, but you can see what they do.

**A magnetron** in the microwave oven produces microwaves. The microwaves move into the oven where they contact the food.



## GETTING TO KNOW YOUR MICROWAVE HOOD COMBINATION

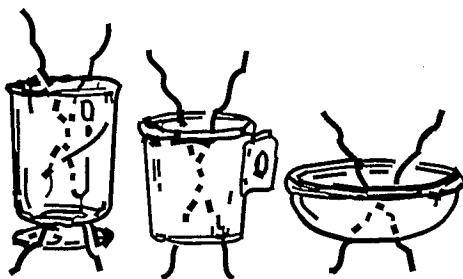

**Microwaves** pass through most glass, paper and plastics without heating them so food absorbs the energy. Microwaves bounce off metal pans so food does not absorb the energy.

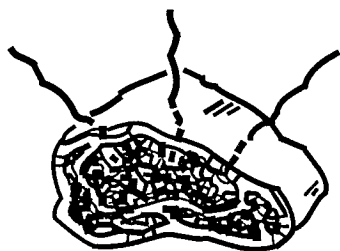

**Microwaves** may not reach the center of a roast. The heat spreads to the center from the outer, cooked areas just as in conventional cooking. This is one of the reasons for letting some foods (for example, roasts or baked potatoes) stand for a while after cooking, or for stirring some foods during the cooking time.

The microwaves disturb water molecules in the food. As the molecules bounce around bumping into each other, heat is made, like rubbing your hands together. This is the heat that does the cooking.

### Radio interference

Operation of the microwave oven may cause interference to your radio, TV or similar equipment. When there is interference, it may be reduced or eliminated by taking the following measures:

- **Clean** door and sealing surfaces of the oven.
- **Adjust** the receiving antenna of radio or television.
- **Move** the receiver away from the microwave oven.
- **Plug** the microwave oven into a different outlet so that the microwave oven and receiver are on different branch circuits.



## Microwave oven features

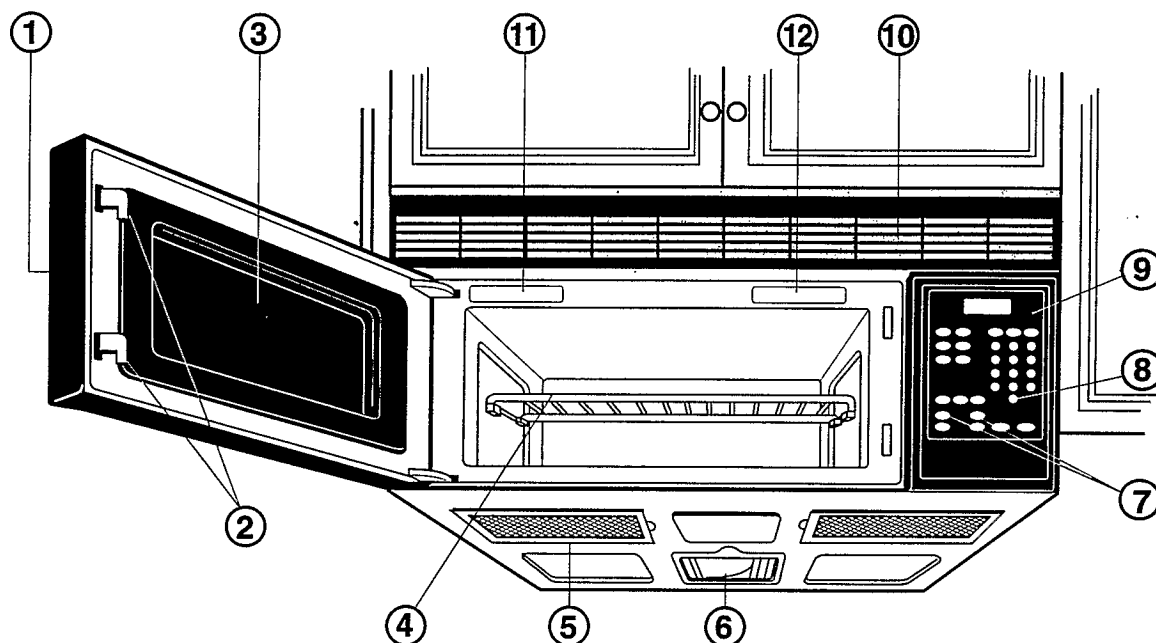

Your microwave oven is designed to make your cooking experience as enjoyable and productive as possible. To get you up and running quickly, the following is a list of the oven's basic features:

1. **Door Handle.** Pull to open door.
2. **Door Safety Lock System.** The oven will not operate unless the door is securely closed.
3. **Window with Metal Shield.** Shield prevents microwaves from escaping. It is designed as a screen to allow you to view food as it cooks.
4. **Two-Position Bi-Level Cooking Rack.** Use for extra space when cooking in more than one container at the same time. See page 15 or more information.
5. **Filter.** See page 34 for cleaning information.
6. **Cooktop/Countertop Light.** Turn on to light your cooktop or countertop or turn on as a night light. See page 14 for more information.
7. **Exhaust Fan and Cooktop Light Switches.** See page 14 for more information.
8. **Keep Warm**
9. **Control Panel.** Touch the pads on this panel to perform all functions. See pages 12, 13 for more information.
10. **Vent Grille.**
11. **Model and Serial Number Plate.**
12. **Cooking Guide Label.**



## Control panel features

Your microwave oven control panel lets you select the desired cooking function quickly and easily. All you have to do is touch the necessary Command Pad. The following is a list of all the Command and Number Pads located on the control panel. For more information, see pages 14-32.

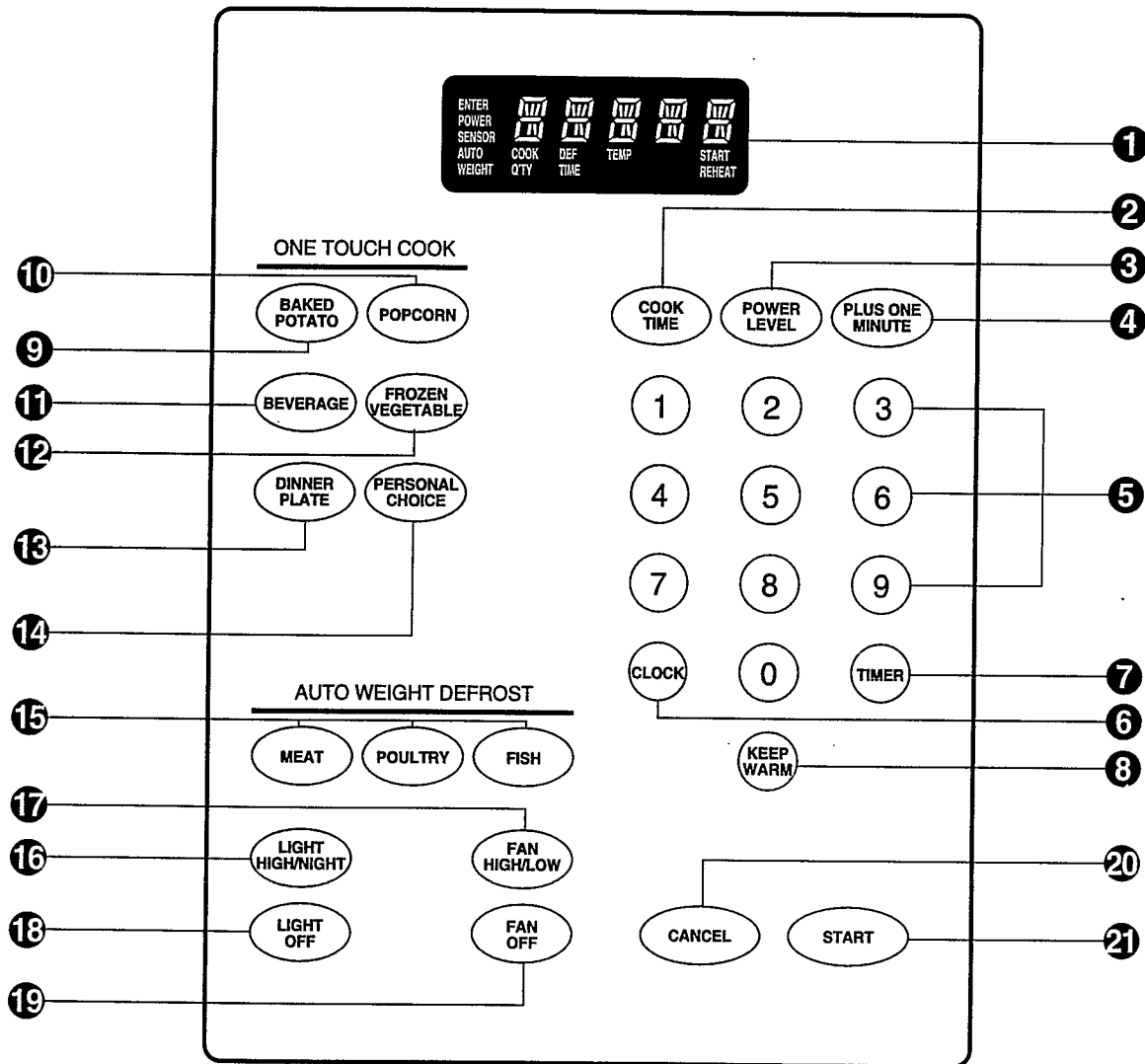

- 1. Display.** The Display includes a clock and indicators to tell you time of day, cooking time settings and cooking functions selected.
- 2. COOK TIME.** Touch this pad followed by Number Pads to set a cooking time. See pages 18, 20, and 21 for more information.

- 3. POWER LEVEL.** Touch this pad followed by a Number Pad to set the amount of microwave energy released to cook the food. The higher the number, the higher the microwave power or "cooking speed." See page 19 for more information. See the "Microwave cooking chart" on page 38 for specific Cook Powers to use for the foods you are cooking.

continued on next page





# GETTING TO KNOW YOUR MICROWAVE HOOD COMBINATION

4. **PLUS ONE MINUTE.** Touch this pad twice to cook for one minute, at 100% Power Level. See page 32 for more information.
  5. **NUMBER PADS.** Touch Number pads to enter cooking times, Power Levels, quantities or weights.
  6. **CLOCK.** Touch this pad to enter the correct time of day. See page 15 for more information.
  7. **TIMER.** Touch this pad to set the timer. See page 16 for more information.
  8. **KEEP WARM.** Touch this pad to keep hot, cooked foods safely warm in your microwave oven for up to 60 minutes. KEEP WARM can be used by itself, or it can automatically follow a cooking cycle. See page 26 for more information.
- ONE TOUCH COOK:**
9. **BAKED POTATO.** Touch this pad to cook from 1 to 4 potatoes. See page 28 for more information.
  10. **POPCORN.** Touch this pad when popping popcorn in your microwave oven. The oven will automatically heat for a preset time at a preset Cook Power. See page 29 for more information.
  11. **BEVERAGE.** Touch this pad to reheat one cup or two cups of a beverage. The oven will automatically heat for a preset time at a preset Cook Power. See page 30 for more information.
  12. **FROZEN VEGETABLE.** Touch this pad to heat packages of frozen vegetables. See page 30 for more information.
  13. **DINNER PLATE.** Touch this pad to reheat a dinner-sized plate of refrigerated food. The oven will automatically heat for a preset time at preset Cook Powers. See page 31 for more information.
  14. **PERSONAL CHOICE.** Touch this pad to recall one cooking instruction previously programmed into memory. See page 27 for more information.
  15. **AUTO WEIGHT DEFROST.** Meat, poultry, fish. Touch on pad to select food type and defrost food by weight. See page 22 for more information.
  16. **LIGHT HIGH/NIGHT.** Touch this pad to turn on the cooktop/countertop light and to choose its brightness. See page 14 for more information.

17. **FAN HIGH/LOW.** Touch this pad to change speed. See page 14 for more information.
18. **LIGHT OFF.** Touch this pad to turn off the cooktop/countertop light. See page 14 for more information.
19. **FAN OFF.** Touch this pad to turn off the fan. See page 14 for more information.
20. **CANCEL.** Touch this pad to erase an incorrect command, cancel a program during cooking, or to clear the Display. See below for more information.
21. **START.** Touch this pad to start a function. If you open the door after the oven begins to cook, retouch START. See below for more information.

## Audible signals

Audible signals are available to guide you when setting and using your oven:

- **A programming tone will sound** each time you touch a pad.
- **Three tones** signal the end of a cooking cycle and Timer.

## Interrupting cooking

You can stop the oven during a cycle by opening the door. The oven stops heating and the fan stops, but the light stays on. **To restart cooking, close the door and**

**TOUCH**

A button labeled "START" inside an oval border.

**If you do not want to continue cooking:**

- **Close the door** and the light goes off.

**OR**

• **TOUCH**

A button labeled "CANCEL" inside an oval border.



---

## Using the exhaust fan

The Fan High/Low and Fan Off pads control the 2-speed Exhaust Fan.



---

### 1. Choose fan speed.

Touch the pad once or more to select fan speed.

**NOTE:** If the temperature gets too hot around the microwave oven, the exhaust fan in the vent hood will automatically turn on at the LOW setting to protect the oven. It may stay on up to an hour to cool the oven. When this occurs, the Fan OFF Pad will not turn the fan off.

**TOUCH**



---

### 2. Turn off fan when desired.

**TOUCH**



---

## Using the cooktop/countertop light

The LIGHT HIGH/NIGHT and LIGHT OFF pads control the cooktop/countertop light.



---

### 1. Choose light.

Touch the pad once or more to select brightness.

**TOUCH**



---

### 2. Turn off light when desired.

**TOUCH**





## Using the bi-level cooking rack

The Bi-Level Cooking Rack (Part No. 5303284199) gives you extra space when cooking in more than one container at the same time. The metal rack can be turned upside-down to help fit taller containers on the bottom of the oven.

### Inserting the rack

First position

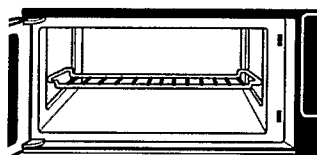

**First position:** Insert the rack securely into the rack supports on the side walls of the oven.

Second position

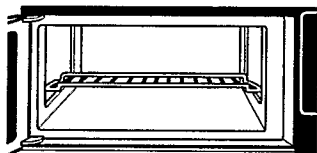

**Second position:** Turn rack upside-down when using a taller container on the bottom of the oven.

### **! WARNING**

#### Personal Injury and Product Damage Hazard

- Use hot pads when removing rack from oven after cooking to prevent burns. Rack may be hot.
- Do not store the metal rack in the oven. Arcing and damage to the oven can result if someone accidentally starts the oven.
- Do not operate the oven with the metal rack stored on the floor of the oven. Damage to the interior finish will result.
- Use rack only in the microwave oven.
- Do not use rack with browning dish.
- Do not let food container on rack touch the top or sides of the oven.
- Do not cook foods directly on rack without putting them in containers first.
- Do not place a metal cooking container on rack. Place a microwave-safe plate under container.

## Setting the clock

When your microwave oven is first plugged in or after a power failure, the Display will show "0". If a time of day is not set, "0" will show in the Display until you touch CLOCK.

### NOTES:

- **You can** only set the clock if the oven is not cooking food.
- **If you touch in** an incorrect time (for example 28:90) and touch CLOCK, one tone will sound. Enter the correct time.

### To set time:

#### 1. Choose setting.

TOUCH



YOU SEE



#### 2. Enter time of day.

Example for 2:00:

TOUCH



YOU SEE

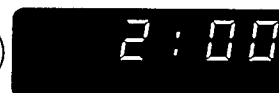



# GETTING TO KNOW YOUR MICROWAVE HOOD COMBINATION

## 3. Complete entry.

TOUCH



YOU SEE



## Using the Timer

You can use your microwave oven as a timer. Use the Timer for timing up to 99 minutes, 99 seconds.

### 1. Touch TIMER.

TOUCH



YOU SEE



### 2. Enter time to be counted down.

Example for 1 minute, 30 seconds:

**NOTE:** Touch START to count down the 3-digit time you have entered or touch CANCEL to clear the Display. To start over, touch TIMER and reenter desired time.

TOUCH

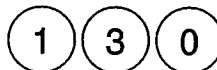

YOU SEE

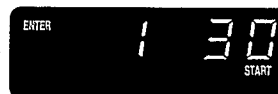

### 3. Start countdown.

TOUCH



YOU SEE

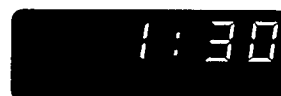

At end of countdown:

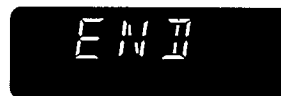

(three tones will sound)

### To cancel Timer:

During countdown:

TOUCH



YOU SEE



After countdown:



(time of day)





# Using Your Microwave Oven

This section gives you instructions for operating each function. Please read these instructions carefully.

In This Section		Page	Page
Getting the best cooking results .....	17	ONE TOUCH COOK PADS .....	27
Cooking at high cook power .....	18	Using PERSONAL CHOICE.....	27
Cooking at lower power levels .....	19	Using BAKED POTATO .....	28
Cooking with more than one cook cycle.....	21	Using POPCORN.....	29
Using AUTO WEIGHT DEFROST .....	22	Using BEVERAGE.....	30
Auto weight defrost chart .....	23	Using FROZEN VEGETABLE .....	30
Defrosting tips .....	25	Using DINNER PLATE .....	31
Using KEEP WARM .....	26	Using PLUS ONE MINUTE .....	32

## Getting the best cooking results

- **Although a new rating method\*** rates this oven at 850 watts, you may use a reliable cookbook and recipes developed for microwave ovens previously rated at 700-800 watts.
- **Always cook** food for the minimum recommended cooking time. If necessary, touch PLUS ONE MINUTE while the oven is operating or after it has completed the cooking cycle (see page 32 for more information). Then check for doneness to avoid overcooking the food.
- **Stir, turn over or rearrange food** being cooked about halfway through the cook time for most even doneness with all recipes.
- **If a glass cover is not available, use wax paper, paper towels or microwave approved plastic wrap. Turn back** a corner to vent steam during cooking.

\*IEC-705 Test Procedure. The IEC-705 Test Procedure is an internationally recognized method of rating microwave wattage output and does not represent an actual change to output power or cooking performance.



## Cooking at high cook power

1. Put food in oven and close the door.

2. Set cooking time.

TOUCH



YOU SEE



Example for 1 minute,  
30 seconds:

TOUCH



YOU SEE



3. Start oven.

TOUCH



YOU SEE



At end of cooking time:

YOU SEE

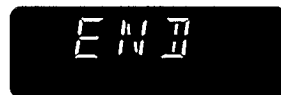

(three tones will sound)



## cooking at lower power levels

For best results, some recipes call for lower Power Levels. The lower the Power Level, the slower the cooking. Each Number Pad also stands for a different Power Level. Many microwave cookbook recipes tell you by number, percent or name which Power Level to use.

The following chart gives the Power Level each Number Pad stands for, and the power level name usually used. It also tells you when to use each Power Level.

POWER LEVEL	NAME	WHEN TO USE IT
Automatic 100% or full power	HIGH	Quick reheating of foods with high water content, such as beverages. If food contains eggs or cream, choose a lower power.
9=90% of full power		Heating large quantities of liquids, such as water or soup stock.
8=80% of full power		Reheating soups or casseroles.
7=70% of full power	MED-HIGH	Cooking and heating vegetables, fish, meat, etc. when you need a Power Level lower than HIGH or when food is cooking too fast.
6=60% of full power		Cooking requiring special care, such as for high protein sauces, cheese and egg dishes, and casseroles that need to finish cooking.
5=50% of full power	MED	Starting cakes which must be finished on HIGH power or finishing cooking of a large roast.
4=40% of full power		Simmering stews, reheating pastries.
3=30% of full power	MED-LOW, DEFROST	Defrosting of foods such as bread, shellfish, and precooked foods.
2=20% of full power		Defrosting and softening butter, cheese and ice cream.
1=10% of full power	LOW	Keeping one food serving warm.

**NOTE:** You can also use the Power Level pad as a second Timer by entering "0" for the Power Level. The oven will count down the cooking time you set without cooking.



# USING YOUR MICROWAVE OVEN

1. Put food in oven and close the door.

2. Set cooking time.

TOUCH



YOU SEE



Example for 7 minutes, 30 seconds:

TOUCH

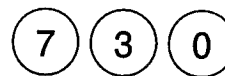

YOU SEE



3. Set Power Level.

TOUCH



YOU SEE



Example for 50% Power Level:

TOUCH



YOU SEE

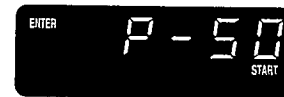

4. Start oven.

TOUCH



YOU SEE



At end of cooking time.

YOU SEE

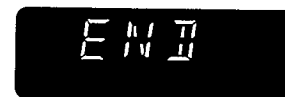

(three tones will sound)





## Cooking with more than one cook cycle

For best results, some recipes call for one Power Level for a certain length of time, and another Power Level for another length of time. Your oven can be set to change from one to another automatically, for up to three cycles.

You can also combine AUTO DEFROST and /or KEEP WARM with up to three cook cycles, for a total of five stages.

**1. Put food in oven and close the door.**

**2. Set cooking time for first cycle.**

TOUCH      YOU SEE



Example for 7 minutes, 30 seconds:

TOUCH      YOU SEE



**3. Set Power Level for first cycle.**

TOUCH      YOU SEE

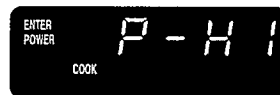

Example for 50% Power Level:

TOUCH      YOU SEE

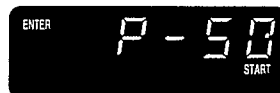

**4. Repeat Steps 2 and 3 to set cooking time and Power Level for the second cycle. A third cycle can be added.**

**5. Start oven.**

TOUCH      YOU SEE



After the first cycle is over, the next cycle will count down. (Two tones will sound between cycles.)

(first cycle)

At end of cooking time:

YOU SEE

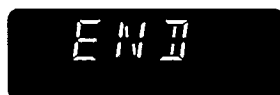

(three tones will sound)

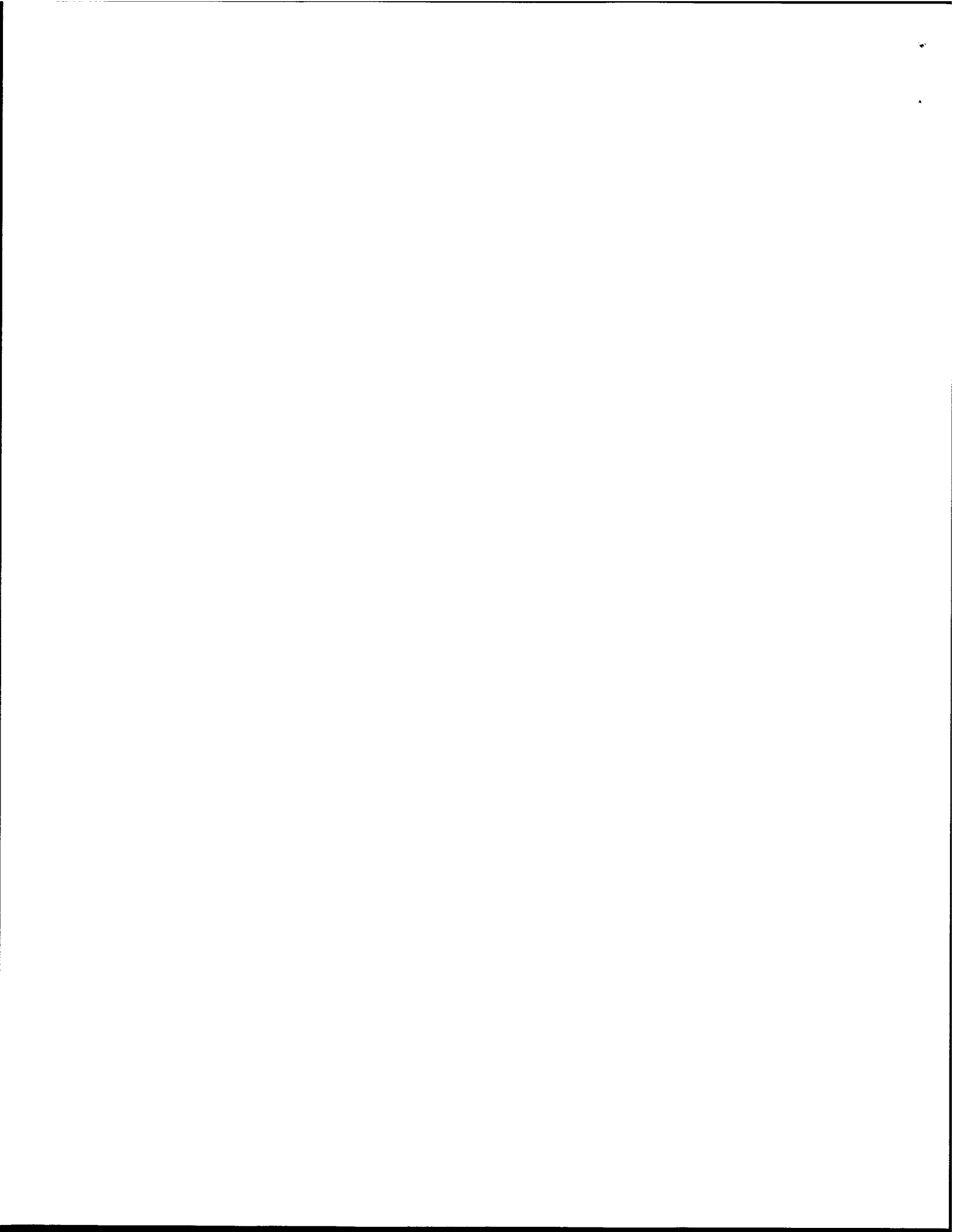

## Using AUTO WEIGHT DEFROST

Your microwave oven automatically defrosts a variety of meats at preset Power Levels for preset times. The 2-stage defrost cycle is programmed for meat, poultry, and fish. All you do is touch the Pad for the desired category and enter the weight of the items being defrosted. Your microwave oven does the rest.

### NOTES:

- See the "Auto weight defrost chart" on page 23 for defrosting directions for each food.
- To defrost items not listed in "Auto weight defrost chart" on page 23 and 24, use 30% Cook Power. Refer to a reliable cookbook for defrosting information.

1. Put frozen meat, poultry or fish in oven and close the door.

2. Choose food category

Example for meat:

TOUCH



YOU SEE



3. Enter food's weight (in pounds and tenths of a pound).

Example for 1.2 lbs:

TOUCH



YOU SEE



### NOTES:

- For converting fractions of a pound to decimals, see "Weight conversion chart" on page 25.
- If you enter an incorrect weight, touch MEAT, POULTRY, or FISH again and enter the correct weight.

4. Start oven.

TOUCH



YOU SEE



5. After half the cook time is over, five tones will sound. At this time,

Open door, turn over food, and shield any warm portions.

YOU SEE



**NOTE :** If you do not open the door, the Display will continue to countdown.

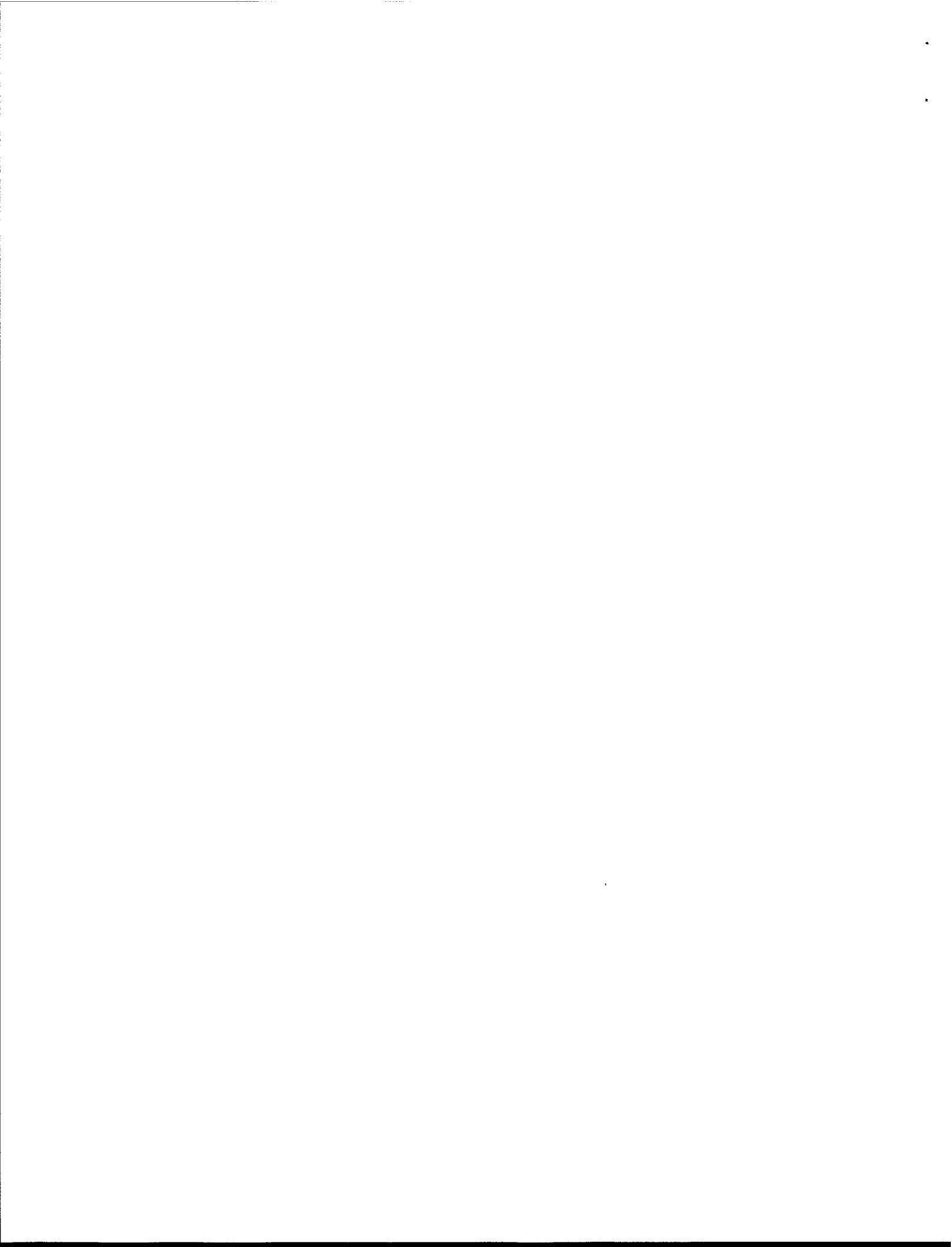

## 6. Restart oven.

TOUCH

YOU SEE



(time remaining)

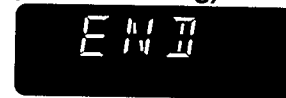

At end of defrosting time:

## Auto weight defrost chart

### Meat setting

FOOD	AT PAUSE	SPECIAL INSTRUCTIONS
<b>Beef</b>  Ground Beef, Bulk  Ground Beef, Patties Round Steak  Tenderloin Steak Stew Beef  Pot Roast, Chuck Roast Rib Roast  Rolled Rump Roast	Remove thawed portions with fork. Turn over. Return remainder to oven. Separate and rearrange.  Turn over. Cover warm areas with aluminum foil. Turn over. Cover warm areas with aluminum foil. Remove thawed portions with fork. Separate remainder. Return remainder to oven. Turn over. Cover warm areas with aluminum foil. Turn over. Cover warm areas with aluminum foil. Turn over. Cover warm areas with aluminum foil.	Meat of irregular shape and large, fatty cuts of meat should have the narrow or fatty areas shielded with foil at the beginning of a defrost cycle. Do not defrost less than 1/4 lb. Freeze in doughnut shape.  Do not defrost less than two 4 oz patties. Depress center when freezing. Place on a microwavable roasting rack.  Place on a microwavable roasting rack.  Place in a microwavable baking dish.  Place on a microwavable roasting rack. Place on a microwavable roasting rack. Place on a microwavable roasting rack.
<b>Lamb</b> Cubes for Stew Chops (1 inch thick)	Remove thawed portions with fork. Return remainder to oven. Separate and rearrange.	Place in a microwavable baking dish. Place on a microwavable roasting rack.
<b>Pork</b> Chops (1/2 inch thick) Hot Dogs Spareribs, Country-Style Ribs Sausage, Links Sausage, Bulk  Loin Roast, Boneless	Separate and rearrange.  Separate and rearrange. Turn over. Cover warm areas with aluminum foil.  Separate and rearrange.  Remove thawed portions with fork. Turn over. Return remainder to oven. Turn over. Cover warm areas with aluminum foil.	Place on a microwavable roasting rack.  Place on a microwavable roasting rack. Place on a microwavable roasting rack.  Place on a microwavable roasting rack.  Place in a microwavable baking dish.  Place on a microwavable roasting rack.



## Auto weight defrost chart (continued)

### Fish setting

FOOD	AT PAUSE	SPECIAL INSTRUCTIONS
<b>Fish</b> Fillets Steaks Whole	Turn over. Separate fillets when partially thawed. Separate and rearrange. Turn over.	Place in a microwavable baking dish. Carefully separate fillets under cold water. Place in a microwavable baking dish. Run cold water over to finish defrosting. Place in a microwavable baking dish. Cover head and tail with foil; do not let foil touch sides of microwave oven. Finish defrosting by immersing in cold water.
<b>Shell Fish</b> Crabmeat Lobster Tails Shrimp Scallops	Break apart. Turn over. Turn over and rearrange. Separate and rearrange. Separate and rearrange.	Place in a microwavable baking dish. Place in a microwavable baking dish. Place in a microwavable baking dish. Place in a microwavable baking dish.

### Poultry setting

FOOD	AT PAUSE	SPECIAL INSTRUCTIONS
<b>Chicken</b> Whole (up to 9.9 lbs) Cut Up	Turn over (finish defrosting breast-side down). Cover warm areas with aluminum foil. Separate pieces and rearrange. Turn over. Cover warm areas with aluminum foil.	Place chicken breast-side up on a microwavable roasting rack. Finish defrosting by immersing in cold water. Remove giblets when chicken is partially defrosted. Place on a microwavable roasting rack. Finish defrosting by immersing in cold water.
<b>Cornish Hens</b> Whole	Turn over. Cover warm areas with aluminum foil.	Place on a microwavable roasting rack. Finish defrosting by immersing in cold water.
<b>Turkey</b> Breast (under 6 lbs)	Turn over. Cover warm areas with aluminum foil.	Place on a microwavable roasting rack. Finish defrosting by immersing in cold water.





## Weight conversion chart

You are probably used to food weights as being in pounds and ounces that are fractions of a pound (for example 4 ounces equals  $\frac{1}{4}$  pound). However, in order to enter food weight in AUTO WEIGHT DEFROST, you must specify pounds and tenths of a pound.

If the weight on the food package is in fractions of a pound, you can use the following chart to convert the weight to decimals.

NUMBER AFTER DECIMAL		EQUIVALENT OUNCE WEIGHT
.10		1.6
.20		3.2
.25	One-Quarter Pound	4.0
.30		4.8
.40		6.4
.50	One-Half Pound	8.0
.60		9.6
.70		11.2
.75	Three-Quarters Pound	12.0
.80		12.8
.90		14.4
1.00	One Pound	16.0

## Defrosting tips

- **When using AUTO WEIGHT DEFROST**, the weight to be entered is the net weight in pounds and tenths of pounds (the weight of the food minus the container).
  - **Only use AUTO WEIGHT DEFROST** for raw food. AUTO WEIGHT DEFROST gives best results when food to be thawed is a minimum of 0°F (taken directly from a "true" freezer). If food has been stored in a refrigerator-freezer that does not maintain a temperature of 0°F or below, always program a lower food weight (for a shorter defrosting time) to prevent cooking the food.
  - **If the food is stored outside** the freezer for up to 20 minutes, enter a lower food weight.
  - **If the food is stored outside** the freezer for more than 20 minutes, and for defrosting ready-made food, defrost by time and power and let stand after defrosting.
  - **The shape of the package** alters the defrosting time. Shallow rectangular packets defrost more quickly than a deep block.
  - **Separate pieces** as they begin to defrost. Separated pieces defrost more easily.
  - **You can use small pieces** of aluminum foil to shield foods like chicken wings, leg tips, and fish tails, but the foil must not touch the side of the oven. Foil can damage the oven lining.
  - **Shield areas of food** with small pieces of foil if they start to become warm.
  - **For better results, a preset standing time** is included in the defrosting time.
- This may make the defrosting time seem longer than expected. (For more information on standing time, see "Microwave cooking tips" on page 39.)



## Using KEEP WARM

You can safely keep hot, cooked food warm in your microwave oven for up to 60 minutes. You can use KEEP WARM by itself, or to automatically follow a cooking cycle.

### NOTES:

- **KEEP WARM** operates for up to 60 minutes.
- **Opening** the oven door cancels KEEP WARM. Close the door and touch KEEP WARM, then touch START if additional KEEP WARM time is desired.
- **Food cooked covered** should be covered during KEEP WARM.
- **Pastry items** (pies, turnovers, etc.) should be uncovered during KEEP WARM.
- **Complete meals** kept warm on a dinner plate should be covered during KEEP WARM.
- **It is not recommended to use KEEP WARM** for more than 30 minutes. The quality of some foods will suffer with extended time.

1. Put hot, cooked food in oven and close the door.

2. Choose setting

TOUCH



YOU SEE



3. Start oven.

TOUCH



YOU SEE



To make KEEP WARM automatically follow another cycle:

- While you are touching in cooking instructions, touch KEEP WARM before touching START.  
OR
- After the oven starts operating, touch CANCEL once, touch KEEP WARM, and then touch START.
- When the last cooking cycle is over, you will hear two tones. "HOLD" will come on while the oven continues to run.
- You can set KEEP WARM to follow AUTO WEIGHT DEFROST, or multi-cycle cooking.



# One Touch Cook Pads

## Using PERSONAL CHOICE

PERSONAL CHOICE allows you to recall one cooking instruction previously placed in memory and begin cooking quickly. For example, if you eat a roll every morning program three cooking steps into PERSONAL CHOICE. You can heat your roll each morning by touching PERSONAL CHOICE.

PERSONAL CHOICE also allows you to program a function for another person to cook at a later time.

You can enter cooking instructions with up to three stages. (See cooking cycles, page 21.)





For example: Cooking at high power, followed by cooking at a lower power level, and then followed by KEEP WARM.

**NOTE:** You can reprogram PERSONAL CHOICE by repeating the instructions below. A power failure will erase your Personal Choice program.

### To program PERSONAL CHOICE:



#### 1. Set cooking time.

Example for 20 seconds:

<b>TOUCH</b>	<b>YOU SEE</b>
	
<b>TOUCH</b>	<b>YOU SEE</b>
 	

#### 2. Set cook Power Level.

Example for 50% cook power:

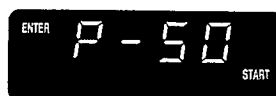
<b>TOUCH</b>	<b>YOU SEE</b>
	
<b>TOUCH</b>	<b>YOU SEE</b>
	

#### 3. Complete entry.

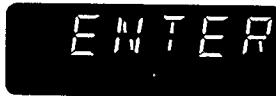
<b>TOUCH</b>	<b>YOU SEE</b>
	
for 2 seconds	



## To use PERSONAL CHOICE:

1. Put food in oven and close door.

2. Choose PERSONAL CHOICE.

The oven will cook according to your preprogrammed instructions.

TOUCH



YOU SEE



TOUCH



YOU SEE



(display counts down programmed cooking time)

At end of cooking time:

YOU SEE

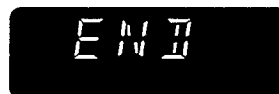

(three tones will sound)

## Using BAKED POTATO

BAKED POTATO lets you cook a potato by touching just one pad. You can choose from 8 oz to 32 oz.

You must touch once for 8 oz, twice for 16 oz, three times for 24 oz, four times for 32 oz, and if you touch five times, "8 oz" will show in display window again.

1. Place potato in oven and close door.

2. Choose BAKED POTATO.

Example for 8 oz.

TOUCH



YOU SEE



After 2 seconds:

YOU SEE

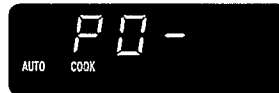

At end for heating time:

YOU SEE

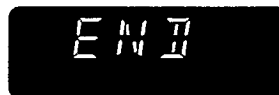

(three tones will sound)





## Using POPCORN

POPCORN lets you pop commercially packaged microwave popcorn by touching just one pad. Pop only one package at a time. If you are using a microwave popcorn popper, follow manufacturer's instructions.

You can set your microwave oven to pop different size bags of popcorn. You specify the setting by the number of times you touch POPCORN. To correctly set your microwave oven, follow this chart:

Bag Size-ounces	1.75	3.5
Touch POPCORN	once	twice

Cooking performance may vary with brand. Try several brands to decide which gives best popping results. For best results, use fresh bags of popcorn.

### 1. Place bag in oven and close door.

### 2. Choose POPCORN.

Example for 3.5 oz regular bags:

TOUCH



twice

YOU SEE



After 2 seconds, oven starts popping popcorn:

YOU SEE



The Display will alternate between "POP-" and "CORN" and then show the time remaining.

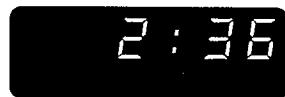

(time remaining)

At end of popping time:

YOU SEE

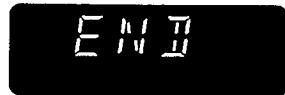

(three tones will sound)

## ! WARNING

### Fire and Burn Hazard

- Do not try to repop unpopped kernels and do not reuse popcorn bags. Fire may result.
- If you remove the rack right after popping popcorn, use oven mitts. It will be very hot and could burn you.



## Using BEVERAGE

BEVERAGE lets you heat a beverage by touching just one pad.

1. Place beverage in oven and close door.

2. Choose BEVERAGE.

To heat a cup of a beverage:

TOUCH



once

YOU SEE



To heat two cups of a beverage:

TOUCH



twice

YOU SEE



YOU SEE



YOU SEE

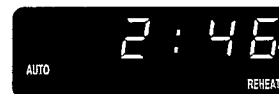

YOU SEE

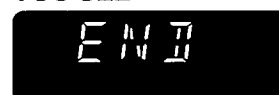

(three tones will sound)

In two seconds, the Display will start counting down.

Example for two full cups:

At end of heating time:

## Using FROZEN VEGETABLE

FROZEN VEGETABLE lets you cook a FROZEN VEGETABLE by touching just one pad. You can choose from 4 oz to 16 oz.

You must touch once for 4 oz, twice for 8 oz, three times for 12 oz, four times for 16 oz. If you touch five times, "4 oz" will show in display window again.

1. Place vegetable in oven and close door.

2. Choose FROZEN VEGETABLE.

TOUCH



YOU SEE





YOU SEE



YOU SEE

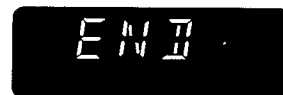

(three tones will sound)

## Using DINNER PLATE

DINNER PLATE lets you reheat a dinner-size plate of refrigerated food.

Place meat and bulky vegetables to the outside of the plate. Cover with wax paper.

1. Place plate of food in oven and close door.

2. Choose DINNER PLATE.

The word "8 oz" will show in display

The oven will begin cooking and the words "DINNER PLATE" will be displayed. The countdown time will follow.

TOUCH



YOU SEE



YOU SEE

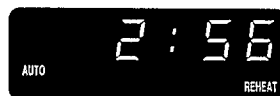
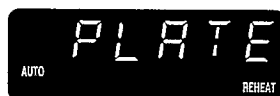
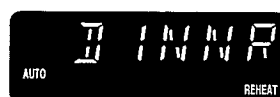

YOU SEE

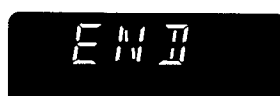

(three tones will sound)

At end of heating time:



## Using PLUS ONE MINUTE

The PLUS ONE MINUTE feature provides a convenient way to extend cooking time by one minute while the oven timer is counting down. It will add 30 seconds to time shown each time the pad is touched. No need to touch START. The oven will start immediately.

### NOTES:

- **To extend** cooking time in multiples of 30 seconds, touch PLUS ONE MINUTE repeatedly during cooking. After 3 minutes 30 seconds have been added, time will increase by one minute each time the PLUS ONE MINUTE key is touched.

- **You can enter** PLUS ONE MINUTE only after closing the door, after touching CANCEL, or during cooking.
- **You cannot use** PLUS ONE MINUTE with ONE TOUCH COOK, or AUTO WEIGHT DEFROST.
- **You cannot use** PLUS ONE MINUTE to start the oven if any program, other than the Timer, is on the Display.

### 1. Make sure food is in oven.

### 2. Choose PLUS ONE MINUTE.

Example for cooking for one minute:

TOUCH



twice

YOU SEE







# Caring For Your Microwave Hood Combination

To make sure your microwave oven looks good and works well for a long time, you should maintain it properly. For proper care, please follow these instructions carefully.

## Cleaning the microwave oven



Wipe often with warm, sudsy water and a sponge or paper towel.

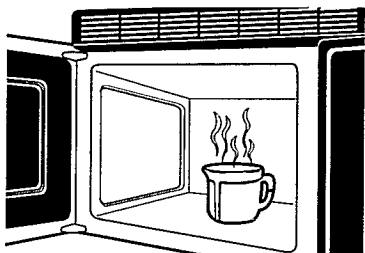

For stubborn soil, **boil** a cup of water in the oven for 2 or 3 minutes. Steam will soften the soil. To get rid of odors inside the oven, boil a cup of water with lemon juice.

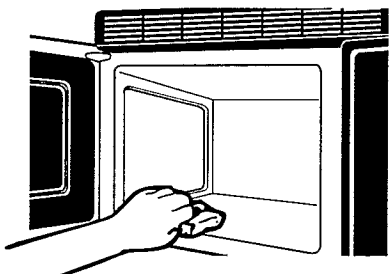

Be sure to keep the areas clean where the door and oven frame touch when closed. Use only mild, nonabrasive soaps or detergents applied with a sponge or paper towel when cleaning surfaces. Rinse well.

### !WARNING

#### Product Damage Hazard

Abrasive cleansers, steel-wool pads, gritty wash cloths, etc., can damage the control panel, and the interior and exterior oven surfaces. Use a sponge with a mild detergent or a paper towel with spray glass cleaner. Apply spray glass cleaner to paper towel; do not spray directly on oven.

#### Cleaning the bi-level cooking rack

- Wash by hand with a mild detergent and a soft or nylon scrub brush. Dry completely.
- Do not use abrasive scrubbers or cleansers to clean rack.



## Caring for the filters

The grease filters should be removed and cleaned often, at least once a month.

**NOTE:** If your microwave hood combination is installed to recirculate air, the charcoal filter (Part No. 5303284186) should be replaced every 6-12 months. The charcoal filter cannot be cleaned.

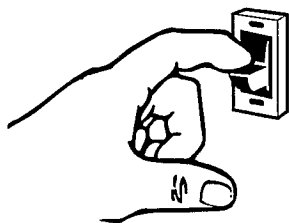

1. For your personal safety, **turn off** the electric power at the main power supply.

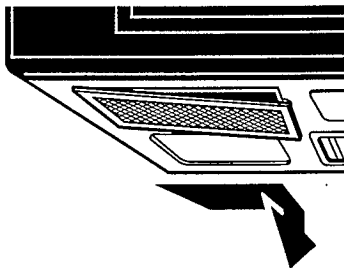

2. To **remove grease filters**, slide each filter to the side. **Pull** filters downward and **push** to the other side. The filter will drop out.

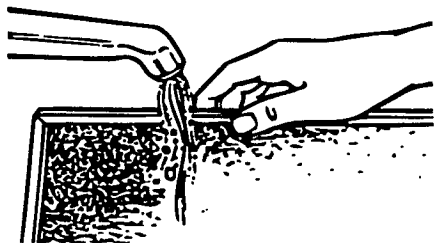

3. **Soak** grease filters in hot water and a mild detergent. **Scrub and swish** to remove embedded dirt and grease. **Rinse well and shake** to dry. **Do not use ammonia or place in a dishwasher.** The aluminum will darken.

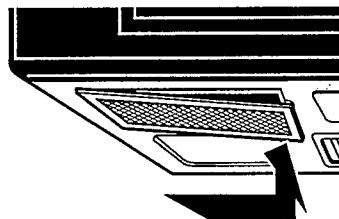

4. To **replace grease filters**, slide filter in the frame slot on one side of the opening. **Push** filter upward and **push** to the other side to lock into place.

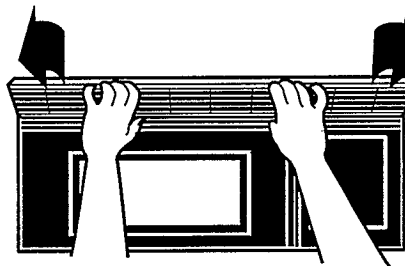

5. To **remove charcoal filter**: remove the vent cover mounting screws.

6. **Tip** the cover forward, then **lift out** to remove.

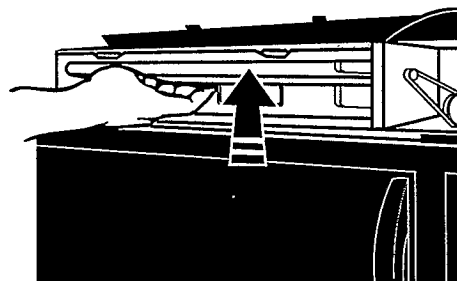

7. **Lift** the back of the charcoal filter. **Slide** the filter straight out.

continued on next page

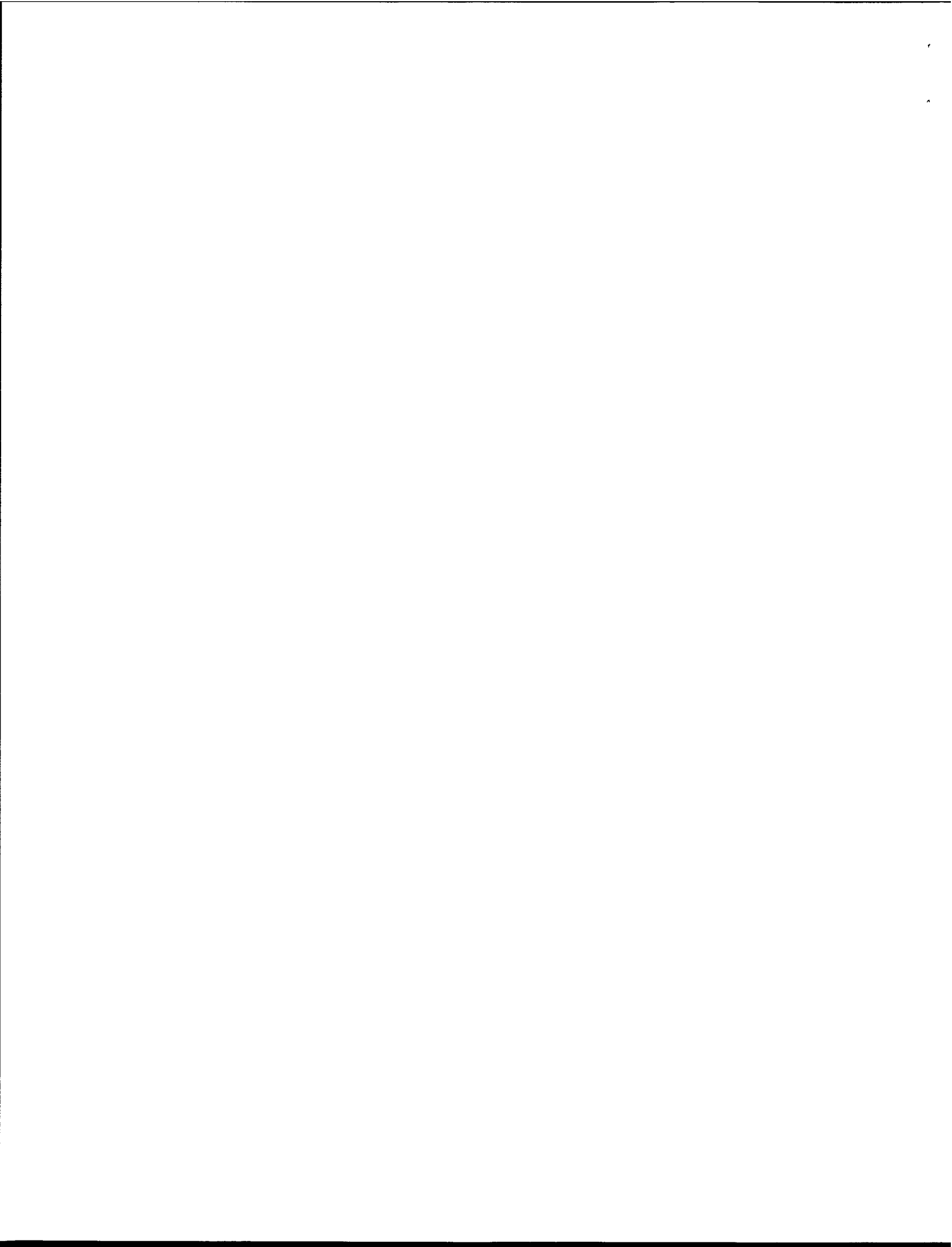

## CARING FOR YOUR MICROWAVE HOOD COMBINATION

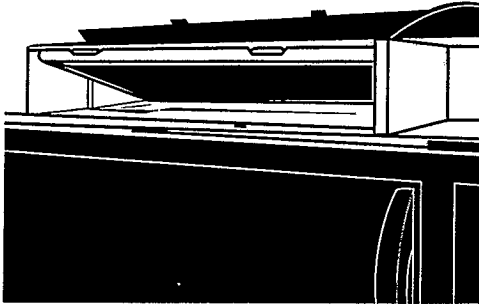

8. Slide a new charcoal filter into place. The filter should rest at the angle shown.

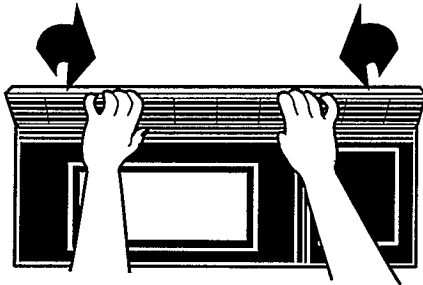

9. Slide the bottom of the vent cover into place. Push the top until it snaps into place. Replace the mounting screws.

10. Turn the power back on at the main power supply.

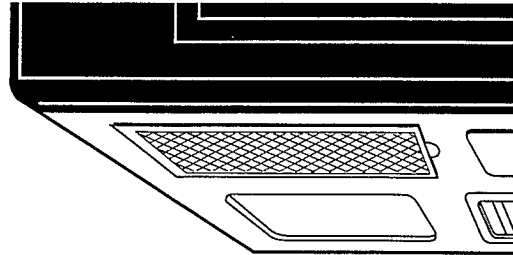

11. Do not operate the hood without the filters in place.

---

## Replacing the cooktop and oven lights

### **⚠ WARNING**

#### **Fire and Electrical Shock Hazard**

- Use only candelabra-base bulbs, 30-watt maximum. Failure to do so could result in fire.
- Turn off power at main power supply before replacing the light bulb. Failure to do so could result in electrical shock.

### The cooktop light

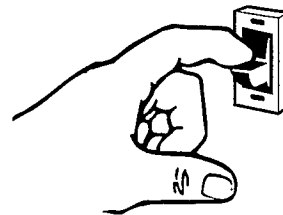

1. Turn off power at the main power supply.



# CARING FOR YOUR MICROWAVE HOOD COMBINATION

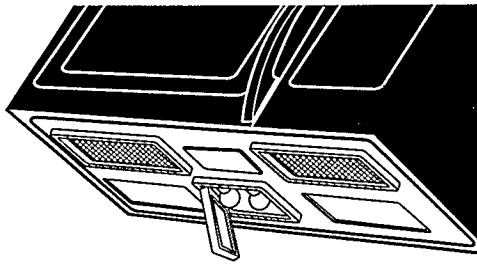

2. Remove the bulb cover mounting screws.
3. We recommend replacing bulb(s) with candelabra-base 30-watt bulb(s) available from your authorized dealer.

## The oven light

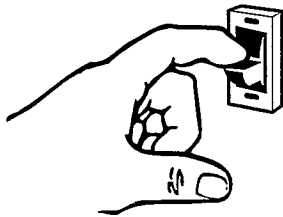

1. Turn off power at the main power supply.

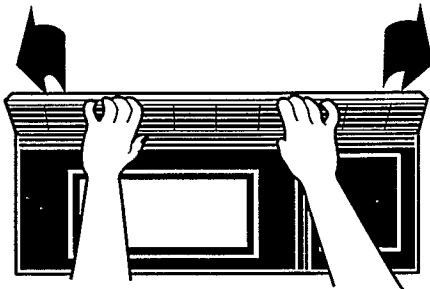

2. Remove the vent cover mounting screws.
3. Tip the cover forward, then lift out to remove.

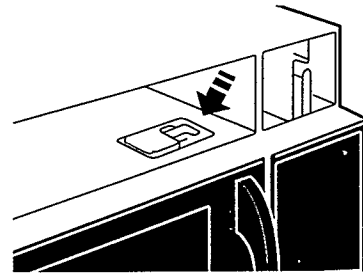

4. Remove bulb holder mounting screw.

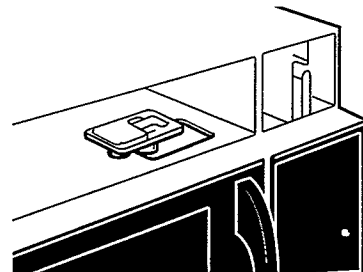

5. Lift up the bulb holder.
6. We recommend replacing the bulb with a candelabra-base 30-watt bulb available from your authorized dealer.
7. Replace the bulb holder and mounting screw.

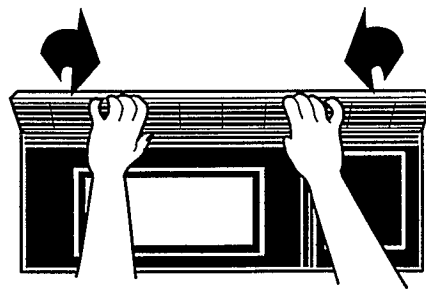

8. Slide the top of the vent cover into place. Push the bottom until it snaps into place. Replace the mounting screws. Turn the power back on at the main power supply.

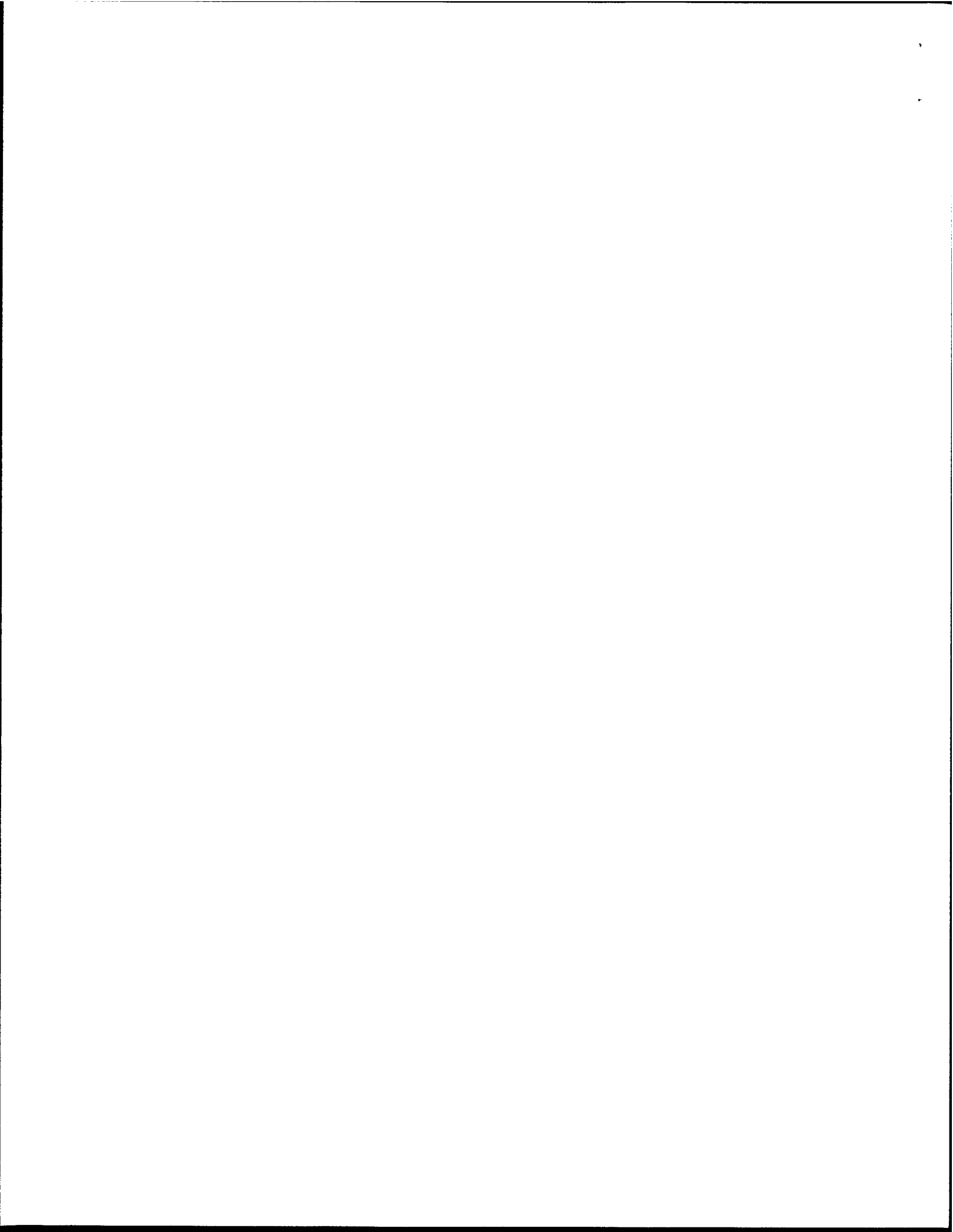



# Cooking Guide

## Reheating chart

Times are approximate and may need to be adjusted to individual taste.

ITEM	STARTING TEMP	TIME/POWER LEVEL	PROCEDURE
<b>Meat</b> (Chicken pieces, chops, hamburgers, meat loaf slices) 1 serving 2 serving	Refrigerated Refrigerated	1-2 min at 70% 2½-4½ min at 70%	Cover loosely.
<b>Meat Slices</b> (Beef, ham, pork, turkey) 1 or more servings	Room temp Refrigerated	45 sec-1 min per serving at 50% 1-3 min per serving at 50%	Cover with gravy or wax paper. Check after 30 sec per serving.
<b>Stirrable Casseroles and Main Dishes</b> 1 serving 2 serving 4-6 serving	Refrigerated Refrigerated Refrigerated	2-4 min at 100% 4-6 min at 100% 6-8 min at 100%	Cover. Stir after half the time.
<b>Nonstirrable Casseroles and Main Dishes</b> 1 serving 2 servings 4-6 servings	Refrigerated Refrigerated Refrigerated	5-8 min at 50% 9-12 min at 50% 13-16 min at 50%	Cover with wax paper.
<b>Soup, Cream</b> 1 cup 1 can (10¾ oz)	Refrigerated Room temp	3-4½ min at 50% 5-7 min at 50%	Cover. Stir after half the time.
<b>Soup, Clear</b> 1 cup 1 can (10¾ oz)	Refrigerated Room temp	2½-3½ min at 100% 4-5½ min at 100%	Cover. Stir after half the time.
<b>Pizza</b> 1 slice 1 slice 2 slices 2 slices	Room temp Refrigerated Room temp Refrigerated	15-25 sec at 100% 30-40 sec at 100% 30-40 sec at 100% 45-55 sec at 100%	Place on paper towel.
<b>Vegetables</b> 1 serving 2 servings	Refrigerated Refrigerated	¾-1½ min at 100% 1½-2½ min at 100%	Cover. Stir after half the time.
<b>Baked Potato</b> 1 2	Refrigerated Refrigerated	1-2 min at 50% 2-3 min at 50%	Cut potato lengthwise and then several times crosswise. Cover with wax paper.
<b>Breads</b> (Dinner or breakfast roll) 1 roll 2 rolls 4 rolls	Room temp Room temp Room temp	8-12 sec at 50% 11-15 sec at 100% 18-22 sec at 100%	Wrap single roll, bagel or muffin in paper towel. To reheat several, line plate with paper towel. Cover with another paper towel.
<b>Pie</b> Whole 1 slice	Refrigerated Refrigerated	5-7 min at 70% 30 sec at 100%	



# Microwave cooking chart

Times are approximate and may need to be adjusted to individual taste.

<b>MEATS, POULTRY, FISH, SEAFOOD</b>			<b>VEGETABLES (continued)</b>		
Allow standing time after cooking.			Cook at 100% Power.		
FOOD	POWER LEVEL	TIME	FOOD		TIME
Bacon	100%	45 sec to 1 min 15 sec per slice	Carrots (1 lb)		8-12 min
Ground Beef for Casseroles (1 lb)	100%	4-6 min	Cauliflower (medium head)		6-9 min
Hamburger Patties (2)	100%	1st side 2 min 2nd side 1½ to 2½ min	Corn on the Cob (2)		4-9 min
Hamburger Patties (4)	100%	1st side 2½ min 2nd side 2-3 min	(4)		6-16 min
Meat Loaf (1½ lbs)	100%	13-19 min	Potatoes, Baked (4 medium)		13-19 min
Chicken Pieces	100%	6-9 min/lb	Squash, Summer (1 lb)		3-8 min
Internal temperature should be 185°F after standing.			<b>OTHER</b>		
Turkey Breast	100% then 70%	5 min 8-12 min/lb	FOOD	POWER LEVEL	TIME
Internal temperature should be 185°F after standing.			Applesauce (4 servings)	100%	7-10 min
Fish Fillets (1lb)	100%	5-6 min	Baked Apples (4)	100%	4-6 min
Scallops and Shrimp (1lb)	100%	3½-5½ min	Chocolate (melt 1 square)	50%	1-2 min
<b>VEGETABLES</b>			Eggs, Scrambled (2)	100%	1 min 15 sec to 1 min 45 sec
Cook at 100% Power.			(4)		2-3 min
FOOD		TIME	Hot Cereals (1 serving)	100%	1½-5 min
Beans, Green or Yellow (1 lb)		6-12 min	(4 servings)		4½-7 min
Broccoli (1 lb)		6-10 min	Nachos (large plate)	50%	1½-2½ min
			Water for Beverage (1 cup)	100%	2½-4 min
			(2 cups)		4½-6 min



## Microwave cooking tips

### Amount of food

- **The more food** you want to prepare, the longer it takes. A rule of thumb is that a double amount of food requires almost double the time. If one potato takes four minutes to cook, you need about seven minutes to cook two potatoes.
- **If you want to cook two meals or containers of food** at the same time, you can do so with the Bi-Level Cooking Rack. For example, you can cook two frozen dinners or reheat two plates of food by placing one on the rack and one under the rack.

### Starting temperature of food

- **The lower the temperature** of the food being put into the microwave oven, the longer it takes to cook. Food at room temperature will be reheated more quickly than food at refrigerator temperature.

### Composition of food

- **Food with a lot of fat and sugar** will be heated faster than food containing a lot of water. Fat and sugar will also reach a higher temperature than water in the cooking process.
- **The more dense the food**, the longer it takes to heat. "Very dense" food like meat takes longer to reheat than lighter, more porous food like sponge cakes.

### Size and shape

- **Smaller pieces of food** will cook faster than larger pieces and same-shaped pieces of food cook more evenly than irregularly shaped foods.
- **With unevenly shaped foods**, the thinner parts will cook faster than the thicker areas. **Place** the thinner parts of chicken wings and legs in the center of the dish.

### Stirring, turning foods

- **Stirring and turning foods** distributes heat quickly to the center of the dish and avoids overcooking at the outer edges of the food.

### Covering food

#### Cover food to:

- **Reduce** splattering
- **Shorten** cooking times
- **Retain** food moisture

All coverings that allow microwaves to pass through are suitable.

### Releasing pressure in foods

- **Several foods** (for example: baked potatoes, sausages, egg yolks, and some fruits) are tightly covered by a skin or membrane. This can cause the food to burst from steam building up in them during cooking. To relieve the pressure and to prevent bursting, **prick** these foods with a fork, cocktail pick or toothpick.

### Using standing time

- **Always allow food to stand** for a while after cooking. Standing time after defrosting, cooking, or reheating always improves the result since the temperature will then be evenly distributed throughout the food.
- **When cooking in a microwave oven**, food continues to cook even when the microwave energy is turned off. Food is no longer cooked by microwaves, but it is still being cooked by the high heat left over from the microwave oven.
- **The length of the standing time** depends on the volume and density of the food. Sometimes it can be as short as the time it takes you to remove the food from the oven and take it to the serving table. However, with larger, denser food, the standing time may be as long as 10 minutes. During standing time, the internal food temperature will rise as much as 46°F as the food finishes cooking.

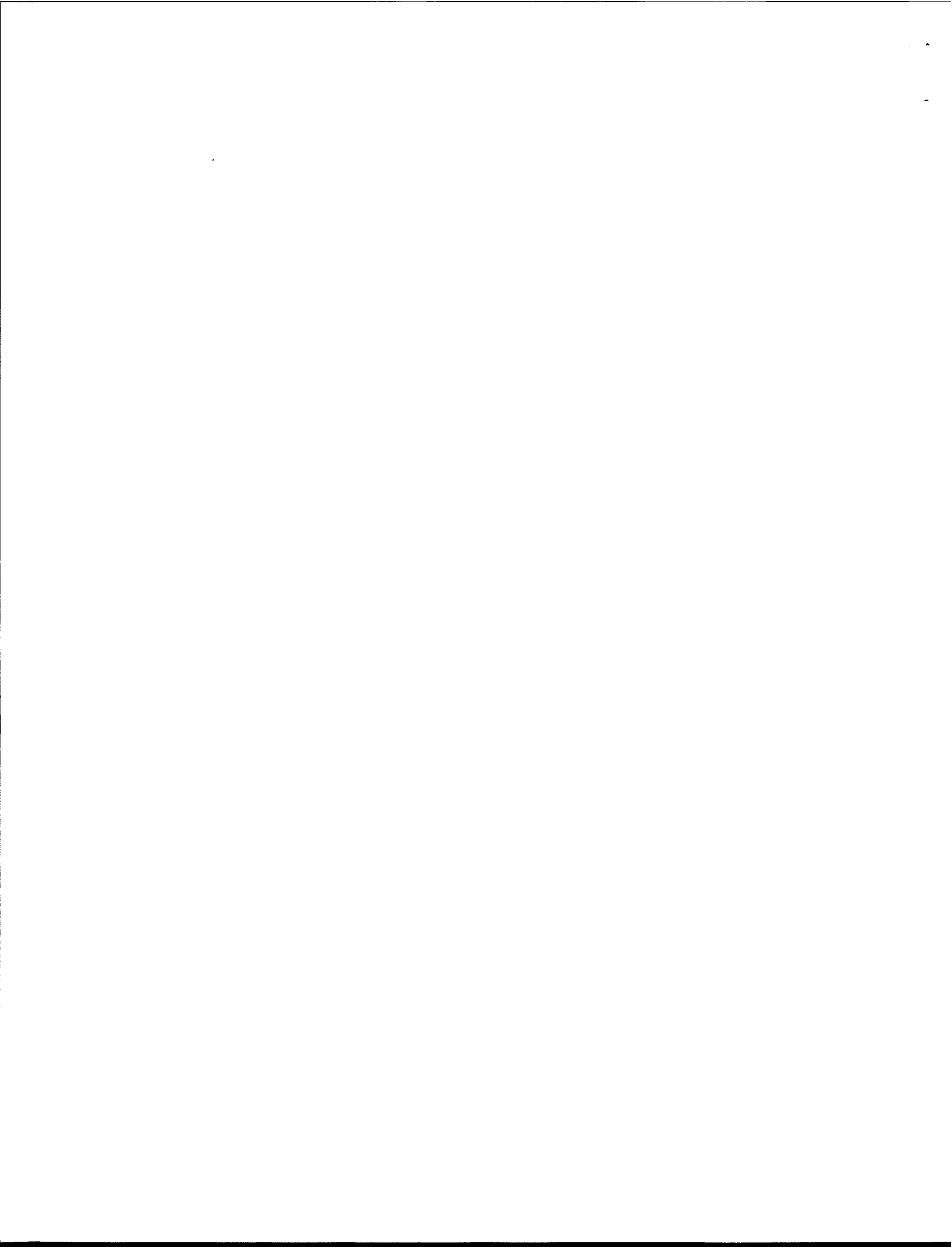

## Arranging food

For best results, distribute food evenly on the plate. You can do this in several ways:

- **If you are cooking several items of the same food**, such as baked potatoes, **place** them in a ring pattern for uniform cooking.
- **When cooking foods of uneven shapes or thickness**, **place** the smaller or thinner area of the food towards the center of the dish where it will be heated last.
- **Arrange uneven foods**, such as fish, in the oven with the tails to the center.
- **If you are saving a meal in the refrigerator** or “plating” a meal for reheating, **arrange** the thicker, denser foods to the outside of the plate and the thinner or less dense foods in the middle.
- **Place thin slices of meat** on top of each other or interlace them.
- **Place thicker slices of meat**, such as meat loaf and sausages, close to each other.
- **Reheat gravy or sauce** in a separate container.
- **When you cook or reheat whole fish**, **score** the skin — this prevents cracking.
- **Shield the tail and head of whole fish** with small pieces of foil to prevent overcooking and ensure the foil does not touch the sides of the oven.
- **Do not** let food or container touch the top or sides of the oven. This will prevent possible arcing.

## Using aluminum foil

Metal containers usually should not be used in a microwave oven. There are, however, some exceptions. If you have purchased food which is prepackaged in an aluminum foil container, then refer to the instructions on the package. It is possible to use disposable containers, but it generally takes longer and the final result will not be as good as if food were placed in plastic or paper containers.

If you use aluminum containers without package instructions, follow these guidelines:

- **Place** container in a glass bowl and add some water so that it covers the bottom of the container, not more than 1/4 inch high. This ensures even heating of the container bottom.
- **Always remove** the lid to avoid damage to the oven.
- **Use only** undamaged containers.
- **Do not** use containers taller than 3/4"
- **Container must be** half filled.
- **To avoid sparking**, there must be a minimum 1/4" between the aluminum container and the walls of the oven and also between two aluminum containers.
- **Thickness of the food layer** must be greater than thickness of the aluminum.
- **Reheating food** in aluminum foil containers usually takes up to double the time compared to reheating in plastic, glass, china, or paper containers. The time when food is ready will vary a great deal.
- **Let food stand** for 2-3 minutes after heating so that heat is spread evenly throughout container.

## Cooking you should not do in your microwave oven

- **Do not** do canning of foods in the oven. Closed glass jars may explode, resulting in damage to the oven or possible personal injury.
- **Do not** use the oven to sterilize objects (baby bottles, etc.). It is difficult to maintain the high temperature required for safe sterilization.





# Questions And Answers

QUESTIONS	ANSWERS
Can I use a rack in my microwave oven so that I may reheat or cook on two levels at a time?	You can use a rack only if rack is supplied with your microwave oven. Use of any rack not supplied with the microwave oven can result in poor cooking performance and/or arcing.
Can I use either metal or aluminum pans in my microwave oven?	Useable metal includes aluminum foil for shielding (use small, flat pieces), small skewers and shallow foil trays (if tray is 3/4 inch deep and filled with food to absorb microwave energy). Never allow metal to touch walls or door. (For more information, see page 40.)
Sometimes the door of my microwave oven appears wavy. Is this normal?	This appearance is normal and does not affect the operation of your oven.
What are the humming noises that I hear when my microwave oven is operating?	You hear the sound of the transformer when the magnetron tube cycles on.
Why does the dish become hot when I microwave food in it? I thought that this should not happen.	As the food becomes hot it will conduct the heat to the dish. Be prepared to use hot pads to remove food after cooking.
What does "standing time" mean?	"Standing time" means that food should be taken out of the oven and covered for additional time after cooking. This process allows the cooking to finish, saves energy and frees the oven for another purpose.
Can I pop popcorn in my microwave oven? How do I get the best results?	Yes. Pop packaged microwave popcorn following manufacturer's guidelines or use the preprogrammed Popcorn pad. Do not use regular paper bags. Use the "listening test" by stopping the oven as soon as the popping slows to a "pop" every one or two seconds. Do not try to repop unpopped kernels. You can also use special microwave poppers. When using a popper, be sure to follow manufacturer's directions. Do not pop popcorn in glass utensils.
Why does steam come out of the air exhaust vent?	Steam is normally produced during cooking. The microwave oven has been designed to vent this steam out the top vent.



# If You Need Assistance Or Service

This section is designed to help you save the cost of a service call. Part 1 of this section outlines possible problems, their causes, and actions you can take to solve each problem.

Parts 2 and 3 tell you what to do if you still need assistance or service. When calling our Service Center for help, please provide a detailed description of the problem, your appliance's complete model and serial numbers and the purchase date. (See page 3.) This information will help us respond properly to your request.

## 1. Before calling for assistance...

Performance problems often result from little things you can find and fix without tools of any kind. Please check the chart below for problems you can fix. It could save you the cost of a service call.

<b>PROBLEM</b>	<b>POSSIBLE CAUSE</b>	<b>SOLUTION</b>
<b>Nothing will operate</b>	A household fuse has blown or a circuit breaker has tripped. The electric company has experienced a power failure.	Replace household fuse or reset circuit breaker. Check electric company for a power failure.
<b>The microwave oven will not run</b>	You are using the oven as a timer. The door is not firmly closed and latched. You did not touch START. You did not follow directions exactly.  An operation that was programmed earlier is still running.	Touch CANCEL to cancel the Minute Timer. Firmly close and latch door. Touch START. Check instructions for the function you are operating. Touch CANCEL to cancel previous programming.
<b>Microwave cooking times seem too long</b>	The electric supply to your home or wall outlets is low or lower than normal.  The Power Level is not at the recommended setting. There is not enough cooking time for the amount of food being cooked.	Your electric company can tell you if the line voltage is low. Your electrician or service technician can tell you if the outlet voltage is low.  Check "Microwave cooking chart" on page 38. Allow for more time when cooking more food at one time.
<b>The Display shows a time counting down but the oven is not cooking</b>	The oven door is not closed completely. You have set the controls as a minute timer.	Completely close oven door.  Touch CANCEL to cancel the Minute Timer.
<b>You do not hear the Programming Tone</b>	The command is not correct.	Re-enter command.







# FRIGIDAIRE OVER-THE-RANGE MICROWAVE WARRANTY

Your Frigidaire product is protected by this warranty

	WARRANTY PERIOD	FRIGIDAIRE, THROUGH ITS AUTHORIZED SERVICERS, WILL:	THE CONSUMER WILL BE RESPONSIBLE FOR:
<b>FULL ONE-YEAR WARRANTY</b>	One year from original purchase date.	Pay all costs for repairing or replacing any parts of this appliance which prove to be defective in materials or workmanship.	Costs of service calls that are listed under <b>NORMAL RESPONSIBILITIES OF THE CONSUMER.*</b>
<b>EXTENDED LIMITED SECOND-YEAR WARRANTY</b>	Second year from original purchase date.	Provide a replacement for any part which proves to be defective in materials or workmanship.	Cost of shipping the replacement part to the nearest authorized servicer, and for all labor and service charges.
<b>EXTENDED LIMITED 2ND - 10TH YEAR WARRANTY (Magnetron Tube)</b>	Second through tenth years from original purchase date.	Provide a replacement for any magnetron tube which fails due to a defect in materials or workmanship.	Cost of shipping the replacement part to the nearest authorized servicer, and for all labor and service charges.
<b>LIMITED WARRANTY (Applicable to the State of Alaska)</b>	Time periods listed above.	All of the provisions of the full and limited warranties above and the exclusions listed below apply.	Costs of the technician's travel to the home and any costs for pick up and delivery of the appliance required because of service.

Your appliance is warranted by Frigidaire Company, a division of White Consolidated Industries, Inc. We authorize no person to change or add to any of our obligations under this warranty. Our obligations for service and parts under this warranty must be performed by Frigidaire Company Consumer Services or an authorized Frigidaire servicer.

## \*NORMAL RESPONSIBILITIES OF THE CONSUMER

**This warranty applies only to products in ordinary household use, and the consumer is responsible for the items listed below:**

1. Proper use of the appliance in accordance with instructions provided with the product.
2. Proper installation by an authorized servicer in accordance with instructions provided with the appliance and in accordance with all local plumbing, electrical and/or gas codes.
3. Proper connection to a grounded power supply of sufficient voltage, replacement of blown fuses, repair of loose connections or defects in house wiring.
4. Expenses for making the appliance accessible for servicing, such as removal of trim, cabinets, shelves, etc., which are not a part of the appliance when it was shipped from the factory.
5. Damages to finish after installation.
6. Replacement of light bulbs and/or fluorescent tubes (on models with these features).

## EXCLUSIONS

**This warranty does not cover the following:**

1. CONSEQUENTIAL OR INCIDENTAL DAMAGES SUCH AS PROPERTY DAMAGE AND INCIDENTAL EXPENSES RESULTING FROM ANY BREACH OF THIS WRITTEN OR ANY IMPLIED WARRANTY.  
*Note: Some states do not allow the exclusion or limitation of incidental or consequential damages, so this limitation or exclusion may not apply to you.*
2. Service calls which do not involve malfunction or defects in workmanship or material, or for appliances not in ordinary household use. The consumer shall pay for such service calls.
3. Damages caused by services performed by persons other than authorized Frigidaire servicers; use of parts other than Frigidaire Company Genuine Renewal Parts; obtained from persons other than such servicers; or external causes such as abuse, misuse, inadequate power supply or acts of God.
4. Products with original serial numbers that have been removed or altered and cannot be readily determined.

## IF YOU NEED SERVICE

Keep your bill of sale, delivery slip, or some other appropriate payment record. The date on the bill establishes the warranty period should service be required. If service is performed, it is in your best interest to obtain and keep all receipts. This written warranty gives you specific legal rights. You may also have other rights that vary from state to state. Service under this warranty must be obtained by following these steps, in order:

1. Contact the Frigidaire Company Consumer Services or an authorized Frigidaire servicer.
2. If there is a question as to where to obtain service, call or write our Consumer Relations Department at:

Frigidaire  
P.O. Box 7181  
Dublin, Ohio 43017  
(800) 451-7007



Product features or specifications as described or illustrated are subject to change without notice. All warranties are made by White Consolidated Industries, Inc. This warranty applies only in the 50 states of the U.S.A. and Puerto Rico.

