

OLYMPUS®

DIGITAL VOICE RECORDER

DS-2500

INSTRUCTIONS

ENGLISH	1
FRANÇAIS	65
ESPAÑOL	129

Thank you for purchasing an Olympus
Digital Voice Recorder.

Please read these instructions for information
about using the product correctly and safely.
Keep the instructions handy for future reference.

To ensure successful recordings, we recommend that
you test the record function and volume before use.

EN

Introduction

- The contents of this document may be changed in the future without advanced notice. Contact our Customer Support Center for the latest information relating to product names and model numbers.
- The illustration of the screen and the recorder shown in this manual may differ from the actual product. The utmost care has been taken to ensure the integrity of this document, but if you find a questionable item, error or omission, please contact our Customer Support Center.
- Any liability for passive damages or damage of any kind occurred due to data loss incurred by a defect of the product, repair performed by the third party other than Olympus or an Olympus authorized service station, or any other reason is excluded.

Trademarks

- Microsoft and Windows are registered trademarks of Microsoft Corporation.
- Macintosh is a trademark of Apple Inc.
- Intel and Pentium are registered trademarks of Intel Corporation.
- SD and SDHC are trademarks of SD Card Association.

Other product and brand names mentioned herein may be the trademarks or registered trademarks of their respective owners.



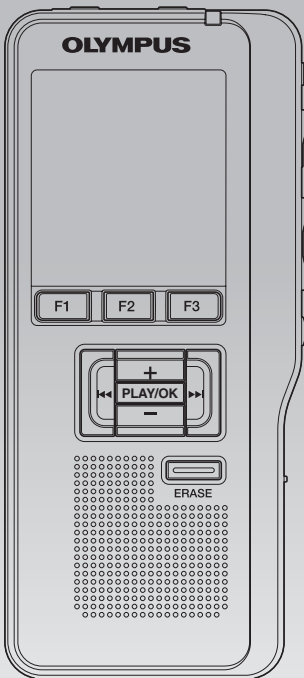

INDEX

Table of contents	P.4
Safe and proper usage	P.5
Getting started	P.8
Basic operations	P.22
Advanced operations	P.36
Managing files on your PC	P.53
Other practical use methods	P.59
Other information	P.60

1

2

3

4

5

6

Table of contents

Introduction

Table of contents	4
Safe and proper usage	5

Getting started

Main features	8
Memory card	9
Identification of parts	10
Display status indicators (LCD panel)	11
Power supply	12
Inserting batteries	12
Cautions concerning the battery	12
Battery settings	13
Charging by connecting to a computer via USB	14
Connecting the USB-type AC adapter (optional) to charge	15
Turning on/off the power	17
Power Save Mode (Power Save)	17
HOLD	18
Inserting and ejecting a SD card	19
Setting time and date [Time & Date]	20
Changing the time and date	21

Basic operations

Recording	22
New recording	23
Overwrite recording	24
Insert recording	25
Recording modes [Rec Mode]	26
Microphone sensitivity [Mic Sense]	27
Using the Variable Control Voice Actuator [VCVA]	28
Recording monitor	29
Playback	30
Erasing	32
Erasing a file	32
Erasing all files in a folder	33
Partially erasing a file	34

Advanced operations

Selecting folders and files	36
Displaying file information [Information]	37
Index marks	38
Menu list	39
Learning to use the menu	41
Locking files [Lock]	42
Backlight [Backlight]	43
LCD Contrast adjustment [Contrast]	44
LED [LED]	45
Language [Language]	46
System sounds [Beep]	47
Changing the USB class [USB Settings]	48
Formatting the card [Format]	50
Check system information [System info.]	52

Managing files on your PC

DSS Player software	53
Minimum requirement	53
Installing software	54
Uninstalling software	55
Using online help	55
Connecting recorder to PC	56
Connecting to your PC using the USB cable	56
Disconnecting from your PC	57
Running DSS Player Software	58

Other practical use methods

Using as external memory of the computer	59
--	----

Other information

Alarm message list	60
Troubleshooting	61
Technical assistance and support	62
Accessories (optional)	63
Specifications	64

Safe and proper usage

Before using your new recorder, read this manual carefully to ensure that you know how to operate it safely and correctly. Keep this manual in an easily accessible location for future reference.

- The warning symbols indicate important safety related information. To protect yourself and others from personal injury or damage to property, it is essential that you always read the warnings and information provided.



Danger

If the product is used without observing the information given under this symbol, serious injury or death may result.



Warning

If the product is used without observing the information given under this symbol, injury or death may result.



Caution

If the product is used without observing the information given under this symbol, minor personal injury, damage to the equipment, or loss of valuable data may result.

Convention used in this manual

- The word “card” is used to refer to the SD card.
- The word “DSS Player” is used to refer to the DSS Player Standard Dictation Module in Windows environment and DSS Player in Apple Macintosh environment.
- The Notes at the bottom of a page are used for additional information, exceptions, or related events.
- Words in uppercase form such as PLAY or REC are used to describe a function or button on the recorder.

Caution for usage environment

- **To protect the high-precision technology contained in this product, never leave the recorder in the places listed below, no matter if in use or storage:**
- Places where temperatures and/or humidity are high or go through extreme changes. Direct sunlight, beaches, locked cars, or near other heat sources (stove, radiator, etc.) or humidifiers.
- Near flammable items or explosives.
- In wet places, such as bathrooms or in the rain.
- In places prone to strong vibrations.
- **Never drop the recorder or subject it to severe shocks or vibrations.**
- The recorder may malfunction if it is used in a location where it is subject to a magnetic/ electromagnetic field, radio waves, or high voltage, such as near a TV set, microwave, video game, loud speakers, large monitor unit, TV/radio tower, or transmission towers. In such cases, turn the recorder off and on again before further operation.
- Avoid recording or playing back near cellular phones or other wireless equipment, as they may cause interference and noise. If you experience noise, move to another place, or move the recorder further away from such equipment.
- Do not use organic solvents such as alcohol and lacquer thinner to clean the unit.

Warning regarding data loss:

- Recorded content in memory may be destroyed or erased by operating mistakes, unit malfunction, or during repair work. It is recommended to back up and save important content to other media such as a computer hard disk.
- Any liability for passive damages or damage of any kind occurred due to data loss incurred by a defect of the product, repair performed by the third party other than Olympus, an Olympus authorized service station or any other reason is excluded from the Olympus liability.

Handling the recorder

Warning:

- Keep the recorder out of the reach of children and infants to prevent the following dangerous situation that could cause serious injury:
 - ① Accidentally swallowing the battery, cards or other small parts.
 - ② Accidentally being injured by the moving parts of the recorder.
- **Do not disassemble, repair or modify the unit yourself.**
- Use SD/SDHC memory cards only. Never use other types of cards.
If you accidentally insert another type of card into the recorder, contact an authorized distributor or service center. Do not try to remove the card by force.
- **Do not operate the unit while operating a vehicle.**

Caution:

- **Stop using the recorder immediately if you notice any unusual odors, noise, or smoke around it.**
Never remove the battery with bare hands, which may cause a fire or burn your hands.
- **Do not leave the recorder in places where it may be subject to extremely high temperatures.**
Doing so may cause parts to deteriorate and, in some circumstances, cause the recorder to catch fire. Do not use the charger or AC adapter if it is covered. This could cause overheating, resulting in fire.
- **Handle the recorder with care to avoid getting a low-temperature burn.**
- When the recorder contains metal parts, overheating can result in a low-temperature burn. Pay attention to the following:
- When used for a long period, the recorder will get hot. If you hold on to the recorder in this state, a low-temperature burn may be caused.

- In places subject to extremely cold temperatures, the temperature of the recorder's body may be lower than the environmental temperature. If possible, wear gloves when handling the recorder in cold temperatures.

Battery handling precautions

Danger:

- **Do not solder lead wires or terminals directly onto a battery or modify it.**
- **Do not connect the ⊕ and ⊖ terminals together. This may cause fire, overheating or electric shock.**
- **When carrying or storing the battery, be sure to put it in the provided case to protect its terminals. Do not carry or store the battery with any metal objects (such as key rings). If this warning is not followed, fire, overheating or electric shock may occur.**
- **Do not connect the batteries directly to a power outlet or a cigarette lighter of an automobile.**
- **Do not insert the batteries with their ⊕ and ⊖ terminals reversed.**
- **If any liquid from a battery gets into your eyes, promptly wash it off with clean water and consult your doctor at once.**
- **There is a hole from which gas escapes on the ⊕ terminal. Do not cover or block it.**

Warning:

- **The battery should never be exposed to flame, heated, short-circuited or disassembled.**
- **Do not attempt to recharge alkaline, lithium or any other non-rechargeable batteries.**
- **Never use any battery with a torn or cracked outer cover.**

- **Keep batteries out of the reach of children.**
- **If you notice anything unusual when using this product, such as abnormal noise, heat, smoke, or a burning odor:**
 - ① remove the battery immediately, taking care not to burn yourself, and;
 - ② call your dealer or local Olympus representative for service.
- **Do not expose the rechargeable batteries to water. Do not allow water to contact the terminals.**
- **Do not remove or damage the battery insulating sheet.**
- **Do not use the batteries if you find something wrong with them such as leakage, color change or deformity.**
- **Unplug the charger if the charging is still incomplete after the specified time it should take.**
- **Should any battery liquid get on skin or clothing, promptly wash it off with clean water.**
- **Keep batteries away from fire.**

Caution:

- **Do not subject batteries to strong shocks.**
- **Do not use batteries of different types, voltages, and/or brand names.**
- **Rechargeable battery is exclusively for use with Olympus digital voice recorder DS-2500.**
 - There is a risk of explosion if the battery is replaced with the incorrect battery type.
 - Dispose of the used battery following the instructions.
 - Please recycle batteries to help save our planet's resources. When you throw away dead batteries, be sure to cover their terminals and always observe local laws and regulations.
- **Always charge a rechargeable battery when using it for the first time, or if it has not been used for a long period.**
- **Rechargeable batteries have limited lifetime. When the operating time becomes shorter even if the rechargeable battery is fully charged, replace it with a new one.**

LCD monitor

- The LCD used for the monitor is made with high-precision technology. However, black spots or bright spots of light may appear on the LCD monitor. Due to its characteristics or the angle at which you are viewing the monitor, the spot may not be uniform in color and brightness. This is not a malfunction.

Memory Card

Warning:

- **Do not touch the card contacts. This may damage the card.**
- **Do not place the card in locations with static electricity.**
- **Store the card in a location that is out of the reach of children. In case of accidental ingestion, consult a physician immediately.**

Main features

1

Main features

- Support type of memory: SD card (E38 P.9).
- Three programmable smart buttons F1, F2 and F3.
- Recording and storing voice in Digital Speech Standard Pro (DS2 format).
- Two recording modes, QP (Quality Playback) mode or SP (Standard Playback) mode (E38 P. 26).
- Overwrite Recording and Insert Recording (partial insertion) available (E38 P.24, P.25).
- Supports USB 2.0. High-Speed, which enables high-speed data transmission from the recorder to your computer.
- Five folders and up to 200 files per folder, for a maximum of 1,000 recordings (E38 P.22).
- It has a built-in Variable Control Voice Actuator (VCVA) function (E38 P.28).
- Large LCD screen with backlight.
- Index mark function which is useful to search particular points in the dictation files (E38 P.38).
- DSS Player software included (E38 P.53).

Memory card

This recorder uses memory in the form of SD card memory.

Compatible cards

The recorder supports cards with memory capacity between 512 MB to 32 GB.

Settings and operating environment relating to the card

Check the latest operating information on the Olympus homepage (<http://www.olympus.com>) when using cards other than the included card. In addition, refer to the following pages as well when handling the card.

- Inserting and ejecting a SD card (P.19).
- Formatting the card [Format] (P.50).

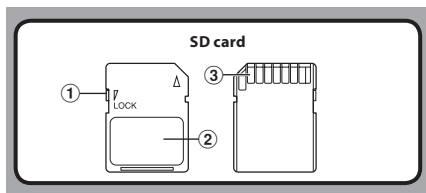

SD card

1 Card lock

SD card is equipped with a lock function. When the lock function is used, important data is protected by preventing it from being accidentally overwritten or erased. When the lock function is set [L] will appear on the display.

2 Index area

For writing down information identifying card or content.

3 Contact area

Comes into contact with the recorder's signal read contacts.

Check card information [Card Info.]

Information such as the memory capacity and remaining memory for installed cards can be displayed on the recorder (P.40).

Card Info.	
SD	
Remain	540MB
Capacity	2.0GB

BACK EXIT

Notes

- **When initializing (formatting) a card, confirm that no necessary data is stored on the memory card beforehand. Initialization completely erases the existing data on the card.**
- In some cases cards which have been formatted (initialized) by another device, such as a computer, cannot be recognized. Be sure to format them with this recorder before using.
- The card has a service life. When reaching the end of its life, writing or erasing data on the card will be disabled. In this case, replace the card.
- If you use a PC card adapter compatible with the card to save or delete some data on the card, the maximum recording time on the card may be decreased. To recover the original recording time, initialize/format the card in the recorder.
- Olympus will not be held liable for any data corruption or loss due to misuse of the media card.

Identification of parts

1

Identification of parts

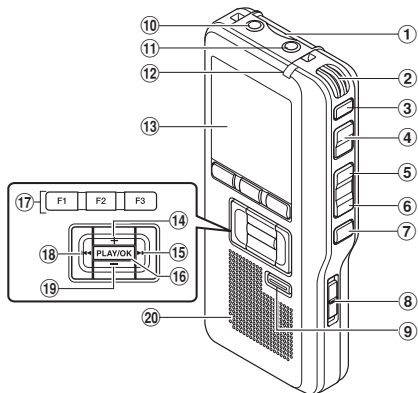

- ① SD card slot
- ② Built-in microphone
- ③ NEW button
- ④ REC button
- ⑤ REW button
- ⑥ FF button
- ⑦ STOP button
- ⑧ POWER/HOLD switch
- ⑨ ERASE button
- ⑩ EAR (Earphone) jack
- ⑪ MIC (Microphone) jack
- ⑫ Record indicator light
- ⑬ Display (LCD panel)

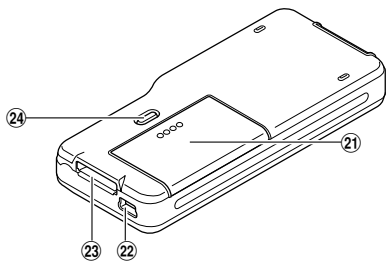

- ⑭ + (Volume) button
- ⑮ Fast Forward (▶▶) button
- ⑯ PLAY/OK button
- ⑰ Smart button (F1,F2,F3)
- ⑱ Rewind (◀◀) button
- ⑲ - (Volume) button
- ⑳ Built-in speaker
- ㉑ Battery cover
- ㉒ PC (USB) terminal
- ㉓ Cradle connector
- ㉔ Battery cover release button

Display status indicators (LCD panel)

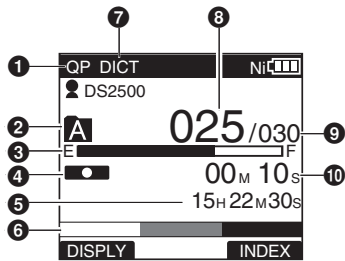

Display in the recording mode

- ① Record mode indicator
- ② Current folder
- ③ Memory remaining indicator (E/F bar)
- ④ Record indicator
- ⑤ Remaining recording time
- ⑥ Level meter indicator
- ⑦ Microphone sensitivity indicator
- ⑧ Current file number

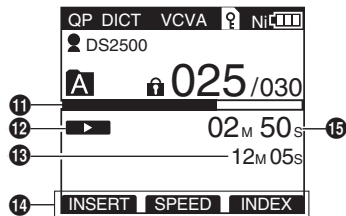

Display in the playback mode

- ⑨ Total number of files in the folder
- ⑩ Recording elapsed time
- ⑪ Playback position bar indicator
- ⑫ Play indicator
- ⑬ Total recording time of the selected file
- ⑭ Button guide display
- ⑮ Current playback time

- Ⓜ Author ID indicator
- Ⓝ Battery indicator
- Ⓥ VCVA (Variable Control Voice Actuator) indicator

- Ⓛ Card lock indicator
- Ⓛ Erase lock indicator

Power supply

Inserting batteries

This recorder can be used with either Ni-MH rechargeable batteries or AAA alkaline batteries.



- When charging with the recorder, be sure to use the supplied Ni-MH rechargeable batteries (BR404).
- The supplied rechargeable batteries are not fully charged. Before using the recorder or after long periods of disuse, it is recommended that you continuously charge them until full (see P.14, P.15).

- 1** Lightly press down on the battery cover release button, then open the battery cover.

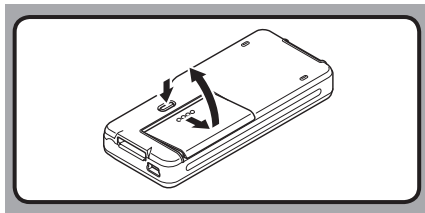

- 2** Insert batteries, observing the correct polarity as shown in the illustration below, then close the battery cover.

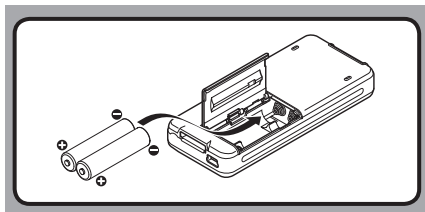

Cautions concerning the battery



Warning:



- Using batteries for which part or all of the external coating (insulating sheath) is peeling off or batteries which have ruptured may cause fluid leaks, overheating, and explosions. For this reason such batteries should absolutely not be used.
- Commercially available batteries for which part or all of the external coating (insulation sheath) has been peeled off should absolutely not be used.



Unusable batteries

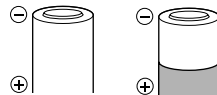

Batteries for which the entire external coating (insulating sheath) is peeled off (naked batteries), or those where it has partially been peeled off.



Notes

- Manganese batteries may not be used in this recorder.
- When changing batteries, AAA alkaline batteries or Olympus Ni-MH rechargeable batteries are recommended.
- **Be sure to turn OFF the recorder before replacing the batteries.** Removing the batteries while the recorder is in use may corrupt the card. If you are recording into a file and the batteries run out, you will lose your currently recorded file since the file header will not be written. It is crucial to replace the batteries when one hash mark is shown in the battery icon.
- Be sure to replace both batteries at the same time.
- **Never mix old and new batteries, or batteries of different types and/or brands.**
- If it takes longer than 15 minutes to replace the dead batteries or if you take the batteries in and out repeatedly at short intervals, you may have to redo the battery and time settings. In this case, the [Battery] screen will appear. For more details, see "Battery settings".
- Remove the batteries if you are not going to use the recorder for an extended period of time.
- When replacing rechargeable batteries, be sure to use Ni-MH rechargeable batteries (optional). The use of other manufacturers' products can damage the recorder and should be avoided.

Battery indicator

The battery indicator on the display changes as the batteries lose power.



- When this  indicator appears on the display, replace the batteries as soon as possible. When the batteries are too weak,  and [Battery Low] appears on the display and the recorder shuts down.

Battery settings

Select to match the battery you are using.

- 1 Replace the batteries and turn on the recorder (P.12).**
- 2 Press the + or – button to change the setting.**

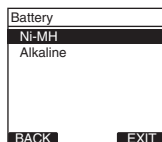

[Ni-MH] ():

Select when using the Olympus Ni-MH rechargeable batteries (BR404).

[Alkaline] ():

Select when using alkaline batteries.

- 3 Press the PLAY/OK button to complete the setting.**
 - If the "Hour" indicator flashes in the display, see "Setting time and date [Time & Date]" (P.20).

Note

- When playing a voice file, the recorder may be reset due to the reduction of the voltage output of the batteries depending on the volume level even if  is displayed in the battery indicator. In this case, lower the volume of the recorder.

Charging by connecting to a computer via USB

You can charge the batteries by connecting to a PC's USB port. When charging, be sure to correctly place the rechargeable batteries (supplied) into the recorder (☞ P.12).



Before connecting the USB cable, exit HOLD mode (☞ P.18).

Do not charge primary batteries such as alkaline or lithium batteries. It may cause battery leakage or heating, which may cause the recorder to malfunction.

1 Boot the PC.

2 Connect the USB cable to the USB port of the PC.

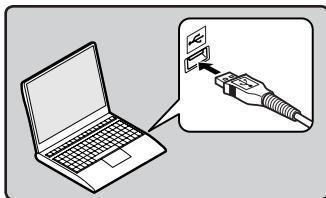

3 While the recorder is in stop mode or turned off, connect the USB cable to the connecting terminal on the bottom of the recorder.

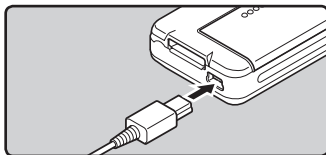

4 Press the PLAY/OK button to start charging.

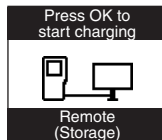

- While [Press OK to start charging] is flashing, press the PLAY/OK button.

5 Charging is completed when battery indication becomes to [B].

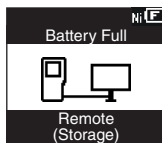

Charging time: approximately 3 hours *

- * It shows the approximate time when charging rechargeable batteries fully from no remaining power at the room temperature. The charging time will be changed depending on the remaining amount and the state of batteries.

Notes

- The recorder cannot be charged when the PC is not turned on. It may not also be charged when the PC is in standby, hibernate, or sleep mode.
- Do not charge the recorder with the USB hub connected.

Connecting the USB-type AC adapter (optional) to charge

It can be charged by connecting to the USB connecting AC adapter (A514) (optional).



- Before connecting the AC adapter, switch the USB connection setting to **[AC Adapter]** (☞ P.48).
- Before connecting the USB cable, exit **HOLD mode** (☞ P.18).

1 Plug the recorder's USB cable into the AC adapter.

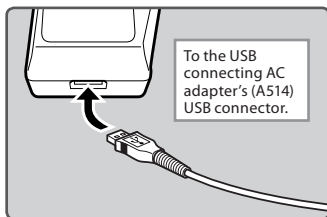

2 Plug the AC adapter into AC outlet.

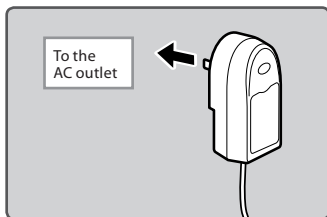

3 While the recorder is in stop mode or turned off, connect the USB cable to the connecting terminal on the bottom of the recorder.

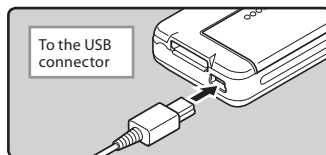

4 Press the PLAY/OK button to start charging.

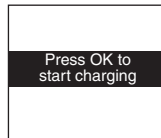

- While **[Press OK to start charging]** is flashing, press the **PLAY/OK** button.

5 Charging is completed when **[Battery Full]** is displayed.

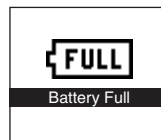

Notes

- Insert the supplied rechargeable battery and set **[Battery]** to **[Ni-MH]**. If **[Battery]** is set to **[Alkaline]**, you cannot recharge (☞ P.13).
- You cannot charge when **[☐]*1** or **[☐]*2** blinks. Charge the batteries at a temperature in the range of 5°C to 35°C (41°F to 95°F).
 - *1 **[☐]**: When the surrounding temperature is low.
 - *2 **[☐]**: When the surrounding temperature is high.
- When using time becomes notably short even after the batteries are fully charged, replace them with new ones.
- Be sure to push the USB connector all the way in. Otherwise, the recorder may not operate properly.
- Be sure to use the included dedicated USB cable. If any other company's cable is used, it may lead to malfunction of the recorder. Also, never use this dedicated cable with any other company's products.
- If selecting **[Composite]** in the USB connection settings:
 - Charge will not be possible if the recorder is operating. Charge will start 1 minute after the end of the operation.
 - Charge may not be possible depending on the application in use on the computer connected.
- In case you would like to charge using the **[Composite]** setting, select **[Optional]** in the USB connection settings, then connect the USB cable to the recorder. Selecting **[AC Adapter]** at the **[USB Connect]** display will enable you to charge (☞ P.48).

Cautions concerning the rechargeable batteries

Read the following descriptions carefully when you use the Ni-MH rechargeable batteries.

Discharging:

Rechargeable batteries self-discharge while not in use. Be sure to charge them regularly before use.

Operating temperature:

The rechargeable batteries are chemical products. The rechargeable batteries efficiency may fluctuate even when operating within the recommended temperature range. This is an inherent nature of such products.

Recommended temperature range:**When operating appliance:**

0°C - 42°C / 32°F - 107.6°F

Charging:

5°C - 35°C / 41°F - 95°F

Storage for a long period:

-20°C - 30°C / -4°F - 86°F

Using the rechargeable batteries outside the above temperature range may result in declining efficiency and shorter battery life. In order to prevent battery leakage or rust, remove the rechargeable batteries from the products when you will not be using them for a long time, and store them separately.

Notes

- This recorder is designed to fully charge batteries regardless of their energy level. However, for best results when charging newly purchased rechargeable batteries or batteries that have not been used for a long time (more than one month), it is recommended to fully charge the batteries then discharge repeatedly for 2 to 3 times.
- When disposing rechargeable batteries, always observe the local laws and regulations. Contact your local recycling center for proper disposal methods.
- If Ni-MH rechargeable batteries are not fully discharged, protect against short-circuiting (e.g. by taping the contacts) before disposing.

Turning on/off the power

When the recorder is not being used, turn the power off to reduce battery consumption to a minimum. Even if the power is turned off, existing data, mode settings, and clock settings will be maintained.

Turning on the power

While the recorder is turned off, slide the **POWER/HOLD** switch to the direction of the arrow.

- The display will turn on, and after [System Check] appears, the power will be turned on. The resume function will bring the recorder back to the stop position in memory before power was turned off.

Turning off the power

Slide the **POWER/HOLD** switch to the direction of the arrow, and hold it for **0.5 seconds or longer**.

- The display shuts off and the power will be turned off. The resume function remembers the stop position before the power is turned off.

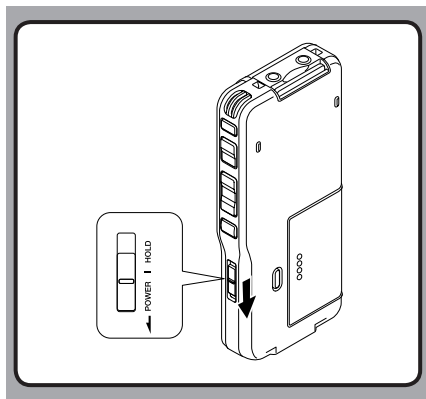

Power Save Mode (Power Save)

When the recorder is ON but not in use for 10 minutes, by default, it will switch to power save mode automatically. To reactivate the recorder again, operate any button or the slide switch.

Power Save Setting

You can set the time to enter Power Save mode from among [5 minutes], [10 minutes], [30 minutes], [1 hour], and [Off].

To exit power save, press any button.

The [Power Save] setting can be changed from the Menu. For more details, refer to "Menu list" (P.39) and "Learning to use the menu" (P.41).

Power Save
5 minutes
10 minutes
30 minutes
1 hour
Off
BACK EXIT

HOLD

If you bring the **POWER/HOLD** switch to the **HOLD** position, the current conditions will be preserved, and all buttons and switches will be disabled. This feature is useful when the recorder has to be carried in a bag or pocket.

Set the recorder to HOLD mode

1

HOLD

Slide the **POWER/HOLD** switch to the **HOLD** position.

- After **[Hold]** appears on the display, the recorder is set to HOLD mode.

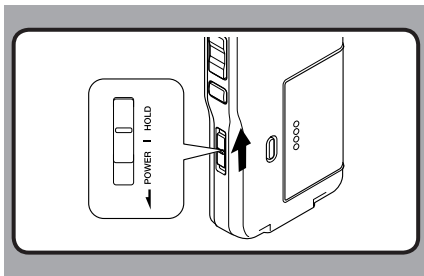

Exit HOLD mode

Slide the **POWER/HOLD** switch to the **(A)** position.

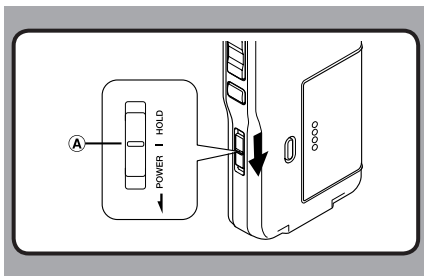

EN

Inserting and ejecting a SD card

Inserting a SD card

Insert the SD card fully into the card slot with the card facing the direction shown in the illustration below, until it clicks into place.

- When inserting SD card into the SD card slot, the recorder message **[Please Wait]** will flash on the LCD display for a few seconds while validating the SD card.
- Insert the card keeping it straight.

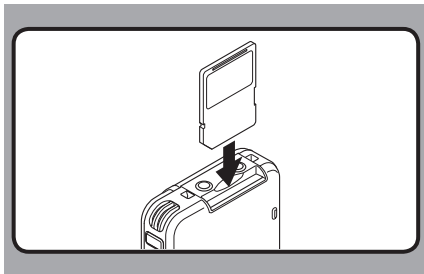

Ejecting a SD card

Push the SD card inward once to unlock it, and let it eject.

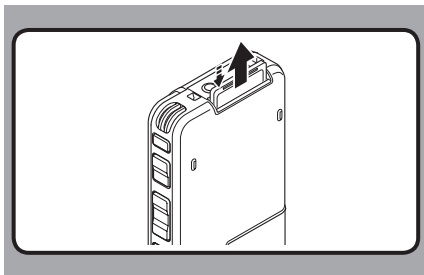

Notes

- **The card stops with a click when it is inserted all the way.**
- **Inserting the card the wrong way or at an angle could damage the contact area or cause the card to jam.**
- **If the card is not inserted all the way, data may not be written to the card.**
- **Hold the card straight and pull it out.**
- If an unformatted card is installed, the recorder will automatically display the menu format option (P.37).
- Never use any card in the recorder unless it has been formatted on this unit (P.50).
- Never remove the card while the recorder is in operation. This may damage the data.
- Releasing your finger quickly after pushing the card inward may cause it to eject forcefully out of the slot.

Setting time and date [Time & Date]

Setting the correct time and date on the recorder is very important since every file recorded on the recorder will have the time and date information as part of the file header. This will simplify the file management aspects later on.

1

Setting time and date

The hour indicator will flash automatically when you load batteries before using the recorder for the first time, or after the recorder hasn't been used for a long time.

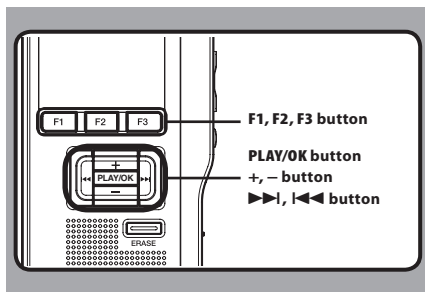

1 Press the ▶▶ or ◀◀ button to select the item to set.

- Select the item from the “hour”, “minute”, “year”, “month” and “day” with a flashing point.

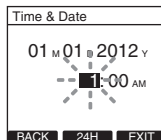

2 Press the + or - button to set.

- Follow the same steps by pressing the ▶▶ or ◀◀ button to select the next item, and press the + or - button to set.

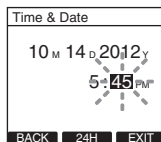

- You can select between 12 and 24 hour display by pressing the **F2** ([24H] or [12H])* button while setting the hour and minute.

Example: 5:45 P.M

5:45 PM (Initial setting) ↔ 17:45

- You can choose the order of the year, month, day by pressing the **F2**([M]/[D]/[Y]) or **[D]/[M]/[Y]** or **[Y]/[M]/[D]**)* button while setting them.

Example: October 14, 2012

10M 14D 2012Y
(Initial setting)

↓
14D 10M 2012Y

↓
2012Y 10M 14D

- * The display will vary depending on the status of the settings.

3 Press the **PLAY/OK** button to complete the setting.

- The clock will start from the set date and time. Press the **PLAY/OK** button according to the time signal.

Notes

- If you press the **STOP** button during the setup operation, the settings are cancelled, and the recorder returns to the previous screen.
- You can set the time and date from your PC using DSS Player software (☞ P.53).

Changing the time and date

When the recorder's **POWER/HOLD** switch is turned ON the **[Time & Date]** will be displayed for two seconds. If the time and date is not correct, set it using the procedure below.

1 Press the **+** or **-** button in the **[Device Menu]** screen, then select **[Time & Date]**.

- Refer to P.41 regarding each menu item settings.

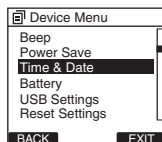

2 Press the **PLAY/OK** or **▶▶▶** button.

- The time and date screen appears. The hour indicator flashes, indicating the start of the time and date setup process. The following steps are the same as Step 1 through Step 3 of "**Setting time and date [Time & Date]**" (☞ P.20).

3 Press the **F3(EXIT)** or **◀◀◀** button to complete the setting.

Recording

The recorder has five folders, [A], [B], [C], [D], [E] and you can select a folder by pressing the **F1 (FOLDER)** button. These five folders can be selectively used to distinguish the kind of recording; for example, Folder [A] might be used to store private information, while Folder [B] might be dedicated to holding business information.

Up to 200 messages can be recorded per folder.

By default, the Recording Mode is [QP].

Record function

By default, the RECORD function is configured to record at the current position (overwrite).

However, that can be changed to any of the following settings:

- **Append:** Appends the recording to the end of the current file (☞ P.23).
- **Overwrite:** Overwrites the recording starting at the current position in the file (☞ P.24).
- **Insert:** Inserts the recording at the current position in the file (☞ P.25).

Recording related settings

Recording related settings can be configured to provide a suitable recording environment.

- Recording modes [**Rec Mode**] (☞ P.26).
- Microphone sensitivity [**Mic Sense**] (☞ P.27).
- Using the Variable Control Voice Actuator [**VCVA**] (☞ P.28).
- Recording monitor (☞ P.29).

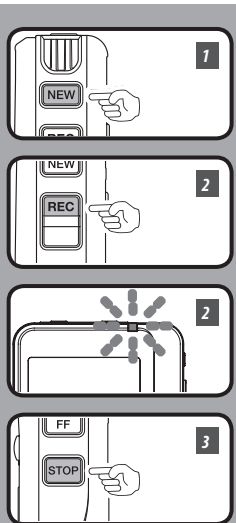

New recording

Create a new file to record in.

1 Press the NEW button to create a new file.

- a Selected Author ID
- b New file number
- c Remaining recording time

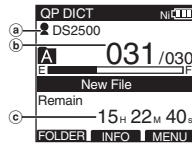

2 Press the REC button to start recording.

- The record indicator light glows orange and [RECORD INDICATOR] (Record indicator) appears on the display. Aim the microphone at the sound source. When you press the **F1 (DISPLY)** button during recording, you can change the LCD screen displays.

- d Record indicator

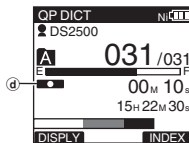

3 Press the STOP button to stop recording.

- If you want to append additional recordings to the same file, press the **REC** button again.

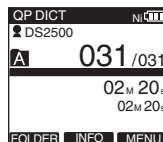

Notes

- A beep will sound when the remaining recording time reaches 60 seconds, 30 seconds, and 10 seconds while recording.
- When remaining recording time is less than 60 seconds, the record indicator light starts flashing in orange. When the recording time is decreasing to 30 or 10 seconds, the light flashes faster.
- **[Memory Full]** or **[Folder Full]** will be displayed when the memory or folder capacity is full.
 - Delete unnecessary files before recording any further (Ⓜ P.32) or transfer dictation files to your PC (Ⓜ P.53).

Overwrite recording

You can overwrite a previously recorded file from any point within the file. Note that the overwritten recordings will be erased.

1 Select and play the file you want to overwrite.

- Stop the playback at the point you want to start overwriting.

2 Press the REC button to start overwriting.

- The record indicator light glows orange and  (Record indicator) appears on the display.

- Ⓐ Recording elapsed time
- Ⓑ Total recording time of the selected file

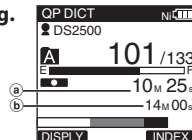

3 Press the STOP button to stop overwriting.

Note

- You cannot select a different recording mode ([QP], [SP]) than that of the original file before overwrite recording.

Insert recording

Additional recording can be inserted into previously recorded file.

1 Select and play the file you want to insert an additional recording into.

2 While playing the file, press the F1 (INSERT) button to insert an additional recording.

- [Insert Rec?] appears on the display.

3 Press the REC button to start inserting an additional recording.

- The record indicator light glows orange and [RECORD] (Record indicator) appears on the display. [Insert Rec] and the remaining recording time will alternate on the display.

4 Press the STOP button to stop inserting the additional recording.

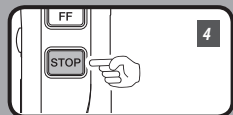
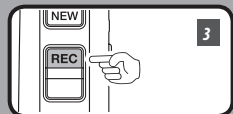
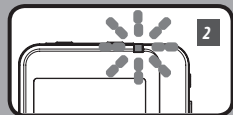
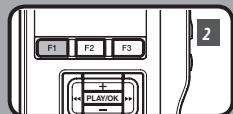
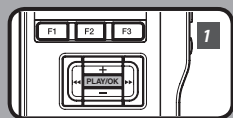
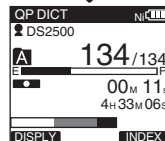
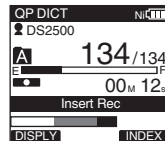
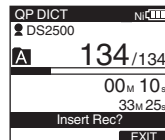

Notes

- The recording time and date of the file is updated to the time and date of the inserted recording.
- You cannot select a different recording mode ([QP], [SP]) than that of the original file before inserting.

Recording modes [Rec Mode]

The recording mode can choose between [QP] (Quality Playback) and [SP] (Standard Playback).

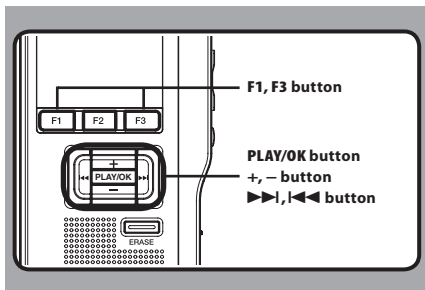

2

Recording modes

1 Select [Rec Mode] at the [Record Menu] screen, then press the PLAY/OK or >>>| button.

- Refer to P.41 regarding each menu item settings.

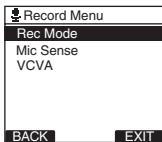

2 Press the + or - button to select [QP] or [SP].

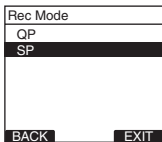

3 Press the PLAY/OK button to complete the setting.

- [Setting fixed] will light up on the display, and it will return to the [Record Menu] screen.
- If you press the <<< or F1 (BACK) button the setting will be cancelled and it will return to the [Record Menu] screen.
- Pressing the F3 (EXIT) button will cancel the contents being set and take you out of the MENU.

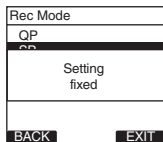

4 Press the F3 (EXIT) or <<< button to close the menu screen.

- Set recording mode is displayed when creating the new file and during recording.
- The recording mode of file recording is displayed during playback and in stop mode.

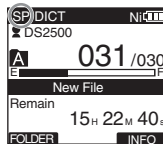

Note

- Choose [QP] mode for recording meetings or lectures with crisp clarity.

Microphone sensitivity [Mic Sense]

You can switch between two microphone sensitivities to meet recording needs: [Dictation] for oral dictation and [Conference] which is suited for situations like meetings and conferences with a small number of people.

The setting status will appear on the display as [CONF] or [DICT].

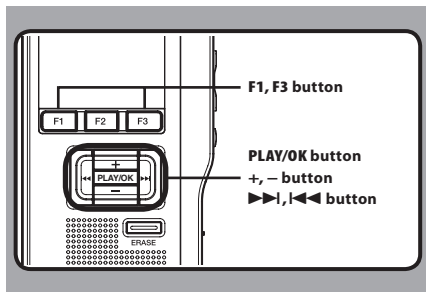

1 Select [Mic Sense] at the [Record Menu] screen, then press the PLAY/OK or ▶▶| button.

- Refer to P.41 regarding each menu item settings.

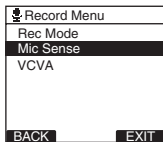

2 Press the + or - button to select [Conference] or [Dictation].

[Conference]: High-sensitivity mode that records sounds in all directions.

[Dictation]: Low-sensitivity mode suited for dictation.

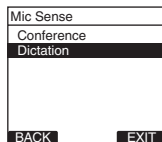

3 Press the PLAY/OK button to complete the setting.

- [Setting fixed] will light up on the display, and it will return to the [Record Menu] screen.
- If you press the ◀◀ or F1 (BACK) button the setting will be cancelled and it will return to the [Record Menu] screen.
- Pressing the F3 (EXIT) button will cancel the contents being set and take you out of the MENU.

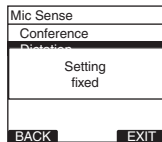

4 Press the F3 (EXIT) or ◀◀ button to close the menu screen.



Using the Variable Control Voice Actuator [VCVA]

The Variable Control Voice Actuator (VCVA) is a function that starts recording automatically when the microphone senses that sounds have reached a preset threshold volume level, and automatically pauses when the volume drops below the threshold. The VCVA feature allows you to conserve memory by automatically stopping recording in instances like long silent periods during meetings. When this is enabled, [VCVA] will appear on the display.

2

Using the Variable Control Voice Actuator

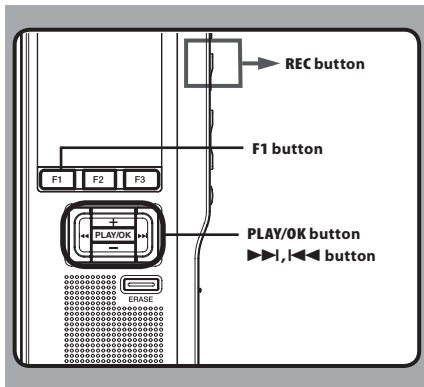

1 Set the VCVA in the menu to [0n].

- Refer to P.41 regarding each menu item settings.

2 Press the REC button to start recording.

- When the sound volume is lower than the preset actuation sound level, recording automatically stops after 1 second approximately, and "Stand by" flashes on the display. The record indicator light glows orange and [RECORD] (Record indicator) appears when recording starts and flashes when recording pauses.

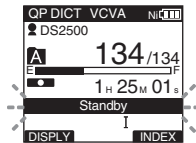

Adjust the start/stop actuation level:

While the recorder is in recording mode, press the **▶▶** or **◀◀** button to adjust the actuation level.

- The VCVA level can be set to any of 15 different values. The higher the value is, the more sensitive the recorder can react to sounds. At the highest value, even the faintest sound will activate recording.
- The VCVA actuation level can be adjusted according to the ambient (background) noise.

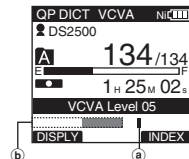

- (a) Start level (Varies according to the sound volume being recorded)
- (b) Level meter indicator (moves to the left/right according to the set level)

Notes

- The start/stop actuation level also varies depending on the selected microphone sensitivity mode (refer P.27).
- To ensure successful recordings, prior testing and adjustment of the start/stop actuation level is recommended.

EN

28

Recording monitor

It is possible to monitor your recording by listening to the recording while recording is in progress. Insert the earphone plug into the earphone jack and use the + or – button to control the volume level.

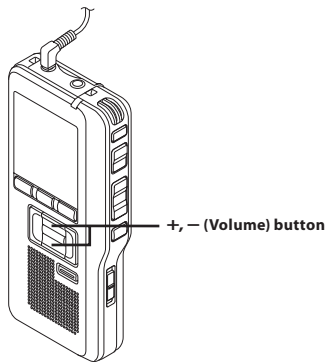

Note

- Insert the plugs in to the end as shown in the illustration when inserting the earphone or external microphone.

You can start playing a file at any point.

1 Select the file, then press the **PLAY/OK** button to start playback.

- The  (Play indicator) appears on the display.

Ⓐ Play indicator

2 Press the **+ or –** button to adjust the volume.

- The display shows the volume level. You can choose between **[00]** to **[30]**.

Ⓑ Volume level

3 Press the **STOP** button at any point you want to stop the playback.

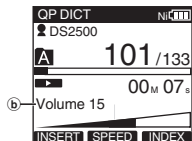
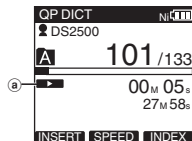

Playback functions	Operation	How to cancel
Fast Forward (FF)	Press the ▶▶ or FF button once while stopped.	Press the PLAY/OK or STOP button.
Rewind (REW)	Press the ◀◀ or REW button once while stopped.	Press the PLAY/OK or STOP button.
Cue (CUE)	Press and hold the ▶▶ or FF button while stopped or playing a file.	Release the button.
Review (REV)	Press and hold the ◀◀ or REW button while stopped or playing a file.	Release the button.
Playback Speed	<p>Press the F2 (SPEED) button during playback.</p> <ul style="list-style-type: none"> Every time the F2 (SPEED) button is pressed, the playback speed will switch. <p>Play (playback): Playback at normal speed.</p> <p>Slow Play (slow playback): Playback speed slows down (-50%), and "Slow play" will turn on.</p> <p>Fast Play (fast playback): Playback speed becomes faster (+50%), and "Fast play" will turn on.</p>	_____

Notes

- If you press the **▶▶** or **FF** button once while fast-forwarding or twice while stopped, the recorder will stop at the end of the file (F.Skip).
- If you press the **◀◀** or **REW** button once while rewinding or twice while stopped, the recorder will stop at the beginning of the file (B.Skip). If the **◀◀** or **REW** button is pressed within 2 seconds, the recorder skips to the beginning of the previous file.

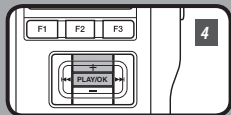
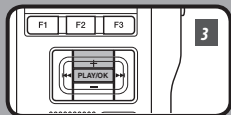
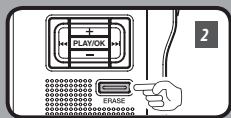

Erasing a file

Erasing or deleting a file from any of the folder on the recorder is a very simple process.

- 1 Select the file you want to erase.
- 2 Press the **ERASE** button.
- 3 Press the **+** button to select **[File Erase]**, then press the **PLAY/OK** button.
- 4 Press the **+** button to select **[Start]**, then press the **PLAY/OK** button.
 - The display changes to **[Erase !]** and erasing will start.

[Erase Done] is displayed when the file is erased. File numbers will be reassigned automatically.

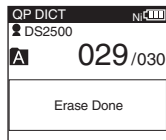
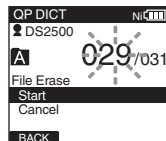
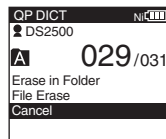

Notes

- An erased file cannot be restored.
- Files cannot be erased in the following cases.
 - File being set **[Lock]** (P.42).
 - Files stored on a locked SD card (P.9).

Erasing all files in a folder

All files in a folder can be erased simultaneously.

- 1 Select the file you want to erase.
- 2 Press the ERASE button.
- 3 Press the + button to select [Erase in Folder], then press the PLAY/OK button.
- 4 Press the + button to select [Start], then press the PLAY/OK button.
 - The display changes to [Erase !] and erasing will start.

[Erase Done] is displayed when the files are erased. Any locked files in the folder will be reassigned new file numbers in ascending order.

Notes

- The erasing process may take up to 10 seconds. Do not interrupt this process or data may be damaged.
- Files cannot be erased in the following cases.
 - File being set [Lock] (P.42).
 - Files stored on a locked SD card (P.9).

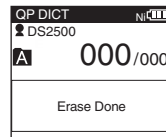
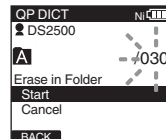
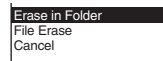
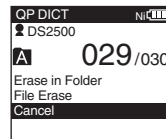
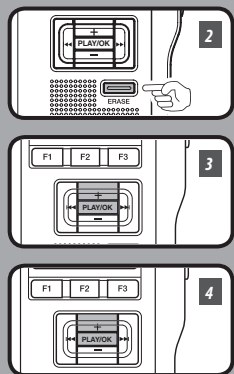

Partially erasing a file

You can erase a selected file in part.

1 Playback the file you would like to partially erase.

2 Press the ERASE button at the point to start erasing.

- While playback continues, [Erase start] will appear on the display.
- If you press the **F2** (▶) button, playback will skip (F.Skip) to the end of the file and then stop. That will be set automatically as the ending point of the partial erase.
- If you press the **F1** (◀) button, playback will skip back (B. Skip) and restart from the partial erase starting point.
Playback will continue until the end of the file or until the partial erase ending point is confirmed.

3 Press the ERASE button at the point to end erasing.

- The erase starting point (time) set in step 2 and the ending point (time) set in this step will alternate on the display for 8 seconds.

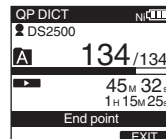
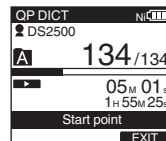
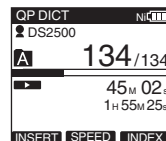

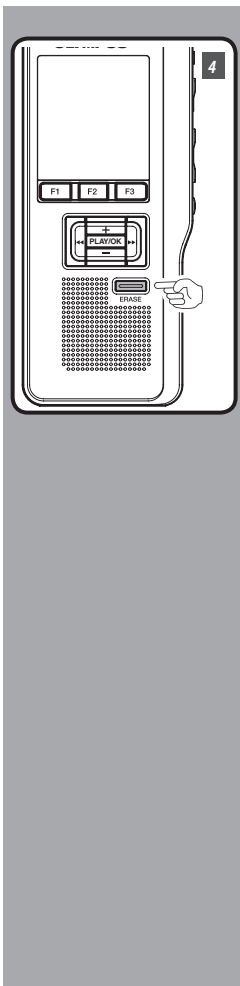

4 Press the **ERASE** button to confirm erase.

- The display changes to [**Partial erasing !**] and erasing will start.

When [**Partial erase completed.**] appears on the display, partial erase is complete.

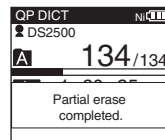
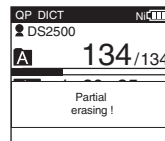

Notes

- If the **ERASE** button is not pressed within 8 seconds after the [**Start point**] and [**End point**] are alternately displayed, the recorder will revert to stop status.
- An erased file cannot be restored.
- Files cannot be partially erased in the following cases.
 - File being set [**Lock**] (P.42).
 - The SD card lock is turned on (P.9).

Advanced operations

Selecting folders and files

3

Selecting folders and files

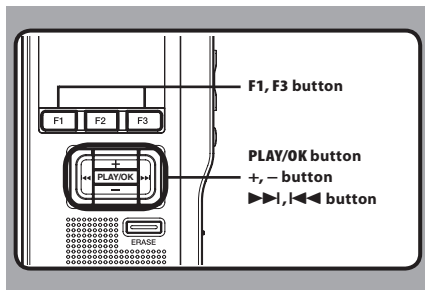

Changing folders

- 1 While the recorder is stopped, press the **F1 (FOLDER)** button.

- The folder list screen will be displayed.

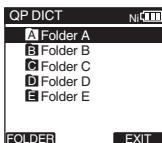

- 2 Press the **+** or **-** button to select the folder, then press the **PLAY/OK** button.

- This will change the folder.
- You can switch folders by pressing the **F1 (FOLDER)** button.

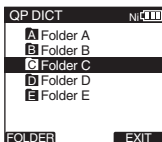

Changing file

- 1 While the file is being displayed, press the **▶▶** or **◀◀** button.

- This will change and display the file number order for files within the folder.

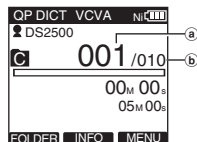

- a Current file number
- b Total number of recorded files in the folder

EN

36

Displaying file information [Information]

The recorder can display a variety of information related to the current file.

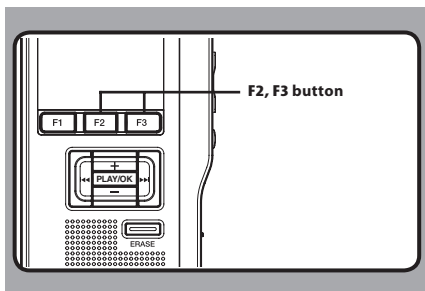

The displayed information

The following information will be displayed.

[File Name]:

File name.

[Rec Time]:

Time and date the file was recorded.

[Author ID]:

Display the Author ID of file.

Note

- When the file that Work Type or the Option Item is set is transferred from PC to this unit, the information will be displayed on the File Information.

1 Select the file containing the information to display.

- Refer to P.36 regarding file selection.



2 Press the F2 (INFO) button.

- The file information is displayed.
- You can display the file information by pressing the **F3 (MENU)** button and selecting **[Information]** from **[File Menu]**.

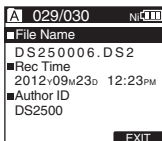

Index marks

Index marks can be placed in a file during recording or playback. Index marks are used to provide a quick and easy way to identify important or significant parts within the file.

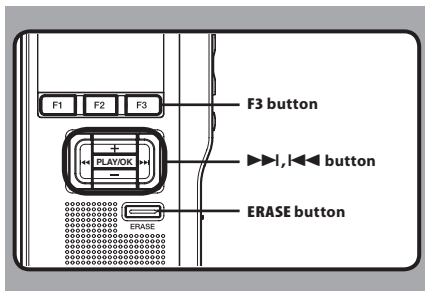

Setting an index mark

1 While the recorder is recording or in playback mode, press the **F3 (INDEX)** button to set an index mark.

- An index number appears on the display.

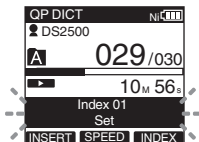

Locating an index mark

2 While playing back a file, press and hold the **▶▶| or |◀◀** button.

- The recorder stops for 1 second when it reaches the index mark.

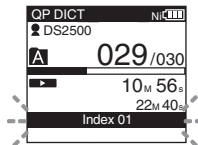

Clearing an index mark

3 Locate the index mark you want to clear.

4 While the index number appears for approximately 2 seconds on the display, press the **ERASE** button.

- The index mark is erased.

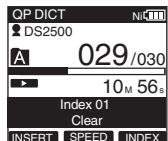





Notes

- Up to 32 index marks can be set with in a file.
- When a file is locked or set to read-only, or when the SD card lock is enabled index mark cannot be erased. Clear the settings before erasing.

Menu list

- Menu setting (While the recorder is stopped, press the **F3 (MENU)** button)

Main menu	Second layer	Setting	Ref.page
 File Menu	<div style="border: 1px dashed gray; padding: 5px;"> <div style="border: 1px solid gray; padding: 5px; margin-bottom: 5px;">Lock</div> <div style="border: 1px solid gray; padding: 5px;">Information</div> </div>	[Off], [On]	P.42
		The file information is displayed.	P.37
 Record Menu	<div style="border: 1px dashed gray; padding: 5px;"> <div style="border: 1px solid gray; padding: 5px; margin-bottom: 5px;">Rec Mode</div> <div style="border: 1px solid gray; padding: 5px; margin-bottom: 5px;">Mic Sense</div> <div style="border: 1px solid gray; padding: 5px;">VCVA</div> </div>	[QP], [SP]	P.26
		[Dictation], [Confeuy.n.rence]	P.27
		[Off], [On]	P.28
 Display Menu	<div style="border: 1px dashed gray; padding: 5px;"> <div style="border: 1px solid gray; padding: 5px; margin-bottom: 5px;">Backlight</div> <div style="border: 1px solid gray; padding: 5px; margin-bottom: 5px;">Contrast</div> <div style="border: 1px solid gray; padding: 5px; margin-bottom: 5px;">LED</div> <div style="border: 1px solid gray; padding: 5px;">Languages</div> </div>	[On], [Off]	P.43
		Program contrast level [01]~[12] (Default is [06]).	P.44
		[On], [Off]	P.45
		[English], [Deutsch], [Français], [Español], [Italiano], [Русском]	P.46
Device Menu (To the next page)			

Main menu	Second layer	Setting	Ref.page
 Devices Menu	Beep	[On], [Off]	P.47
	Power Save	[5 minutes], [10 minutes], [30 minutes], [1hour], [Off].	P.17
	Time & Date	In order of hour, minute, year, month and day.	P.20
	Battery	[Ni-MH], [Alkaline]	P.13
	USB Settings	[USB Connect]: [PC], [AC Adapter], [Optional] [USB Class]: [Composite], [Storage]	P.48
	Reset Settings	Returns the menu settings to their initial state.	P.51
	Format	Initializes the card.	P.50
	Card Info.	[Remain], [Capacity]	P.9
	System Info.	[Model Name], [Version], [Serial]	P.52
File Menu (To the page 39)			

Notes

- The selectable language varies depending on the countries where the product was purchased.
- Items appear in bold letters in the “**Setting**” column to indicate that they are the initial settings.

Learning to use the menu

To navigate through the different options in the menu, use the menu list flow chart (P.39, P.40) and the following steps to modify or change any settings.

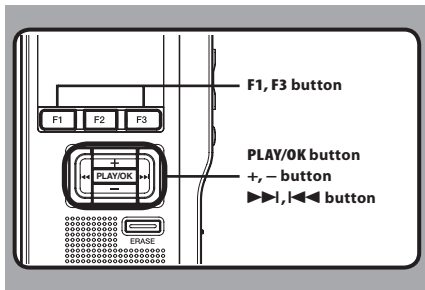

1 Press the F3 (MENU) button.

- The [Main Menu] screen will appear on the display.

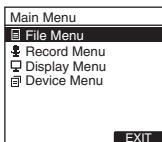

2 Press the + or - button to move to [Main Menu] item to be set.

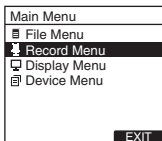

3 Press the PLAY/OK or ▶▶ button.

- Move to the setting of the selected menu items.

4 Press the + or - button to move to the menu item to be set.

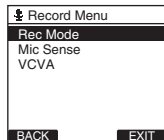

5 Press the PLAY/OK or ▶▶ button.

- Move to the setting of the selected item.

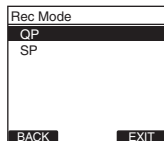

6 Press the + or - button to change the setting.

7 Press the PLAY/OK button to complete the setting.

- If you press the ◀◀ or F1 (BACK) button, the setting will be cancelled and it will return to the menu.
- Pressing the F3 (EXIT) button will cancel the contents being set and take you out of the MENU.

8 Press the F3 (EXIT) or ◀◀ button to close the menu screen.

Locking files [Lock]

When a file is set to [Lock],  will appear on the display, allowing you to prevent important files from accidental erase. Moreover, the file will not be erased even when all files within a folder are erased.

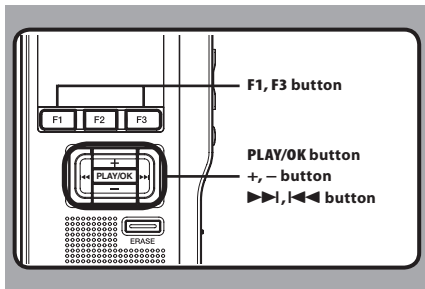

- 1 Select the file you want to lock.
- 2 Select [Lock] at the [File Menu] screen, then press the PLAY/OK or ▶▶|◀◀ button.

- Refer to P.41 regarding each menu item settings.

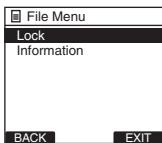

- 3 Press the + or - button to select [On] or [Off].

[On]: Locks the file and prevents it from being erased.  appears on the display.

[Off]: Unlocks the file and allows it to be erased.

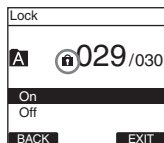

- 4 Press the PLAY/OK button to complete the setting.

- [File Lock On] or [File Lock Off] will light up on the display, and it will return to the [File Menu] screen.
- If you press the ◀◀ or F1 (BACK) button the setting will be cancelled and it will return to the [File Menu].
- Pressing the F3 (EXIT) button will cancel the contents being set and take you out of the MENU.

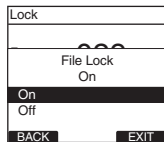

- 5 Press the F3 (EXIT) or ◀◀ button to close the menu screen.



Backlight [Backlight]

When the display backlight is set to [On], the backlight will light up for about 10 seconds when a button is pressed. This is useful in that it allows you to check the display even in dark locations.

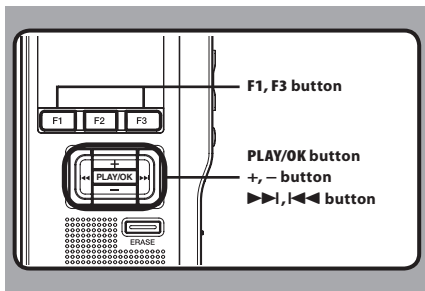

1 Select [Backlight] at the [Display Menu] screen, then press the PLAY/OK or ▶▶| button.

- Refer to P.41 regarding each menu item settings.

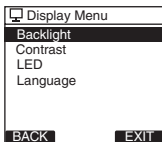

2 Press the + or - button to select [On] or [Off].

[On]: Backlight is enabled.
[Off]: Backlight is disabled.

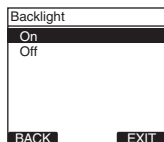

3 Press the PLAY/OK button to complete the setting.

- [Setting fixed] will light up on the display, and it will return to the [Display Menu] screen.
- If you press the ◀◀ or F1 (BACK) button the setting will be cancelled and it will return to the [Display Menu] screen.
- Pressing the F3 (EXIT) button will cancel the contents being set and take you out of the MENU.

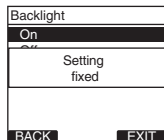

4 Press the F3 (EXIT) or ◀◀ button to close the menu screen.

3

Backlight

LCD contrast adjustment [Contrast]

Display contrast can be adjusted from level [01] to [12].

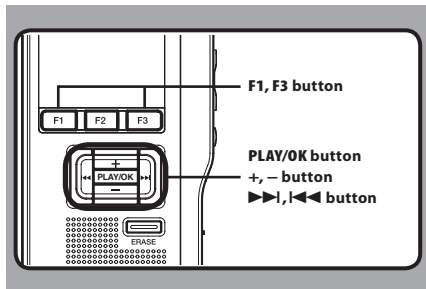

3

LCD contrast adjustment

- 1 Select [Contrast] at the [Display Menu] screen, then press the PLAY/OK or >>>| button.

- Refer to P.41 regarding each menu item settings.

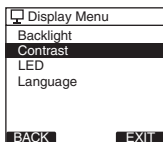

- 2 Press the + or - button to set the contrast level.

- You can adjust the LCD display contrast level from [01] to [12].

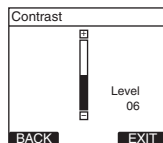

- 3 Press the PLAY/OK button to complete the setting.

- The set contrast level lights up and will return to the [Display Menu] screen.
- If you press the <<<| or F1 (BACK) button the setting will be cancelled and it will return to the [Display Menu] screen.
- Pressing the F3 (EXIT) button will cancel the contents being set and take you out of the MENU.

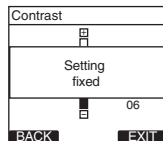

- 4 Press the F3 (EXIT) or <<<| button to close the menu screen.

LED [LED]

You can set it so the Record indicator light does not turn on.

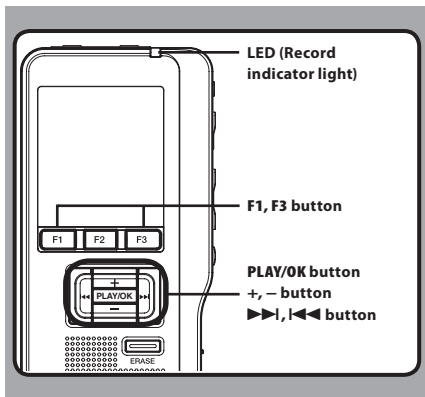

1 Select [LED] at the [Display Menu] screen, then press the PLAY/OK or ▶▶| button.

- Refer to P.41 regarding each menu item settings.

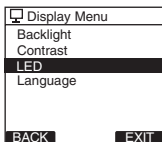

2 Press the + or - button to select [On] or [Off].

[On]: LED light will be set.

[Off]: LED light will be cancelled.

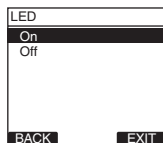

3 Press the PLAY/OK button to complete the setting.

- [Setting fixed] will light up on the display, and it will return to the [Display Menu] screen.
- If you press the ◀◀| or F1 (BACK) button the setting will be cancelled and it will return to the [Display Menu] screen.
- Pressing the F3 (EXIT) button will cancel the contents being set and take you out of the MENU.

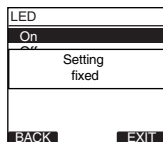

4 Press the F3 (EXIT) or ◀◀| button to close the menu screen.

3

LED

Language [Language]

You can select the display language for this recorder. The selectable language varies depending on the countries where the product was purchased.

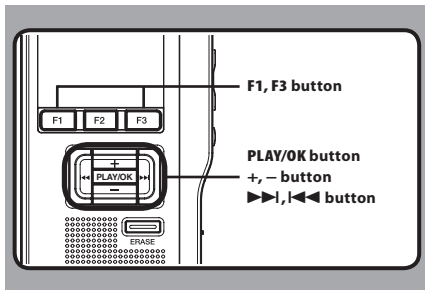

1 Select [Language] at the [Display Menu] screen, then press the PLAY/OK or >>>| button.

- Refer to P.41 regarding each menu item settings.

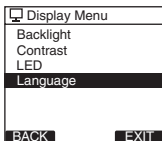

2 Press the + or - button to set the language.

- [English]: Displays in English.
- [Deutsch]: Displays in German.
- [Français]: Displays in French.
- [Español]: Displays in Spanish.
- [Italiano]: Displays in Italian.
- [Русский]: Displays in Russian.

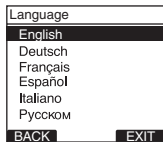

3 Press the PLAY/OK button to complete the setting.

- The displayed language is changed and will return to the [Display Menu] screen.
- If you press the <<< or F1 (BACK) button the setting will be cancelled and it will return to the [Display Menu] screen.
- Pressing the F3 (EXIT) button will cancel the contents being set and take you out of the MENU.

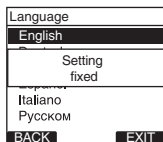

4 Press the F3 (EXIT) or <<< button to close the menu screen.

Note

- The selectable language varies depending on the countries where the product was purchased.

System sounds [Beep]

When this is set to **[On]**, the recorder beeps to alert you to button operations or warn you of errors.

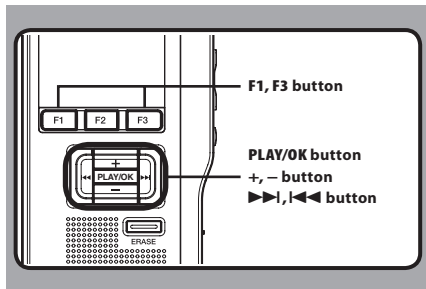

1 Select [Beep] at the [Device Menu] screen, then press the PLAY/OK or ▶▶ button.

- Refer to P.41 regarding each menu item settings.

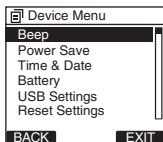

2 Press the + or - button to select [On] or [Off].

[On]: System sounds are enabled.
[Off]: System sounds are disabled.

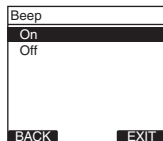

3 Press the PLAY/OK button to complete the setting.

- **[Setting fixed]** will light up on the display, and it will return to the **[Device Menu]** screen.
- If you press the ◀◀ or F1 (**BACK**) button the setting will be cancelled and it will return to the **[Display Menu]** screen.
- Pressing the F3 (**EXIT**) button will cancel the contents being set and take you out of the MENU.

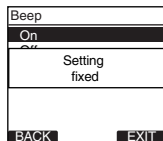

4 Press the F3 (EXIT) or ◀◀ button to close the menu screen.

Changing the USB class [USB Settings]

Besides setting to **[PC]** (Connect to PC to transfer files) or **[AC Adapter]** (Connect to AC adapter to recharge the battery), you can switch the USB class according to your usage.

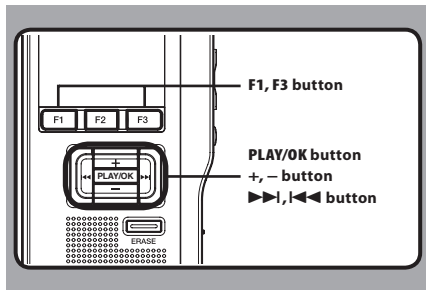

1 Select **[USB Settings]** at the **[Device Menu]** screen, then press the **PLAY/OK** or **▶▶|,|◀◀** button.

- Refer to P.41 regarding each menu item settings.

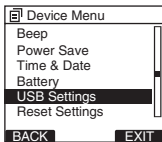

2 Press the **+** or **-** button to select **[USB Connect]** or **[USB Class]**.

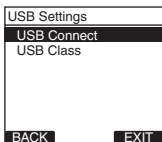

[USB Connect]: Setting for connecting to the PC.
[USB Class]: Setting for USB class.

3 Press the **PLAY/OK** button.

- If you select **[USB Class]**, proceed to the operation of Step 6.

When **[USB Connect]** is selected:

4 Press the **+** or **-** button to change the setting.

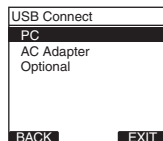

[PC]: Setting for when the recorder is connected to the PC and used as a storage device or composite device. Connected as storage or composite.

[AC Adapter]: Setting for when the recorder is connected to the PC for charging or to the AC Adapter (A514) (optional).

[Optional]: Setting to confirm the connection method each time a USB connection is made.

5 Press the **PLAY/OK** button to complete the setting.

- If you select **[USB Connect]**, proceed to the operation of Step 8.

When [USB Class] is selected:

- 6** Press the + or – button to change the setting.

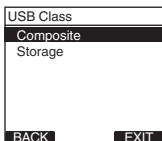

[**Composite**]: Setting when connected to the PC and used as an external memory device, USB speaker or microphone.

[**Storage**]: Recognized as an external memory device from the PC.

- 7** Press the **PLAY/OK** button to complete the setting.
- 8** Press the **F3 (EXIT)** or **◀◀** button to close the menu screen.

Notes

- When you first connect the recorder to your PC as an external storage device, the driver for the recorder will be automatically installed in your PC.
- The PC cannot recognize when the recorder is connected to the PC when setting for the [**USB Connect**] is set to [**AC Adapter**].

Formatting the card [Format]

Cards that have been used in non-Olympus devices, or cards that are not recognized by the recorder, must be formatted before they can be used with the recorder.

To familiarize yourself with the formatting process, read the steps below.

In terms of formatting, only selected cards can be formatted, the recorder's menu settings cannot be initialized. The initialization of menu items should be set up through DSS Player or the recorder's [Reset Settings].

3

Formatting the card

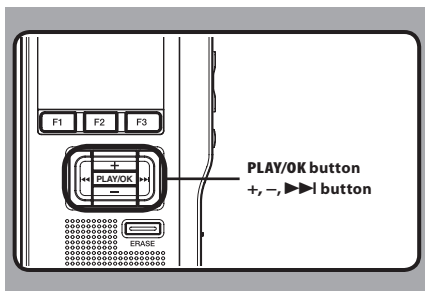

1 Select [Device Menu] at the [Format] screen, then press the PLAY/OK or >>> button.

- Refer to P.41 regarding each menu item settings.

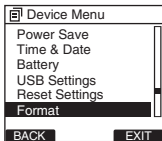

2 Press the + or - button to select [Start] option.

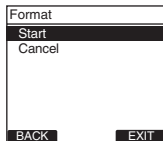

3 Press the PLAY/OK button to confirm [Start] selection.

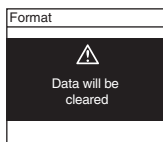

4 Press the + or - button again to select [Start] option.

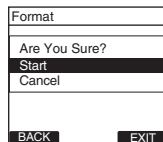

5 Press the PLAY/OK button again to initiate the formatting process.

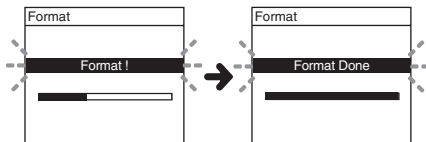

- [Format Done] displays when formatting ends.

EN

50

Initializing the recorder's menu settings

[Reset Settings]

To return the recorder's menu settings to their original status from the time of purchase (initial settings), perform the setting from **[Reset Settings]** in the **[Device Menu]**, or perform the same operation by using DSS Player.

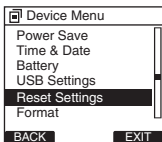

Notes

- The time required to format cards differs depending on the capacity of cards. Do not interrupt the formatting process by the following operations. Doing so will damage the data or card.
 - Remove the card.
 - Remove the batteries.
- When the card is formatted, all the stored data, including locked files, are erased.
- If an unformatted card is inserted, the recorder automatically displays the format option in the menu.
- SD cards for which the SD card lock is enabled cannot be initialized.
- Formatting on the recorder will be quick format. If you format the card, information of file management is refreshed and the data inside the card is not deleted completely. When handing over and disposing the card, be careful about the data leakage from the card. We recommend the card to be destroyed when you dispose the card.

Check system information [System info.]

System information about the recorder like its [Model Name], [Version] and [Serial] can be displayed.

In this recorder, you can check the card Information (P.9) and file Information (P.37).

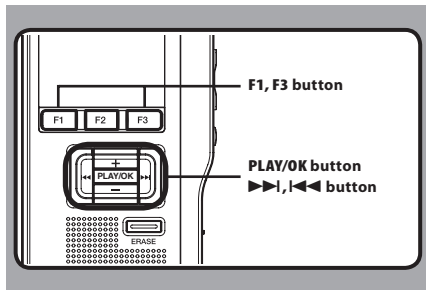

1 Select [System info.] at the [Device Menu] screen, then press the **PLAY/OK** or **▶▶|** button.

- [Model Name] [Version] [Serial] will appear.
- Refer to P.41 regarding each menu item settings.

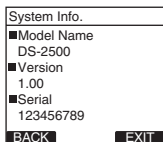

2 Press the **PLAY/OK**, **|◀◀** or **F1 (BACK)** button.

3 Press the **F3(EXIT)** or **|◀◀** button to close the menu screen.

DSS Player Software

The DSS Player is a fully featured software tool that provides a simple to use but sophisticated method of managing your recordings. Some of the features of the DSS Player are:

- Automatic startup of the application by connecting the device.
- Automatic download of Dictation by connecting the device.
- Voice recorder's menu setting.
- Direct recording and editing of existing Dictation through Voice recorder's button.

Make sure that your computer meets the minimum requirements listed below.

Minimum requirement

Windows

Operating System:

- Microsoft® Windows® XP:
 - Professional / Home Edition SP3 x86
 - Professional / Home Edition SP2 x64
- Microsoft® Windows Vista®:
 - Ultimate / Enterprise / Business / Home Premium / Home Basic SP2 (both x86/64)
- Microsoft® Windows 7®:
 - Ultimate / Enterprise / Professional / Home Premium (both x86/64)
 - Ultimate / Enterprise / Professional / Home Premium SP1 (both x86/64)

CPU:

- Microsoft® Windows® XP / Vista / 7: 1 GHz or higher

RAM:

- Microsoft® Windows® XP:
 - 256 MB or more
- Microsoft® Windows Vista®:
 - 1 GB or more
- Microsoft® Windows 7®:
 - 1 GB or more (32 bit) / 2 GB or more (64 bit)

Hard drive space:

- 2 GB or more

Browser:

- Microsoft Internet Explorer 6.0 or later

Drive:

- CD-ROM, CD-R, CD-RW, DVD-ROM drive

Display:

- 800 x 600 pixels or more, 65,536 colors or more (16,770,000 colors or more is recommended)

USB port:

- One or more free ports

Others:

- With the Dictation Module, Transcription Module:
 - A Microsoft WDM- or MME-compliant and Windows-compatible sound device

Macintosh

Operating System:

- Mac OS X 10.4.11 - 10.7

CPU:

- PowerPC® G3 500 MHz or more,
or Intel Core Solo/Duo 1.5 GHz or more

RAM:

- 256 MB or more (512 MB or more is recommended)

Hard drive space:

- 200 MB or more

Drive:

- CD-ROM, CD-R, CD-RW, DVD-ROM drive

Browser:

- Macintosh Safari 3.0.4 or later,
Mozilla Firefox 3.6.20 or later

Display:

- 1024 x 768 pixels or more, 32,000 colors or more

USB port:

- One or more free ports

Others:

- Audio device

Notes

- Even if the above conditions are satisfied, self-modified computers, self-upgraded OS or multiple OS environments are not supported.
- Macintosh version does not support voice recognition software.
- For information on the latest OS upgrades compatibility, visit the Olympus Web page at <http://www.olympus-global.com/en/global/>.

Installing software

Be sure to confirm the following before installation:

- Exit all running applications.
- Eject the floppy disk if you are using one.
- If you are running Windows XP/Vista/7 or Mac OS X on the network, you need to log on as an Administrator.

Windows

For the Windows version, there is an installation method for individuals and one for administrators to install on multiple client PCs.

An explanation of the installation method for individuals installing the software on a single PC will be provided here.

1 Insert Olympus DSS Player CD into the CD-ROM drive.

- The installation program will start automatically.
If the installation program does not start automatically, browse your CD-ROM drive and execute [**launcher.exe**].

2 The launcher will startup.

- Select the language you would like to install from the upper-left pull-down menu and click [**DSS Player Standard Installation**].

3 The Install Wizard will begin.

- Once you have consented to the licensing agreement, enter your name, company name, and license ID number (serial number).
The license ID number is printed on the license ID card included inside the recorder package.

4 Proceed with the installation according to the instructions on the screen.

Macintosh

1 Insert Olympus DSS Player CD into the CD-ROM drive.

2 Double-click the CD icon.

3 Double-click the setup icon.

- The Install Wizard will begin.
Once you have consented to the licensing agreement, follow the instructions on the screen to complete the installation.

4 Proceed with the installation according to the instructions on the screen.

5 You will be requested to restart, so conduct a restart by following the instructions.

Uninstalling software

Window

- 1 Exit DSS Player program.
- 2 Click the [start] button on the taskbar.
- 3 Select [Add/Remove programs] from the [Control Panel].
 - A list of installed applications is displayed.
- 4 Select [Olympus DSS Player Standard], then click the [Change/Remove] button.
- 5 Proceed with the uninstallation according to the instructions on the screen.

Macintosh

- 1 Exit DSS Player program.
- 2 Double-click [DSS Uninstaller] in [Application] → [DSS Player] folder.
 - An uninstaller is displayed.
- 3 Proceed with the uninstallation according to the instructions on the screen.

Note

- The dictation files you made are stored in the [MESSAGE] folder. If you don't need them, delete them.
You can confirm the location of the [MESSAGE] folder by clicking on [Options] in the [Tools] menu before uninstalling.

Using online help

For information on the DSS Player usage and features, refer to the Online help.

To start online Help:

Windows

- 1 Click the [start] button, then select [All Programs], [Olympus DSS Player Standard], [Dictation Module Help].
- 2 While DSS Player is running, select the [Help] menu, [Contents].
- 3 While DSS Player is running, press F1 on the keyboard.

Macintosh

- 1 While DSS Player software is running, select [DSS Player Help] from the [Help] menu.

Note

- The Online help will be available after DSS Player software installation.

4

Connecting recorder to PC

Connecting to your PC using the USB cable

- 1 **Boot the PC.**
- 2 **Connect the USB cable to the USB port of the PC.**
- 3 **Connect the USB cable to the connecting terminal on the bottom of the recorder.**

- **[Remote (Composite)]** is displayed on the recorder if the USB cable is connected.

Once you connect the recorder to your PC, the recorder will be powered through the USB cable.

While PC connection, the SD card is recognized as the respective removable disk drive.

Notes

- NEVER remove the card or disconnect the USB cable while the record indicator light is flashing. If you do, the data will be destroyed.
- Some PC's may not supply sufficient power and the recorder fails to connect. Refer to your PC user's manual regarding the USB port on your PC.
- Do not connect the recorder to a PC by using a USB hub. Make sure to connect to a USB port on your PC.
- Make sure to push the cable connector all the way in. Otherwise, the recorder may not operate properly.

Disconnecting from your PC

Windows

- 1 Click  on the task bar located at the lower-right corner of the screen. Click **[Safely remove USB Mass Storage Device]**.
 - The drive letter will differ depending on the PC being used.
- 2 **Confirm that the record indicator light turns off before disconnecting the USB cable.**

Macintosh

- 1 **Move the icon of the recorder's drive displayed on desktop to trash box by drag and drop.**
- 2 **Disconnect the USB cable.**

Notes

- NEVER remove the card or disconnect the USB cable while the record indicator light is flashing. If you do, the data on the card will get destroyed.
- Some PC's may not supply sufficient power and the recorder fails to connect. Refer to your PC user's manual regarding the USB port on your PC.
- Do not connect the recorder to a PC by using a USB hub. Make sure to connect to a USB port on your PC.
- Make sure to push the cable connector all the way in. Otherwise, the recorder may not operate properly.
- This is an operational environment for saving the files recorded by this recorder to your PC with USB connection.
- Even if operational environment is satisfied, we do not support upgraded OS, the multi-boot environment or self-modified computers.

Running DSS Player Software

By default, connecting the recorder to your PC, will start the application automatically.

Windows

Disabling automatic start:

- 1 Right-click the Device Detector in the System Tray in the lower right-hand corner of the screen, then select [Settings startup application].**
- 2 Click [DSS Player Standard].**
 - The check mark on [DSS Player Standard] disappears.

Manual start:

- 1 Click the [start] button, then select [All Programs].**
 - All program menu will be displayed.
- 2 Select [Olympus DSS Player Standard], then click [Dictation Module].**

Macintosh

Disabling automatic start:

- 1 Click the Dock's System Preferences.**
- 2 Click Device Detector.**
- 3 Turn the automatic startup setting Off.**

Manual start:

- 1 Double click the DSS Player icon for the folder in [Application] → [DSS Player].**
 - All program menu will be displayed.
- 2 Register user information.**
 - The user's registration screen will be displayed at the time of initial startup. Please input the serial number. Please see the seal attached to the CD-ROM package included with the DSS Player, for the serial number. After the input has ended, click [OK] to complete the registration.

Using as external memory of the computer

When the recorder is connected to your PC, it will be recognized on your PC as a removable drive. You can view and access the recorder card from My Computer and download data from the card to your PC using standard windows copy/move and delete commands. You can also upload data from the PC to the card in the recorder in the same way.

Example: Copying Data from PC to Card Using Explorer or Finder

1 Connecting the recorder to your PC.

- For connection procedure, refer to "Connecting to Your PC Using the USB Cable" (P.56).

2 Open Windows Explorer or Finder window.

- [Removable disk] is displayed.

3 Copy the data.

- The recorder will appear as a removable drive icon.

4 Unplug the recorder from a computer.

Note

- NEVER remove the card or disconnect the USB cable while the record indicator light is flashing. If you do, the data on the card will get destroyed.

Alarm message list

Message	Explanation	Action
[Battery Low]	Battery power is getting low.	Charge the batteries or replace with new batteries (☞ P.12, P.14, P.15).
[File Protected]	Attempt to delete a locked file.	Unlock the file from the file menu (☞ P.42).
[Index Full]	The file is full of index marks (maximum of 32 marks).	Erase index marks that are no longer required (☞ P.38).
[Folder Full]	The folder is full of files (maximum of 200 files).	Erase unnecessary files (☞ P.32).
	The destination folder already has the maximum number of files (200).	Erase unnecessary files (☞ P.32).
[Erase Error]	An error occurred while erasing.	Erase once again. When an Erase Error occurs format the card.
[Card Error]	An incompatible card was inserted.	Insert a compatible card (☞ P.19).
[Unsupported Card]	The card cannot be used with this recorder.	Please remove the card.
[Memory Full]	The card has no remaining memory.	Erase files that are no longer required or insert another card.
[Format Error]	There was an error while formatting the card.	Reformat the card (☞ P.50).
[System Error]	System error detected in the recorder.	This is a malfunction. Contact the place of purchase or Olympus Service Center for repair.
[Insert Card]	There is no card inserted.	Insert a card (☞ P.19).
[Can't make the system file. Connect to PC and delete unnecessary file]	The management file cannot be created due to insufficient space on the card.	Connect the recorder to a computer and delete unnecessary files.

Troubleshooting

Symptom	Probable cause	Action
Nothing appears on the display	The batteries are not loaded properly.	Verify polarity is correct (☞ P.12).
	The batteries are dead.	Charge the batteries or replace with new batteries (☞ P.12, P.14, P.15).
	The recorder is in power off mode.	Turn the power on (☞ P.17).
Won't start	The recorder is in power off mode.	Turn the power on (☞ P.17).
	The batteries are dead.	Charge the batteries or replace with new batteries (☞ P.12, P.14, P.15).
Unable to record	The card does not have enough memory.	Erase unnecessary files or insert another card (☞ P.19, P.32).
	The card is unformatted.	Format the card (☞ P.50).
	The maximum number of files has been reached.	Change to any other folder (☞ P.36).
	The SD card is locked.	Unlock the SD card lock.
No playback tone heard	The earphone is connected.	Unplug the earphones to use the internal speaker.
	The volume level is set to [00].	Adjust the volume level (☞ P.30).
Unable to erase	The file is locked.	Unlock the file from the file menu (☞ P.42).
	The SD card is locked.	Unlock the SD card lock.
Noise heard during playback	The recorder was shaken during recording.	————
	The recorder was placed near a cell phone or fluorescent lamp while recording or during playback.	Move the recorder.
Recording level too low	The microphone sensitivity is too low.	Set the microphone sensitivity to Conference mode and try again (☞ P.27).

Symptom	Probable cause	Action
Unable to set index marks	The maximum number of index marks (32) has been reached.	Erase unnecessary index marks (☞ P.38).
	The file is locked.	Unlock the file from the file menu (☞ P.42).
	The SD card is locked.	Unlock the SD card lock.
Cannot recharge	[Battery] is set to [Alkaline].	When using the supplied rechargeable batteries, set the battery setting to [Ni-MH]. Also, please avoid using the batteries outside the recommended temperature range (☞ P.13, P.16).
	You have not pressed the PLAY/OK button.	When using the USB connection, follow the confirmation display and press the PLAY/OK button.
	[USB Class] is set to [Composite].	Stop the operation on the recorder. Charge will start 1 minute after the end of the operation. Please close the applications in use.
Cannot find the recorded file	Wrong folder.	Switch to the right folder (☞ P.36).
Cannot connect to a PC	Sometimes a connection cannot be made with some PCs running Windows XP or Vista.	You need to change the PC's USB settings. See DSS Player Online help for details (☞ P.55).

Technical assistance and support

The following are contact information for technical support for Olympus recorders and software only.

- **Technical Hotline Number in the U.S. and Canada**
1-888-553-4448
- **User Support E-mail address in the U.S. and Canada**
distec@olympus.com
- **Technical Hotline Number in Europe**
Toll free number: 00800 67 10 83 00
available for Austria, Belgium, Denmark, Finland, France, Germany, Italy, Luxemburg, Netherlands, Norway, Portugal, Spain, Sweden, Switzerland, United Kingdom
Charged numbers for the Rest of Europe
+ 49 180 567 1083
+ 49 40 23773 4899
- **User Support E-mail address in Europe**
Audio.Support@olympus-europa.com

Accessories (optional)

- **Headset: E62, E102**
Stereo headset for your PC. A helpful tool for PC based transcription.
- **Monaural binaural earphone: E20**
- **Noise-cancellation microphone: ME12 (Dictation microphone)**
Used to get crisp recordings of your own voice by reducing the effects of ambient noise.
Recommended to improve the accuracy when using voice-recognition software.
- **External microphone: ME15**
A lavalier omni-directional microphone that clips to clothing. Used to record your own voice or people near you.
- **Highly sensitive noise-cancellation monaural microphone: ME52W**
This microphone is used to record sound at a distance while minimizing surrounding noise.
- **Connecting cord: KA333**
Use to connect the microphone jack of the recorder to a radio or other sound source.
- **Telephone pickup microphone: TP8**
Earphone type microphone can be plugged into your ear while phoning. The voice or conversation over the phone can be clearly recorded.
- **Ni-MH rechargeable battery and charger set: BC400 (Europe only)**
BC400 comes with an Ni-MH rechargeable battery charger (BU-400) and 4 Ni-MH rechargeable batteries (BR401) as a pack. This charger can quick charge Olympus AA or AAA Ni-MH rechargeable batteries.
- **Ni-MH rechargeable battery: BR404**
High-efficiency rechargeable long life batteries.
- **USB connecting AC adapter: A514**
DC5V AC Adapter for USB connection.
- **Docking Station: CR10**

Specifications

General points

- **Recording format:**
DS2 (Digital Speech Standard Pro)
- **Recording media:**
SD-card: 512 MB to 32 GB
- **Input level:**
- 70 dBv
- **Sampling frequency:**
[QP] mode: 16 kHz
[SP] mode: 12 kHz
- **Overall frequency response:**
[QP] mode: 200 Hz to 7,000 Hz
[SP] mode: 200 Hz to 5,000 Hz
- **Recording time (2 GB Card):**
[QP] mode: 148 h.
[SP] mode: 303 h.
- **Guide to battery life**
The following values are strictly references.

Alkaline batterie

During recording mode (Built-in microphone):

[QP] mode: Approx. 40 h.
[SP] mode: Approx. 50 h.

During playback mode (Earphone playback):

All mode: Approx. 48 h.

Ni-MH rechargeable batteries

During recording mode (Built-in microphone):

[QP] mode: Approx. 30 h.
[SP] mode: Approx. 37 h.

During playback mode (Earphone playback):

All mode: Approx. 35 h.

- **Speaker:**
Built-in \varnothing 23mm round dynamic speaker
- **MIC/EAR jack:**
 \varnothing 3.5 mm mini-jack, impedance
MIC 2 k Ω , EAR 8 Ω or more
- **Maximum working output (3 V DC):**
300 mW or more (8 Ω speaker)

- **Maximum headphone output:**
 \leq 150 mV (according to EN 50332-2)
- **Input power requirement:**
Batteries: Two AAA batteries (LR03) or
two Ni-MH rechargeable batteries
External power supply:
USB connecting AC adapter (A514) 5 V
- **External dimensions:**
113.5 mm \times 50.0 mm \times 17 mm
(without protrusions)
- **Weight:**
105 g (Including alkaline batteries)
- **Operating temperature:**
0°C - 42°C / 32°F - 107.6°F

Memory sizes of cards and approximate recording times *1

Memory size	[QP] mode	[SP] mode
512 MB	37.5 hr.	77 hr.
1 GB	73 hr.	150 hr. *2
2 GB	148 hr. *2	303 hr. *2
4 GB	290 hr. *2	595 hr. *2
8 GB	588 hr. *2	1205 hr. *2
16 GB	1178 hr. *2	2413 hr. *2
32 GB	2363 hr. *2	4843 hr. *2

The above are the standard times, and the available recording time will vary depending on the card.

*1: Available recording time for one continuous file.

Available recording time may be shorter if many short recordings are made.

*2: Total recording time of several files. The maximum recording time per file is 99 hours 59 minutes.

Specifications and design are subject to change without notice.

Battery life is measured by Olympus. It varies greatly according to the type of batteries used and the conditions of use.

OLYMPUS[®]

OLYMPUS IMAGING CORP.

Shinjuku Monolith, 3-1 Nishi-Shinjuku 2-chome, Shinjuku-ku, Tokyo 163-0914, Japan.

Tel. +81 (0)3-3340-2111

<http://www.olympus.com>

OLYMPUS IMAGING AMERICA INC.

3500 Corporate Parkway, P.O. Box 610, Center Valley, PA 18034-0610, U.S.A. Tel. 1-888-553-4448

<http://www.olympusamerica.com>