

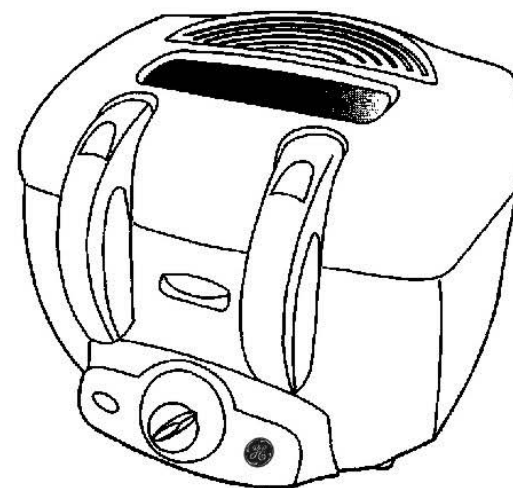

Three Basket Deep Fryer



Item Stock Number
168946

UPC:
681131689465

www.gehousewares.com

For product service, call customer service at (877) 207-0923

Deep Fryer Safety

IMPORTANT SAFEGUARDS

When using electrical appliances, basic safety precautions should always be followed, including the following:

1. Read all instructions before using.
2. Do not touch hot surfaces. Use handles or knobs.
3. To protect against electric shock, do not immerse Removable Control Pod, cord or plugs in water or other liquids.
4. Close supervision is necessary when any appliance is used near children. This appliance is not to be used by children.
5. Unplug from outlet when not in use and before cleaning. Allow to cool before putting on or taking off parts, and before cleaning the appliance.
6. Do not operate any appliance with a damaged cord or plug or after the appliance malfunctions, or has been damaged in any manner. Return appliance to manufacturer (see warranty) for examination, repair, or adjustment.
7. The use of accessory attachments not recommended by manufacturer may cause injuries.
8. Do not use outdoors.
9. Do not let cord hang over the edge of table or counter; or touch hot surfaces.
10. Do not place on or near a hot gas or electric burner, or in a heated oven.
11. Extreme caution must be used when moving fryer containing hot oil.
12. Always attach plug to appliance first, then plug cord in the wall outlet. To disconnect, turn control to lowest temperature, then remove plug from wall outlet.

13. Do not use appliance for other than intended use.

14. Be sure handle is properly assembled to basket and locked in place. (See detailed disassembly/assembly sequence)

SAVE THESE INSTRUCTIONS!

Consumer Safety Information

THIS APPLIANCE IS INTENDED FOR HOUSEHOLD USE ONLY

This appliance has a polarized plug (one blade is wider than the other). To reduce the risk of electric shock, this plug will fit in a polarized outlet only one way. If the plug does not fit fully in the outlet, reverse the plug. If it still does not fit, contact a qualified electrician. Do not attempt to modify the plug in any way.

Congratulations on the purchase of your New GE Deep Fryer. This Deep Fryer is equipped with a Break-away Power Cord System, which includes a detachable magnetic cord designed to separate from the unit when certain amounts of force are applied.

NOTE : This cord meets revised Underwriter's Laboratories (UL) Standard 1083 requirements effective May 30, 2001.

A short power supply cord is provided to reduce the risk resulting from becoming entangled in or tripping over a longer cord.

WARNING: Do not use an extension cord.

No user-serviceable parts inside Removable Control Pod. Do not attempt to service this products.

Three Basket Deep fryer

Parts and Features

- ❶ Spring loaded removable lid
- ❷ Lid location guides x 2
- ❸ Viewing window
- ❹ Steam vents
- ❺ Lid release button
- ❻ Baskets x 3
- ❼ Basket handle x 2
- ❽ Basket lower release button
- ❾ Basket rest (not shown)
- ❿ Lid lock catch
- ⓫ Basket handle location guides x 2
- ⓬ Removable bowl
- ⓭ Power on light
- ⓮ Temperature ready light
- ⓯ Variable temperature control
- ⓰ Min and max oil levels inside bowl
- ⓱ Non slip feet on base
- ⓲ Removable control pod

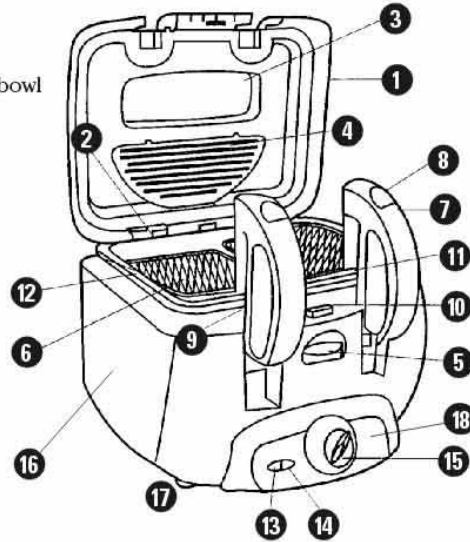
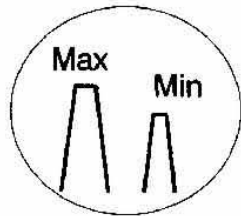

Getting to know your new deep fryer

Before using your deep fryer for first time

- Read all sections of the instruction manual carefully.
- Remove all packaging materials including plastic bags, instruction manual, notices and labels inside.
- Raise the basket handle to its highest position (a click will be heard) and then lift the basket out of the fryer.
- Make sure the fryer is unplugged. Clean the frying basket and cooking pot with hot water, a small amount of dishwashing liquid and a non-abrasive sponge or cleaning pad. Never immerse the body of the unit in water. Wipe the inside of the lid and the outer housing with a clean, damp cloth.
- Dry all parts of your fryer thoroughly and replace the lid, bowl and basket(s). Insert the bowl with the max/min lines to the rear.
- The fryer body or removable control pod❷ must never be immersed in water or any other liquid.
- Never operate with the oil level below minimum mark (2.0 litres) or above maximum mark (2.5 litres).

CAUTION: Never connect the fryer to the electricity supply without oil in the bowl.

Operation

Lid operation

To install the lid, simply locate in the guides and slide the spring into the slot. Close the lid by pressing down in the center and ensure locking catch is fully engaged.

Press the lid release button, the lid is spring loaded and will rise up on its own. In the upper position the lid will lift out of its guides at the back for easy cleaning. To replace, locate in the guides and slide back into position.

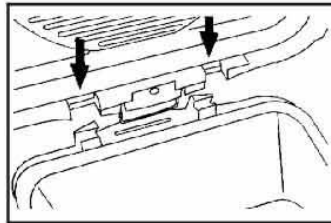

Basket operation

The handles are removable so they can be attached to the 2 small or 1 large basket.

• Removal of handles -

Press the handle down straight against the spring and pull away from the basket to remove.

Note: Please place the basket on table and hold the basket firmly with one hand. Push down hard on the handle until a "click" sound is heard to remove basket(s).

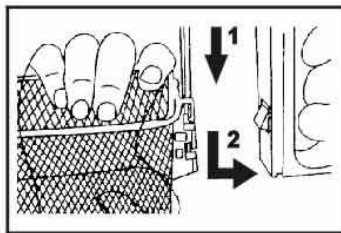

• Attaching the handle to a basket -

Align the handle with the slots of the basket, push in and then pull straight upwards against the spring.

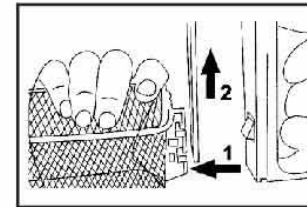

• Basket Insertion and Positioning -

With the lid open, the basket can be raised into the rest/draining position or removed completely.

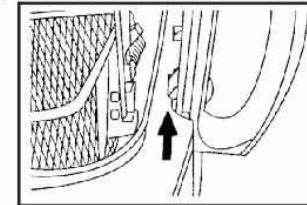

When lowering the basket into the fryer, position the basket handles over the guide rails on the front of the fryer. This will put the basket into the rest/draining position. When in the rest/draining position, the basket handle is automatically locked on the basket rest lip (shown by arrow). Press the basket release button to lower the basket into the cooking position.

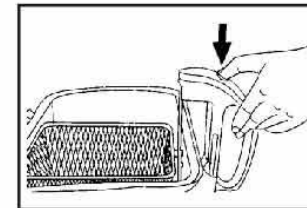

When using the large single basket, both basket release buttons must be pressed to allow the basket to lower into the oil.

Disassembly/Assembly sequence

The fryer has to be disassembled and assembled in the following order.

1. Unplug from the wall outlet and remove power cord from the fryer.
2. Open the lid and remove.
3. Remove the baskets.
4. Lift out the tank.
5. Pull out the removable control pod.

Assembly is the reverse of the above process.

Removal of control pod

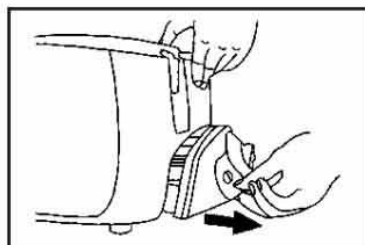

1. Unplug from the wall outlet and remove power cord from the fryer.
2. Grip the removable control pod as shown and pull out.
3. Replace by locating pod in the guides and push in fully.

General cooking method

1. Place baskets in the raised position. The basket should be in the raised position when it is to be filled with food.
2. Place food into the raised basket. The food should be as dry as possible. When frying frozen food, shake the basket to remove excess ice and frost. The oil temperature and oil life expectancy will be improved.

CAUTION: The oil may splatter as the food is added.

3. Close the lid, lower the basket into the oil.
 - You can observe the cooking process by raising the lid or looking through the viewing window to observe progress.
4. When the food is cooked, raise the basket then lift the lid, and place it in its raised rest position for a few seconds to drain.
5. Lift the basket out and shake the fried food into a dish prepared with paper towels to remove excess oil.
6. After use, disconnect from the main supply and allow to cool. Wipe any oil from the fryer body.

Cooking home-battered foods

This method allows for the fact that if wet batter is placed in the basket prior to cooking the food may stick.

- It is advised that the large basket is used.
1. Leave the baskets in the down position.
 2. Coat the raw food in the batter and allow it to drain slightly to get rid of the excess coating.
 3. Very carefully, slowly lower the coated food into the hot oil, using a suitable implement or tongs. This allows the batter to become solid and prevents it from sticking to the mesh of the basket.
 4. When food is cooked, raise the basket and lift the lid out of oil into rest/drain position and let drain for a few seconds.

WARNING: Use caution as the oil may splatter as the food is added.

Getting the best from your fryer

Oil

- Always ensure that you use good quality oil for deep frying. We recommend liquid vegetable oils, alternatively use corn, groundnut or rapeseed oil. Avoid mixing oils of different types and quality.
- Solid fat (lard) and solid oil can be used, this should be melted in a pan first until softened, then carefully transferred into the fryer bowl.
- Change the oil when it becomes brown or cloudy in color.

Cooking

- Food must always be completely dry in order to avoid overflowing. This will also prolong the use of the oil and give a crisper finish to the food.
- As a general guide raw foods need a higher cooking temperature than pre-cooked foods.
- Do not overload the basket(s) as it may cause a drop of temperature that may leave the food greasy.
- Cook your food thoroughly. Remember that your food may begin to turn golden brown before it is cooked through.
- Avoid leaving food to drain for too long in the basket as the food may become soft and lose its crunchiness.
- Select your cooking utensils with care. Do not use utensils that may melt. Metal utensils become hot and therefore should have insulated handles. When using metal utensils, take care not to damage the non-stick coating of the bowl.
- All foods contain moisture. When lowered into the hot oil the water turns to steam. Use caution when opening the lid, as trapped steam will be very hot.

IMPORTANT: Never fill the basket more than 1/2 to 2/3 full of food(1/4 to 1/2 is best), since this will cause the temperature of the oil to decrease below the optimal frying temperature and result in foods that are not as light or crispy as they can be.

French fries

- Old potatoes are ideal for making french fries. Your french fries should be evenly sized so that they cook evenly. They should be rinsed in a colander under a cold tap and dried using a kitchen towel or absorbent paper. For best results fry your french fries for 10 - 12 minutes; shaking the basket at intervals to ensure french fries get an overall browning.
- For best results, we recommend no more than 900g/31oz of frozen french fries or 1200g/42oz of fresh french fries are fried.

Filter removal and replacement

The lid is fitted with a replaceable charcoal and grease filter which collects oil from passing steam. The filter can be used for about 15 frying sessions, it must be changed to maintain the effectiveness of the odor filter system.

1. Lift the filter panel from the lid by pressing the tab and lifting upwards, remove the black charcoal and white cotton filter and discard.
2. Insert the new white grease filter first then the black charcoal filter, replace the panel. Contact the customer service number for replacement filter packs.

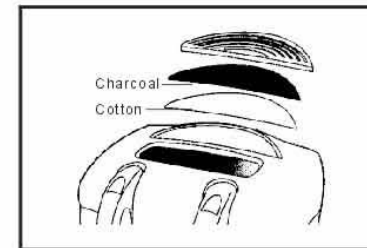

Emptying and cleaning

WARNING:

Cleaning should only be carried out with the plug removed from the socket. The fryer should have completely cooled. Allow 3 hours for cooling.

1. Remove the lid.
2. Remove the baskets.
3. Lift out the bowl.

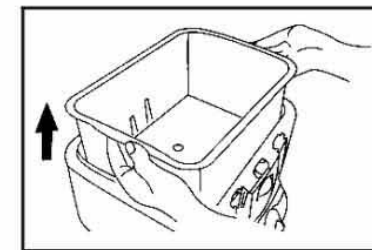

4. Pour out the oil through fine muslin or absorbent paper placed in a suitable funnel into a container.
5. Wash the lid, basket, handles and the inside of the tank by hand with hot soapy water. Always remove the two-piece filter before cleaning the lid.
 - The lid can be washed in a dishwasher.
 - The basket and bowl should NOT be washed in a dishwasher.
6. Clean the body of the fryer with a warm moistened cloth, mild dish soap can be used.

IMPORTANT: Never immerse the removable control pod in water. Remove any stains with a moistened cloth.

7. Dry all parts of your fryer thoroughly and reassemble all parts with max and min at the back of the bowl. (Refer to the disassembly / assembly sequence.)
 - The outside of the bowl is not non-stick coated, if care is taken, it is unlikely to become dirty. If oil does drip down the exterior when the oil is being emptied out, make sure that it is hand-washed thoroughly. The exterior may appear discolored, this is quite normal and will not affect the performance of the fryer.

Frying Time and Temperature

The frying times in this chart are a guide and should be adjusted to suit the different quantities or thickness of food and to suit your own taste.

FOOD	TEMP. SETTING	TIME (MINUTES)
Chicken Strips	375° F	5 to 8
Chicken pieces, bone-in	360° F	15 to 20
Fish, Battered	375° F	4 to 5
French fries, frozen	Follow directions on package	
Fritters	375° F	2 to 4
Onion Rings	375° F	2 to 3
Shrimp, breaded	360° F	2 to 4

Recipes

French fries

1 large potato	1 tablespoon olive oil
1/2 teaspoon paprika	1/2 teaspoon garlic powder
1/2 teaspoon chili powder	1/2 teaspoon onion powder

1. Preheat oil to 350° F.
2. Cut potato into wedges. Mix olive oil, paprika, garlic powder, chili powder and onion powder together. Coat potatoes with oil/spice mixture and place in the deep fryer.
3. Fry for 10-15 minutes until golden brown.

Beer battered fried vegetables

2 cups all-purpose flour	1-1/2 cups beer
2 eggs	1 cup milk
Salt and pepper to taste	1 carrot, cut into thick strips
1 onion, sliced into rings	6 fresh mushrooms, stems removed
1 green bell pepper	

1. In a medium bowl, mix together 1-1/2 cup flour and beer with a wooden spoon; let stand for at least 3 hours at room temperature.
2. Mix eggs and milk in a small bowl. In a separate bowl mix together 1/2 cup flour and salt and pepper.
3. Preheat oil to 375° F.
4. Dip each vegetable in the egg and milk mixture, then dip the vegetable into the flour and seasoning mixture. Next, dip the vegetable in the beer and flour mixture. Place the vegetables into the oil and fry until golden brown.

Easy fried chicken

12-oz. can evaporated milk	2 cups corn flake cereal crumbs
Salt and pepper to taste	2 to 4 boneless, skinless chicken breasts

Slice chicken lengthwise to make approximately 3 strips for each breast. Place strips in a large bowl and cover with evaporated milk. Preheat oil to 350° F. Shake excess milk off chicken strips; coat strips with corn flake cereal crumbs. Place in heated oil. Fry chicken until golden brown. Drain on paper towels. Salt and pepper to taste.

Easy doughnuts

2 cups flour	1 teaspoon baking powder
2 pinches baking soda	1/4 teaspoon salt
1 egg	1/2 cup sugar
1/2 cup buttermilk	1/2 teaspoon vanilla extract

1. Sieve flour, baking soda and baking powder together in a bowl.
2. In another bowl beat egg well. Add sugar and beat again. Then add vanilla extract and beat again.
3. Mix this beaten mixture with the flour.
4. Add the buttermilk, then make a dough.
5. Put this aside for 10 minutes.
6. Then roll out into 1/2 inch thick layer on a floured surface.
7. Cut it with a doughnut cutter.
8. Preheat the oil to 350° F and deep fry until golden brown.
9. Sprinkle powdered sugar on the doughnuts.

Customer Assistance

If you have a claim under this warranty, please call our Customer Assistance Number. For faster service please have model, series, and type numbers ready for operator to assist you. These numbers can be found on the bottom of your Deep Fryer.

MODEL: _____ TYPE: _____ SERIES: _____

Customer Assistance Number 1-877-207-0923

Keep this number for future reference!

Two-Year Limited Warranty

What does your warranty cover?

- Any defect in material or workmanship.

For how long after the original purchase?

- Two years.

What will we do?

- Provide you with a new unit.

- The exchange unit is warranted for the remainder of your product's original two-year warranty period.

How do you make a warranty claim?

- Properly pack your unit. We recommend using the original carton and packing materials.
- Include in the package a copy of the sales receipt or other evidence of date of original purchase. If the unit was a gift, provide a statement specifying the date received. Also print your name and address and a description of the defect.
- Return the product to your nearest WAL★MART store or call Customer Assistance at 1-877-207-0923.



is a trademark of
General Electric Company
and is used under license by
WAL★MART Stores, Inc.
Bentonville, AR 72718

What does your warranty not cover?

- Glass parts, glass containers, cutter/strainer, blades and/or agitators.
- Commercial use or any other use not found in printed directions.
- Damage from misuse, abuse, or neglect.
- Products purchased or serviced outside the USA.

How does state law relate to this warranty?

- This warranty gives you specific legal rights, and you may also have other rights which vary from state to state.
- WAL★MART expressly disclaims all responsibility for consequential damages or incidental losses caused by use of this appliance. Some states do not allow this exclusion or limitation of incidental or consequential losses so the foregoing disclaimer may not apply to you.

What if you purchased your product in the U.S., Canada or Mexico and encounter a problem while using it outside the country of purchase?

- The warranty is valid only in the country of purchase and if you follow the warranty claim procedure as noted.