

Sanding Center 6" Belt/12" Disc Sander (Model 31-300)

INSTRUCTION MANUAL



PART NO. 913131 - 04-12-05
Copyright © 2005 Delta Machinery

 **DELTA[®] INDUSTRIAL**

To learn more about DELTA MACHINERY
visit our website at: www.deltamachinery.com.

For Parts, Service, Warranty or other Assistance,

please call **1-800-223-7278** (In Canada call **1-800-463-3582**).

TABLE OF CONTENTS

IMPORTANT SAFETY INSTRUCTIONS	2
SAFETY GUIDELINES	3
GENERAL SAFETY RULES	4
ADDITIONAL SPECIFIC SAFETY RULES	5
FUNCTIONAL DESCRIPTION	8
CARTON CONTENTS	8
ASSEMBLY	9
OPERATION	12
TROUBLESHOOTING	20
MAINTENANCE	20
SERVICE	20
ACCESSORIES	21
WARRANTY	21
SERVICE CENTER LOCATIONSback cover

IMPORTANT SAFETY INSTRUCTIONS

▲WARNING Read and understand all warnings and operating instructions before using any tool or equipment. When using tools or equipment, basic safety precautions should always be followed to reduce the risk of personal injury. Improper operation, maintenance or modification of tools or equipment could result in serious injury and property damage. There are certain applications for which tools and equipment are designed. Delta Machinery strongly recommends that this product NOT be modified and/or used for any application other than for which it was designed.

If you have any questions relative to its application DO NOT use the product until you have written Delta Machinery and we have advised you.

Online contact form at www.deltamachinery.com

Postal Mail: Technical Service Manager
Delta Machinery
4825 Highway 45 North
Jackson, TN 38305

(IN CANADA: 505 SOUTHGATE DRIVE, GUELPH, ONTARIO N1H 6M7)

Information regarding the safe and proper operation of this tool is available from the following sources:

Power Tool Institute
1300 Sumner Avenue, Cleveland, OH 44115-2851
www.powertoolinstitute.org

National Safety Council
1121 Spring Lake Drive, Itasca, IL 60143-3201

American National Standards Institute, 25 West 43rd Street, 4 floor, New York, NY 10036 www.ansi.org
ANSI 01.1 Safety Requirements for Woodworking Machines, and

the U.S. Department of Labor regulations www.osha.gov

SAVE THESE INSTRUCTIONS!

SAFETY GUIDELINES - DEFINITIONS

It is important for you to read and understand this manual. The information it contains relates to protecting YOUR SAFETY and PREVENTING PROBLEMS. The symbols below are used to help you recognize this information.



- ▲ DANGER** Indicates an imminently hazardous situation which, if not avoided, will result in death or serious injury.
- ▲ WARNING** Indicates a potentially hazardous situation which, if not avoided, could result in death or serious injury.
- ▲ CAUTION** Indicates a potentially hazardous situation which, if not avoided, may result in minor or moderate injury.
- CAUTION** Used without the safety alert symbol indicates potentially hazardous situation which, if not avoided, may result in property damage.

CALIFORNIA PROPOSITION 65

▲ WARNING **SOME DUST CREATED BY POWER SANDING, SAWING, GRINDING, DRILLING, AND OTHER CONSTRUCTION ACTIVITIES** contains chemicals known to cause cancer, birth defects or other reproductive harm.

Some examples of these chemicals are:

- lead from lead-based paints,
- crystalline silica from bricks and cement and other masonry products, and
- arsenic and chromium from chemically-treated lumber.

Your risk from these exposures varies, depending on how often you do this type of work. To reduce your exposure to these chemicals: work in a well ventilated area, and work with approved safety equipment, always wear **NIOSH/OSHA** approved, properly fitting face mask or respirator when using such tools.

GENERAL SAFETY RULES



▲ WARNING READ AND UNDERSTAND ALL WARNINGS AND OPERATING INSTRUCTIONS BEFORE USING THIS EQUIPMENT. Failure to follow all instructions listed below, may result in electric shock, fire, and/or serious personal injury or property damage.

IMPORTANT SAFETY INSTRUCTIONS

- 1. FOR YOUR OWN SAFETY, READ THE INSTRUCTION MANUAL BEFORE OPERATING THE MACHINE.** Learning the machine's application, limitations, and specific hazards will greatly minimize the possibility of accidents and injury.
- 2. WEAR EYE AND HEARING PROTECTION. ALWAYS USE SAFETY GLASSES.** Everyday eyeglasses are NOT safety glasses. USE CERTIFIED SAFETY EQUIPMENT. Eye protection equipment should comply with ANSI Z87.1 standards. Hearing equipment should comply with ANSI S3.19 standards.
- 3. WEAR PROPER APPAREL.** Do not wear loose clothing, gloves, neckties, rings, bracelets, or other jewelry which may get caught in moving parts. Nonslip footwear is recommended. Wear protective hair covering to contain long hair.
- 4. DO NOT USE THE MACHINE IN A DANGEROUS ENVIRONMENT.** The use of power tools in damp or wet locations or in rain can cause shock or electrocution. Keep your work area well-lit to prevent tripping or placing arms, hands, and fingers in danger.
- 5. MAINTAIN ALL TOOLS AND MACHINES IN PEAK CONDITION.** Keep tools sharp and clean for best and safest performance. Follow instructions for lubricating and changing accessories. Poorly maintained tools and machines can further damage the tool or machine and/or cause injury.
- 6. CHECK FOR DAMAGED PARTS.** Before using the machine, check for any damaged parts. Check for alignment of moving parts, binding of moving parts, breakage of parts, and any other conditions that may affect its operation. A guard or any other part that is damaged **should be properly repaired or replaced.** Damaged parts can cause further damage to the machine and/or injury.
- 7. KEEP THE WORK AREA CLEAN.** Cluttered areas and benches invite accidents.
- 8. KEEP CHILDREN AND VISITORS AWAY.** Your shop is a potentially dangerous environment. Children and visitors can be injured.
- 9. REDUCE THE RISK OF UNINTENTIONAL STARTING.** Make sure that the switch is in the "OFF" position before plugging in the power cord. In the event of a power failure, move the switch to the "OFF" position. An accidental start-up can cause injury.
- 10. USE THE GUARDS.** Check to see that all guards are in place, secured, and working correctly to reduce the risk of injury.
- 11. REMOVE ADJUSTING KEYS AND WRENCHES BEFORE STARTING THE MACHINE.** Tools, scrap pieces, and other debris can be thrown at high speed, causing injury.
- 12. USE THE RIGHT MACHINE.** Don't force a machine or an attachment to do a job for which it was not designed. Damage to the machine and/or injury may result.
- 13. USE RECOMMENDED ACCESSORIES.** The use of accessories and attachments not recommended by Delta may cause damage to the machine or injury to the user.
- 14. USE THE PROPER EXTENSION CORD.** Make sure your extension cord is in good condition. When using an extension cord, be sure to use one heavy enough to carry the current your product will draw. An undersized cord will cause a drop in line voltage, resulting in loss of power and overheating. See the Extension Cord Chart for the correct size depending on the cord length and nameplate ampere rating. If in doubt, use the next heavier gauge. The smaller the gauge number, the heavier the cord.
- 15. SECURE THE WORKPIECE.** Use clamps or a vise to hold the workpiece when practical. Loss of control of a workpiece can cause injury.
- 16. FEED THE WORKPIECE AGAINST THE DIRECTION OF THE ROTATION OF THE BLADE, CUTTER, OR ABRASIVE SURFACE.** Feeding it from the other direction will cause the workpiece to be thrown out at high speed.
- 17. DON'T FORCE THE WORKPIECE ON THE MACHINE.** Damage to the machine and/or injury may result.
- 18. DON'T OVERREACH.** Loss of balance can make you fall into a working machine, causing injury.
- 19. NEVER STAND ON THE MACHINE.** Injury could occur if the tool tips, or if you accidentally contact the cutting tool.
- 20. NEVER LEAVE THE MACHINE RUNNING UNATTENDED. TURN THE POWER OFF.** Don't leave the machine until it comes to a complete stop. A child or visitor could be injured.
- 21. TURN THE MACHINE "OFF", AND DISCONNECT THE MACHINE FROM THE POWER SOURCE** before installing or removing accessories, before adjusting or changing set-ups, or when making repairs. An accidental start-up can cause injury.
- 22. MAKE YOUR WORKSHOP CHILDPROOF WITH PADLOCKS, MASTER SWITCHES, OR BY REMOVING STARTER KEYS.** The accidental start-up of a machine by a child or visitor could cause injury.
- 23. STAY ALERT, WATCH WHAT YOU ARE DOING, AND USE COMMON SENSE. DO NOT USE THE MACHINE WHEN YOU ARE TIRED OR UNDER THE INFLUENCE OF DRUGS, ALCOHOL, OR MEDICATION.** A moment of inattention while operating power tools may result in injury.
- 24. ▲ WARNING** USE OF THIS TOOL CAN GENERATE AND DISBURSE DUST OR OTHER AIRBORNE PARTICLES, INCLUDING WOOD DUST, CRYSTALLINE SILICA DUST AND ASBESTOS DUST. Direct particles away from face and body. Always operate tool in well ventilated area and provide for proper dust removal. Use dust collection system wherever possible. Exposure to the dust may cause serious and permanent respiratory or other injury, including silicosis (a serious lung disease), cancer, and death. Avoid breathing the dust, and avoid prolonged contact with dust. Allowing dust to get into your mouth or eyes, or lay on your skin may promote absorption of harmful material. Always use properly fitting NIOSH/OSHA approved respiratory protection appropriate for the dust exposure, and wash exposed areas with soap and water.

ADDITIONAL SPECIFIC SAFETY RULES

▲ WARNING FAILURE TO FOLLOW THESE RULES MAY RESULT IN SERIOUS PERSONAL INJURY.

1. **DO NOT OPERATE THIS MACHINE** until it is completely assembled and installed according to the instructions. A machine incorrectly assembled can cause serious injury.
2. **OBTAIN ADVICE** from your supervisor, instructor, or another qualified person if you are not thoroughly familiar with the operation of this machine. Knowledge is safety.
3. **FOLLOW ALL WIRING CODES** and recommended electrical connections to prevent shock or electrocution.
4. **NEVER TURN THE MACHINE “ON”** before clearing the table/work area of all objects (tools, scraps of wood, etc.). Flying debris is dangerous.
5. **NEVER TURN THE MACHINE “ON”** with the workpiece contacting the abrasive surface. Kickback can occur.
6. **SECURE THE MACHINE** to a supporting surface. Vibration can cause the machine to slide, walk, or tip over.
7. **COVER THE POWER TAKE-OFF SHAFT** when not using accessories. Unguarded rotating shafts can create an entanglement hazard which can result in injury.
8. **USE A DUST COLLECTION SYSTEM.** Some types of wood are known to cause disease or other health problems.
9. **CLEAN THE MACHINE** and dust collector thoroughly when processing different types of workpieces (wood, steel, or aluminum). Combining wood and metal dust can create an explosion or fire hazard. **DO NOT SAND OR POLISH MAGNESIUM.** Fire will result.
10. **PREVENT THE WORKPIECE** from contacting the sanding belt before starting the tool. Loss of control of the workpiece is dangerous.
11. **AVOID AWKWARD OPERATIONS AND HAND POSITIONS.** A sudden slip could cause a hand to move into the abrasive disc or belt.
12. **MAINTAIN A MAXIMUM CLEARANCE OF 1/16"** between the table and the abrasive disc. The workpiece could be drawn into the space between the abrasive disc and the table.
13. **SUPPORT THE WORKPIECE** firmly with a miter gauge, backstop, or work table when sanding with a belt. Hold the workpiece firmly. Loss of control of the workpiece can result in injury.
14. **AVOID KICKBACK** by sanding in accordance with the directional arrows. Feed the workpiece against the downward rotation side of the disc or the forward rotation of the belt. Loss of control of the workpiece can result in injury.
15. **DO NOT SAND** very small or very thin workpieces that cannot be safely controlled. Loss of control of the workpiece can result in injury.
16. **PROPERLY SUPPORT LONG OR WIDE WORKPIECES.** Loss of control of the workpiece is dangerous.
17. **NEVER PERFORM LAYOUT, ASSEMBLY, OR SET-UP WORK** on the table/work area when the machine is running. A sudden slip could cause a hand to move into the abrasive surface. Severe injury can result.
18. **TURN THE MACHINE “OFF”**, disconnect the machine from the power source, and clean the table/work area before leaving the machine. **LOCK THE SWITCH IN THE “OFF” POSITION** to prevent unauthorized use. Someone else might accidentally start the machine and cause injury to themselves.
19. **ADDITIONAL INFORMATION** regarding the safe and proper operation of power tools (i.e. a safety video) is available from the Power Tool Institute, 1300 Sumner Avenue, Cleveland, OH 44115-2851 (www.powertoolinstitute.com). Information is also available from the National Safety Council, 1121 Spring Lake Drive, Itasca, IL 60143-3201. Please refer to the American National Standards Institute ANSI 01.1 Safety Requirements for Woodworking Machines and the U.S. Department of Labor OSHA 1910.213 Regulations.

SAVE THESE INSTRUCTIONS.
Refer to them often and use them to instruct others.

POWER CONNECTIONS

A separate electrical circuit should be used for your machines. This circuit should not be less than #12 wire and should be protected with a 20 Amp time lag fuse. If an extension cord is used, use only 3-wire extension cords which have 3-prong grounding type plugs and matching receptacle which will accept the machine's plug. Before connecting the machine to the power line, make sure the switch (s) is in the "OFF" position and be sure that the electric current is of the same characteristics as indicated on the machine. All line connections should make good contact. Running on low voltage will damage the machine.

▲ DANGER DO NOT EXPOSE THE MACHINE TO RAIN OR OPERATE THE MACHINE IN DAMP LOCATIONS.

MOTOR SPECIFICATIONS

Your machine is wired for 120 volts, 60 HZ alternating current. Before connecting the machine to the power source, make sure the switch is in the "OFF" position.

GROUNDING INSTRUCTIONS

▲ DANGER THIS MACHINE MUST BE GROUNDED WHILE IN USE TO PROTECT THE OPERATOR FROM ELECTRIC SHOCK.

1. All grounded, cord-connected machines:

In the event of a malfunction or breakdown, grounding provides a path of least resistance for electric current to reduce the risk of electric shock. This machine is equipped with an electric cord having an equipment-grounding conductor and a grounding plug. The plug must be plugged into a matching outlet that is properly installed and grounded in accordance with all local codes and ordinances.

Do not modify the plug provided - if it will not fit the outlet, have the proper outlet installed by a qualified electrician.

Improper connection of the equipment-grounding conductor can result in risk of electric shock. The conductor with insulation having an outer surface that is green with or without yellow stripes is the equipment-grounding conductor. If repair or replacement of the electric cord or plug is necessary, do not connect the equipment-grounding conductor to a live terminal.

Check with a qualified electrician or service personnel if the grounding instructions are not completely understood, or if in doubt as to whether the machine is properly grounded.

Use only 3-wire extension cords that have 3-prong grounding type plugs and matching 3-conductor receptacles that accept the machine's plug, as shown in Fig. A.

Repair or replace damaged or worn cord immediately.

2. Grounded, cord-connected machines intended for use on a supply circuit having a nominal rating less than 150 volts:

If the machine is intended for use on a circuit that has an outlet that looks like the one illustrated in Fig. A, the machine will have a grounding plug that looks like the plug illustrated in Fig. A. A temporary adapter, which looks like the adapter illustrated in Fig. B, may be used to connect this plug to a matching 2-conductor receptacle as shown in Fig. B if a properly grounded outlet is not available. The temporary adapter should be used only until a properly grounded outlet can be installed by a qualified electrician. The green-colored rigid ear, lug, and the like, extending from the adapter must be connected to a permanent ground such as a properly grounded outlet box. Whenever the adapter is used, it must be held in place with a metal screw.

NOTE: In Canada, the use of a temporary adapter is not permitted by the Canadian Electric Code.

▲ DANGER IN ALL CASES, MAKE CERTAIN THE RECEPTACLE IN QUESTION IS PROPERLY GROUNDED. IF YOU ARE NOT SURE HAVE A QUALIFIED ELECTRICIAN CHECK THE RECEPTACLE.

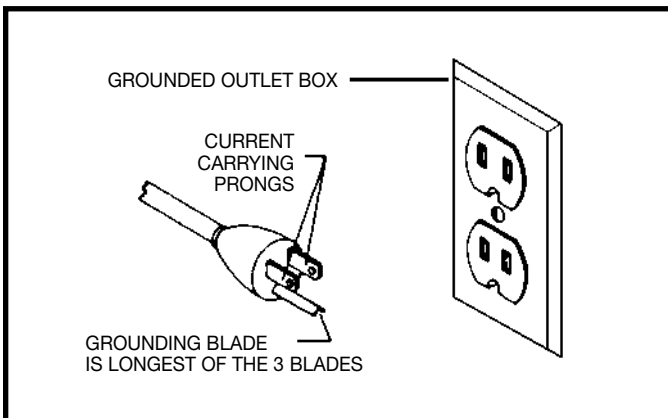

Fig. A

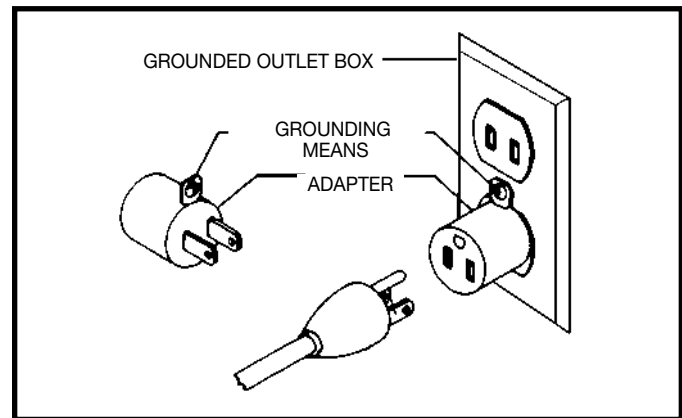

Fig. B

3. 240 VOLT SINGLE PHASE OPERATION

The motor supplied with your saw is a dual voltage, 120/240 volt motor. It is set at the factory at 120 volts. If it is desired to operate your machine at 240 volts, single phase, it is necessary to reconnect the motor leads in the motor junction box by following instructions given on the motor nameplate.

⚠ WARNING MAKE SURE MOTOR IS DISCONNECTED FROM POWER SOURCE BEFORE RECONNECTING MOTOR LEADS.

It is also necessary to replace the 120 volt plug, supplied with the motor, with a UL/CSA listed plug suitable for 240 volts and the rated current of your machine as illustrated in Fig. C. Contact your local Authorized Delta Service Center or qualified electrician for proper procedures to install the plug. The machine must comply with all local and national electrical codes after the 240 volt plug is installed.

The machine with a 240 volt plug should only be connected to an outlet having the same configuration as the plug illustrated in Fig. C. No adapter is available or should be used with the 240 Volt plug.

⚠ WARNING IN ALL CASES, MAKE CERTAIN THE RECEPTACLE IN QUESTION IS PROPERLY GROUNDED. IF YOU ARE NOT SURE HAVE A QUALIFIED ELECTRICIAN CHECK THE RECEPTACLE.

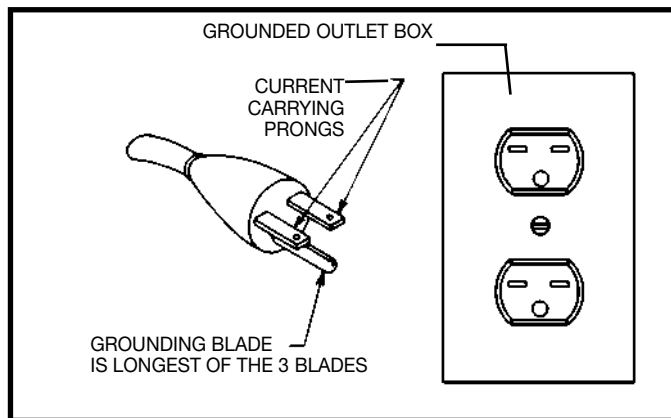

Fig. C

4. Permanently connected machines:

If the machine is intended to be permanently connected, the machine should be connected to a grounded metal permanent wiring system, or to a system having an equipment-grounding conductor.

EXTENSION CORDS

⚠ WARNING Use proper extension cords. Make sure your extension cord is in good condition and is a 3-wire extension cord which has a 3-prong grounding type plug and matching receptacle which will accept the machine's plug. When using an extension cord, be sure to use one heavy enough to carry the current of the machine. An undersized cord will cause a drop in line voltage, resulting in loss of power and overheating. Fig. D-1 or D-2, shows the correct gauge to use depending on the cord length. If in doubt, use the next heavier gauge. The smaller the gauge number, the heavier the cord.

MINIMUM GAUGE EXTENSION CORD			
RECOMMENDED SIZES FOR USE WITH STATIONARY ELECTRIC MACHINES			
Ampere Rating	Volts	Total Length of Cord in Feet	Gauge of Extension Cord
0-6	120	up to 25	18 AWG
0-6	120	25-50	16 AWG
0-6	120	50-100	16 AWG
0-6	120	100-150	14 AWG
6-10	120	up to 25	18 AWG
6-10	120	25-50	16 AWG
6-10	120	50-100	14 AWG
6-10	120	100-150	12 AWG
10-12	120	up to 25	16 AWG
10-12	120	25-50	16 AWG
10-12	120	50-100	14 AWG
10-12	120	100-150	12 AWG
12-16	120	up to 25	14 AWG
12-16	120	25-50	12 AWG
12-16	120	GREATER THAN 50 FEET NOT RECOMMENDED	

Fig. D-1

MINIMUM GAUGE EXTENSION CORD			
RECOMMENDED SIZES FOR USE WITH STATIONARY ELECTRIC MACHINES			
Ampere Rating	Volts	Total Length of Cord in Feet	Gauge of Extension Cord
0-6	240	up to 50	18 AWG
0-6	240	50-100	16 AWG
0-6	240	100-200	16 AWG
0-6	240	200-300	14 AWG
6-10	240	up to 50	18 AWG
6-10	240	50-100	16 AWG
6-10	240	100-200	14 AWG
6-10	240	200-300	12 AWG
10-12	240	up to 50	16 AWG
10-12	240	50-100	16 AWG
10-12	240	100-200	14 AWG
10-12	240	200-300	12 AWG
12-16	240	up to 50	14 AWG
12-16	240	50-100	12 AWG
12-16	240	GREATER THAN 100 FEET NOT RECOMMENDED	

Fig. D-2

FUNCTIONAL DESCRIPTION

FOREWORD

Delta Model 31-300 is an industrial/commercial duty 1-1/2 HP belt/disc sander. The induction-type, ball-bearing motor provides long-lasting, smooth performance. The Sanding Center can provide 3000 SFPM with the belt, and the disc will revolve at 2100 RPM.

NOTICE: THE PHOTO ON THE MANUAL COVER ILLUSTRATES THE CURRENT PRODUCTION MODEL. ALL OTHER ILLUSTRATIONS CONTAINED IN THE MANUAL ARE REPRESENTATIVE ONLY AND MAY NOT DEPICT THE ACTUAL COLOR, LABELING OR ACCESSORIES AND ARE INTENDED TO ILLUSTRATE TECHNIQUE ONLY.

CARTON CONTENTS

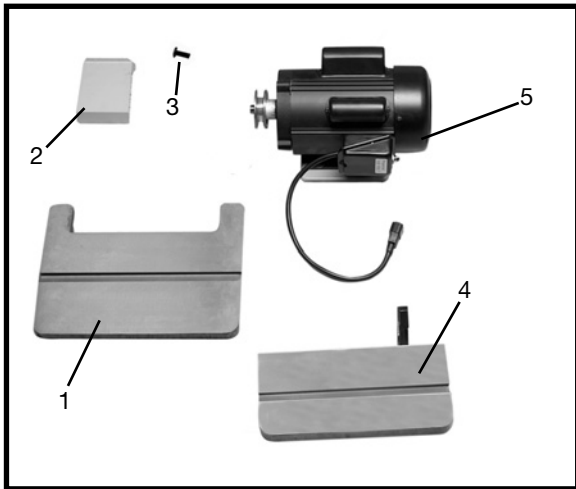

Fig. 2

- 1. Disc Sander Table
- 2. Belt Guard
- 3. #10-32 x 1/2" Machine Screws (4)
- 4. Belt Sander Table
- 5. Motor

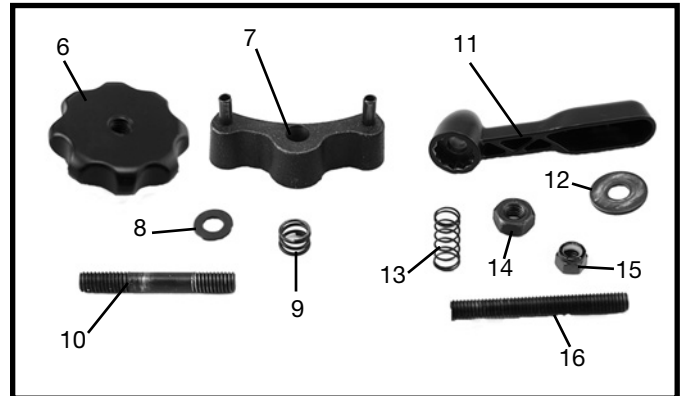

Fig. 3

- 6. Knob (2)
- 7. Clamp (2)
- 8. 7/16" Washer (2)
- 9. Spring (2)
- 10. Stud (2)
- 11. Handle (1)
- 12. 3/8" Washer (1)
- 13. Tension Spring (1)
- 14. 3/8" Hex Nut (1)
- 15. 3/8" Lock Nut (1)
- 16. Stud (1)

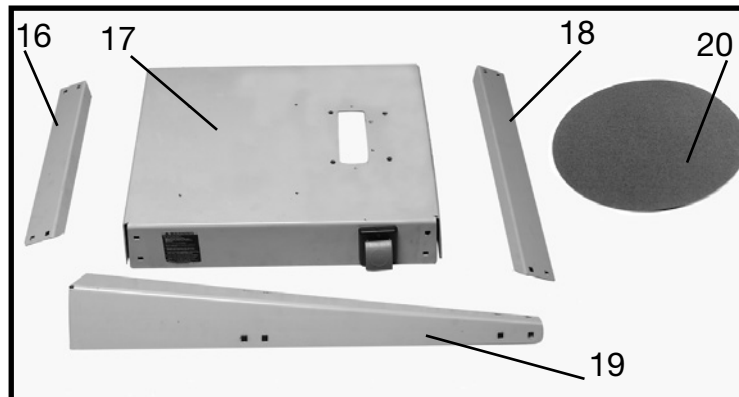

Fig. 4

- 16. Lower Braces (Short) (2)
- 17. Top Shelf
- 18. Lower Braces (Long) (2)
- 19. Legs (4)
- 20. Sanding Disc

For assembling stand:

- 21. 5/16"-18 x 5/8" Carriage Bolt (32)
- 22. 5/16" Lock Washer (32)
- 23. 5/16" Flat Washer (32)
- 24. 5/16"-18 Hex nut (32)

To attach center to stand

- 25. 5/16 x 1/2" Hex Head Bolt (4)
- 26. 5/16" Lock Washer (4)
- 27. #10-32 x 1/2" Machine screws (4)
- 28. #10 Flat Washers (4)

To attach motor to stand:

- 29. 1/2" Flat Washer (2)
- 30. 1/2" Locknut (2)
- 31. 1/2-13 x 3/4" Hex Head Bolt (2)
- 32. 5/16" Lock Washer (2)
- 33. 5/16" Flat Washer (2)
- 34. 5/16" Wing Nut (2)
- 35. 5/16-18 x 1" Carriage Head Bolt (2)

- 36. Pointer and #10-32 Round Head Screw
- 37. Sanding Center

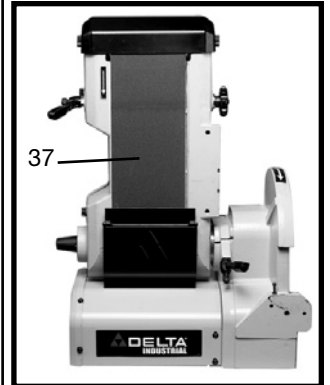
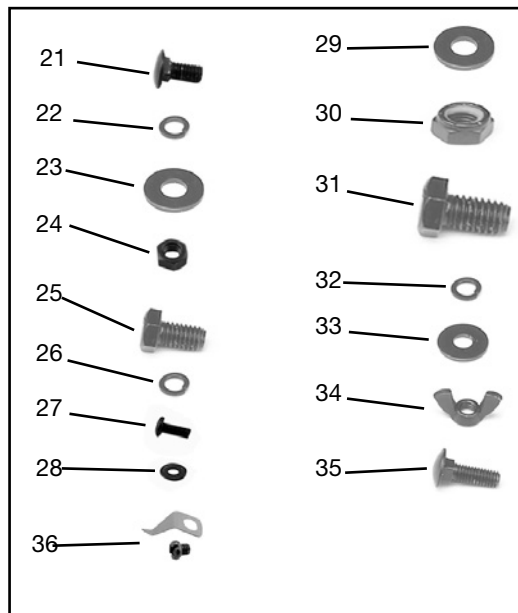

Fig. 5

UNPACKING AND CLEANING

Carefully unpack the machine and all loose items from the shipping container(s). Remove the protective coating from all unpainted surfaces. This coating may be removed with a soft cloth moistened with kerosene (do not use acetone, gasoline or lacquer thinner for this purpose). After cleaning, cover the unpainted surfaces with a good quality household floor paste wax.

ASSEMBLY

ASSEMBLY TOOLS REQUIRED

- * Phillips Head Screwdriver (not supplied)
- * 11/16", 3/4", and 1/2" Socket or Open End Wrenches (not supplied)

ASSEMBLY TIME ESTIMATE - 1-2 hrs.

⚠ WARNING FOR YOUR OWN SAFETY, DO NOT CONNECT THE MACHINE TO THE POWER SOURCE UNTIL THE MACHINE IS COMPLETELY ASSEMBLED AND YOU READ AND UNDERSTAND THE ENTIRE OWNER'S MANUAL.

ASSEMBLING STAND

1. Attach the two short lower braces (A) Fig. 6, and the other two long lower braces (B) to the four legs (C), using the sixteen 5/8" carriage bolts, flat washers, lockwashers, and hex nuts. **NOTE:** Hand tighten the hex nuts for future adjustments.
2. Attach the top shelf (D) to the legs, using the remaining carriage bolts, flat washers, lockwashers, and hex nuts. **NOTE:** Hand tighten the hex nuts for future adjustments.
3. Make sure that the stand is on level ground. Use a helper to lift and position the machine on the top shelf, and tighten all stand hardware securely.

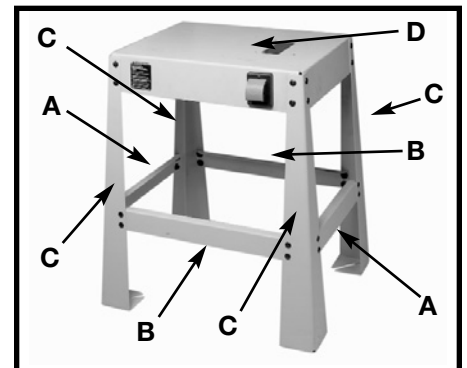

Fig. 6

ATTACHING MOTOR TO STAND

⚠ WARNING DISCONNECT MACHINE FROM POWER SOURCE.

The motor comes with an attachment bracket installed.

1. Locate the welded bracket (A) Fig. 7 underneath the top shelf of the stand.
2. Place the motor attachment bracket (B), so that the holes in the attachment bracket align with the holes in the welded bracket (A).
3. Insert the hex head bolts - one of which is shown at (C) - and flat washers, in the holes from the inside out.
4. Using an $\frac{1}{16}$ " open end wrench, tighten the locknuts - one of which is shown at (D) - on the hex head bolts. Hold the hex head bolts with an $\frac{1}{16}$ " socket as you tighten.

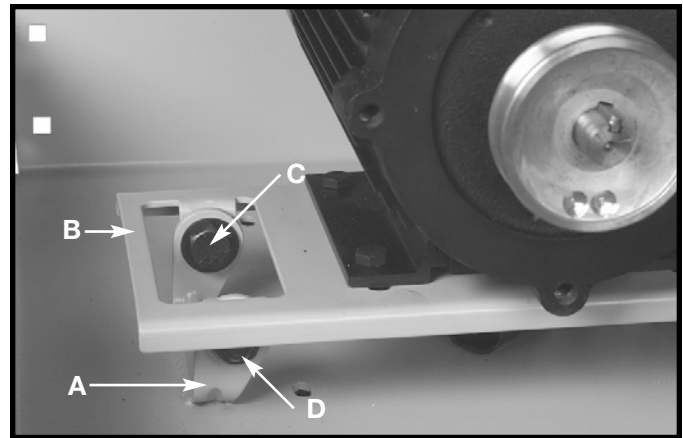

Fig. 7

ATTACHING MACHINE TO STAND

⚠ WARNING DISCONNECT MACHINE FROM POWER SOURCE.

1. Pull the belt (A) Fig. 8 down through the smaller rectangular hole (B) in the top shelf of the stand.
2. Fasten the machine to the top shelf with four $\frac{5}{16}$ " x $\frac{1}{2}$ " bolts and lockwashers (C) Fig. 8 (three of which are shown) and four #10-32 self-tapping screws and washers (D). (The motor was removed for easier viewing here.)

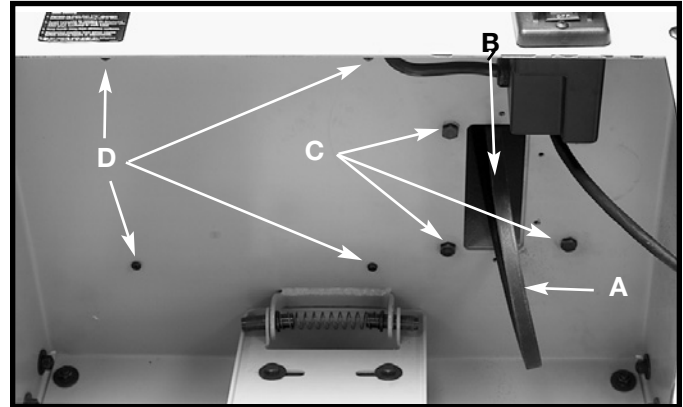

Fig. 8

INSTALLING DRIVE BELT AND BELT GUARD

⚠ WARNING DISCONNECT MACHINE FROM POWER SOURCE.

NOTE: MAKE SURE THE BELT IS ON THE SANDER DRIVE PULLEY.

1. Slip belt (A) Fig. 8A, over motor pulley (B).
2. Allow motor to drop and pull belt tight.
3. Be sure the pulleys are aligned properly. To adjust, loosen set screw (E) Fig. 8A with a $\frac{3}{16}$ hex wrench and move motor pulley to proper position. Once set, retighten set screw.
4. Other adjustments are possible. Loosen screws (D) and (C) Fig 8A and slide sanding unit right or left if needed. Retighten all hardware before continuing.
5. Insert carriage bolts (C) Fig. 8A from inside out to attach free end of motor to motor mounts.
6. Place washer and lockwasher on carriage bolts.
7. Thread wing nut (D) onto carriage bolts and tighten securely.
8. Place belt guard (F) Fig. 8B over pulley and belt. Align the holes in the guard (G) with the holes in the shelf (H). Fasten the guard to the shelf with four #10-32 machine screws.

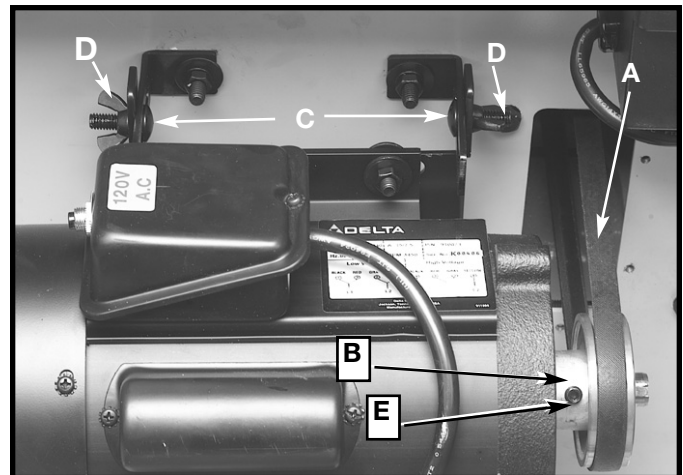

Fig. 8A

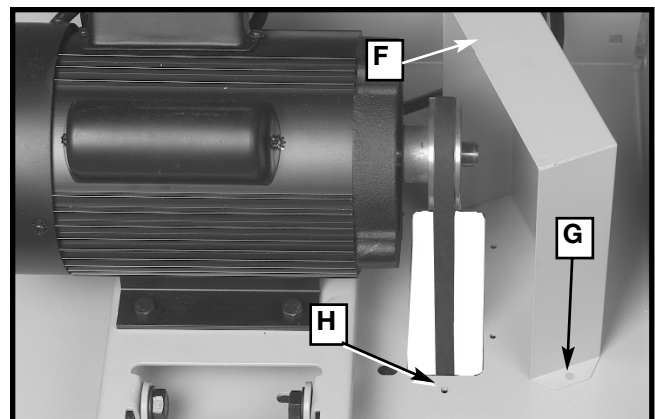

Fig. 8B

ATTACHING SANDING DISC

⚠ WARNING DISCONNECT MACHINE FROM POWER SOURCE.

1. Clean the sanding disc plate (A) Fig. 9 of any oil or grease, and be certain that it is dry.
2. Peel approximately 1/2 of the backing (B) Fig. 9 from the sanding disc (C).
3. Insert the sanding disc (C) Fig. 9 with the paper backing downward between the disc assembly and the disc guard.
4. Press the top half of the sanding disc firmly against the disc assembly (Fig. 10).
5. Manually rotate the disc assembly and remove the paper from the sanding disc (Fig. 11). Press the remaining half of the sanding disc firmly against the disc assembly.

IMPORTANT: Securely position the sanding disc on the disc assembly prior to applying power to the tool.

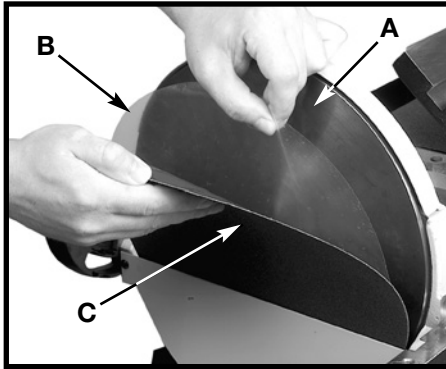

Fig. 9

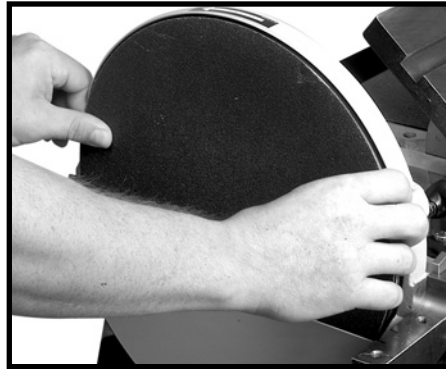

Fig. 10



Fig. 11

ATTACHING DISC TABLE

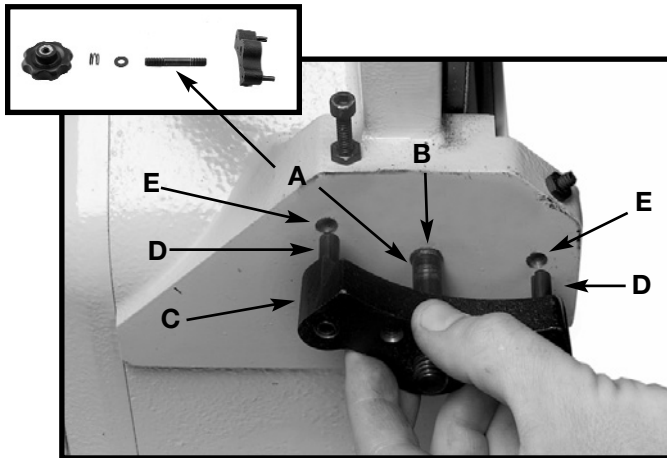

Fig. 12

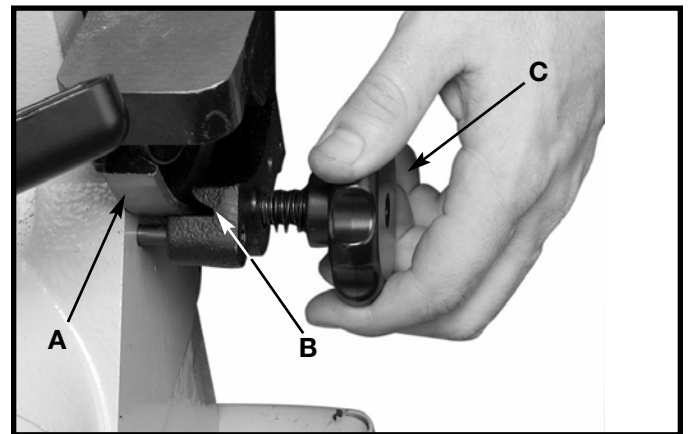

Fig. 13A

⚠ WARNING DISCONNECT MACHINE FROM POWER SOURCE.

1. Thread the disc table trunnion stud (A) Fig. 12 into the hole (B) on the side of the machine and tighten snug.
2. Place the disc table trunnion clamp (C) on the stud and insert the two pins (D) in the two holes (E).
3. Attach the washer, spring, and knob (Inset - Fig. 12)
4. Follow the same procedure for the other side.
5. Place the table in position. Confirm that the table trunnion (A) Fig. 13A rests in the groove (B) of the attaching clamps. Tighten the knob (C)
6. Remove the disc table trunnion knob (C) from the side of the machine where there is a scale on the trunnion. Attach the pointer (A) Fig. 13B to the hole (B) on the disc table trunnion clamp.
7. Tighten the knob (C) Fig. 13A.

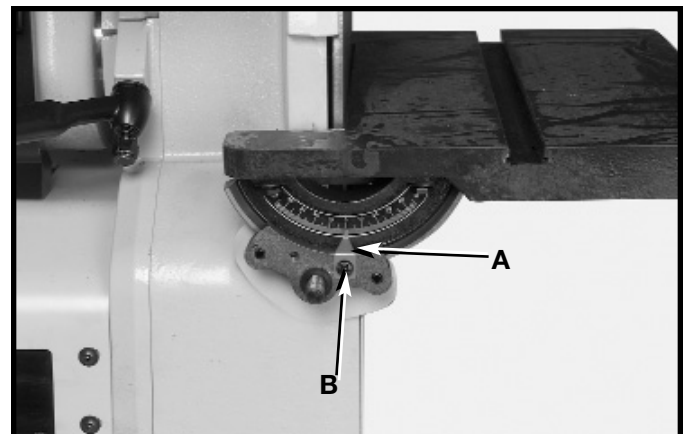

Fig. 13B

ATTACHING BELT TABLE

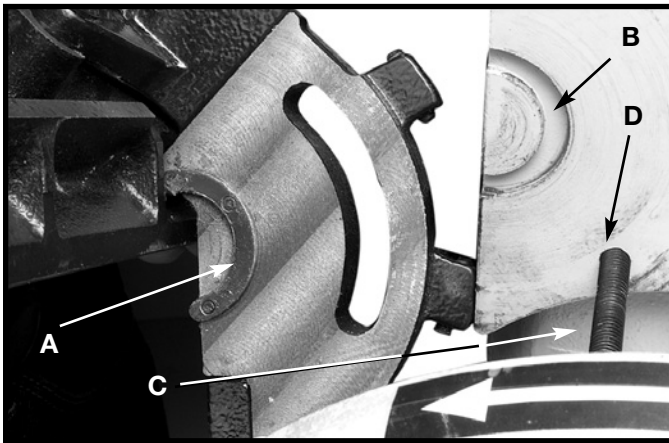

Fig. 14

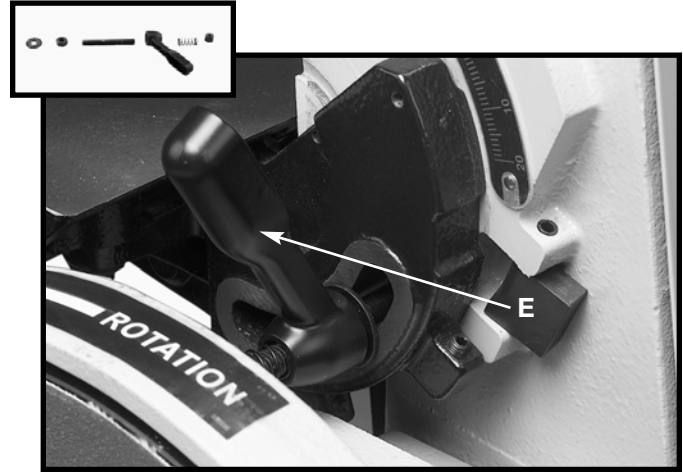

Fig. 15

⚠ WARNING DISCONNECT MACHINE FROM POWER SOURCE.

1. Insert the trunnion key (A) Fig. 14 into the slot on the side of the sanding arm (B).
2. Thread the stud (C) into the hole (D) on the side of the sanding arm.
3. Attach the washer, nut, lever, spring, and locknut (Inset - Fig 15)
4. Tighten the lever (E) Fig.15.

OPERATION

OPERATIONAL CONTROLS AND ADJUSTMENTS

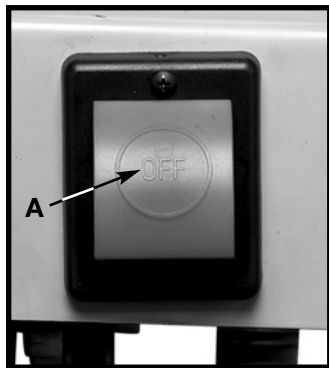

Fig. 16

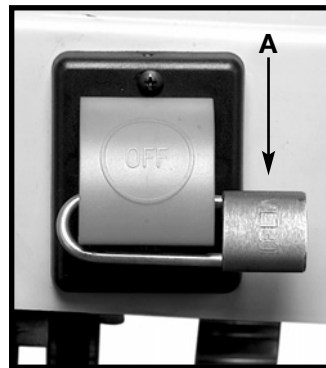

Fig. 17

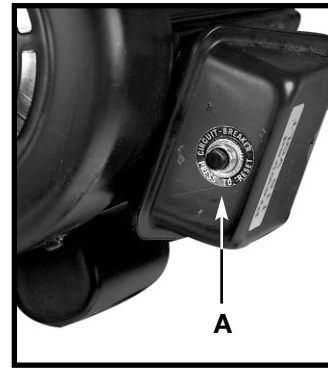

Fig. 18

STARTING AND STOPPING THE MACHINE

The on-off switch (A) Fig. 16 is located on the sander base. To turn the sander "ON", move the switch to the up position. To turn the sander "OFF", move the switch to the down position.

LOCKING SWITCH IN THE “OFF” POSITION

IMPORTANT: When the tool is not in use, the switch should be locked in the “OFF” position to prevent unauthorized use, using a padlock (A) Fig. 17 with a 3/16" diameter shackle.

OVERLOAD PROTECTION

The motor supplied with your sander is equipped with a reset overload relay button (A) Fig. 18. If the motor shuts off or fails to start because of overloading (sanding too heavy, using a worn sanding belt or disc, using the sander beyond its capacity), or low voltage, turn the switch (A) Fig. 16 to the “OFF” position. Let the motor cool three to five minutes and push the reset button (A) Fig. 18. Start the motor.

ADJUSTING TENSION AND TRACKING OF THE BELT

IMPORTANT: The machine is shipped without belt tension. Before operating the machine, follow these instructions for adjusting the belt for tension and tracking.

⚠ WARNING DISCONNECT MACHINE FROM POWER SOURCE.

1. Loosen the two lock knobs (A) Fig. 19, and remove the top cover (B).
2. Turn the belt tension lever (C) Fig. 20 counter-clockwise to increase the belt tension. **NOTE:** The tension lever (C) is spring-loaded and can be repositioned by pulling out the handle, moving it, and letting it spring back into position. Correct tension is determined by:
(A) flatness of the belt on the plate.
(B) slippage of the belt when sanding heavy work.
3. Rotate the belt (D) Fig. 21 by hand, and tighten or loosen the tracking knob (E) Figs. 20 and 21 until the belt is tracking correctly.
4. Turn the tool on and off to check for proper tracking. If the belt is leading to one side or the other, very gently turn the tracking knob (E) Fig. 20 clockwise to move the belt to the right or counterclockwise to move the belt to the left.
5. A final adjustment can be made with the motor running. **THIS ADJUSTMENT SHOULD BE VERY SLIGHT.**
6. Replace the top cover that was removed in **STEP 1**.

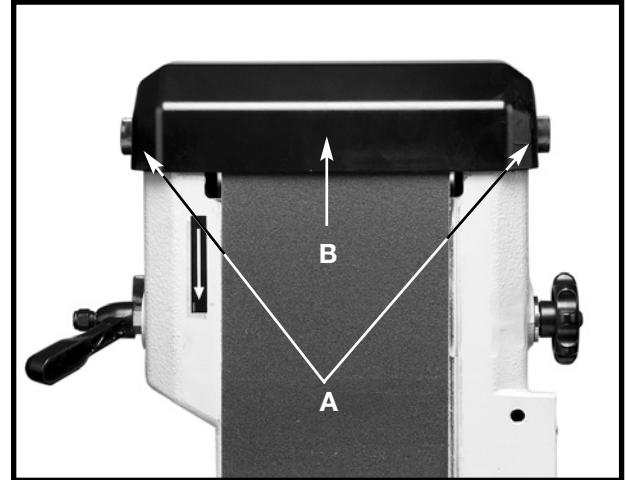

Fig. 19

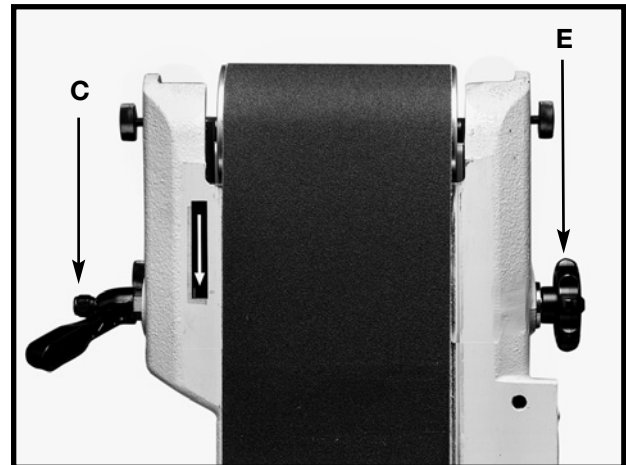

Fig. 20

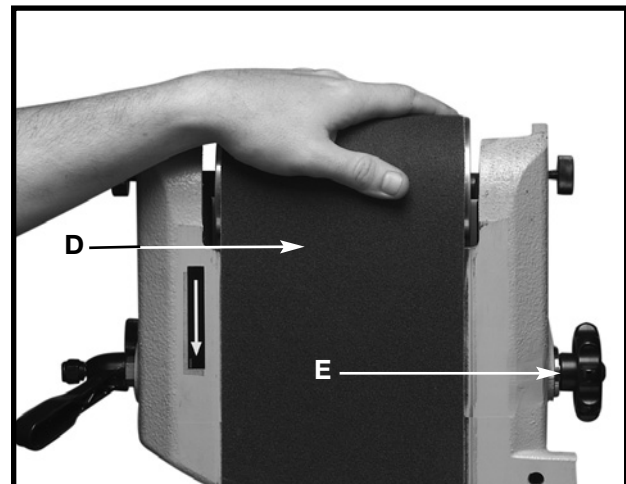

Fig. 21

NOTE: After a long period of time, adjustments may be necessary to maintain the tension and tracking of the sanding belt. If the belt will not hold its tension, tighten the set screw (G) Fig. 22. If the belt will not hold its tracking, tighten the set screw (F) Fig. 22.

Make only small adjustments to these screws. Over-tightening will lock the tension lever and/or the tracking knob.

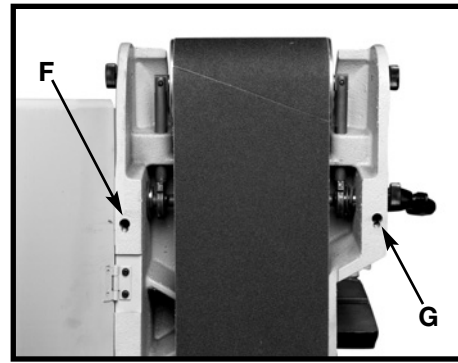

Fig. 22

ADJUSTING SANDING BELT TABLE 90 DEGREES TO BELT

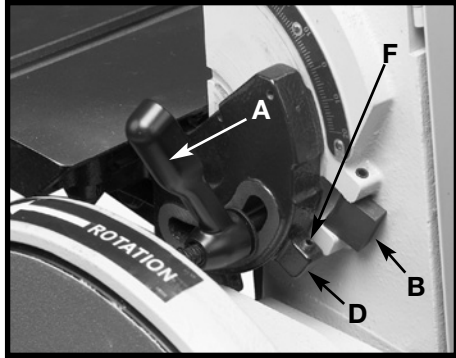

Fig. 23

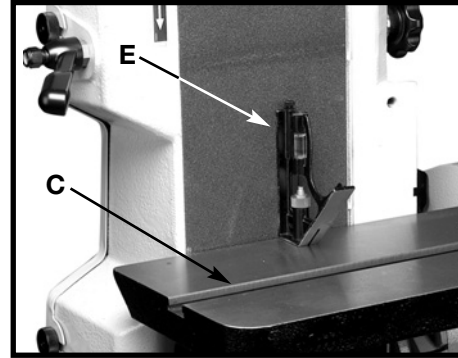

Fig. 24

⚠ WARNING DISCONNECT MACHINE FROM POWER SOURCE.

1. Loosen the table tilting lock handle (A) Fig. 23, move the stop (B) into position, and rotate the table (C) Fig. 24 until the trunnion (D) Fig. 23 contacts the stop (B). Tighten the lock handle (A). **NOTE:** The lock handle (A) is spring-loaded and can be repositioned by pulling out the handle, moving it, and letting it spring back into position.
2. Place a square (E) Fig. 24 on the table against the belt. See if the table is 90 degrees to the belt.
3. To adjust, loosen the table tilting lock handle (A) Fig. 23. Turn the adjusting screw (F) in or out until table is 90 degrees to the belt.
4. Tighten the lock handle (A) Fig. 23.
5. The adjusting screw (F) Fig. 23 ensures that the belt table can rapidly return to the 90 degree position after the table has been tilted.
6. Adjust the pointer, if necessary.

TILTING THE BELT SANDER TABLE

⚠ WARNING DISCONNECT MACHINE FROM POWER SOURCE.

The table (A) can be tilted 45 degrees down (Fig. 25). To tilt the table, loosen the lock handle (B), tilt the table to the desired angle, and tighten the lock handle (B). The degree of tilt is noted on the pointer and scale.

NOTE: When tilting the table down (Fig. 25), rotate the stop (E) Fig. 26 out of the way.

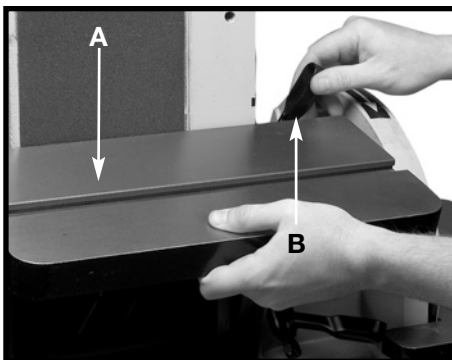

Fig. 25

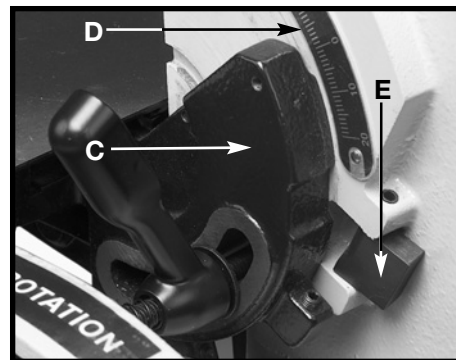

Fig. 26

ADJUSTING BELT SANDER TABLE MITER GAUGE SLOT PARALLEL TO SANDING BELT

⚠ WARNING DISCONNECT MACHINE FROM POWER SOURCE

1. Position the table (A) (Figs. 27 and 28) 90 degrees to the belt. Place a square (B) in the miter gauge slot with the blade (C) of the square touching the sanding belt. Check the opposite end of the belt to see if the miter gauge slot (D) is parallel to the belt.
2. To adjust, loosen the three (3) screws (E) Fig. 29, located underneath the table. Move the table (A) until the miter gauge slot is parallel to the sanding belt. Tighten the three (3) screws (E).

NOTE: When making this adjustment, tighten the table lock handle.

IMPORTANT: Maintain a maximum distance of 1/16" between the sanding belt and the table.

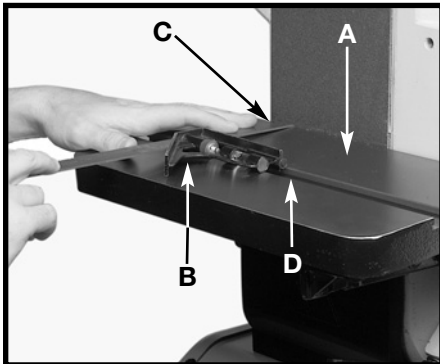

Fig. 27

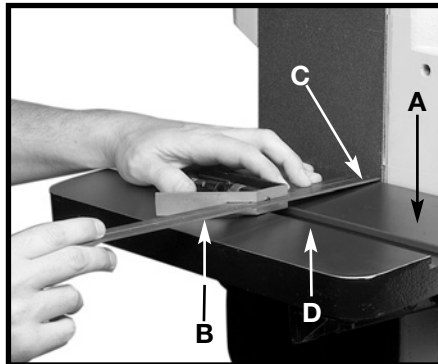

Fig. 28

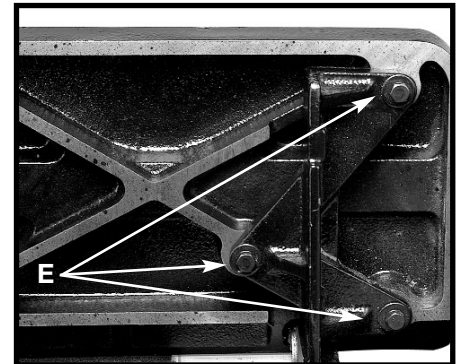

Fig. 29

CHANGING POSITION OF SANDING ARM

⚠ WARNING DISCONNECT MACHINE FROM POWER SOURCE.

1. The sanding arm (A) can be used in the vertical position (Fig. 31), the horizontal position (Fig. 30), or any angle in between. Loosen the lock handle (B), position the arm (A) to the desired angle, and tighten the lock handle (B).
2. The top idler pulley cover (C) Figs. 30 and 31 can be removed to clear the workpiece when sanding in the horizontal position. For a long workpiece, lower the deflector plate (D) to clear the workpiece. Raise the deflector plate (D) to deflect saw dust when sanding a short workpiece.

NOTE: With the sanding arm (A) in the horizontal position (Fig. 31), use the table (E) or the accessory backstop to support the work.

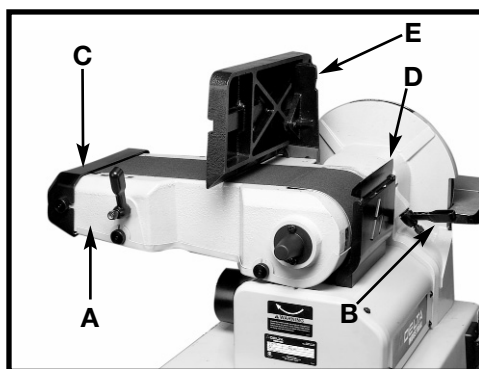

Fig. 30

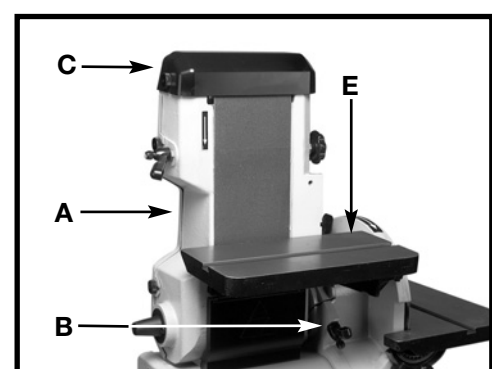

Fig. 31

ADJUSTING SANDING DISC TABLE 90 DEGREES TO DISC

⚠ WARNING DISCONNECT MACHINE FROM POWER SOURCE

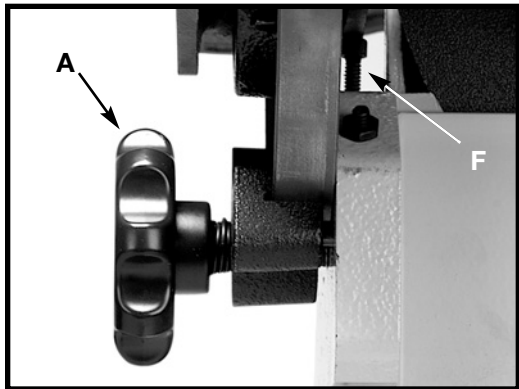

Fig. 32

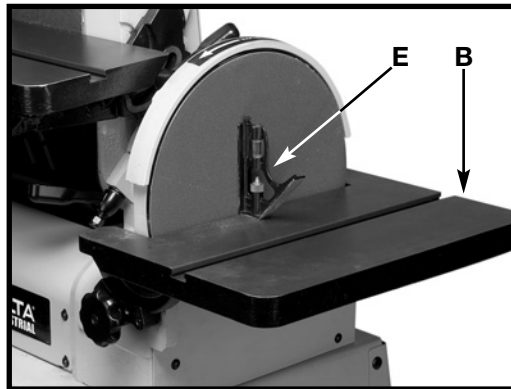

Fig. 33

1. Loosen the disc table lock handle (A) Fig. 32, and move the table (B) Fig. 33 until it contacts the stop. Tighten the lock handle (A) Fig. 32.
2. Place a square (E) Fig. 33 on the table and against the sanding disc. See if the table is 90 degrees to the disc.
3. To adjust, loosen the lock handle (A) Fig. 32, and tighten or loosen the screw (F) Fig. 32 until the table is 90 degrees to the disc.
4. The stop (F) Fig. 32 ensures that the table can rapidly return 90 degrees to the disc after the table has been tilted.
5. Adjust pointer, if necessary.

TILTING THE DISC SANDER TABLE

⚠ WARNING DISCONNECT MACHINE FROM POWER SOURCE.

The table (A) can be tilted 45 degrees down (Fig. 34), by loosening the lock handle (B), tilting the table (A), and tightening lock handle (B). The degree of tilt is determined by the scale and pointer.

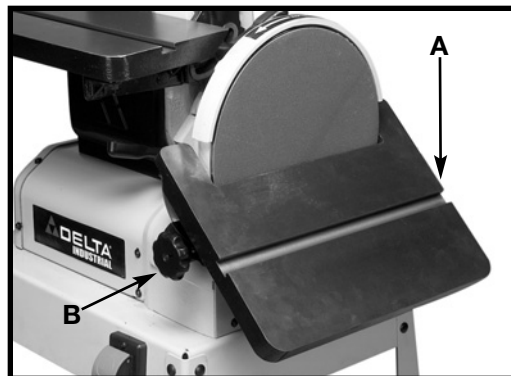

Fig. 34

ADJUSTING DISC TABLE MITER GAUGE SLOT PARALLEL TO SANDING DISC

⚠ WARNING DISCONNECT MACHINE FROM POWER SOURCE

1. With the table (A) Fig. 35 positioned 90 degrees to the disc, place a square (B) in the miter gauge slot with the blade of the square touching the sanding disc.
2. Use a pencil to mark the disc where the blade contacts it. (Fig. 35).
3. Rotate the disc to the other end of the table. Use a square to check the distance between the miter gauge slot and the mark on the disc made in **STEP 3**.

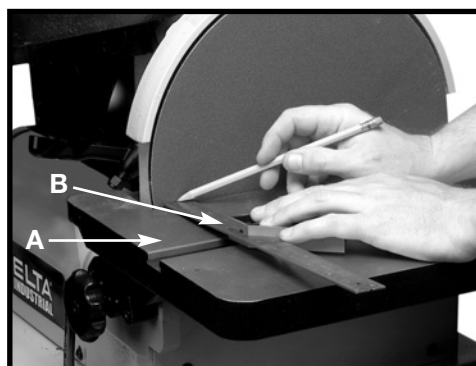

Fig. 35

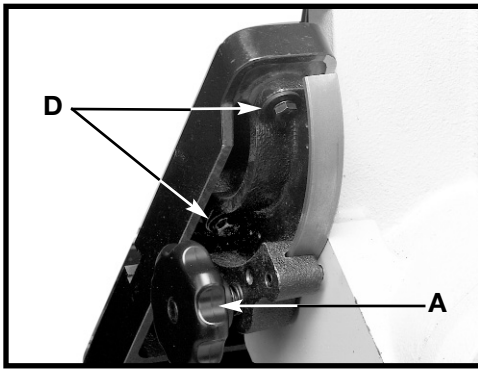

Fig. 36

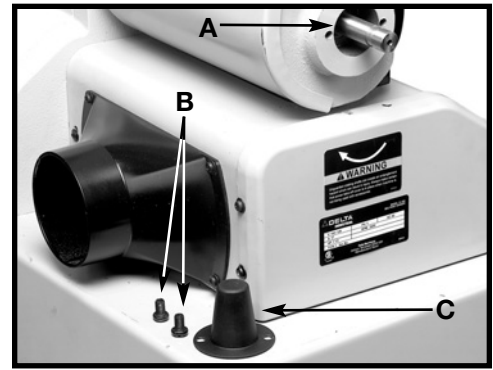

Fig. 37

- To adjust, loosen the four screws, two of which are shown at (D) Fig. 36. Adjust the table until the miter gauge slot is parallel to the disc. Tighten the four screws (D).

NOTE: When making this adjustment, tighten the lock handle (A) Fig. 36.

IMPORTANT: Maintain a maximum distance of 1/16" between the sanding disc and the table.

POWER TAKE-OFF SHAFT

⚠ WARNING DISCONNECT MACHINE FROM POWER SOURCE

- A power take-off shaft (A) Fig. 37 is provided on the lower end of the sanding belt arm to accommodate accessories.
- For access to the power take-off shaft, remove the two screws (B) Fig. 37, and cover (C).

⚠ WARNING Unguarded rotating shafts (A) Fig 37 can create an entanglement hazard. **ALWAYS COVER THE POWER TAKE-OFF SHAFT** when not using accessories.

REPLACING SANDING BELT

To replace the sanding belt:

⚠ WARNING DISCONNECT MACHINE FROM POWER SOURCE

- Loosen the two lock knobs (A) Fig. 38, and remove the top cover (B).
- Loosen the two screws (C) Fig. 39 enough to allow the back panel (D) Fig. 38 to hinge open. **NOTE:** The screw (C) cannot be removed.
- Release the belt tension by turning the hand lever (E) Fig. 38. Slide the belt (F) Fig. 40 off of both sanding drums.
- Slide the new sanding belt over both sanding drums. Ensure that the belt runs in the direction of the arrow, printed on the inside of the belt.
- Apply tension to the sanding belt and replace the top cover removed in **STEP 2**.
- Tighten the two screws loosened in **STEP 3**.
- Connect the power source to the sander and check for proper belt tracking.

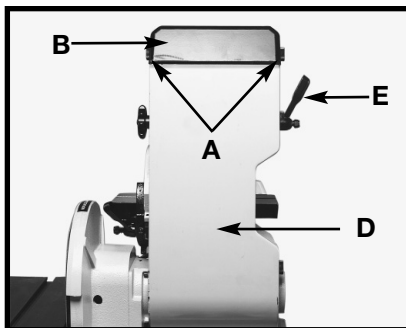

Fig. 38

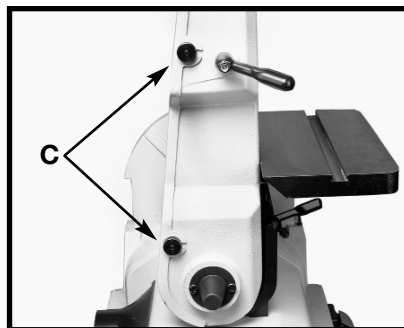

Fig. 39

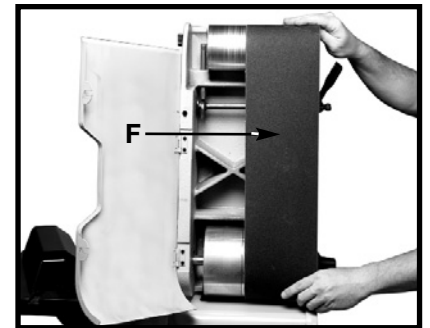

Fig. 40

REPLACING SANDING DISC

⚠ WARNING DISCONNECT MACHINE FROM POWER SOURCE.

See "ATTACHING SANDING DISC" section in this manual.

MACHINE USE

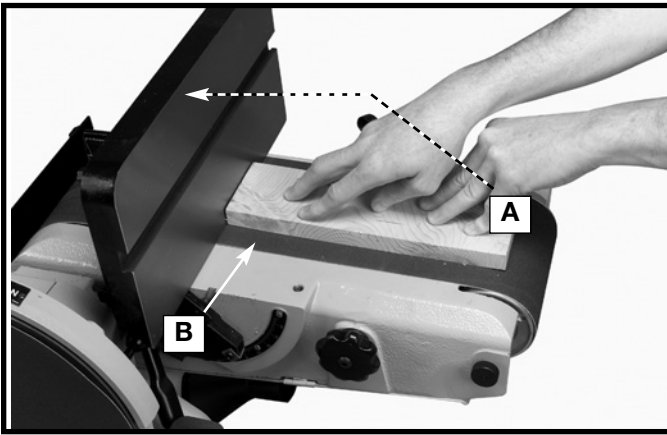

Fig. 44

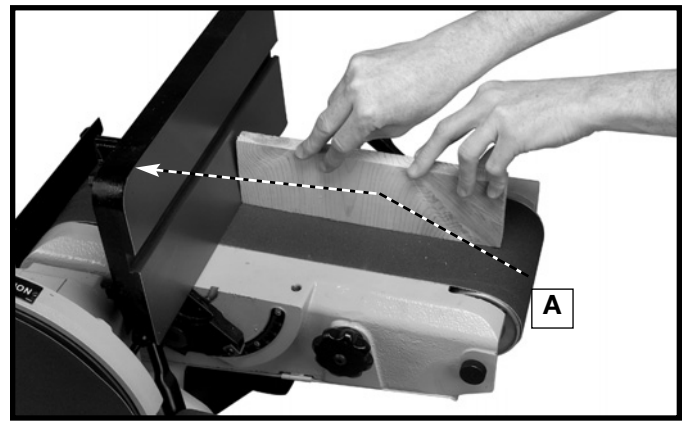

Fig. 45

SURFACING OR EDGE SANDING WITH SANDING BELT

When surfacing (Fig. 44) or edge sanding (Fig. 45), place the sanding arm in the horizontal position and use the table (A) Fig. 44 and Fig. 45 to keep the workpiece in place. Hold the workpiece firmly and keep your fingers away from the sanding belt. Place the end of the workpiece against the table and move the workpiece evenly across the sanding belt. Apply only enough pressure to allow the sanding belt to remove material. Use extra caution when sanding very thin pieces.

⚠ WARNING POSITION THE EDGE OF THE TABLE (A) FIG. 44 A MAXIMUM OF 1/16" AWAY FROM THE SANDING BELT (B) TO AVOID TRAPPING THE WORKPIECE OR YOUR FINGERS BETWEEN THE TABLE AND THE SANDING BELT.

SANDING INSIDE CURVES

You can sand inside curves on the top sanding drum (Fig. 46) if you loosen the knobs (A) Fig. 46 inset and remove the guard

⚠ CAUTION REPLACE THE SANDING DRUM GUARD AFTER THE SANDING OPERATION IS COMPLETED.

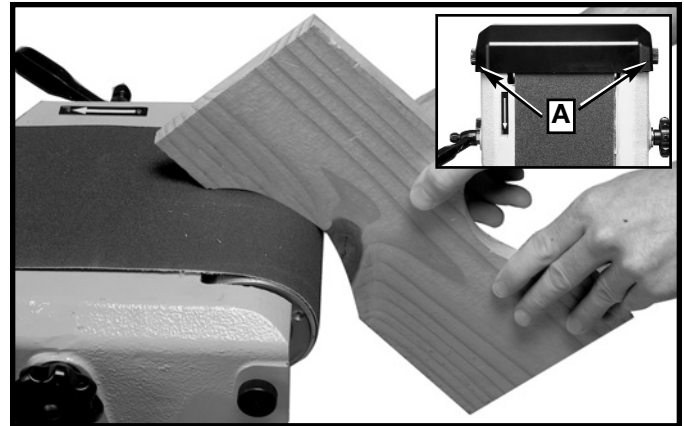

Fig. 46

SANDING OUTSIDE CURVES

Sand outside curves on the sanding disc as illustrated in Fig. 47.

⚠ WARNING ALWAYS SAND ON THE LEFT SIDE (DOWNWARD ROTATION SIDE) OF THE SANDING DISC. SANDING ON THE RIGHT SIDE (UPWARD ROTATION SIDE) OF THE SANDING DISC COULD CAUSE THE WORKPIECE TO FLY UP, WHICH COULD BE HAZARDOUS.

⚠ WARNING THE EDGE OF THE TABLE (A) FIG. 47 MUST BE POSITIONED A MAXIMUM OF 1/16" AWAY FROM THE SANDING DISC (B) TO AVOID TRAPPING THE WORKPIECE OR FINGERS BETWEEN THE TABLE AND SANDING DISC.

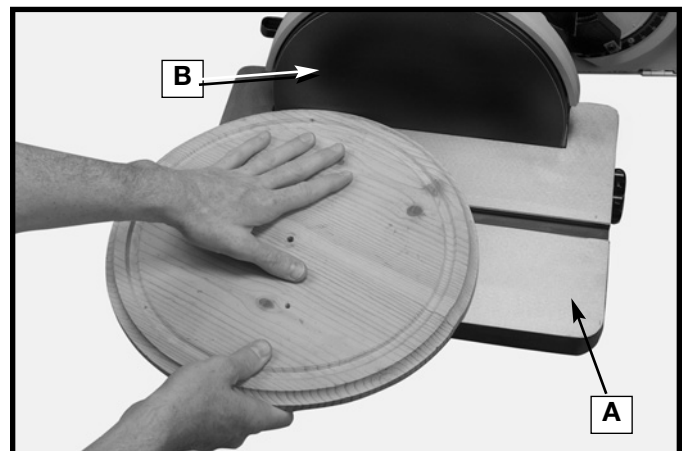

Fig. 47

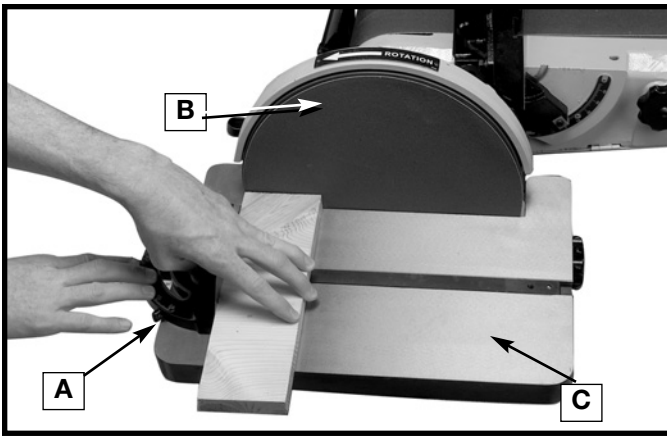

Fig. 48



Fig. 49

END SANDING WITH THE DISC

When sanding the ends of narrow workpieces, use the sanding disc and an accessory miter gauge (A) Fig. 48. Move the work from the center to the left side (downward) of the sanding disc.

⚠ WARNING ALWAYS SAND ON THE LEFT SIDE (DOWNWARD ROTATION SIDE) OF THE SANDING DISC. SANDING ON THE RIGHT SIDE (UPWARD ROTATION SIDE) OF THE SANDING DISC COULD CAUSE THE WORKPIECE TO FLY UP, WHICH COULD BE HAZARDOUS.

⚠ WARNING THE EDGE OF THE TABLE (C) FIG. 48 MUST BE POSITIONED A MAXIMUM OF 1/16" AWAY FROM THE SANDING DISC (B) TO AVOID TRAPPING THE WORK OR FINGERS BETWEEN THE TABLE AND THE SANDING DISC.

END SANDING WIDE WORKPIECES WITH THE BELT

When sanding the ends of wide workpieces, use the sanding arm in the vertical position (Fig. 49).

For more accurate work use an accessory miter gauge and move the work evenly across the sanding belt (Fig. 49).

TROUBLESHOOTING

For assistance with your machine, visit our website at www.deltamachinery.com for a list of service centers or call the DELTA Machinery help line at 1-800-223-7278 (In Canada call 1-800-463-3582).

MAINTENANCE

KEEP MACHINE CLEAN

Periodically blow out all air passages with dry compressed air. All plastic parts should be cleaned with a soft damp cloth. NEVER use solvents to clean plastic parts. They could possibly dissolve or otherwise damage the material.

▲ WARNING Wear ANSI Z87.1 safety glasses while using compressed air.

FAILURE TO START

Should your machine fail to start, check to make sure the prongs on the cord plug are making good contact in the outlet. Also, check for blown fuses or open circuit breakers in the line.

LUBRICATION

Apply household floor paste wax to the machine table and extension table or other work surface weekly.

PROTECTING CAST IRON FROM RUST

To clean and protect cast iron tables from rust, you will need the following materials: 1 pushblock from a jointer, 1 sheet of medium Scotch-Brite™ Blending Hand Pad, 1 can of WD-40®, 1 can of degreaser, 1 can of TopCote® Aerosol. Apply the WD-40 and polish the table surface with the Scotch-Brite pad using the pushblock as a holddown. Degrease the table, then apply the TopCote® accordingly.

SERVICE



PARTS, SERVICE OR WARRANTY ASSISTANCE

All Delta Machines and accessories are manufactured to high quality standards and are serviced by a network of Porter-Cable • Delta Factory Service Centers and Delta Authorized Service Stations. To obtain additional information regarding your Delta quality product or to obtain parts, service, warranty assistance, or the location of the nearest service outlet, please call 1-800-223-7278 (In Canada call 1-800-463-3582).

ACCESSORIES

A complete line of accessories is available from your Delta Supplier, Porter-Cable • Delta Factory Service Centers, and Delta Authorized Service Stations. Please visit our Web Site www.deltamachinery.com for a catalog or for the name of your nearest supplier.

▲WARNING Since accessories other than those offered by Delta have not been tested with this product, use of such accessories could be hazardous. For safest operation, only Delta recommended accessories should be used with this product.

WARRANTY



Two Year Limited New Product Warranty

Delta will repair or replace, at its expense and at its option, any new Delta machine, machine part, or machine accessory which in normal use has proven to be defective in workmanship or material, provided that the customer returns the product prepaid to a Delta factory service center or authorized service station with proof of purchase of the product within two years and provides Delta with reasonable opportunity to verify the alleged defect by inspection. For all refurbished Delta product, the warranty period is 180 days. Delta may require that electric motors be returned prepaid to a motor manufacturer's authorized station for inspection and repair or replacement. Delta will not be responsible for any asserted defect which has resulted from normal wear, misuse, abuse or repair or alteration made or specifically authorized by anyone other than an authorized Delta service facility or representative. Under no circumstances will Delta be liable for incidental or consequential damages resulting from defective products. This warranty is Delta's sole warranty and sets forth the customer's exclusive remedy, with respect to defective products; all other warranties, express or implied, whether of merchantability, fitness for purpose, or otherwise, are expressly disclaimed by Delta.

NOTES

NOTES

PORTER-CABLE • DELTA SERVICE CENTERS (CENTROS DE SERVICIO DE PORTER-CABLE • DELTA)

Parts and Repair Service for Porter-Cable • Delta Machinery are Available at These Locations
(Obtenga Refaccion de Partes o Servicio para su Herramienta en los Siguietes Centros de Porter-Cable • Delta)

ARIZONA

Phoenix 85013-2906
4501 N. 7th Ave.
Phone: (602) 279-6414
Fax: (602) 279-5470

CALIFORNIA

Ontario 91761 (Los Angeles)
3949A East Guasti Road
Phone: (909) 390-5555
Fax: (909) 390-5554

San Diego 92111
7290 Clairemont Mesa Blvd.
Phone: (858) 279-2011
Fax: (858) 279-0362

San Leandro 94577 (Oakland)
3039 Teagarden Street
Phone: (510) 357-9762
Fax: (510) 357-7939

COLORADO

Denver 80223
700 West Mississippi Ave.
Phone: (303) 922-8325
Fax: (303) 922-0245

FLORIDA

Davie 33314 (Miami)
4343 South State Rd. 7 (441)
Unit #107
Phone: (954) 321-6635
Fax: (954) 321-6638

Tampa 33634
4909 West Waters Ave.
Phone: (813) 884-0434
Fax: (813) 888-5997

GEORGIA

Forest Park 30297 (Atlanta)
5442 Frontage Road,
Suite 112
Phone: (404) 608-0006
Fax: (404) 608-1123

ILLINOIS

Addison 60101 (Chicago)
400 South Rohlwing Rd.
Phone: (630) 424-8805
Fax: (630) 424-8895

Woodridge 60517 (Chicago)
2033 West 75th Street
Phone: (630) 910-9200
Fax: (630) 910-0360

KANSAS

Overland Park 66214
9201 Quivira Road
Phone: (913) 495-4330
Fax: (913) 495-4378

MARYLAND

Elkridge 21075 (Baltimore)
7397-102 Washington Blvd.
Phone: (410) 799-9394
Fax: (410) 799-9398

MASSACHUSETTS

Franklin 02038 (Boston)
Franklin Industrial Park
101E Constitution Blvd.
Phone: (508) 520-8802
Fax: (508) 528-8089

MICHIGAN

Madison Heights 48071 (Detroit)
30475 Stephenson Highway
Phone: (248) 597-5000
Fax: (248) 597-5004

MINNESOTA

Eden Prairie 55344
9709 Valley View Road
Phone: (952) 884-9191
Fax: (952) 884-3750

MISSOURI

St. Louis 63146
11477 Page Service Drive
Phone: (314) 997-9100
Fax: (314) 997-9183

NEW YORK

Flushing 11365-1595 (N.Y.C.)
175-25 Horace Harding Expwy.
Phone: (718) 225-2040
Fax: (718) 423-9619

NORTH CAROLINA

Charlotte 28270
9129 Monroe Road, Suite 115
Phone: (704) 841-1176
Fax: (704) 708-4625

OHIO

Columbus 43229
1948 Schrock Road
Phone: (614) 895-3112
Fax: (614) 895-3187

Cleveland 44125
8001 Sweet Valley Drive Unit #19
Phone: (216) 447-9030
Fax: (216) 447-3097

OREGON

Portland 97230
14811 North East Airport Way
Phone: (503) 255-6556
Fax: (503) 255-6543

PENNSYLVANIA

Willow Grove 19090
(Philadelphia)
520 North York Road
Phone: (215) 658-1430
Fax: (215) 658-1433

TEXAS

Carrollton 75006 (Dallas)
1300 Interstate 35 N, Suite 112
Phone: (972) 446-2996
Fax: (972) 446-8157

Houston 77022-2122
536 East Tidwell Rd.
Phone: (713) 692-7111
Fax: (713) 692-1107

WASHINGTON

Auburn 98001 (Seattle)
3320 West Valley HWY, North
Building D, Suite 111
Phone: (253) 333-8353
Fax: (253) 333-9613

Authorized Service Stations are located in many large cities. Telephone **800-438-2486** or **731-541-6042** for assistance locating one. Parts and accessories for Porter-Cable-Delta products should be obtained by contacting any Porter-Cable-Delta Distributor, Authorized Service Center, or Porter-Cable-Delta Factory Service Center. If you do not have access to any of these, call **800-223-7278** and you will be directed to the nearest Porter-Cable-Delta Factory Service Center. Las Estaciones de Servicio Autorizadas están ubicadas en muchas grandes ciudades. Llame al **800-438-2486** ó al **731-541-6042** para obtener asistencia a fin de localizar una. Las piezas y los accesorios para los productos Porter-Cable-Delta deben obtenerse poniéndose en contacto con cualquier distribuidor Porter-Cable-Delta, Centro de Servicio Autorizado o Centro de Servicio de Fábrica Porter-Cable-Delta. Si no tiene acceso a ninguna de estas opciones, llame al **800-223-7278** y le dirigirán al Centro de Servicio de Fábrica Porter-Cable-Delta más cercano.

CANADIAN PORTER-CABLE • DELTA SERVICE CENTERS

ALBERTA

Bay 6, 2520-23rd St. N.E.
Calgary, Alberta
T2E 8L2
Phone: (403) 735-6166
Fax: (403) 735-6144

BRITISH COLUMBIA

8520 Baxter Place
Burnaby, B.C.
V5A 4T8
Phone: (604) 420-0102
Fax: (604) 420-3522

MANITOBA

1699 Dublin Avenue
Winnipeg, Manitoba
R3H 0H2
Phone: (204) 633-9259
Fax: (204) 632-1976

ONTARIO

505 Southgate Drive
Guelph, Ontario
N1H 6M7
Phone: (519) 767-4132
Fax: (519) 767-4131

QUÉBEC

1515 ave.
St-Jean Baptiste, Suite 160
Québec, Québec
G2E 5E2
Phone: (418) 877-7112
Fax: (418) 877-7123

1447, Begin
St-Laurent, (Montréal),
Québec
H4R 1V8
Phone: (514) 336-8772
Fax: (514) 336-3505

The following are trademarks of PORTER-CABLE • DELTA (Las siguientes son marcas registradas de PORTER-CABLE • DELTA S.A.) (Les marques suivantes sont des marques de fabricant de la PORTER-CABLE • DELTA): Auto-Set®, BAMMER®, B.O.S.S.®, Builder's Saw®, Contractor's Saw®, Contractor's Saw II™, Delta®, DELTACRAFT®, DELTAGRAM™, Delta Series 2000™, DURATRONIC™, Emc²™, FLEX®, Flying Chips™, FRAME SAW®, Grip Vac™, Homecraft®, INNOVATION THAT WORKS®, Jet-Lock®, JETSTREAM®, 'kickstand®, LASERLOC®, MICRO-SET®, Micro-Set®, MIDI LATHE®, MORTEN™, NETWORK™, OMNIJIG®, POCKET CUTTER®, PORTA-BAND®, PORTA-PLANE®, PORTER-CABLE®&(design), PORTER-CABLE®PROFESSIONAL POWER TOOLS, PORTER-CABLE REDEFINING PERFORMANCE™, Posi-Matic®, Q-3®&(design), QUICKSAND®&(design), QUICKSET™, QUICKSET II®, QUICKSET PLUS™, RIPTIDE™&(design), SAFE GUARD II®, SAFE-LOC®, Sanding Center®, SANDTRAP®&(design), SAW BOSS®, Sawbuck™, Sidekick®, SPEED-BLOC®, SPEEDMATIC®, SPEEDTRONIC®, STAIR EASE®, The American Woodshop®&(design), The Lumber Company®&(design), THE PROFESSIONAL EDGE®, THE PROFESSIONAL SELECT®, THIN-LINE™, TIGER®, TIGER CUB®, TIGER SAW®, TORQBUSTER®, TORQ-BUSTER®, TRU-MATCH™, TWIN-LITE®, UNIGUARD®, Unifence®, UNIFEEDER™, Unihead®, Uniplane™, Unirip®, Unisaw®, Univise®, Versa-Feeder®, VERSA-PLANE®, WHISPER SERIES®, WOODWORKER'S CHOICE™.

Trademarks noted with ™ and ® are registered in the United States Patent and Trademark Office and may also be registered in other countries. Las Marcas Registradas con el signo de ™ y ® son registradas por la Oficina de Registros y Patentes de los Estados Unidos y también pueden estar registradas en otros países.