

Operating Instructions

AAC WMA MP3 CD Player/Receiver

 Model: **CQ-RX400U**

WMA MP3 CD Player/Receiver

 Model: **CQ-RX200U/CQ-RX100U/
CQ-RX100L**







(CQ-RX400U)



AAC WMA MP3



(CQ-RX400U)





- Please read these instructions (including "Limited Warranty" and "Customer Services Directory") carefully before using this product and keep this manual for future reference.

Accessories

Instruction kit	Q'ty
CQ-RX400U CQ-RX200U CQ-RX100U  Operating Instructions (English: YGFM286048) (Français: YGFM286049) (Español: YGFM286050)	1 set
 CQ-RX400U CQ-RX200U System Upgrade Guidebook (YGFM262850)	1
 Installation Instructions (YGFM294416)	1
 Product Registration Card	1
 Customer Care Plan	1

Instruction kit	Q'ty
CQ-RX100L  Operating Instructions (English: YGFM286048) (Español: YGFM286050)	1 set
 Installation Instructions (YGFM294416)	1

Installation kit	Q'ty
 Lock Cancel Plate	1 set
 Mounting Bolt (5 mm φ)	
 Rubber Bushing	

	Q'ty
 Mounting Collar (YEFX0217263A)	1
 Trim Plate (YGFC051023)	1
 Power Connector (K1HY12YY0003)	1
 Remote Control Unit (includes a battery) (EUR7641010)	1
 CQ-RX400U CQ-RX100L Removable Face Plate Case (YGFA134302)	1

Notes:

- The number in parentheses underneath each accessory part name is the part number for maintenance and service.
- Accessories and their part numbers are subject to modification without prior notice due to improvements.
- Mounting Collar and Trim Plate are mounted on the main unit at shipment.

CQ-RX200U CQ-RX100U

Request for use of the Removable Face Plate Case:

- To avoid trouble and ensure safety, use the optional Removable Face Plate Case (YGFA134302).

Safety Information

- Read the operating instructions for the unit and all other components of your car audio system carefully before using the system. They contain instructions about how to use the system in a safe and effective manner. Panasonic assumes no responsibility for any problems resulting from failure to observe the instructions given in this manual.



Warning

This pictograph intends to alert you to the presence of important operating instructions and installation instructions. Failure to heed the instructions may result in severe injury or death.



Caution

This pictograph intends to alert you to the presence of important operating instructions and installation instructions. Failure to heed the instructions may result in injury or material damage.

Warning

Observe the following warnings when using this unit.

- ❑ **The driver should neither watch the display nor operate the system while driving.**

Watching the display or operating the system will distract the driver from looking ahead of the vehicle and can cause accidents. Always stop the vehicle in a safe location and use the parking brake before watching the display or operating the system.

- ❑ **Use the proper power supply.**

This product is designed for operation with a negative grounded 12 V DC battery system. Never operate this product with other battery systems, especially a 24 V DC battery system.

- ❑ **Keep batteries and insulation film out of reach of infants.**

Batteries and insulation film can be ingested, so keep them out of the reach of infants. If an infant ingests a battery or insulation film, please seek immediate medical attention.

- ❑ **Protect the Deck Mechanism.**

Do not insert any foreign objects into the slot of this unit.

- ❑ **Do not disassemble or modify the unit.**

Do not disassemble, modify the unit or attempt to repair the product yourself. If the product needs to be repaired, consult your dealer or an authorized Panasonic Servicenter.

- ❑ **Do not use the unit when it is out of order.**

If the unit is out of order (no power, no sound) or in an abnormal state (has foreign objects in it, is exposed to water, is smoking, or smells), turn it off immediately and consult your dealer.

- ❑ **The remote control unit should not lie about in the car.**

If the remote control unit lies about, it could fall on the floor while driving, get wedged under the brake pedal, and lead to a traffic accident.

- ❑ **Refer fuse replacement to qualified service personnel.**

When the fuse blows out, eliminate the cause and have it replaced with the fuse prescribed for this unit by a qualified service engineer. Incorrect replacement of the fuse may lead to smoke, fire, and damage to the product.

Observe the following warnings when installing.

- ❑ **Disconnect the lead from the negative (-) battery terminal before installation.**

Wiring and installation with the negative (-) battery terminal connected may cause electrical shock and injury due to a short circuit. Some cars equipped with the electrical safety system have specific procedures of battery terminal disconnection.

FAILURE TO FOLLOW THE PROCEDURE MAY LEAD TO THE UNINTENDED ACTIVATION OF THE ELECTRICAL SAFETY SYSTEM RESULTING IN DAMAGE TO THE VEHICLE AND PERSONAL INJURY OR DEATH.

- ❑ **Never use safety-related components for installation, grounding, and other such functions.**

Do not use safety-related vehicle components (fuel tank, brake, suspension, steering wheel, pedals, airbag, etc.) for wiring or fixing the product or its accessories.

- ❑ **Installing the product on the air bag cover or in a location where it interferes with airbag operation is prohibited.**

- ❑ **Check for piping, gasoline tank, electric wiring, and other items before installing the product.**

If you need to open a hole in the vehicle chassis to attach or wire the product, first check where the wire harness, gasoline tank, and electric wiring are located. Then open the hole from outside if possible.

- ❑ **Never install the product in a location where it interferes with your field of vision.**

- ❑ **Never have the power cord branched to supply other equipment with power.**

- ❑ **After installation and wiring, you should check the normal operation of other electrical equipment.**

The continuation of their using in abnormal conditions may cause fire, electrical shock or a traffic accident.

- ❑ **In the case of installation to an airbag-equipping car, confirm warnings and cautions of the vehicle manufacturer before installation.**

- ❑ **Make sure the leads do not interfere with driving or getting in and out of the vehicle.**

- ❑ **Insulate all exposed wires to prevent short circuiting.**

Features

SQ (Sound Quality)

You have 6 preset modes (FLAT, ROCK, POP, VOCAL, JAZZ, CLUB). You can customize your settings for these and save them for instant recall.

SQ3 (3-Band Sound Quality)

Center frequency and level are adjustable in each of 3 bands. This lets you fine-tune sound quality for each genre to suit car-interior acoustics and your personal preferences. (→ "Sound Control")

USB Connector

CQ-RX400U

The USB Connector is equipped on the front panel.

(→ System Upgrade Guidebook)

By connecting a USB memory (not included) to USB connector via a USB extension cable (USB 2.0, not included), you can enjoy MP3/WMA/AAC files stored on the USB memory (not included) in your car.

By connecting iPod series to USB connector via a USB extension cable for iPod (USB 2.0, not included), you can enjoy music files stored on the iPod series in your car.

AUX (AUX1) Input Terminal

The AUX input terminal is equipped on the front panel.

Your mobile audio player and other devices are connectable to this unit without any difficulty.

Expansion Module (Hub Unit)

CQ-RX400U CQ-RX200U

Connection of the Expansion Module (hub unit, CY-EM100U) allows users to connect up to 4 optional devices shown below.

Wide Array of Components for System Upgrade

CQ-RX400U CQ-RX200U

Various optional components allow users to obtain availability of wide range of system upgrade. Upgrading the system delivers relaxed AV space in a car. For further information, refer to the separate **System Upgrade Guidebook**.

• iPod®

The optional adaptor (Direct Cable for iPod®: CA-DC300U) allows you to connect the optional iPod series.

iPod is a trademark of Apple Inc., registered in the U.S. and other countries.

• CD Changer

The optional adaptor (Conversion Cable for DVD/CD Changer: CA-CC30U) allows you to connect the optional Panasonic CD changer unit (CX-DP880U).

• XM Satellite Radio

You can connect the optional XM receiver (XMD1000) with optional Digital Adaptor Cable (XMDPAN110).

You can connect the optional XM Direct² (CNP2000UC) with optional Connection Cable (CNPPAN1).

For details, refer to the operating instructions for the XM receiver.

• Sirius Satellite Radio

You can connect the optional Sirius Satellite Radio receiver (SC-C1) with optional Interface Adaptor (CA-LSR01U).

Note: The optional Sirius Satellite Radio receiver SIR-PAN1/the optional Interface Adaptor CA-PANSC1U cannot be used with this unit.

• Bluetooth®

Using the optional Bluetooth® Unit (CY-BT200U) and a Bluetooth® device enables hands-free telephony and Bluetooth® Audio listening with this unit.

Note: This unit does not support CY-BT100U.

Bluetooth®

The Bluetooth word mark and logo are owned by the Bluetooth SIG, Inc. and any use of such marks by Matsushita Electric Industrial Co., Ltd. is under license. Other trademarks and trade name are those of their respective owners.

Before Reading These Instructions

Panasonic welcomes you to our constantly growing family of electronic products owners. We endeavor to give you the advantages of precise electronic and mechanical engineering, manufactured with carefully selected components, and assembled by people who are proud of the reputation their work has built for our company. We know this product will bring you many hours of enjoyment, and after you discover the quality, value and reliability we have built into it, you too will be proud to be a member of our family.

CQ-RX400U CQ-RX200U

The instruction manual consists of 2 books. One is "Operating Instructions" describing the operations of the main unit. The other is "System Upgrade Guidebook" describing the optional devices such as CD changer.

Differences Among 4 Models

This operating instruction manual is for 4 models CQ-RX400U, CQ-RX200U, CQ-RX100U and CQ-RX100L. All illustrations throughout this manual represent model CQ-RX400U unless otherwise specified. The following table describes the differences among 4 models.

Features	Models	CQ-RX400U	CQ-RX200U	CQ-RX100U	CQ-RX100L
Removable Face Plate Case		Included	Not included	Not included	Included
System Upgrade Guidebook		Included	Included	Not included	Not included
System-up Connector		Supported	Supported	Not Supported	Not Supported
Preamp Out Connector		2 (Front/Rear)	1 (Rear)	1 (Rear)	1 (Rear)
USB Connector		Supported (USB iPod)	Not Supported	Not Supported	Not Supported
AAC playback		Supported	Not Supported	Not Supported	Not Supported
Button Logo Color		Blue	Blue	Blue	Red

U.S.A.

Obtain Product Information and Operating Assistance; locate your nearest Dealer or Servicenter; purchase Parts and Accessories; or make Customer Service and Literature requests by visiting our Web Site at:

<http://www.panasonic.com/support>

or, contact us via the web at:

<http://www.panasonic.com/contactinfo>

You may also contact us directly at:

1-800-211-PANA (7262),

Monday-Friday 9 am-9 pm; Saturday-Sunday 10 am-7 pm, EST.

For hearing or speech impaired TTY users, TTY : 1-877-833-8855

Accessory Purchases:

Purchase Parts, Accessories and Instruction Books online for all Panasonic Products by visiting our Web Site at:

<http://www.pasc.panasonic.com>

or, send your request by E-mail to:

npcparts@panasonic.com

You may also contact us directly at:

1-800-332-5368 (Phone) 1-800-237-9080 (Fax Only)

(Monday-Friday 9 am to 8 pm, EST.)

Panasonic Services Company

20421 84th Avenue South, Kent, WA 98032

(We accept Visa, MasterCard, Discover Card, American Express, and Personal Checks)

For hearing or speech impaired TTY users, TTY : 1-866-605-1277

Service in Puerto Rico

Panasonic Puerto Rico, Inc.

Panasonic Sales Company

Factory Servicenter:

Ave. 65 de Infanteria, Km. 9.5, San Gabriel Industrial Park, Carolina, Puerto Rico 00985

Phone (787) 750-4300, Fax (787) 768-2910

CANADA

WARRANTY SERVICE

FOR PRODUCT OPERATION ASSISTANCE, please contact:

Our Customer Care Centre:

Telephone #: (905) 624-5505

1-800 #: 1-800-561-5505

Fax #: (905) 238-2360

Email link: "Contact Us" on www.panasonic.ca

FOR PRODUCT REPAIRS, please locate your nearest

Authorized Servicentre at www.panasonic.ca:

Link : "Servicentres™ locator" under "Customer support"

IF YOU SHIP THE PRODUCT TO A SERVICENTRE

Carefully pack and send prepaid, adequately insured and preferably in the original carton.

Include details of the defect claimed, and proof of date of original purchase.

U.S.A.

PANASONIC CONSUMER ELECTRONICS COMPANY,
DIVISION OF PANASONIC CORPORATION OF NORTH AMERICA
One Panasonic Way, Secaucus, New Jersey 07094

PANASONIC SALES COMPANY
DIVISION OF PANASONIC PUERTO RICO, INC.
Ave. 65 de Iniferteria, Km. 9.5, San Gabriel Industrial Park
Carolina, Puerto Rico 00985

PANASONIC AUTO PRODUCTS LIMITED WARRANTY

LIMITED WARRANTY COVERAGE

If your product does not work properly because of defects in materials and workmanship.

Panasonic Consumer Electronics Company or Panasonic Sales Company (collectively referred to as "the warrantor") will, for the length of the period indicated in the chart below, which starts with the date of original purchase ("warranty period"), at its option either (a) repair your product with new or refurbished parts, or (b) replace it with a new or refurbished product. The decision to repair or replace will be made by the warrantor.

Categories	Parts	Labor
Audio Components (except items listed below)	One (1) Year	One (1) Year
MXE Series Audio Components (except items listed below)	Two (2) Years	Two (2) Years
Speakers Defective Car Audio Speakers under warranty must be exchanged at the place of purchase. Contact your Dealer for details.	One (1) Year	Not Applicable
Accessories (in exchange for defective items)	Ninety (90) Days	Not Applicable

During the "Labor" warranty period, there will be no charge for labor. During the "Parts" warranty period, there will be no charge for parts. You must carry-in or mail-in your product prepaid during the warranty period. If nonrechargeable batteries are included, they are not warranted. This warranty only applies to products purchased and serviced in the United States or Puerto Rico. This warranty is extended only to the original purchaser of a new product which was not sold "as is". A purchase receipt or other proof of the original purchase date is required for warranty service.

CARRY-IN OR MAIL-IN SERVICE

For Carry-In or Mail-In Service in the United States, call 1-800-211-PANA (7262) or visit
Panasonic Web Site: <http://www.panasonic.com>
For assistance in Puerto Rico, call Panasonic Sales Company (787)-750-4300 or fax (787)-768-2910.

LIMITED WARRANTY LIMITS AND EXCLUSIONS

This warranty ONLY COVERS failures due to defects in materials and workmanship, and DOES NOT COVER normal wear and tear or cosmetic damage. The warranty ALSO DOES NOT COVER damages which occurred during shipment, failures which are caused by products not supplied by the warrantor, failures which result from accident, misuse, abuse, neglect, bug infestation, mishandling, misapplication, alteration, faulty installation, set-up adjustment, maladjustment of consumer control, improper maintenance, improper antenna, inadequate signal reception or pickup, power line surge, improper voltage supply, lightning, modification, commercial use (such as use in hotels, offices, restaurants, or other business uses) or rental use of the product, or service by anyone other than the technician from Factory Servicenter or other authorized service centers, or damage that is attributable to acts of God.

THERE ARE NO EXPRESS WARRANTIES EXCEPT AS LISTED UNDER "LIMITED WARRANTY COVERAGE". THE WARRANTOR IS NOT LIABLE FOR INCIDENTAL OR CONSEQUENTIAL DAMAGES RESULTING FROM THE USE OF THIS PRODUCT, OR ARISING OUT OF ANY BREACH OF THIS WARRANTY. (As examples, this excludes damages for lost time, cost of having someone remove or re-install an installed unit if applicable, travel to and from the sevice, and loss of media, data or other memory contents. The items listed are not exclusive, but are for illustration only.) **ALL EXPRESS AND IMPLIED WARRANTIES, INCLUDING THE WARRANTY OF MERCHANTABILITY, ARE LIMITED TO THE PERIOD OF THE LIMITED WARRANTY.**

Some states do not allow the exclusion or limitation of incidental or consequential damages, or limitations on how long an implied warranty lasts, so the exclusions may not apply to you.

This warranty gives you specific legal rights and you may also have other rights which vary from state to state. If a problem with this product develops during or after the warranty period, you may contact your dealer or Servicenter. If the problem is not handled to your satisfaction, then write to warrantor's Consumer Affairs Department at the addresses of the warrantor.

PARTS AND SERVICE WHICH ARE NOT COVERED BY THIS LIMITED WARRANTY ARE YOUR RESPONSIBILITY.

Customer's Record

Model _____
No. _____
Serial _____
No. _____
Dealer's _____
No. _____
Code _____
No. _____
Dealer's _____
Address _____
Date of _____
Purchase _____

CANADA

Panasonic Canada Inc.
5770 Ambler Drive, Mississauga Ontario L4W 2T3

PANASONIC PRODUCT LIMITED WARRANTY

Panasonic Canada Inc. warrants this product to be free from defects in materials and workmanship and agrees to remedy any such defect for a period as stated below from the date of original purchase.

CAR AUDIO PRODUCT – ONE (1) YEAR, PARTS AND LABOUR

(The labour to install or remove the product is not warranted)
ACCESSORIES - NINETY (90) DAYS, (IN EXCHANGE FOR DEFECTIVE ITEMS)

LIMITATIONS AND EXCLUSIONS

This warranty does not apply to products purchased outside Canada or to any product which has been improperly installed, subjected to usage for which the product was not designed, misused or abused, damaged during shipping, or which has been altered or repaired in any way that affects the reliability or detracts from the performance, nor does it cover any product which is used commercially. Dry cell batteries are also excluded from coverage under this warranty.

This warranty is extended to the original end user purchaser only. A purchase receipt or other proof of the original purchase date is required before warranty service is performed.

THIS EXPRESS, LIMITED WARRANTY IS IN LIEU OF ALL OTHER WARRANTIES, EXPRESS OR IMPLIED, INCLUDING ANY IMPLIED WARRANTIES OF MERCHANTABILITY AND FITNESS FOR A PARTICULAR PURPOSE.

IN NO EVENT WILL PANASONIC CANADA INC. BE LIABLE FOR ANY SPECIAL, INDIRECT OR CONSEQUENTIAL DAMAGES.

In certain instances, some jurisdictions do not allow the exclusion or limitation of incidental or consequential damages, or the exclusion of implied warranties, so the above limitations and exclusions may not be applicable.

Maintenance/Fuse

Cleaning the Unit

Your product is designed and manufactured to ensure the minimum of maintenance. Use a dry, soft cloth for routine exterior cleaning. Never use benzene, thinner, or other solvents.

Fuse

If the fuse blows out, consult your dealer, or your nearest authorized Panasonic Servicenter.

⚠ Warning

- Use fuses of the same specified rating (15 A). Using substitutes or fuses with higher ratings, or connecting the unit directly without a fuse could cause fire or damage to the unit. **If the replaced fuse fails, contact your nearest authorized Panasonic Servicenter.**

Anti-Theft System

This unit is equipped with a removable face plate. Removing this face plate makes the unit totally inoperable.

Notes:

- Do not touch the contacts on the face plate and the main unit, since this may result in poor electrical contact.
- If dirt or other foreign substances get on the contacts, wipe them off with a clean and dry cloth.

Removing

- 1 Turn off the power.
- 2 Press [▲]. The face plate will open.
- 3 Pull it out toward you.

CQ-RX400U CQ-RX100L

- 4 Put the face plate in the case.

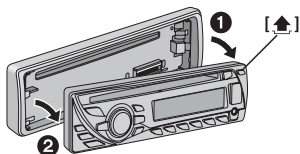

Mounting

- 1 Slide the left side of the face plate in place.
- 2 Press the right end of face plate until a "click" is heard.

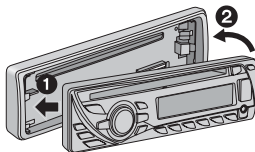

Face Plate Removing/Mounting

(Anti-Theft System)

Specifications

General

Power supply	:DC 12 V (11 V – 16 V DC), test voltage 14.4 V, negative ground
Current consumption	:Less than 2.1 A (CD mode; 0.5 W x 4 channels)
Maximum power output	:50 W x 4 channels (at 1 kHz), volume control maximum
Tone/SQ adjustment range	:SQ Low/Bass: ± 12 dB (at 60 Hz, 80 Hz, 100 Hz, 200 Hz) SQ Mid: ± 12 dB (at 500 Hz, 1 kHz, 2 kHz, 3 kHz) SQ High/Treble: ± 12 dB (at 10 kHz, 12 kHz, 15 kHz, 18 kHz)
Speaker impedance	:4 – 8 Ω
Pre-amp output voltage	:2.0 V (CD mode, 1 kHz, 0 dB)
Pre-amp output impedance	:200 Ω
USB Connector	CQ-RX400U
USB Standard Compatibility	:1.1/2.0 Full Speed
Maximum Supply Current	:500 mA
Front AUX input	
Input impedance	:10 k Ω
Allowable external input	:2.0 V
Connector	:3.5 mm ϕ Stereo mini-pin
Dimensions (W x H x D)	:178 x 50 x 160 mm (7" x 1 15/16" x 6 5/16")
Weight	:1.2 kg (2 lbs. 10 oz)

Disc Player

Sampling frequency	:8 times oversampling
DA converter	:1 bit DAC System
Pick-up type	:Astigma 3-beam
Light source	:Semiconductor laser
Wave length	:790 nm
Frequency response	:20 Hz – 20 kHz (± 1 dB)
Signal to noise ratio	:96 dB
Total harmonic distortion	:0.01 % (1 kHz)
Wow and flutter	:Below measurable limits
Channel separation	:85 dB

FM Radio

Frequency range	:87.9 MHz – 107.9 MHz
Usable sensitivity	:10.2 dBf. (0.9 μ V, 75 Ω)
50 dB quieting sensitivity	:15.2 dBf. (1.6 μ V, 75 Ω)
Frequency response	:30 Hz – 15 kHz (± 3 dB)
Alternate channel selectivity	:75 dB
Stereo separation	:35 dB (at 1 kHz)
Image rejection ratio	:55 dB
IF rejection ratio	:100 dB
Signal/noise ratio	:62 dB

AM Radio

Frequency range	:530 kHz – 1 710 kHz
Usable sensitivity	:27 dB μ V (22 μ V, S/N 20 dB)

Above specifications comply with EIA standards.

Power Output:
18 W RMS x 4 Channels at 4 Ω and $\leq 1\%$ THD+N
Signal to Noise Ratio:
85 dBA (reference: 1 W into 4 Ω)



Notes:

- Specifications and design are subject to modification without notice due to improvements.
- Some figures and illustrations in this manual may be different from your product.

Panasonic Consumer Electronics Company, Division of Panasonic Corporation of North America
One Panasonic Way, Secaucus,
New Jersey 07094
<http://www.panasonic.com>

Panasonic Sales Company, Division of Panasonic Puerto Rico, Inc. ("PSC")
Ave. 65 de Infanteria, Km. 9.5
San Gabriel Industrial Park,
Carolina, Puerto Rico 00985
<http://www.panasonic.com>

Panasonic Canada Inc.
5770 Ambler Drive,
Mississauga, Ontario
L4W 2T3
<http://www.panasonic.ca>

Caution

Observe the following cautions when using this unit.

- ❑ **Keep the sound volume at an appropriate level.**
Keep the volume level low enough to be aware of road and traffic conditions while driving.
- ❑ **This unit is designed for use exclusively in automobiles.**
- ❑ **Do not operate the unit for a prolonged period with the engine turned off.**
Operating the audio system for a long period of time with the engine turned off will drain the battery.

- ❑ **Do not expose the unit to direct sunlight or excessive heat.**
Otherwise these will raise the interior temperature of the unit, and it may lead to smoke, fire, or other damage to the unit.

- ❑ **Do not use the product where it is exposed to water, moisture, or dust.**
Exposure of the unit to water, moisture, or dust may lead to smoke, fire, or other damage to the unit. Make especially sure that the unit does not get wet in car washes or on rainy days.

- ❑ **Set the volume level to low enough before the AUX connection is completed.**
Failure to observe this, the loud noise may come out and damage your speakers and your hearing. Direct connection of the speaker/headphone output of an external device without any attenuator may distort sound or damage the connected external device.

Observe the following cautions when installing.

- ❑ **Refer wiring and installation to qualified service personnel.**
Installation of this unit requires special skills and experience. For maximum safety, have it installed by your dealer. Panasonic is not liable for any problems resulting from your own installation of the unit.

- ❑ **Follow the instructions to install and wire the product.**
Not following the instructions to properly install and wire the product could cause an accident or fire.

- ❑ **Take care not to damage the leads.**
When wiring, take care not to damage the leads. Prevent them from getting caught in the vehicle chassis, screws, and moving parts such as seat rails. Do not scratch, pull, bend or twist the leads. Do not run them near heat sources or place heavy objects on them. If leads must be run over sharp metal edges, protect the leads by winding them with vinyl tape or similar protection.

- ❑ **Use the designated parts and tools for installation.**
Use the supplied or designated parts and appropriate tools to install the product. The use of parts other than those supplied or designated may result in internal damage to the unit. Faulty installation may lead to an accident, a malfunction or fire.

- ❑ **Do not block the air vent or the cooling plate of the unit.**
Blocking these parts will cause the interior of the unit to overheat and will result in fire or other damage.

- ❑ **Do not install the product where it is exposed to strong vibrations or is unstable.**

Avoid slanted or strongly curved surfaces for installation. If the installation is not stable, the unit may fall down while driving and this can lead to an accident or injury.

- ❑ **Installation Angle**

The product should be installed in a horizontal position with the front end up at a convenient angle, but not more than 30°. The user should bear in mind that in some areas there may be restrictions on how and where this unit must be installed. Consult your dealer for further details.

- ❑ **Wear gloves for safety. Make sure that wiring is completed before installation.**
- ❑ **To prevent damage to the unit, do not connect the power connector until the whole wiring is completed.**
- ❑ **Do not connect more than one speaker to one set of speaker leads. (except for connecting to a tweeter)**

Observe the following cautions when handling the battery for the remote control unit.

- Use only specified battery (CR2025).
- Match the polarity of the battery with the (+) and (-) marks in the battery case.
- Replace a dead battery as soon as possible.
- Remove the battery from the remote control unit when not using it for an extended period of time.
- Insulate the battery (by placing them in a plastic bag or covering them with vinyl tape) before disposal or storage.
- Dispose of the battery according to the local regulations.
- Do not disassemble, recharge, heat or short the battery. Do not throw a battery into a fire or water.

In case of battery leakage

- Thoroughly wipe the battery liquid off the battery case and insert new battery.
- If any part of your body or clothing comes into contact with battery liquid, wash it with plenty of water.
- If battery liquid comes into contact with your eyes, wash them with plenty of water and get immediate medical attention.

Observe the following cautions when using USB device. **CCQ-RX400U**

- Do not connect a USB device directly to this unit. If the USB device is connected directly to this unit and an accident occurs, or if the brakes are applied suddenly, the driver or passenger may bump into the USB device and may get injured.
- Position the USB device and USB extension cable so that they do not obstruct your driving.
- Do not connect any USB device other than USB memory, a USB audio player or iPod series. Do not connect multiple USB devices to the USB connector. Drawing power for multiple USB devices from the connector could cause overheating and smoking.

Caution

**THIS PRODUCT IS A CLASS 1 LASER PRODUCT.
USE OF CONTROLS OR ADJUSTMENTS OR PERFORMANCE OF
PROCEDURES OTHER THAN THOSE SPECIFIED HEREIN MAY
RESULT IN HAZARDOUS RADIATION EXPOSURE.
DO NOT OPEN COVERS AND DO NOT REPAIR BY YOURSELF.
REFER SERVICING TO QUALIFIED PERSONNEL.**

The following applies only in the U.S.A.

Part 15 of the FCC Rules

FCC Warning:

Any unauthorized changes or modifications to this equipment would void the user's authority to operate this device.

Notice

This product contains a CR Coin Cell Lithium Battery which contains Perchlorate Material - special handling may apply.
See www.dtsc.ca.gov/hazardouswaste/perchlorate.

Notes on Discs

If you use commercial CDs, they must have either of these labels shown at right.

Some copy-protected music CDs are not playable.



How to hold the disc

- Do not touch the underside of the disc.
- Do not scratch on the disc.
- Do not bend the disc.
- When not in use, keep disc in the case.



Do not use discs that fit any of the descriptions given below. Using these discs may damage the discs or cause the unit to malfunction.

- Special discs in a shape which is not round



- Partly or wholly transparent disc

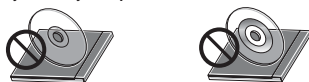

Wholly transparent disc

Partly transparent disc

Wholly semi-transparent disc may not be played back.

- Discs with adhered labels, etc. on them



Disc with adhered stickers or tape

Labels created by a printer

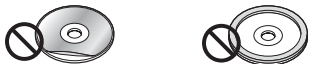

Protective films or sheets

Discs accessories (stabilizers, etc.)

- Damaged or deformed discs



Shoddily made discs

Discs with cracks, scratches or parts missing



Discs with burrs
Please remove the burrs before use.

Disc Insert

The surfaces of new discs tend to be slippery. Therefore, when using such a disc for the first time, it may not load satisfactorily even when it has been inserted into the unit. At a time like this, insert the disc into the unit as far as it will go until it is loaded properly.

- When inserting a disc into or ejecting and removing it from the unit, insert it straight in or eject and remove it straight out in parallel with the unit.
Observe, the disc may be scratched or marked in the process.
- When inserting a disc, do not put one disc on another.
Failure to observe this may cause the discs to be jammed.

Do not leave discs in the following places:

- Direct sunlight
- Near car heaters
- Dirty, dusty and damp areas
- On seats and dashboards

Disc cleaning

- Use a dry, soft cloth to wipe from the center outward.



<Correct>



<Wrong>

- Do not attach any seals or labels to your discs.
- Do not write on the disc label in a heavy pen or ballpoint pen.

Notes on CD-Rs/RWs

- You may have trouble playing back some CD-R/RW discs recorded using CD recorders (CD-R/RW drives), either due to their recording characteristics or dirt, fingerprints, scratches, etc. on the disc surface.
- CD-R/RW discs are less resistant to high temperatures and high humidity than ordinary music CD. Leaving them inside a car for extended periods may damage and make playback impossible.
- The unit may not successfully playback a CD-R/RW, that was made by the combination of writing software, a CD recorder (CD-R/RW drive) and a disc if they are incompatible with one another.
- This player cannot play the CD-R/RW discs if the session is not closed.
- Be sure to observe the handling instructions of CD-R/RW discs.
- This player cannot play CD-R/RW discs which contain other than CD-DA or MP3/WMA/AAC data (Video CD, etc.).

Notes on MP3/WMA/AAC

Playable Audio File

CQ-RX400U	MP3/WMA/AAC
CQ-RX200U	MP3/WMA
CQ-RX100U	MP3/WMA
CQ-RX100L	MP3/WMA

Notes for AAC playback is only for the model CQ-RX400U.

What is MP3/WMA/AAC?

MP3* (MPEG Audio Layer-3) and WMA (Windows Media™ Audio) are the compression formats of digital audio. The former is developed by MPEG (Motion Picture Experts Group), and the latter is developed by Microsoft Corporation. Using these compression formats, you can record the contents of about 10 music CDs on a single CD media (This figures refer to data recorded on a 650 MB CD-R or CD-RW at a fixed bit rate of 128 kbps and a sampling frequency of 44.1 kHz).

*MPEG Layer-3 audio coding technology licensed from Fraunhofer.

AAC is an abbreviation for "Advanced Audio Coding". It has been defined as a standard for audio compression technology using MPEG 2 and MPEG 4.

Note: MP3/WMA/AAC encoding and writing software is not supplied with this unit.

Points to Remember When Making MP3/WMA/AAC Files

Common

- High bit rate and high sampling frequency are recommended for high quality sounds.
- Selecting VBR (Variable Bit Rate) is not recommended because playing time is not displayed properly and sound may be skipped.
- The playback sound quality differs depending on the encoding circumstances. For details, refer to the instructions of your own encoding software and writing software.

MP3

- It is recommended to set the bit rate to "128 kbps or more" and "fixed".

WMA

- It is recommended to set the bit rate to "64 kbps or more" and "fixed".
- Do not set the copy protect attribute on the WMA file to enable this unit to play back.

AAC

- It is recommended to set the bit rate to "128 kbps or more" and "fixed".
- The formats and extensions for AAC data vary according to the encoder software used.
- AAC files which can be played on this unit have the ".m4a" extension and were encoded with Apple iTunes® version 7.

- The file extension for files encoded with the iTunes Apple Lossless Encoder is ".m4a", but such files cannot be played on this player.
- Files under copyright protection cannot be played.

Caution

Never assign the ".mp3", ".wma" or ".m4a" file name extension to a file that is not in the MP3/WMA/AAC format. This may not only produce noise from the speaker damage, but also damage your hearing.

iTunes is a trademark of Apple Inc., registered in the U.S. and other countries/regions.

Windows Media, and the Windows logo are trademarks, or registered trademarks of Microsoft Corporation in the United States and/or other countries/regions.



Display Information

Displayed items

- **CD-TEXT**
 - Disc title
 - Track title
 - **MP3/WMA/AAC**
 - Folder name
 - File name
 - **AAC (Song information)**
 - Album name
 - Title name/artist name
- **MP3 (ID3 tag)**
 - Album name
 - Title name/artist name
 - **WMA (WMA tag)**
 - Album name
 - Title name/artist name

Displayable characters

- Displayable length of file name/folder name: within 32 characters. (Unicoded file and folder names are reduced by half in the number of displayable characters.)
- Name files and folders in accordance with the standard of each file system. Refer to the instructions of writing software for details.
- ASCII character set and special characters in each language can be displayed.
- Some Cyrillic characters in the Unicode can be displayed.

ASCII character set

A to Z, a to z, digits 0 to 9, and the following symbols:
(space) ! " # \$ % & ' () * + , - . / : ; < = > ? @ [\] ^ _ ` { | } ~

Special Characters

À Á Â Ã Ä Å Æ ç è é ê ë ì
 ï ð ñ ò ó ô õ ö ø ù ú û ü

Notes:

- With some software in which MP3/WMA/AAC format files have been encoded, the character information may not be displayed properly.
- Undisplayable characters and symbols will be converted into an asterisk (*).
- It is recommended that the length of the file name is less than 8 characters (excluding the file extension).

Compression formats

(Recommendation: "Points to Remember When Making MP3/WMA/AAC Files" → Left)

CO-RX400U

Compression method	Bit rate	VBR	Sampling frequency
MPEG 1 Audio Layer-3 (MP3)	32 k – 320 kbps	Yes	32, 44.1, 48 kHz
MPEG 2 Audio Layer-3 (MP3)	8 k – 160 kbps	Yes	16, 22.05, 24 kHz
MPEG 2.5 Audio Layer-3 (MP3)	8 k – 160 kbps	Yes	8, 11.025, 12 kHz
Windows Media Audio Ver. 2 – 9*	64 k – 160 kbps	Yes	32, 44.1, 48 kHz
MPEG 4 Advanced Audio Coding Low Complexity (AAC LC)	16 k – 320 kbps	Yes	8, 11.025, 12, 16, 22.05, 24, 32, 44.1, 48 kHz

* WMA 9 Professional/LossLess/Voice are not supported.

Recording MP3/WMA/AAC Files on a CD-Media/USB-Device

- You are recommended to minimize the chances of making a disc that contains both CD-DA files and MP3/WMA/AAC files.
- If CD-DA files are on the same disc as MP3, WMA or AAC files or the songs may not play in the intended order, or some songs may not play at all.
- When storing MP3 data, WMA data or AAC data on the same disc, use different folders for each data.
- Do not record files other than MP3/WMA/AAC files and unnecessary folder on a disc.
- The name of an MP3/WMA/AAC file should be added by rules as shown in the following descriptions and also comply with the rules of each file system.
- The file extension ".mp3", ".wma" or ".m4a" should be assigned to each file depending on the file format.
- You may encounter trouble in playing MP3/WMA/AAC files or displaying the information of MP3/WMA/AAC files recorded with certain writing software or CD recorders.
- This unit does not have a play list function.
- Although Multi-session recording is supported, the use of Disc-at-Once is recommended.

Supported file systems

■ CD-media

ISO 9660 Level 1/Level 2, Apple Extension to ISO 9660, Joliet, Romeo

Note: Apple HFS, UDF 1.50, Mix CD and CD Extra are not supported.

■ USB-device **CO-RX400U**

File system is FAT12/16/32

CQ-RX200U CQ-RX100U CQ-RX100L

Compression method	Bit rate	VBR	Sampling frequency
MPEG 1 Audio Layer-3 (MP3)	32 k – 320 kbps	Yes	32, 44.1, 48 kHz
MPEG 2 Audio Layer-3 (MP3)	8 k – 160 kbps	Yes	16, 22.05, 24 kHz
MPEG 2.5 Audio Layer-3 (MP3)	8 k – 160 kbps	Yes	8, 11.025, 12 kHz
Windows Media Audio Ver. 2 – 9*	64 k – 160 kbps	Yes	32, 44.1, 48 kHz

* WMA 9 Professional/LossLess/Voice are not supported.

Folder Selection Order/File Playback Order

Maximum number of files/folders

- Maximum depth of trees: 8

CQ-RX400U

- Maximum number of files
 - CD-media: 999
 - USB device: 65 535
- Maximum number of files in one folder
 - CD-media: 999
 - USB device: 999
- Maximum number of folders:
 - CD-media: 256 (Root folder is included.)
 - USB device: 255 (Root folder is included.)

CQ-RX200U CQ-RX100U CQ-RX100L

- Maximum number of files: 999
- Maximum number of files in one folder: 999
- Maximum number of folders: 256 (Root folder is included.)

Notes:

- You can shorten the duration between data read and playback by decreasing the quantity of files or folders, or the depth of the hierarchy.
- This unit counts the number of folders irrespective of the presence or absence of an MP3/WMA/AAC file.
- If the selected folder does not contain any MP3/WMA/AAC files, the nearest MP3/WMA/AAC files in the order of playback will be played.
- Playback order may be different from other MP3/WMA/AAC players even if the same disc is used.
- “ROOT” appears when displaying the root folder name.

CQ-RX400U

- Empty folders stored on the USB memory are not included in the folder count.
- Depending on the connected USB memory, the order in which the files are played back may differ to the order in which the files were stored.

CD-media

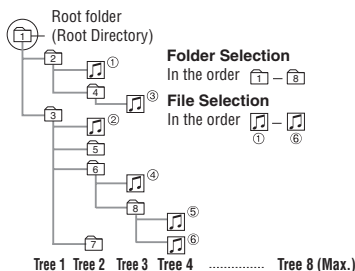

USB-device CQ-RX400U

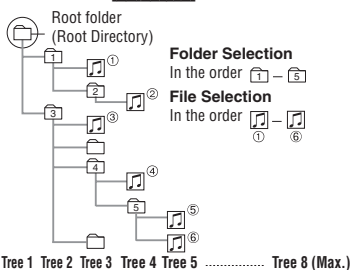

Copyright

It is prohibited by copyright laws to copy, distribute and deliver copyrighted materials such as music without the approval of copyright holder except enjoying yourself personally.

No warranty

Above description complies with our investigations as of September 2007. It has no warranty for reproducibility and displayability of MP3/WMA/AAC.

Preparation

First Time Power On

- 1 Set your car's ignition switch to the ACC or ON position.



- 2 Press [SRC] (PWR: Power).

Cancellation of Demonstration

CQ-RX400U CQ-RX200U

The demonstration message appears for initial use.

- 1 Set your car's ignition switch to the ACC or ON position.



- 2 Press [SRC] (PWR: Power).
- 3 Hold down [VOL] (PUSH SEL: Select) for 2 sec. or more to open the function menu.

- 4 Press [VOL] (PUSH SEL: Select) to select DEMO.

- 5 Turn [VOL] counterclockwise. For using the remote control, press [0] (V).



Notes:

- To return to the regular mode, press [DISP].
- Refer to the section on "Function Settings".
- When "NO USB" (CQ-RX400U) or "NO DISC" is displayed, the Demonstration cannot be cancelled.

Battery Installation

Pull the insulation film out from the backside of the remote control gently.

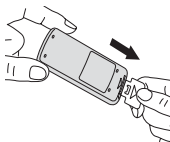

Note: Battery Information:

Battery Type: Panasonic lithium battery (CR2025) (Included in the remote control)

Battery Life: Approximately 6 months under normal use (at room temperature)

Clock Setting

The 12-hour system is used for the clock.

- 1 Press [DISP].



- 2 Hold down [DISP] for more than 2 seconds.



- 3 Adjust the hour.



[▶▶]: sets the hour ahead.
[◀◀]: sets the hour back.

- 4 Press [DISP].



- 5 Adjust the minute.



[▶▶]: sets the minute ahead.

[◀◀]: sets the minute back.

- 6 Press [DISP].



Notes:

- "ADJUST" is displayed before adjusting the clock.
- Hold down [◀◀] or [▶▶] to change numbers rapidly.
- When "NO DISC" is displayed, the clock cannot be adjusted.

Clock Display at Power Off

Press [DISP] to change the display.

Display off



8:15 Clock display (Default)

General

[SRC] (Source)
selects a source.
[PWR] (Power)
toggles power on/off.

Remote Control Sensor
[VOL] (Volume)



[SQ] (Sound Quality)
selects a sound type (SQ).

AUX1 Connector (3.5 mm ϕ stereo)
From line output of external sound/audio device (ex. Silicon-audio player, HDD player, etc.)

⚠ Caution

- Set the volume level to low enough before the AUX connection is completed. Failure to observe this, the loud noise may come out and damage your speakers and your hearing.

Power On/Off

Set your car's ignition switch to the ACC or ON position.

Power on: Press **[SRC]** (**PWR**).

Power off: Hold down **[SRC]** (**PWR**) for more than 1 second.

Volume Adjustment

(Setting Range: 0 to 40, Default: 18)

Turn **[VOL]**.

Source Selection

Press **[SRC]** to change the source.

CQ-RX400U

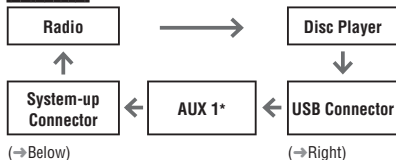

Note: Select USB Connector mode to operate the iPod series connected with USB connector. (→ **System Upgrade Guidebook**)

(→Continued below)

■ USB Connector

CQ-RX400U

When an optional USB memory is connected:

When loading MP3/WMA/AAC data

USB

When an optional USB memory is not connected:

NO USB

Radio (AM/FM)

[SRC] (Source)
selects a source.

[DISP] (Display)
switches the information on the display.

[BAND]
selects a band in the radio source.

[APM] (Auto Preset Memory)
executes APM in the radio source. (Hold it down for more than 2 seconds.)

[TUNE ◀◀] [TUNE ▶▶]
down/up the frequency. (Hold it down for more than 0.5 seconds and release it for seek tuning.)



Preset buttons [1] to [6]
selects a preset station in the radio source, and presets the current station. (Hold it down for more than 2 seconds.)

Operation Flow

1 Press **[SRC]** to select the radio source.

2 Press **[BAND]** to select a band.



3 Select a station.

Frequency Adjustment

[TUNE ◀◀]: Lower

[TUNE ▶▶]: Higher

Note: Hold down for 0.5 sec. or more and release for station search.

Preset Station Selection

Press the corresponding preset button from **[1]** to **[6]** to tune in a preset station.

Radio Source Display



Display Change

Press **[DISP]** to change the display.

FM1 88.9 4 Radio mode display (Default)



1235 Clock display

Station Preset

Up to 6 stations can be preset in AM, FM1, FM2, and FM3 respectively. Preset stations can be simply called up by pressing **[1]** to **[6]**.

Auto Preset Memory (APM)

With this operation, stations with good receiving conditions can be automatically stored in the preset memory.

1 Select a band.

2 Hold down **[BAND]** (**APM**) for more than 2 seconds.

The preset stations under best receiving conditions are received for 5 seconds each after presetting the stations (SCAN). To stop scanning, press one of the buttons from **[1]** to **[6]**.

Note: New stations overwrite existing saved stations.

Manual Station Preset

1 Tune into a station.

2 Hold down one of the preset buttons from **[1]** to **[6]** for more than 2 seconds.



Note: New stations overwrite existing saved stations.

Audio Settings

[VOL] selects a value in the audio menu.
(PUSH SEL) (Push to select) selects items in the audio menu.

[DISP] (Display) exits from the audio menu.



- 1 Press **[VOL]** (**PUSH SEL**) to open the audio menu.
Note: If no operation takes place for more than 5 seconds in audio setting (2 seconds in the volume adjustment, 10 seconds in the SQ adjustment), the display returns to the regular mode.
- 2 Press **[VOL]** (**PUSH SEL**) to select a mode to be adjusted.
- 3 Turn **[VOL]** clockwise or counterclockwise to adjust.

Audio Menu

VOL 18	Volume
(Setting Range: 0 to 40, Default: 18)	
BASS	Bass
(Setting Range: -12 dB to +12 dB by 2 dB, Default: 0 dB)	
TREBLE	Treble
(Setting Range: -12 dB to +12 dB by 2 dB, Default: 0 dB)	
SQ SET	SQ Adjustment
(Tone/SQ adjustable range: -12 dB to +12 dB (by 2 dB))	
Setting range:	
SQ Low/Bass: ±12 dB (at 60 Hz, 80 Hz, 100 Hz, 200 Hz)	
SQ Mid: ±12 dB (at 500 Hz, 1 kHz, 2 kHz, 3 kHz)	
SQ High/Treble: ±12 dB (at 10 kHz, 12 kHz, 15 kHz, 18 kHz)	
BALANCE	Balance
(Setting Range: 15 levels each, Default: CNT (center))	
FADER	Fader
(Setting Range: 15 levels each, Default: CNT (center))	

VOL 18	<p>①: Up ②: Down</p>
BASS: 6dB	<p>①: Increased ②: Decreased</p>
TRE: 6dB	<p>①: Increased ②: Decreased</p>
60HZ ±6	<p>①/②: center frequency up/down [◀][▶]: Band selection [^][v]: Level up/down</p>
BAL L 15	<p>①: Right enhanced ②: Left enhanced</p>
FAD F 15	<p>①: Front enhanced ②: Rear enhanced</p>

Notes:

- The volume can also be adjusted directly using **[VOL]** on the main unit. (→ "General")
- For further information on SQ (Sound Quality) settings, refer to "Sound Control".
- Do not activate SQ and Bass/Treble at the same time to avoid causing sound distortion.
CQ-RX400U **CQ-RX200U**
- The sequence and contents of setting items may depend on the conditions of devices to be connected. For further information, refer to the **System Upgrade Guidebook** or the instruction manuals for the devices to be connected.
CQ-RX200U **CQ-RX100U** **CQ-RX100L**
- If the fader is set to front, the pre-amp. output (rear) is decreased.

Function Settings

[VOL] —————
 selects a value in the function menu.
(PUSH SEL) (Push to select)
 selects items in the function menu.

[DISP] (Display) —————
 exits from the function menu.



- 1 Hold down **[VOL]** (**PUSH SEL**) for 2 sec. or more to open the function menu.
Note: If no operation takes place for more than 5 seconds in function setting, the display returns to the regular mode.
- 2 Press **[VOL]** (**PUSH SEL**) to select a mode to be adjusted.
- 3 Turn **[VOL]** clockwise or counterclockwise to adjust.

Function Menu

DEMO Demonstration

CQ-RX400U CQ-RX200U

You can set up the monitor to display or hide the demonstration screen.

Note: Button operation with either the main unit or remote control allows users to cancel the demonstration screen for 20 seconds and enable the selected operation even in the demo-on mode.

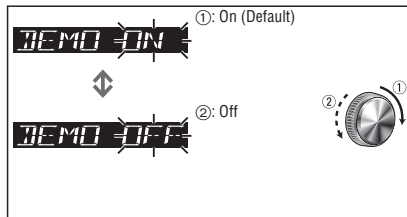

MUTE KEY Mute/Attenuation

You can select mute or attenuation.

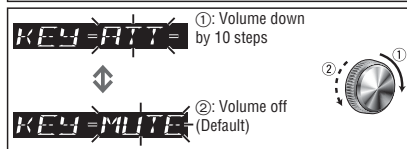

CQ-RX400U CQ-RX200U AUX1 Skip

AUX 1 IN

If AUX1 is not used, the AUX1 mode is skipped when selecting the source.

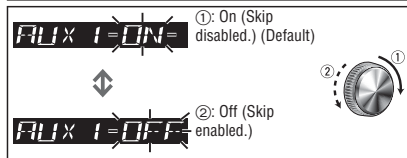

CQ-RX100U CQ-RX100U AUX Skip

AUX IN

If AUX is not used, the AUX mode is skipped when selecting the source.

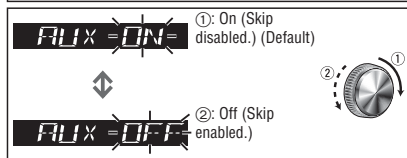

Notes:

- To return to the regular mode, press **[DISP]**.

CQ-RX400U CQ-RX200U

- The sequence and contents of setting items may depend on the conditions of devices to be connected. For further information, refer to the **System Upgrade Guidebook** or the instruction manuals for the devices to be connected.

Sound Control

SQ Selection Based on Genre SQ (Sound Quality)

You have 6 preset modes (FLAT, ROCK, POP, VOCAL, JAZZ, CLUB). You can customize your settings for these and save them for instant recall.

SQ Changeover

- 1 Press **[SQ]** to activate the SQ selection mode.
- 2 Press **[SQ]** to select the sound type as follows.

Press **[DISP]** to return to the regular mode.

Notes:

- After pressing **[SQ]** on the main unit, you can also select a sound type by pressing the preset buttons **[1]** to **[6]**.
- Please refer to "Audio Settings" for the adjustment to each speaker.

SQ-FLAT 1

(FLAT) flat frequency response:
does not emphasize any part. (Default)

SQ-ROCK 2

(ROCK) speedy and heavy sound:
exaggerates bass and treble.

SQ-POP 3

(POP) wide-ranged and deep sound:
slightly emphasizes bass and treble.

SQ-VOCAL 4

(VOCAL) clear sound:
emphasizes middle tone and slightly emphasizes treble.

SQ-JAZZ 5

(JAZZ) jazz-specific deep sound:
sound with emphasis on sharpness of high-hat and echo saxophone.

SQ-CLUB 6

(CLUB) club and disco-specific sound:
reproduction of realism being in a club.

SQ Adjustment

You can adjust the characteristics of the currently selected sound type (SQ). (⇒ Above)
It is also possible to preset up to 5 different adjusted SQs.

SQ3 (3-Band Sound Quality)

Center frequency and level are adjustable in each of 3 bands. This lets you fine-tune sound quality for each genre to suit car-interior acoustics and your personal preferences.
Tone/SQ adjustable range: -12 dB to +12 dB (by 2 dB)

SQ Low/Bass: ±12 dB (at 60 Hz, 80 Hz, 100 Hz, 200 Hz)

SQ Mid: ±12 dB (at 500 Hz, 1 kHz, 2 kHz, 3 kHz)

SQ High/Treble: ±12 dB (at 10 kHz, 12 kHz, 15 kHz, 18 kHz)

- The bass/treble control level of each frequency is fixed to the frequency that has been selected for SQ.

To return an adjusted SQ to the default setting

- 1 Press **[SQ]**, and select the SQ which is to be returned to the default setting. (Only for main unit)
- 2 Hold down **[BAND]** for 2 sec. or more.

Notes:

- You cannot save any SQ presetting value in **[1]** button.
- Any SQ adjustments will not change the call up screen names such as ROCK and JAZZ.
- Do not activate SQ and Bass/Treble at the same time to avoid causing sound distortion.

1 Press **[VOL]** (**PUSH SEL:** Select) to open the audio menu.



2 Press **[VOL]** (**PUSH SEL:** Select) to select SQ SET.

3 Adjust each band.

①/②: center frequency up/down

[<<][>>]: Band selection

[^][v]: Level up/down



60Hz +6 — Level
Frequency

4 Hold down the numeric button **[2]** to **[6]** for 2 sec. or more.

- The adjusted SQ is preset in the number of the selected button, and return to the regular mode resumes.
- When you suspend the SQ preset adjustment, each level remains your recent adjustment until a new SQ presetting operation is performed or you call up the SQ preset.

Remote Control Unit

Notes:

- This instruction manual explains operations for use with the buttons on the main unit. (Different operations excluded)
- Aim the remote control at the remote sensor and operate it.

[0] to [9]

selects a preset station (1 to 6),
presets the current station (Hold it down for more than
2 seconds.),

inputs the number in direct selection.

[#] (NUMBER)

executes the direct selection.

[RANDOM] [SCAN] [REPEAT]

toggles on/off each play mode.

[<] [>]

down/up the frequency (Hold it down for more than
0.5 seconds and release it for seek tuning.)

[V] [^]

skip to the previous/next folder in player mode.

[◀◀] [▶▶]

skip to the previous/next track/file in player mode. Hold
it down for fast reverse/fast forward.

[BAND] (SET)

selects a band in the tuner source, toggles pause/play in player source,
executes the APM (Auto Preset Memory) in tuner source
(Hold it down for more than 2 seconds).

[SRC] (SOURCE)

selects a source.

(POWER)

toggles power on/off.

[MENU] (SEL: Select)

selects the items in the audio menu.

[VOL] (volume)

adjusts the volume, and selects the
value in the audio menu, etc.

[MUTE]

toggles mute on/off.

(Only for remote control unit)

Note: You can select mute or
attenuation. (→ "Function Settings")

[DISP] (Display)

switches the information on display,
and exits the audio menu.



Direct Access

A track (CD mode), file, folder (MP3/WMA/AAC mode) can
be directly selected.

Example: Track number 5

- 1 Press [#] (NUMBER).
- 2 Press [5].
- 3 Press [BAND] (SET).

Notes:

- To suspend direct selection, press [DISP].
- For folder selection, enter a number after pressing [#]
(NUMBER) twice.

Functions only on Main unit

The following functions are not available on remote control
unit.

- SQ selection
- Disc eject
- Scroll
- Tag on/off

Battery Replacement

- 1 Remove the battery holder with
the remote control unit placed on a
flat surface.

- 1 Stick your thumbnail into
the groove, and push the
holder in the direction of
the arrow, and at the same
time.

- 2 Pull it out in the direction
of the arrow using a tough
pointed object.

Tough pointed object

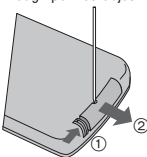

Back side

- 2 Put a battery in the
case with (+) side
facing up.
- 3 Put the case back.

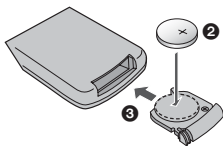

Warning

Keep batteries and insulation film out of reach of infants.
Batteries and insulation film can be ingested, so keep
them out of the reach of infants. If an infant ingests a
battery or insulation film, please seek immediate medical
attention.

Caution

- Remove and dispose of an old battery immediately.
- Do not disassemble, heat or short a battery. Do not
throw a battery into a fire or water.
- Follow local regulations when disposing of a battery.
- Improper use of batteries may cause overheating, an
explosion or ignition, resulting in injury or a fire.

Notice

This product contains a CR Coin Cell Lithium Battery
which contains Perchlorate Material - special handling
may apply.

See www.dtsc.ca.gov/hazardouswaste/perchlorate.

Notes: Battery Information:

Battery Type: Panasonic lithium battery (CR2025) (Included
in the remote control)

Battery Life: Approximately 6 months under normal use (at
room temperature)

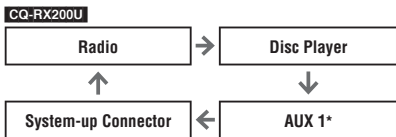

(→Right)

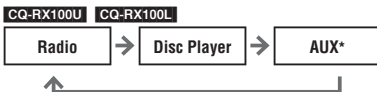

AUX1 Connector

AUX IN*:

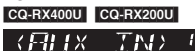

Note: The connector is labeled "AUX1", but it appears on the display as "<AUX IN>".

System-up Connector

CQ-RX400U CQ-RX200U

When an optional device is connected:

Shift to connected device

When connecting CD changer



When connecting iPod



When connecting XM Receiver



When connecting Sirius Receiver



When connecting Bluetooth® Unit



OR

When an expansion module is connected:

The devices connected to the ports 1 to 4 are activated in sequence after shifting to AUX2 (device connected to the AUX terminal of the expansion module).

CQ-RX400U CQ-RX200U

Note: For information about connectable devices, refer to the **System Upgrade Guidebook** or the instruction manual for each device.

Player (Disc Player)

Notes:

- The power will be turned on automatically when a disc is loaded.
- A disc which has both CD-DA data and MP3/WMA/AAC data on it may not be reproduced normally.

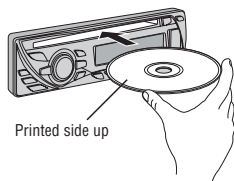

Printed side up

Disc slot
takes a disc in with the printed side facing up.

[V] [^]
skip to the previous/next folder.

[▲] (Eject)
ejects the disc.

[SRC] (Source)
selects a source.

[DISP] (Display)
switches the information on the display.

[▶||] (Play/Pause)
toggles pause/play in the player source.

[◀◀] [▶▶]
skip to the previous/next track/file in the player mode.
Hold down either of them for fast reverse/fast forward.

[4] (RANDOM)/[5] (SCAN)/[6] (REPEAT)
toggles on/off each play mode.

[3] (SCROLL)
scrolls the information on display.

Notes:

- Do not insert a disc when the **DISC** indicator lights.
- Refer to the section of "Notes on Discs" and "Notes on MP3/WMA/AAC".
- This unit does not support 8 cm (3") discs.

- If you insert an 8 cm (3") disc and cannot eject it, turn ACC of your car off once and turn it on again, then press [▲] (Eject).
- Do not insert foreign matter into the disc slot.

Pause

Press [BAND] [▶||].

Press again to cancel.

1 Press [SRC] to select the Disc Player source.

2 Select a desired portion.

Track/File Selection

Press [◀◀] / [▶▶].

Note: To perform fast forward/reverse, hold down either of them.

Disc Player (CD-DA disc):

Previous/next track

Disc Player (MP3/WMA/AAC disc):

Previous/next file

Folder Selection (MP3/WMA/AAC)

Press [V] / [^].

Playable Audio File

CQ-RX400U	MP3/WMA/AAC
CQ-RX200U	MP3/WMA
CQ-RX100U	MP3/WMA
CQ-RX100L	MP3/WMA

Notes for AAC playback is only for the model CQ-RX400U.

CD-DA Mode Display

Lights when the disc is loaded.

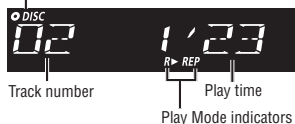

MP3/WMA/AAC Mode Display



Display Change

Press **[DISP]** to change the display.

Disc Player
(CD-DA disc):



Disc Player (MP3/WMA/AAC disc):

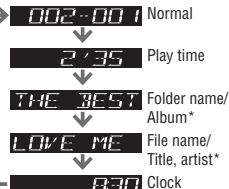

*ID3/WMA/AAC Tag On/Off

Hold down **[3]** for more than 2 seconds.

TAG ON

album title and song title/
artist name are displayed.

TAG OFF (Default)

folder name/file name are
displayed.

Notes:

- For scrolling text, press **[3]** (**SCROLL**).
- "NO TEXT" is displayed when there is no information on the disc.

Random Play

All the available songs (tracks/files) are played in a random sequence.

Press **[4]** (**RANDOM**).

Press again to cancel.

Folder Random Play (MP3/WMA/AAC)

All the available files in current folder are played in a random sequence.

Hold down **[4]** (**RANDOM**) for more than 2 seconds.

Hold down again to cancel.

Repeat Play

The current song (track/file) is repeated.

Press **[6]** (**REPEAT**).

Press again to cancel.

Folder Repeat Play (MP3/WMA/AAC)

The current folder is repeated.

Hold down **[6]** (**REPEAT**) for more than 2 seconds.

Hold down again to cancel.

Scan Play

The first 10 seconds of each songs (tracks/files) is played in sequence.

Press **[5]** (**SCAN**).

Press again to cancel.

Folder Scan Play (MP3/WMA/AAC)

From the next folder, the first 10 seconds of the first file in each folder is played in sequence.

Hold down **[5]** (**SCAN**) for more than 2 seconds.

Hold down again to cancel.

Troubleshooting

If You Suspect Something Wrong

Check and take steps as described below.





If the described suggestions do not solve the problem, it is recommended to take the unit to your nearest authorized Panasonic Servicenter. The product should be serviced only by qualified personnel. Please refer the checking and the repair to professionals. Panasonic shall not be liable for any accidents arising out of neglect of checking the unit or your own repair after your checking.

Never take measures especially those other than indicated by *italic* letters in "Possible Solution" described below because those are too dangerous for users to handle themselves.

Trouble	Possible Solution
Common	
No power	<ul style="list-style-type: none"> Start the engine. (Or turn the ignition switch to the ACC position.) Verify the wiring. (battery lead, power lead, ground lead, etc.) Fuse blown (Contact the nearest Panasonic Servicenter.) Ask a professional for fuse replacement. Be sure to use the same rated fuse.
No sound	<ul style="list-style-type: none"> Disable the mute function. Verify the wiring. Wait until the dew disappears before turning on the unit.
Noise	<ul style="list-style-type: none"> Make sure that grounding is established properly.
No sound from left, right, front, or rear speaker	<ul style="list-style-type: none"> Adjust the balance and fader. Verify the wiring.
Left and right sounds are reversed	<ul style="list-style-type: none"> Connect the speaker lead correctly.
Disc Player	
No sound, or disc is automatically ejected	<ul style="list-style-type: none"> Load the disc correctly. Clean the disc.
Sound skip, poor sound quality	<ul style="list-style-type: none"> Clean the disc.
Sound skip due to vibration	<ul style="list-style-type: none"> The maximum permissible tilt angle is 30°. Secure the unit.
Disc not ejectable	<ul style="list-style-type: none"> Press [▲]. If the disc is still not ejected, contact the nearest Panasonic Servicenter.

⚠ Warning

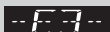
- Do not use the unit in an irregular condition, for example, without sound, or with smoke or a foul smell, which can cause ignition or electric shock. Immediately stop using the unit and consult your dealer.
- Never try to repair the unit by yourself because it is dangerous to do so.

Trouble	Possible Solution
Radio	
Frequent noise	<ul style="list-style-type: none"> Tune in to another station of high-intensity waves. Make sure that the antenna mounted point is grounded properly.
Preset data deleted	<ul style="list-style-type: none"> The preset memory is cleared to return to the original factory setting when the power connector or battery is disconnected.
Error Display Messages (Disc Player)	
	(The disc is ejected automatically.) The disc is dirty or upside down. <ul style="list-style-type: none"> Check the disc.
	(The disc is ejected automatically.) The disc has scratches. <ul style="list-style-type: none"> Check the disc.
	No operation by some cause. <ul style="list-style-type: none"> If normal operation is not restored, consult your dealer or the nearest Servicenter to ask for repairs.
	Cannot read the file <ul style="list-style-type: none"> Check the disc.
	WMA/AAC file can be copyrighted. <ul style="list-style-type: none"> The file protected by copyright is not playable.

CQ-RX400U CQ-RX200U

Note: Refer to the **System Upgrade Guidebook** for error messages regarding optional products.

