

JVC

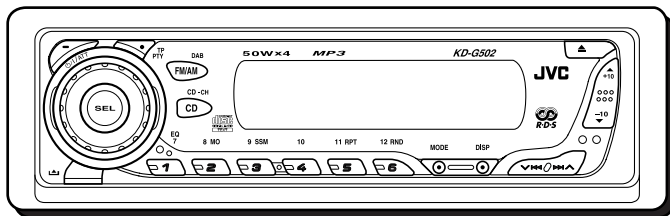

CD RECEIVER

KD-G502

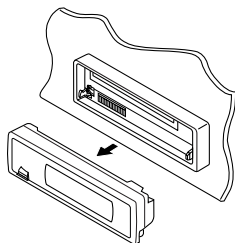

MP3



This unit is equipped with the display demonstration. To cancel it, see page 6.

INSTRUCTIONS

IMPORTANT FOR LASER PRODUCTS

1. CLASS 1 LASER PRODUCT
2. **CAUTION:** Do not open the top cover. There are no user serviceable parts inside the unit; leave all servicing to qualified service personnel.
3. **CAUTION:** Visible and invisible laser radiation when open and interlock failed or defeated. Avoid direct exposure to beam.
4. REPRODUCTION OF LABEL: CAUTION LABEL, PLACED OUTSIDE THE UNIT.

CAUTION: Visible and invisible laser radiation when open and interlock failed or defeated. AVOID DIRECT EXPOSURE TO BEAM. (e)	ADVARSEL: Synlig og usynlig laserstråling når maskinen er åben eller interlocken fejler. Undgå direkte eksponering til stråling. (d)	VARNING: Synlig och osynlig laserstråling när den öppnas och spärren är urkopplad. Betrakta ej strålen. (s)	VARO: Avattassa ja suojalukitus ohitettuna tai viallisena olet alitilina näkyvä ja näkymättömälle lasersäteilylle. Vältä säteeseen kohdistumista suoraan itseesi. (f)
--	---	--	--

How to reset your unit

After detaching the control panel, press the reset button on the panel holder using a ball-point pen or a similar tool. This will reset the built-in microcomputer.

Note:

Your preset adjustments—such as preset channels or sound adjustments—will also be erased.

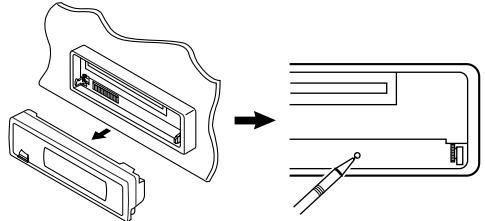

How to use the MODE button

If you press MODE, the unit goes into functions mode, then the number buttons and ▲/▼ buttons work as different function buttons.

Ex.: When number button 2 works as MO (monaural) button.

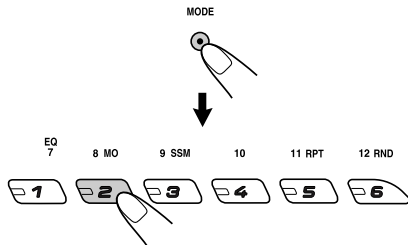

Time countdown indicator

To use these buttons for original functions again after pressing **MODE**, wait for 5 seconds without pressing any of these buttons until the functions mode is cleared.

- Pressing **MODE** again also clears the functions mode.

Note:

For security reasons, a numbered ID card is provided with this unit, and the same ID number is imprinted on the unit's chassis. Keep the card in a safe place, as it will help the authorities to identify your unit if stolen.

Thank you for purchasing a JVC product. Please read all instructions carefully before operation, to ensure your complete understanding and to obtain the best possible performance from the unit.

CONTENTS

How to reset your unit	2	SOUND ADJUSTMENTS	27
How to use the MODE button	2	Selecting preset sound modes	
LOCATION OF THE BUTTONS	4	(C-EQ: custom equalizer)	27
Control panel	4	Adjusting the sound	28
BASIC OPERATIONS	5	OTHER MAIN FUNCTIONS	29
Turning on the power	5	Changing the general settings (PSM)	29
Canceling the display demonstration	6	Detaching the control panel	33
Setting the clock	7	CD CHANGER OPERATIONS	34
RADIO OPERATIONS	8	Playing discs	34
Listening to the radio	8	Selecting the playback modes	37
Storing stations in memory	9	EXTERNAL COMPONENT OPERATIONS ...	38
Tuning in to a preset station	10	Playing an external component	38
RDS OPERATIONS	11	DAB TUNER OPERATIONS	39
What you can do with RDS	11	Tuning in to an ensemble and one of the	
Other convenient RDS functions and		services	39
adjustments	16	Storing DAB services in memory	40
CD OPERATIONS	18	Tuning in to a preset DAB service	41
Playing a CD	18	What you can do more with DAB	42
Locating a track or a particular portion		USING THE REMOTE CONTROLLER	43
on a CD	19	Location of the buttons	44
Selecting CD playback modes	20	TROUBLESHOOTING	45
Playing a CD Text	21	MAINTENANCE	48
Prohibiting disc ejection	21	Handling discs	48
MP3 INTRODUCTION	22	SPECIFICATIONS	49
What is MP3?	22		
How are MP3 files recorded and			
played back?	22		
MP3 OPERATIONS	23		
Playing an MP3 disc	23		
Locating a file or a particular portion			
on a disc	24		
Selecting MP3 playback modes	26		

BEFORE USE

**For safety...*

- Do not raise the volume level too much, as this will block outside sounds, making driving dangerous.
- Stop the car before performing any complicated operations.

**Temperature inside the car...*

If you have parked the car for a long time in hot or cold weather, wait until the temperature in the car becomes normal before operating the unit.



LOCATION OF THE BUTTONS

Control panel

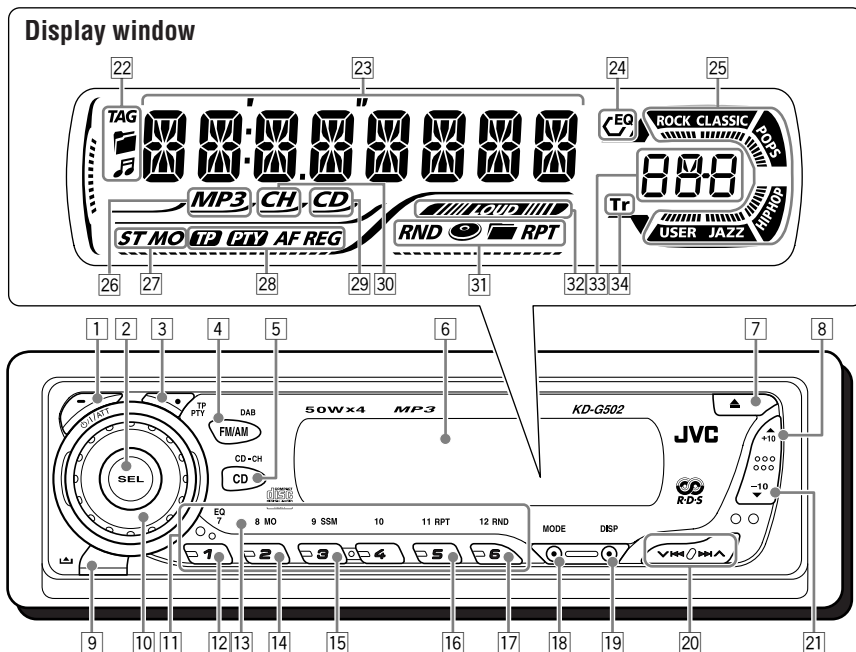

- 1 **⏻/ATT** (standby/on/attenuator) button
- 2 **SEL** (select) button
- 3 **TP PTY** (traffic programme/programme type) button
- 4 **FM/AM DAB** button
- 5 **CD CD-CH** (CD changer) button
- 6 **Display window**
- 7 **▲** (eject) button
- 8 **▲** (up) button
+10 button
- 9 **⏻** (control panel release) button
- 10 **Control dial**
- 11 **Number buttons**
- 12 **EQ** (equalizer) button
- 13 **Remote sensor**
 - You can control this unit with an optionally purchased remote controller.
- 14 **MO** (monaural) button
- 15 **SSM** (Strong-station Sequential Memory) button
- 16 **RPT** (repeat) button
- 17 **RND** (random) button
- 18 **MODE** button
- 19 **DISP** (display) button
- 20 **▼ ◀▶▶ ▲** buttons

- 21 **▼** (down) button
-10 button

Display window

- 22 **Disc information indicators**—TAG (ID3 Tag), (folder), (track/file)
- 23 **Main display**
- 24 **EQ** (equalizer) indicator
- 25 **Sound mode** (C-EQ: custom equalizer) indicators—ROCK, CLASSIC, POPS, HIP HOP, USER
 - also works as level meter during play if the level meter is activated (see page 31).
- 26 **MP3** indicator
- 27 **Tuner reception indicators**—ST (stereo), MO (monaural)
- 28 **RDS indicators**—TP, PTY, AF, REG
- 29 **CD** indicator
- 30 **CH** (CD changer) indicator
- 31 **Playback mode/item indicators**—RND (random), (disc), (folder), RPT (repeat)
- 32 **LOUD** (loudness) indicator
- 33 **Source display**
Volume level indicator
- 34 **Tr** (track) indicator

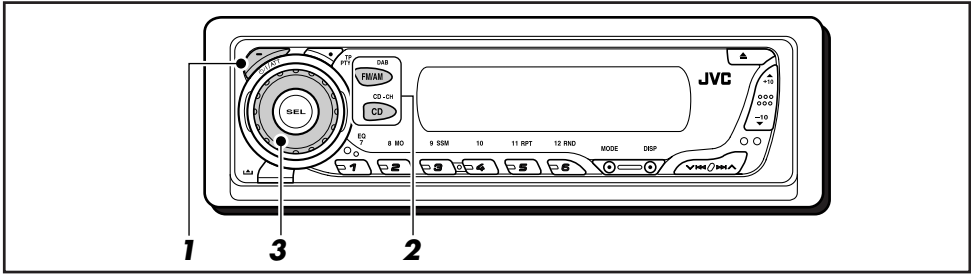

Turning on the power

1 Turn on the power.



Note on One-Touch Operation:

When you select a source in step 2 below, the power automatically comes on. You do not have to press this button to turn on the power.

2 Select the source.

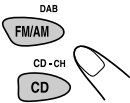

To operate the tuner (FM or AM), see pages 8 – 17.

To play a CD, see pages 18 – 21.

To play an MP3 disc, see pages 23 – 26.

To operate the CD changer, see pages 34 – 37.

To operate the external component (LINE IN), see page 38.

To operate the DAB tuner, see pages 39 – 42.

3 Adjust the volume.

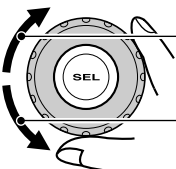

To increase the volume

To decrease the volume

Volume level appears.

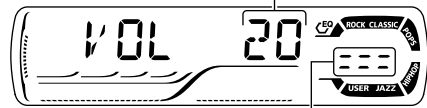

Volume level indicator

4 Adjust the sound as you want. (See pages 27 and 28.)

To drop the volume in a moment

Press **P/ATT** briefly while listening to any source. “ATT” starts flashing on the display, and the volume level will drop in a moment.

To resume the previous volume level, press the button briefly again.

- If you turn the control dial, you can also restore the sound.

To turn off the power

Press and hold **P/ATT** for more than one second.

“SEE YOU” appears, then the unit turns off.

- **If you turn off the power while listening to a disc**, disc play will start from where playback has been stopped previously, next time you turn on the power.

CAUTION on Volume Setting:

Discs produce very little noise compared with other sources. If the volume level is adjusted for the tuner, for example, the speakers may be damaged by the sudden increase in the output level. Therefore, lower the volume before playing a disc and adjust it as required during playback.

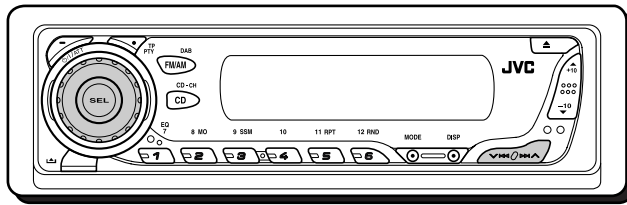

Canceling the display demonstration

When shipped from the factory, display demonstration has been activated, and starts automatically when no operations are done for about 20 seconds.

- It is recommended to cancel the display demonstration before you use the unit for the first time.

To cancel the display demonstration, follow the procedure below:

- 1** Press and hold SEL (select) for more than 2 seconds so that one of the PSM items appears on the display. (PSM: see pages 29 and 30.)



- 2** Select "DEMO" if not shown on the display.



- 3** Select "DEMO OFF."

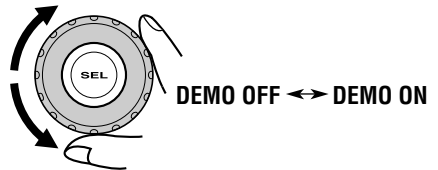

- 4** Finish the setting.



To activate the display demonstration, repeat the same procedure and select "DEMO ON" in step 3.

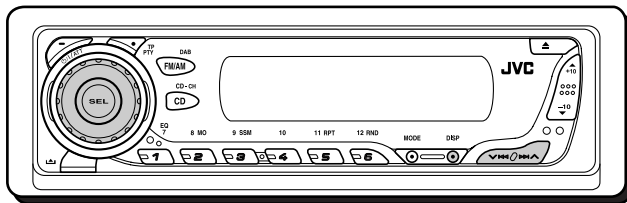

Setting the clock

You can also set the clock system to either 24 hours or 12 hours.

- 1 Press and hold SEL (select) for more than 2 seconds so that one of the PSM items appears on the display. (PSM: see pages 29 and 30.)



2 Set the hour.

- 1 Select "CLOCK H" (hour) if not shown on the display.
- 2 Adjust the hour.

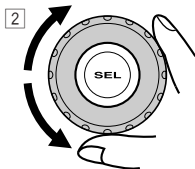
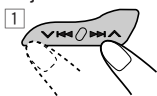

3 Set the minute.

- 1 Select "CLOCK M" (minute).
- 2 Adjust the minute.

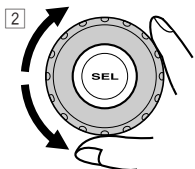
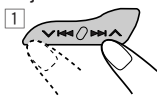

4 Set the clock system.

- 1 Select "24H/12H."
- 2 Select "24H" or "12H."

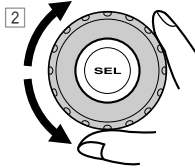
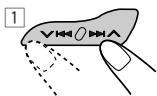

5 Finish the setting.

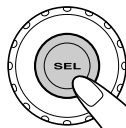

To check the current clock time or change the display mode

DISP



Press DISP (display) repeatedly. Each time you press the button, the display changes as follows:

- During AM and FM non-RDS Station operation:

Frequency ↔ Clock

- During FM RDS Station operation:

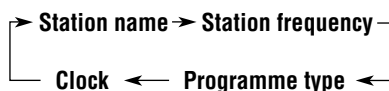

- During disc operation:

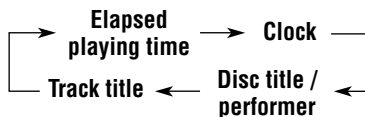

Notes:

- While playing a conventional CD, "NO NAME" appears for the disc title/performer and the track title.
- For indication change while playing a CD Text or an MP3 disc, see also pages 21 and 24.

- During external component operation:

LINE IN ↔ Clock

- During power off:

The power turns on and the clock time is shown for 5 seconds, then the power turns off.



RADIO OPERATIONS

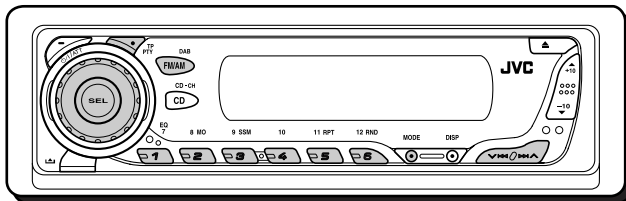

Listening to the radio

You can use either automatic searching or manual searching to tune in to a particular station.

Searching for a station automatically:

Auto search

1 Select the band (FM1 – 3, AM).

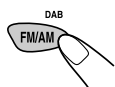

Each time you press the button, the band changes as follows:

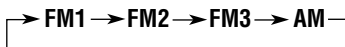

Selected band appears.



Lights up when receiving an FM stereo broadcast with sufficient signal strength.

Note:

This receiver has three FM bands (FM1, FM2, FM3). You can use any one of them to listen to an FM broadcast.

2 Start searching for a station.

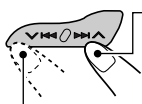

To search for stations of higher frequencies

To search for stations of lower frequencies

When a station is received, searching stops.

To stop searching before a station is received, press the same button you have pressed for searching.

Searching for a station manually: Manual search

1 Select the band (FM1 – 3, AM).

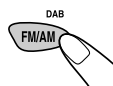

Each time you press the button, the band changes as follows:

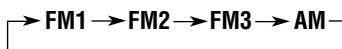

Note:

This receiver has three FM bands (FM1, FM2, FM3). You can use any one of them to listen to an FM broadcast.

2 Press and hold >>> ^ or v <<< until "M" (manual) starts flashing on the display.

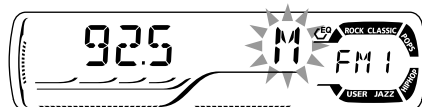
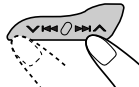

3 Tune in to a station you want while “M” (manual) is still flashing.



To tune in to stations of higher frequencies

To tune in to stations of lower frequencies

- If you release your finger from the button, the manual mode will automatically turn off after 5 seconds.
- If you hold down the button, the frequency keeps changing (in 50 kHz intervals for FM and 9 kHz for AM—MW/LW) until you release the button.

When an FM stereo broadcast is hard to receive:

MODE



- 1 Press MODE to enter the functions mode while listening to an FM stereo broadcast.

8 MO



- 2 Press MO (monaural), while “MODE” is still flashing on the display, so that “MONO” appears on the display. Each time you press the button, monaural mode turns on and off alternately.



MO (monaural) indicator

When the MO indicator is lit on the display, the sound you hear becomes monaural but the reception will be improved.

Storing stations in memory

You can use one of the following two methods to store broadcasting stations in memory.

- Automatic preset of FM stations: SSM (Strong-station Sequential Memory)
- Manual preset of both FM and AM stations

FM station automatic preset: SSM

You can preset 6 local FM stations in each FM band (FM1, FM2, and FM3).

1 Select the FM band (FM1 – 3) you want to store FM stations into.



Each time you press the button, the band changes as follows:

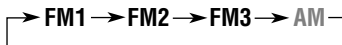

2 Press MODE to enter the functions mode.

MODE



3 Press and hold SSM for about 2 seconds.

9 SSM

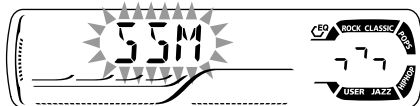
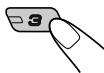

“SSM” flashes, then disappears when automatic preset is over.

Local FM stations with the strongest signals are searched and stored automatically in the band number you have selected (FM1, FM2, or FM3). These stations are preset in the number buttons—No.1 (lowest frequency) to No.6 (highest frequency).

When automatic preset is over, the station stored in number button 1 will be automatically tuned in.



Manual preset

You can preset up to 6 stations in each band (FM1, FM2, FM3, and AM) manually.

Ex.: Storing FM station of 92.5 MHz into the preset number 1 of the FM1 band.

1 Select the band (FM1 – 3, AM) you want to store stations into (in this example, FM1).

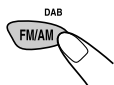

Each time you press the button, the band changes as follows:

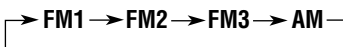

2 Tune in to a station (in this example, of 92.5 MHz).

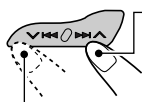

To tune in to stations of higher frequencies

To tune in to stations of lower frequencies



3 Press and hold the number button (in this example, 1) for more than 2 seconds.

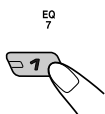

Preset number flashes for a while.

4 Repeat the above procedure to store other stations into other preset numbers.

Notes:

- A previously preset station is erased when a new station is stored in the same preset number.
- Preset stations are erased when the power supply to the memory circuit is interrupted (for example, during battery replacement). If this occurs, preset the stations again.

Tuning in to a preset station

You can easily tune in to a preset station. Remember that you must store stations first. If you have not stored them yet, see “Storing stations in memory” on pages 9 and 10.

1 Select the band (FM1 – 3, AM).

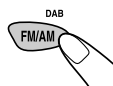

Each time you press the button, the band changes as follows:

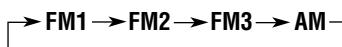

2 Select the number (1 – 6) for the preset station you want.

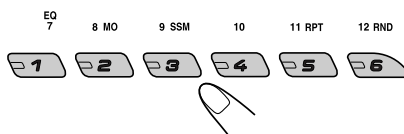



What you can do with RDS

RDS (Radio Data System) allows FM stations to send an additional signal along with their regular programme signals. For example, the stations send their station names, as well as information about what type of programme they broadcast, such as sports or music, etc.

Another advantage of RDS function is called “Enhanced Other Networks.” By using the Enhanced Other Networks data sent from a station, you can tune in to a different station of a different network broadcasting your favorite programme or traffic announcement while listening to another programme or to another source such as CD.

By receiving the RDS data, this unit can do the following:

- Tracing the same programme automatically (Network-Tracking Reception)
- Standby Reception of TA (Traffic Announcement) or your favorite programme
- PTY (Programme Type) search
- Programme search
- And some other functions

Tracing the same programme automatically (Network-Tracking Reception)

When driving in an area where FM reception is not good, the tuner built in this unit automatically tunes in to another RDS station, broadcasting the same programme with stronger signals. So, you can continue to listen to the same programme in its finest reception, no matter where you drive. (See the illustration on page 17.)

Two types of the RDS data are used to make Network-Tracking Reception work correctly —PI (Programme Identification) and AF (Alternative Frequency).

Without receiving these data correctly from the RDS station you are listening to, Network-Tracking Reception will not operate.

To use Network-Tracking Reception

You can select the different modes of network-tracking reception to continue listening to the same programme in its finest reception. When shipped from the factory, “AF” is selected.

- **AF:** Network-Tracking Reception is activated with Regionalization set to “off.”
With this setting, the unit switches to another station within the same network when the received signals from the current station become weak. (In this mode, the programme may differ from the one currently received.)
The AF indicator lights up but the REG indicator does not.
- **AF REG:** Network-Tracking Reception is activated with Regionalization set to “on.”
With this setting, the unit switches to another station, within the same network, broadcasting the same programme when the received signals from the current station become weak.
Both the AF indicator and the REG indicator light up.
- **OFF:** Network-Tracking Reception is deactivated.
Neither the AF indicator nor the REG indicator lights up.



AF and REG indicators

Note:

If a DAB tuner is connected and Alternative Reception (for DAB services) is activated, Network-Tracking Reception is also activated (“AF”) automatically. On the other hand, Network-Tracking Reception cannot be deactivated without deactivating Alternative Reception. (See page 42.)



- 1 Press and hold SEL (select) for more than 2 seconds so that one of the PSM items appears on the display. (PSM: see pages 29 and 30.)**



- 2 Select “AF-REG” (alternative frequency/regionalization reception) if not shown on the display.**



- 3 Select the desired mode—“AF,” “AF REG,” or “OFF.”**

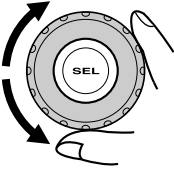

- 4 Finish the setting.**



Using TA Standby Reception

TA Standby Reception allows the unit to switch temporarily to Traffic Announcement (TA) from the current source (another FM station, CD, or other connected components).

- *TA Standby Reception will not work if you are listening to an AM station.*

Press TP PTY to activate TA Standby Reception.



- **When the current source is FM,** the TP indicator either lights up or flashes.

- If the TP indicator lights up, TA Standby Reception is activated.

If a station starts broadcasting a traffic announcement, “TRAFFIC” appears on the display, and this unit automatically tunes in to the station. The volume changes to the preset TA volume level (see page 16) and the traffic announcement can be heard.

- If the TP indicator flashes, TA Standby Reception is not yet activated since the station being received does not provide the signals used for TA Standby Reception.

To activate TA Standby Reception, you need to tune in to another station providing these signals. Press ►►| ▲ or ▼ |◄◄ to search for such a station.

When a station providing these signals is tuned in, the TP indicator stops flashing and remains lit. Now TA Standby Reception is activated.

- **When the current source is other than FM,** the TP indicator lights up.

If a station starts broadcasting a traffic announcement, “TRAFFIC” appears on the display, and this unit automatically changes the source and tunes in to the station.

To deactivate the TA Standby Reception, press TP PTY again. The TP indicator disappears.



Using PTY Standby Reception

PTY Standby Reception allows the unit to switch temporarily to your favorite programme (PTY: Programme Type) from the current source (another FM station, CD, or other connected components).

- *PTY Standby Reception will not work if you are listening to an AM station.*

You can select your favorite programme type for PTY Standby Reception.

When shipped from the factory, PTY Standby Reception is turned off. ("OFF" is selected for PTY Standby Reception.)

- 1 Press and hold SEL (select) for more than 2 seconds so that one of the PSM items appears on the display. (PSM: see pages 29 and 30.)**



- 2 Select "PTY STBY" (standby) if not shown on the display.**



- 3 Select one of the twenty-nine PTY codes. (See page 17.)**

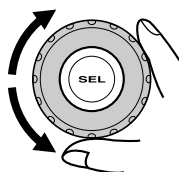

Selected code name appears on the display and is stored into memory.

- 4 Finish the setting.**

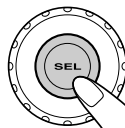

- **When the current source is FM, the PTY indicator either lights up or flashes.**

- If the PTY indicator lights up, PTY Standby Reception is activated.

If a station starts broadcasting the selected PTY programme, this unit automatically tunes in to the station.

- If the PTY indicator flashes, PTY Standby Reception is not yet activated since the station being received does not provide the signals used for PTY Standby Reception.

To activate PTY Standby Reception, you need to tune in to another station providing these signals. Press ►►| ▲ or ▼ |◄◄ to search for such a station.

When a station providing these signals is tuned in, the PTY indicator stops flashing and remains lit. Now PTY Standby Reception is activated.

- **When the current source is other than FM, the PTY indicator lights up.**

If a station starts broadcasting the selected PTY programme, this unit automatically changes the source and tunes in to the station.

To deactivate the PTY Standby Reception, select "OFF" in step 3 on the left column. The PTY indicator disappears.



Searching your favorite programme

You can search any one of the PTY codes. In addition, you can store your 6 favorite programme types in the number buttons. When shipped from the factory, the following 6 programme types have been stored in the number buttons (1 to 6).

To store your favorite programme types, see below.

To search your favorite programme type, see page 15.

1	2	3
POP M	ROCK M	EASY M
4	5	6
CLASSICS	AFFAIRS	VARIED

To store your favorite programme types

- 1 Press and hold TP PTY for more than 2 seconds while listening to an FM station.



The last selected PTY code appears.

- 2 Select one of the twenty-nine PTY codes. (See page 17.)

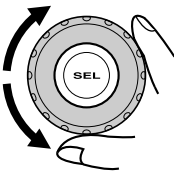

Selected code name appears on the display.

- 3 Press and hold the number button for more than 2 seconds to store the PTY code selected into the preset number you want.

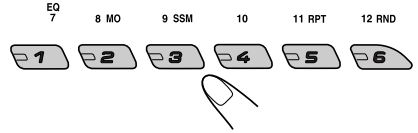

Selected PTY code and "MEMORY" appear alternately for a while.



- 4 Press and hold TP PTY for more than 2 seconds to exit from this mode.





To search your favorite programme type

- 1 Press and hold TP PTY for more than 2 seconds while listening to an FM station.



The last selected PTY code appears.

- 2 To select one of your favorite programme type

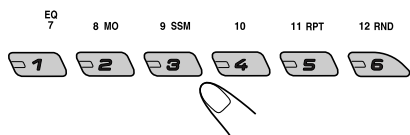

or

To select any one of the twenty-nine PTY codes

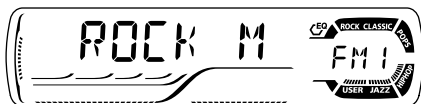
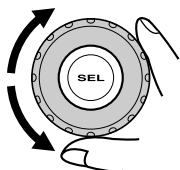

Ex.: When "ROCK M" is selected

- 3 Press $\blacktriangleright\blacktriangleleft$ \wedge or \vee $\blacktriangleleft\blacktriangleright$ to start PTY search for your favorite programme.



- If there is a station broadcasting a programme of the same PTY code as you selected, that station is tuned in.
- If there is no station broadcasting a programme of the same PTY code as you selected, the station will not change.

Note:

In some areas, the PTY search will not work correctly.



Other convenient RDS functions and adjustments

Automatic selection of the station when using the number buttons

Usually when you press the number button, the preset station is tuned in.

However, when the preset station is an RDS station, something different will happen. If the signals from that preset station are not sufficient for good reception, this unit, using the AF data, tunes in to another frequency broadcasting the same programme as the original preset station is broadcasting. (Programme search)

- The unit takes some time to tune in to another station using programme search.

To activate programme search, follow the procedure below.

- See also “Changing the general settings (PSM)” on page 29.

- 1 Press and hold SEL (select) for more than 2 seconds so that one of the PSM items appears on the display.
- 2 Press ►►| ▲ or ▼ |◄◄ to select “P(Programme)-SEARCH.”
- 3 Turn the control dial clockwise to select “ON.” Now programme search is activated.
- 4 Press SEL (select) to finish the setting.

To cancel programme search, repeat the same procedure and select “OFF” in step 3 by turning the control dial counterclockwise.

Setting the TA volume level

You can preset the volume level for TA Standby Reception. When a traffic programme is received, the volume level automatically changes to the preset level.

- See also “Changing the general settings (PSM)” on page 29.

- 1 Press and hold SEL (select) for more than 2 seconds so that one of the PSM items appears on the display.
- 2 Press ►►| ▲ or ▼ |◄◄ to select “TA VOL” (volume).
- 3 Turn the control dial to set to the desired volume.
You can set it from “VOL 00” to “VOL 30” or “VOL 50” (depending on the amplifier gain control setting: see page 32).
- 4 Press SEL (select) to finish the setting.

Automatic clock adjustment

When shipped from the factory, the clock built in this unit is set to be readjusted automatically using the CT (Clock Time) data in the RDS signal.

If you do not want to use automatic clock adjustment, follow the procedure below.

- See also “Changing the general settings (PSM)” on page 29.

- 1 Press and hold SEL (select) for more than 2 seconds so that one of the PSM items appears on the display.
- 2 Press ►►| ▲ or ▼ |◄◄ to select “AUTO ADJ” (adjustment).
- 3 Turn the control dial counterclockwise to select “OFF.”
Now automatic clock adjustment is canceled.
- 4 Press SEL (select) to finish the setting.

To reactivate clock adjustment, repeat the same procedure and select “ON” in step 3 by turning the control dial clockwise.

Note:

You must stay tuned to the same station for more than 2 minutes after setting “AUTO ADJ” to “ON.” Otherwise, the clock time will not be adjusted. (This is because the unit takes up to 2 minutes to capture the CT data in the RDS signal.)



PTY codes

NEWS:	News	SOCIAL:	Programmes on social activities
AFFAIRS:	Topical programmes expanding on current news or affairs	RELIGION:	Programmes dealing with any aspect of belief or faith, or the nature of existence or ethics
INFO:	Programmes which impart advice on a wide variety of topics	PHONE IN:	Programmes where people can express their views either by phone or in a public forum
SPORT:	Sport events	TRAVEL:	Programmes about travel destinations, package tours, and travel ideas and opportunities
EDUCATE:	Educational programmes	LEISURE:	Programmes concerned with recreational activities such as gardening, cooking, fishing, etc.
DRAMA:	Radio plays	JAZZ:	Jazz music
CULTURE:	Programmes on national or regional culture	COUNTRY:	Country music
SCIENCE:	Programmes on natural science and technology	NATION M:	Current popular music from another nation or region, in that country's language
VARIED:	Other programmes like comedies or ceremonies	OLDIES:	Classic pop music
POP M:	Pop music	FOLK M:	Folk music
ROCK M:	Rock music	DOCUMENT:	Programmes dealing with factual matters, presented in an investigative style
EASY M:	Easy-listening music		
LIGHT M:	Light music		
CLASSICS:	Classical music		
OTHER M:	Other music		
WEATHER:	Weather information		
FINANCE:	Reports on commerce, trading, the Stock Market, etc.		
CHILDREN:	Entertainment programmes for children		

The same programme can be received on different frequencies.

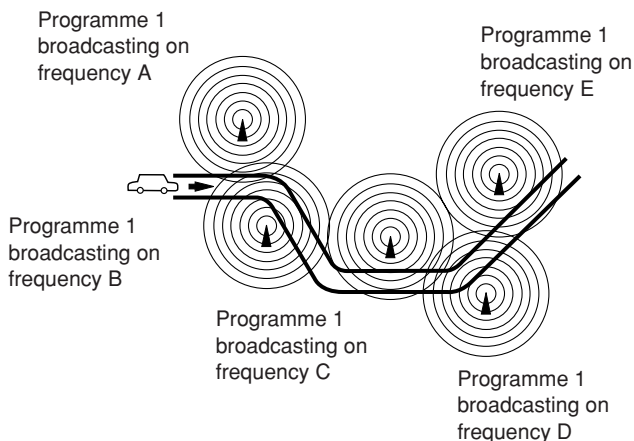



CD OPERATIONS

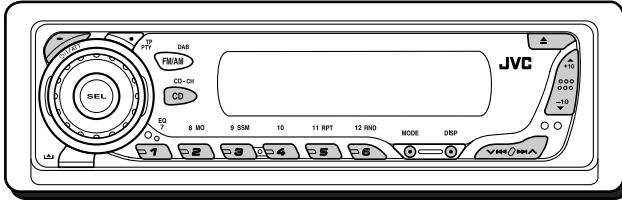

Refer "MP3 OPERATIONS" on pages 23 to 26 for operating MP3 discs.

The display changes to show the following:

Playing a CD

Current source indication

1 Open the control panel.

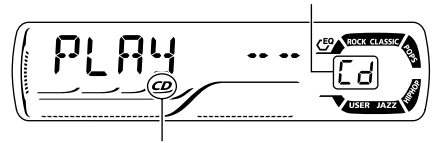

CD indicator

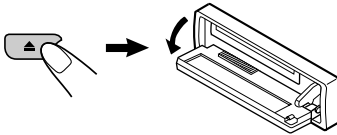

Total playing time of the inserted disc Total track number of the inserted disc

Note on One-Touch Operation:
When a CD is already in the loading slot, pressing CD CD-CH turns on the unit and starts playback automatically.

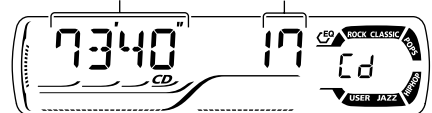

Current track number

2 Insert a CD into the loading slot.

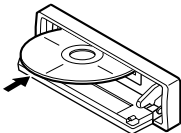

The unit turns on, draws the CD and starts playback automatically.

Elapsed playing time number

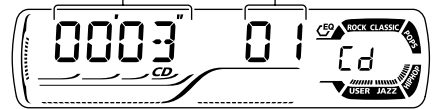

3 Close the control panel by hand.

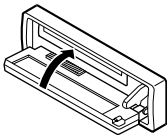

All tracks will be played repeatedly until you stop playback.

Notes:

- When a CD is inserted upside down, the CD automatically ejects (if the control panel is open). If the control panel is closed, the source changes to the previously selected source, "PLEASE" and "EJECT" appear alternately on the display.
- If there is no CD in the loading slot, you cannot select CD as the source. "NO DISC" appears on the display.
- If the current disc is a CD Text, disc title/performer and then track title will automatically appear.



To stop play and eject the CD

Press **▲**.
CD play stops and the control panel flips down. The CD automatically ejects from the loading slot. The source changes to the previously selected source.

- If you change the source, CD play also stops (without ejecting the CD). Next time you select “CD” as the source, CD play starts from where playback has been stopped previously.

Notes:

- *If the ejected disc is not removed for about 15 seconds, the disc is automatically inserted again into the loading slot to protect it from dust. (Disc play will not start this time.)*
- *You can eject the disc even when the unit is turned off.*

Locating a track or a particular portion on a CD

To fast-forward or reverse the track

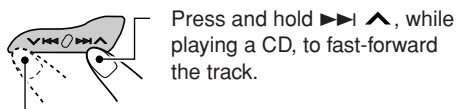

Press and hold **▶▶** **▲**, while playing a CD, to fast-forward the track.

Press and hold **▼** **◀◀**, while playing a CD, to reverse the track.

To go to the next or previous tracks

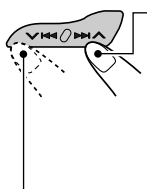

Press **▶▶** **▲** briefly, while playing a CD, to go ahead to the beginning of the next track. Each time you press the button consecutively, the beginning of the next tracks is located and played back.

Press **▼** **◀◀** briefly, while playing a CD, to go back to the beginning of the current track. Each time you press the button consecutively, the beginning of the previous tracks is located and played back.

To go to a particular track directly

Press the number button corresponding to the track number to start its playback.

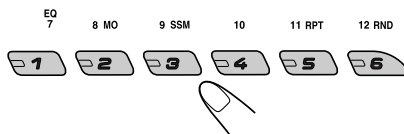

- To select a track number from 1 – 6:
Press 1 (7) – 6 (12) briefly.
- To select a track number from 7 – 12:
Press and hold 1 (7) – 6 (12) for more than one second.

To go to a track quickly (+10 and -10 buttons)

- 1 Press **MODE** to enter the functions mode while playing a CD.

MODE



- 2 Press **+10** or **-10**.

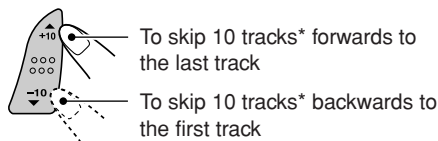

- * First time you press **+10** or **-10** button, the track skips to the nearest higher or lower track with a track number of multiple ten (ex. 10th, 20th, 30th).

Then each time you press the button, you can skip 10 tracks (see “How to use the **+10** and **-10** buttons” on page 20).

- After the last track, the first track will be selected, and vice versa.



How to use the +10 and -10 buttons

- Ex. 1: To select track number 32 while playing track number 6

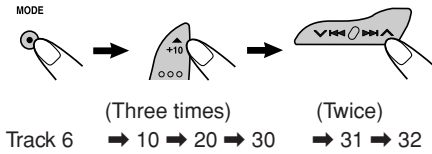

- Ex. 2: To select track number 8 while playing track number 36

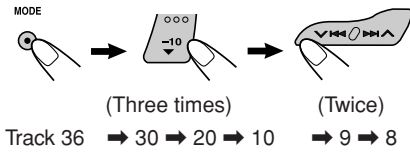

To play back tracks repeatedly (Track Repeat Play)

You can play back the current track repeatedly.

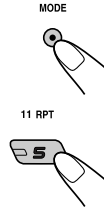

- 1 Press MODE to enter the functions mode while playing a CD.
- 2 Press RPT (repeat), while "MODE" is still flashing on the display, so that "TRK RPT" appears on the display. Each time you press the button, track repeat play mode turns on and off alternately.

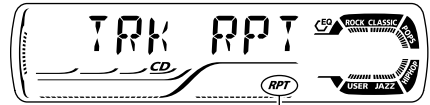

RPT indicator

When track repeat play is turned on, the RPT indicator lights up on the display. The current track starts playing repeatedly.

Selecting CD playback modes

To play back tracks at random (Disc Random Play)

You can play back all tracks on the CD at random.

- 1 Press MODE to enter the functions mode while playing a CD.
- 2 Press RND (random), while "MODE" is still flashing on the display, so that "DISC RND" appears on the display. Each time you press the button, disc random play mode turns on and off alternately.

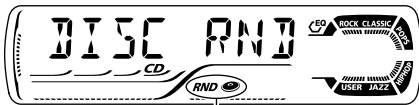

RND and (disc) indicators

When disc random play is turned on, the RND and (disc) indicators light up on the display. A track randomly selected starts playing.



Playing a CD Text

In a CD Text, some information about the disc (its disc title, performer, and track title) is recorded. This CD Text information will be shown automatically when you play a CD Text.

To change the CD Text information manually, select text display mode while playing a CD Text.

DISP



Press DISP (display) repeatedly. Each time you press the button, the display changes as follows:

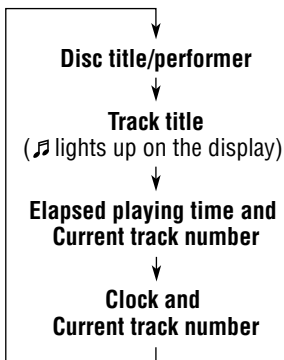

Notes:

- The display shows up to 8 characters at one time and scrolls if there are more than 8 characters. See also “To select the scroll mode—SCROLL” on page 31. Some characters or symbols will not be shown (and be blanked) on the display. (Ex. “ABC&!d#” ⇔ “ABCA D ”)
- When you press DISP (display) while playing a conventional CD, “NO NAME” appears for the disc title/performer and the track title.
- When track title is shown, the Tr indicator and current track number also appear on the right side of the display.

Prohibiting disc ejection

You can prohibit disc ejection and can lock a disc in the loading slot.

While pressing CD CD-CH, press and hold /I/ATT for more than 2 seconds.

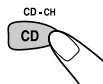

“NO EJECT” flashes on the display for about 5 seconds, and the disc is locked and cannot be ejected.



To cancel the prohibition and unlock the disc

While pressing CD CD-CH, press and hold /I/ATT again for more than 2 seconds. “EJECT OK” flashes on the display for about 5 seconds, and the disc is unlocked.





MP3 INTRODUCTION

What is MP3?

MP3 is an abbreviation of Motion Picture Experts Group (or MPEG) Audio Layer 3. MP3 is simply a file format with a data compression ratio of 1:10 (128 Kbps*).

* *Bit rate is the average number of bits that one second of audio data will consume. The unit used is Kbps. To get a better audio quality, choose a higher bit rate. The most popular bit rate for encoding is 128 Kbps.*

- **For details information about the MP3 discs, refer to “A Guide to MP3/WMA” (separate volume).**

Compatible with ID3 Tag

Extra information data such as album title, performer name, song title, recording year, music genre and a brief comment can be stored within an MP3 file.

This unit can show both ID3v1 (Version 1) and ID3v2 (Version 2) tags on the display. (See page 24.)

- Some characters cannot be shown correctly.
- If both ID3v1 and ID3v2 are recorded on a disc, ID3v2 information will be shown.

How are MP3 files recorded and played back?

MP3 “files (tracks)” can be recorded in “folders” —in PC terminology.

During recording, the files and folders can be arranged in a way similar to arranging files and folders of computer data.

“Root” is similar to the root of a tree. Every file and folder can be linked to and be accessed from the root.

The illustration below shows an example of how MP3 files are recorded on a CD-R or CD-RW, how they are played back, and how they are searched for on this unit.

Notes:

- *This unit can read a CD-ROM containing MP3 files. However, if non-MP3 files are recorded together with MP3 files, this unit will take a longer time to scan the disc. It may also cause the unit to malfunction.*
- *This unit cannot read or play an MP3 file without the extension code <.mp3>.*
- *This unit is not compatible with MP3 file encoded with Layer 1 and Layer 2 formats.*
- *This unit is not compatible with Playlist**.*

** *A playlist is a simple text file, used on a PC, which enables users to make their own playback order without physically rearranging the files.*

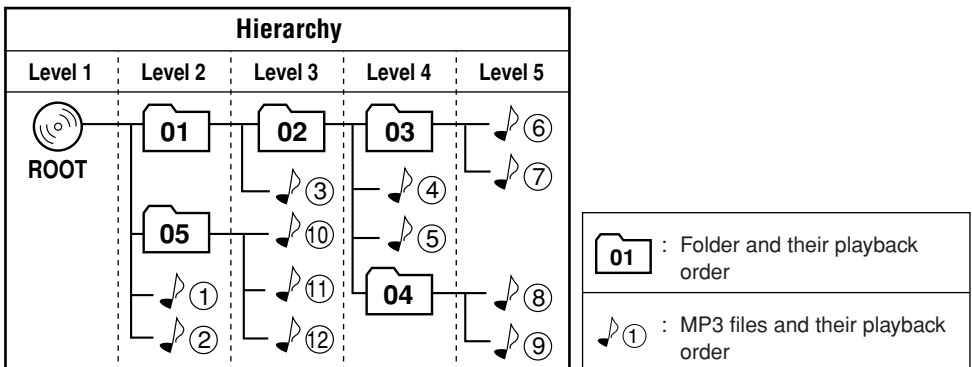

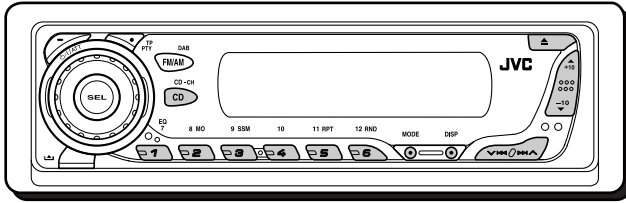

Refer also to "CD OPERATIONS" on pages 18 to 21.

Playing an MP3 disc

1 Open the control panel.

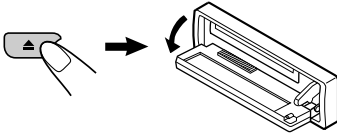

Note on One-Touch Operation:

When a disc is already in the loading slot, pressing CD CD-CH turns on the unit and starts playback automatically.

2 Insert an MP3 disc into the loading slot.

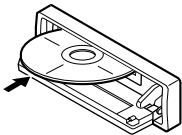

The unit turns on, draws the disc and starts playback automatically.

3 Close the control panel by hand.

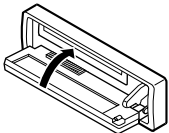

All files will be played repeatedly until you stop playback.

The display changes to show the following:

Current source indication

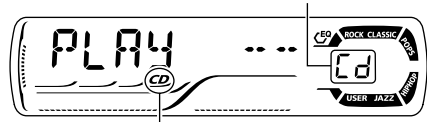

CD indicator



Total folder number

Total file number

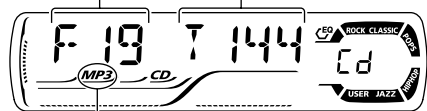

MP3 indicator

Ex.: When the disc contains 19 folders and 144 MP3 files

Notes:

- MP3 discs require a longer readout time. (It differs due to the complexity of the folder/file configuration.)
- When playback starts, folder and file names (or ID3 tags) will automatically appears. (See also page 24.)
- If you change the source or turn the power off, disc playback stops (without ejecting the disc). Next time you select the CD player as the source or turn the power on, disc play starts from where playback has been stopped previously.

To stop play and eject the disc

Press **▲**.
 Playback stops and the control panel flips down.
 The disc automatically ejects from the loading slot.

To change the display information

While playing back an MP3 file, you can change the MP3 disc information shown on the display.



Press DISP (display) repeatedly. Each time you press the button, the display changes to show the following:

- When “TAG DISP” is set to “TAG ON” (initial setting: see page 32)

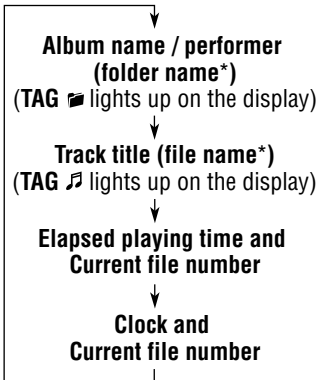

* If an MP3 file does not have ID3 tags, folder name and file name appear. In this case, the TAG indicator will not light up on the display.

- When “TAG DISP” is set to “TAG OFF”

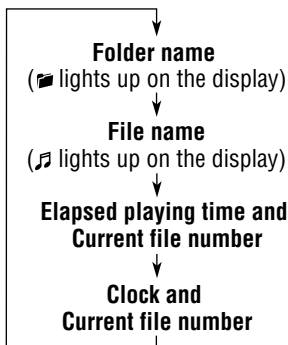

Notes:

- The display shows up to 8 characters at a time and scrolls if there are more than 8 characters. See also “To select the scroll mode—SCROLL” on page 31.
- When folder or file name is shown, current folder number or the Tr indicator and current file number also appear on the right side of the display.

Locating a file or a particular portion on a disc

To fast-forward or reverse the file

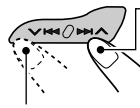

Press and hold **▶▶** **▲** while playing a disc, to fast-forward the file.

Press and hold **◀◀** **▼** while playing a disc, to reverse the file.

Note:

During this operation, you can only hear intermittent sounds. (The elapsed playing time also changes intermittently on the display.)

To skip to the next or previous files

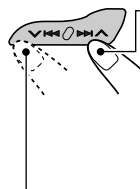

Press **▶▶** **▲** briefly while playing, to skip ahead to the beginning of the next file.

Each time you press the button consecutively, the beginning of the next files is located and played back.

Press **◀◀** **▼** briefly, while playing, to skip back to the beginning of the current file.

Each time you press the button consecutively, the beginning of the previous files is located and played back.

To go to a particular file quickly within the current folder (+10 and -10 buttons)

- 1 Press MODE to enter the functions mode while playing a disc.



- 2 Press +10 or -10.

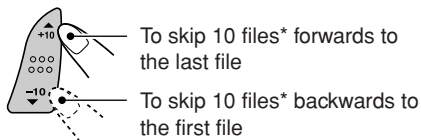

* First time you press +10 or -10 button, the file skips to the nearest higher or lower file with a file number of multiple ten (ex. 10th, 20th, 30th).

Then each time you press the button, you can skip 10 files (see "How to use the +10 and -10 buttons" below).

- After the last file, the first file will be selected, and vice versa.

How to use the +10 and -10 buttons

- Ex. 1: To select file number 32 while playing file number 6



- Ex. 2: To select file number 8 while playing file number 36

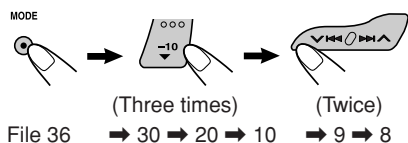

To go to a particular folder directly

IMPORTANT:

To directly select the folders using the number button(s), it is required that folders are assigned 2 digit numbers at the beginning of their folder names. (This can only be done during the recording of CD-Rs or CD-RWs.)

Ex.: If folder name is "01 ABC"

→ Press 1 to go to Folder 01 ABC.

If folder name is "1 ABC," pressing 1 does not work.

If folder name is "12 ABC"

→ Press and hold 6 (12) to go to Folder 12 ABC.

Press the number button corresponding to the folder number to start playing the first file in the selected folder.

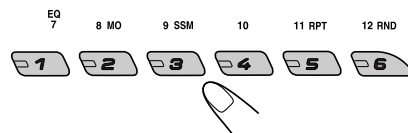

- To select a folder number from 01 – 06: Press 1 (7) – 6 (12) briefly.
- To select a folder number from 07 – 12: Press and hold 1 (7) – 6 (12) for more than one second.

Notes:

- If  indicator flashes on the display after you have selected a folder, it means that the folder does not contain any MP3 files.
- You cannot directly select a folder with a number greater than 12.

To select a particular file in a folder, press

▶▶| ▲ or ▼ |◀◀ after selecting the folder.

To skip to the next or previous folder

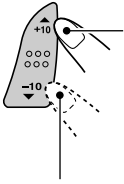

Press ▲ (up) while playing an MP3 disc to skip to the next folder. Each time you press the button consecutively, the next folder is located (and the first file in the folder starts playing, if recorded).

Press ▼ (down) while playing an MP3 disc to skip back to the previous folder.

Each time you press the button consecutively, the previous folder is located (and the first file in the folder starts playing, if recorded).

Note:

If the folder does not contain any MP3 files, it is skipped.

Selecting MP3 playback modes

To play back files at random (Folder Random/Disc Random Play)

You can play back all files of the current folder or all files on the MP3 disc at random.

MODE



1 Press MODE to enter the functions mode while playing an MP3 disc.

12 RND

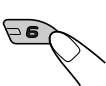

2 Press RND (random), while “MODE” is still flashing on the display, so that “FLDR RND” or “DISC RND” appears on the display. Each time you press the button, the random play mode changes as follows:

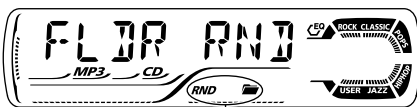

RND and (folder) indicators
Ex.: When you select “FLDR RND”

Mode	Active indicator	Plays at random
FLDR RND	RND and indicators light up.	All files of the current folder, then files of the next folder and so on.
DISC RND	RND and indicators light up.	All files on the disc.

To play back files repeatedly (Track Repeat/Folder Repeat Play)

You can play back the current file or all the files in the current folder repeatedly.

MODE



1 Press MODE to enter the functions mode while playing an MP3 disc.

11 RPT



2 Press RPT (repeat), while “MODE” is still flashing on the display, so that “TRK RPT” or “FLDR RPT” appears on the display. Each time you press the button, the repeat play mode changes as follows:

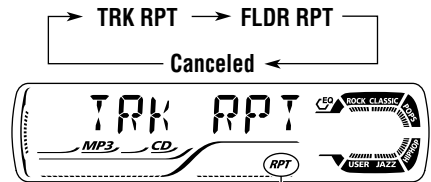

Ex.: When you select “TRK RPT”

Mode	Active indicator	Plays repeatedly
TRK RPT	RPT indicator lights up.	The current (or specified) file.
FLDR RPT	and RPT indicators light up.	All files of the current (or specified) folder.

SOUND ADJUSTMENTS



Selecting preset sound modes (C-EQ: custom equalizer)

You can select a preset sound mode (C-EQ: custom equalizer) suitable to the music genre.

- There is a time limit in doing the following procedure. If the setting is canceled before you finish, start from step 1 again.

1 Press MODE to enter the functions mode.

MODE



2 Press EQ (equalizer) while "MODE" is still flashing on the display.

EQ

You can confirm the current sound mode.

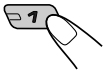

3 Select the sound mode you want.

EQ

Each time you press the button, the sound modes change as follows:

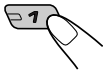

USER	ROCK
JAZZ	CLASSIC
HIP HOP	POPS

Indication pattern changes for each sound mode except for "USER."



Ex.: When you select "ROCK"

Indication	For:	Preset values		
		BAS	TRE	LOUD
USER	(Flat sound)	00	00	OFF
ROCK	Rock or disco music	+03	+01	ON
CLASSIC	Classical music	+01	-02	OFF
POPS	Light music	+04	+01	OFF
HIP HOP	Funk or rap music	+02	00	ON
JAZZ	Jazz music	+02	+03	OFF

Note:

You can adjust each sound mode to your preference. Once you make an adjustment, it is automatically stored for the currently selected sound mode. See "Adjusting the sound" on page 28.



Adjusting the sound

You can adjust the sound characteristics to your preference.

1 Select the item you want to adjust.



Each time you press the button, the adjustable items change as follows:

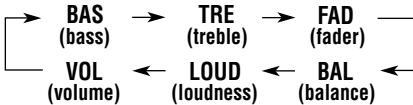

Indication	To do:	Range
BAS* ¹	Adjust the bass.	-06 (min.) +06 (max.)
TRE* ¹	Adjust the treble.	-06 (min.) +06 (max.)
FAD* ²	Adjust the front and rear speaker balance.	R06 (Rear only) F06 (Front only)
BAL	Adjust the left and right speaker balance.	L06 (Left only) R06 (Right only)
LOUD* ¹	Boost low and high frequencies to produce a well-balanced sound at low volume level.	LOUD ON LOUD OFF
VOL* ³	Adjust the volume.	00 (min.) 30 or 50 (max.)* ⁴

*¹ When you adjust the bass, treble, or loudness, the adjustment you have made is stored for the currently selected sound mode (C-EQ) including "USER."

*² If you are using a two-speaker system, set the fader level to "00."

*³ Normally the control dial works as the volume control. So you do not have to select "VOL" to adjust the volume level.

*⁴ Depending on the amplifier gain control setting. (See page 32 for details.)

2 Adjust the setting.

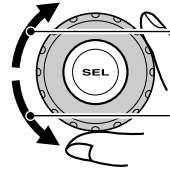

To increase the level or turn on the loudness



To decrease the level or turn off the loudness

Indication pattern changes as you adjust the bass or treble.

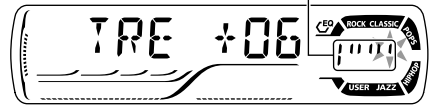

Ex. 1: When you adjust "TRE" (treble)



Ex. 2: When you turn on the loudness

3 Repeat steps 1 and 2 to adjust the other items.

To reset each sound mode to the factory settings, repeat the same procedure and reassign the preset values listed in the table on page 27.

OTHER MAIN FUNCTIONS



Changing the general settings (PSM)

You can change the items listed in the table below and on page 30 by using the PSM (Preferred Setting Mode) control.

Basic Procedure

- 1 Press and hold SEL (select) for more than 2 seconds so that one of the PSM items appears on the display. (See below and page 30.)



- 2 Select the PSM item you want to adjust.

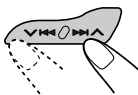

- 3 Adjust the PSM item selected.



- 4 Repeat steps 2 and 3 to adjust the other PSM items if necessary.

- 5 Finish the setting.



Preferred Setting Mode (PSM) items

- For detailed operations of each PSM items, refer to the pages listed in the table.

Indications		Selectable values/items		Factory-preset settings	See page
DEMO	Display demonstration	DEMO OFF	DEMO ON	DEMO ON	6
CLOCK H	Hour adjustment	0 — 23 (1 — 12)		0 (0:00)	7
CLOCK M	Minute adjustment	00 — 59		00 (0:00)	
24H/12H	24/12-hour time display	12H	24H	24H	7
AUTO ADJ	Automatic clock setting	OFF	ON	ON	16
AF-REG	Alternative frequency/ Regionalization reception	AF	↔ AF REG OFF*1 ↔	AF	11, 12

*1 Displayed only when the "DAB AF" is set to "OFF."

CONTINUED ON THE NEXT PAGE



Indications		Selectable values/items		Factory-preset settings	See page
PTY STBY	PTY standby	OFF → 29 programme types (see page 17) ↑		OFF	13
TA VOL	Traffic announcement volume	VOL 00 — VOL 30 or 50* ²		VOL 20	16
P-SEARCH	Programme search	OFF	ON	OFF	16
DAB AF * ³	Alternative frequency search	AF OFF	AF ON	AF ON	42
DAB VOL * ³	DAB volume adjustment	VOL -12 — VOL 12		VOL 00	42
LEVEL	Level display	OFF	ON	ON	31
DIMMER	Dimmer mode	AUTO ↔ OFF ↙ ON ↘		AUTO	31
TEL	Telephone muting	OFF ↔ MUTING 1 ↙ MUTING 2 ↘		OFF	31
SCROLL	Scroll mode	ONCE ↔ AUTO ↙ OFF ↘		ONCE	31
EXT IN * ⁴	External component	CHANGER	LINE IN	CHANGER	32
TAG DISP	Tag display	TAG OFF	TAG ON	TAG ON	32
AMP GAIN	Amplifier gain control	LOW PWR	HIGH PWR	HIGH PWR	32

*² Depending on the amplifier gain control setting. (See page 32 for details.)

*³ Displayed only when the DAB tuner is connected.

*⁴ Displayed only when one of the following sources is selected—FM, AM, and CD.



To select the level meter—LEVEL

You can activate or deactivate the level meter according to your preference.

When shipped from the factory, level meter is activated.

- ON: Shows the audio level indicator.
- OFF: Cancels the audio level indicator; sound mode indicator is shown.

To select the dimmer mode—DIMMER

When you turn on the car headlights, the display automatically dims (Auto Dimmer).

When shipped from the factory, Auto Dimmer mode is activated.

- AUTO: Activates Auto Dimmer.
- OFF: Cancels Auto Dimmer.
- ON: Always dims the display.

Note:

Auto Dimmer equipped for this unit may not work correctly on some vehicles, particularly on those having a control dial for dimming.

In this case, set the dimmer mode to "ON" or "OFF."

To select the telephone muting—TEL

This mode is used when a cellular phone system is connected. Depending on the phone system used, select either "MUTING 1" or "MUTING 2" whichever mutes the sounds from this unit. When shipped from the factory, this mode is deactivated.

- MUTING 1: Select if this setting can mute the sounds.
- MUTING 2: Select if this setting can mute the sounds.
- OFF: Cancels the telephone muting.

To select the scroll mode—SCROLL

You can select the scroll mode for the disc information (when the entire text cannot be shown at once).

When shipped from the factory, scroll mode is set to "ONCE."

- ONCE: Scrolls only once.
- AUTO: Repeats the scroll (5-second intervals in between).
- OFF: Cancels scroll mode.

Note:

Even if the scroll mode is set to "OFF," you can scroll the display by pressing DISP (display) for more than one second.



To select the external component to use —EXT IN

You can connect the external component to the CD changer jack on the rear using the Line Input Adapter KS-U57 (not supplied).

To use the external component as the playback source through this unit, you need to select which component—CD changer or external component—to use.

When shipped from the factory, CD changer is selected as the external component.

- **CHANGER:** To use the CD changer.
- **LINE IN:** To use the external component other than CD changer.

Note:

For connecting the Line Input Adapter KS-U57 and the external component, refer to the Installation/Connection Manual (separate volume).

To turn the tag display on or off —TAG DISP

An MP3 file can contain file information called “ID3 Tag” where its album name, performer, track title, etc. are recorded.

There are two versions—ID3v1 (ID3 Tag version 1) and ID3v2 (ID3 Tag version 2). If both ID3v1 and ID3v2 are recorded on a disc, ID3v2 information will be shown.

When shipped from the factory, “TAG ON” is selected.

- **TAG ON:** Turns on the ID3 tag display while playing MP3 files.
 - If an MP3 file does not have ID3 tags, folder name and file name appear.
- **TAG OFF:** Turns off the ID3 tag display while playing MP3 files. (Only the folder name and file name can be shown.)

To select the amplifier gain control —AMP GAIN

You can change the maximum volume level of this unit. When the maximum power of the speakers is less than 50 W, select “LOW PWR” to prevent them from being damaged.

When shipped from the factory, “HIGH PWR” is selected.

- **LOW PWR:** You can adjust the volume level from “VOL 00” to “VOL 30.”

Note:

If you change the setting from “HIGH PWR” to “LOW PWR” while listening at a volume level more than 30, the unit automatically changes the volume level to “VOL 30.”

- **HIGH PWR:** You can adjust the volume level from “VOL 00” to “VOL 50.”



Detaching the control panel

You can detach the control panel when leaving the car.
When detaching or attaching the control panel, be careful not to damage the connectors on the back of the control panel and on the panel holder.

Detaching the control panel

Before detaching the control panel, be sure to turn off the power.

1 Unlock the control panel.

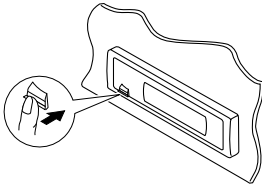

2 Pull the control panel out of the unit.

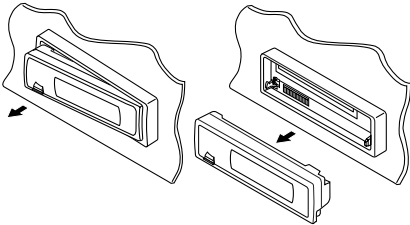

3 Put the detached control panel into the provided case.

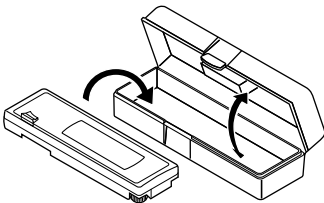

Attaching the control panel

1 Insert the right side of the control panel into the groove on the panel holder.

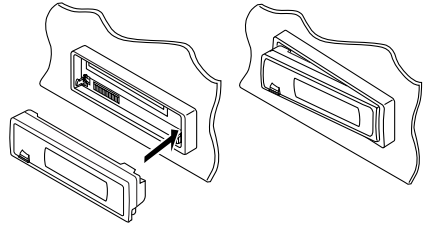

2 Press the left side of the control panel to fix it to the panel holder.

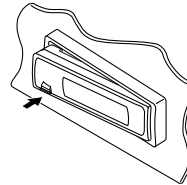

Note on cleaning the connectors:

If you frequently detach the control panel, the connectors will deteriorate.

To minimize this possibility, periodically wipe the connectors with a cotton swab or cloth moistened with alcohol, being careful not to damage the connectors.

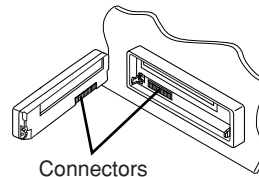



CD CHANGER OPERATIONS

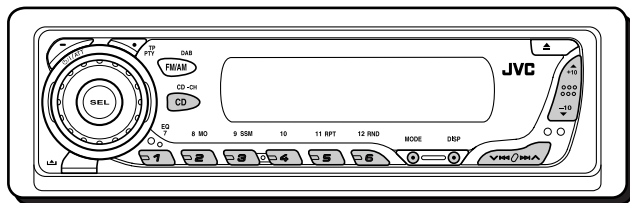

We recommend that you use the JVC MP3-compatible CD changer with your unit.

By using this CD changer, you can play back your original CD-Rs (Recordable) and CD-RWs (Rewritable) recorded either in audio CD format or in MP3 format.

- You can also connect other CH-X series CD changers (except CH-X99 and CH-X100). However, they are not compatible with MP3 discs, so you cannot play back MP3 discs.
- You cannot use the KD-MK series CD changers with this unit.

Before operating your CD changer:

- Refer also to the Instructions supplied for your CD changer.
- If no discs are in the magazine of the CD changer or the discs are inserted upside down, "NO DISC" will appear on the display. If this happens, remove the magazine and set the discs correctly.
- If no magazine is loaded in the CD changer, "NO MAG" appears on the display. If this happens, insert the magazine in the CD changer.
- If "RESET 1" – "RESET 8" appears on the display, something is wrong with the connection between this unit and the CD changer. If this happens, check the connection and make sure the cords are connected firmly. Then, press the reset button of the CD changer.

Playing discs

Select the CD changer (CD-CH).



* If you have changed "EXT IN" setting to "LINE IN" (see page 32), you cannot select the CD changer.

- **When the current disc is an MP3 disc:** Playback starts from the first folder of the current disc once file check is completed.

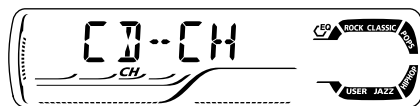

Selected disc number



(folder) indicator

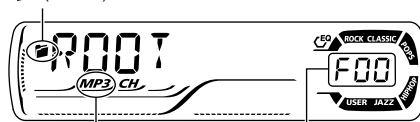

MP3 indicator

Selected folder number

Note:

Folder name appears on the display instead of "ROOT," if an MP3 disc contains a folder.

- **When the current disc is a CD:**
Playback starts from the first track of the current disc.

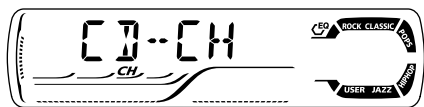

Selected disc number ↓

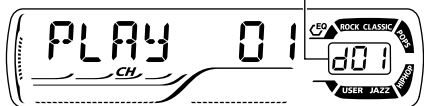

Elapsed playing time Current track number ↓

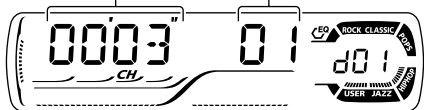

Notes:

- When you press CD CD-CH, the power automatically comes on. You do not have to press **⏻/I/ATT** to turn on the power.
- If you change the source, CD changer play also stops. Next time you select the CD changer as the source, CD changer play starts from where playback has been stopped previously.
- When you start playing back a CD Text or MP3 disc, disc information will automatically appear on the display. (See pages 21 and 24.)

To go to a particular disc directly

Press the number button corresponding to the disc number to start its playback (while the CD changer is playing).

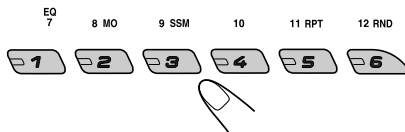

- To select a disc number from 1 – 6:
Press 1 (7) – 6 (12) briefly.
- To select a disc number from 7 – 12:
Press and hold 1 (7) – 6 (12) for more than one second.

To fast-forward or reverse the track/file



Press and hold **▶▶|▲**, during play, to fast-forward the track/file.

Press and hold **▼|◀◀**, during play, to reverse the track/file.

Note:

During this operation, you can only hear intermittent sounds. (The elapsed playing time also changes intermittently on the display.)

To skip to the next or previous tracks/files



Press **▶▶|▲** briefly during play, to skip ahead to the beginning of the next track/file. Each time you press the button consecutively, the beginning of the next tracks/files is located and played back.

Press **▼|◀◀** briefly during play, to skip back to the beginning of the current track/file.

Each time you press the button consecutively, the beginning of the previous tracks/files is located and played back.

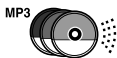

This operation is only possible when using JVC MP3-compatible CD changer (CH-X1500).

To go to a track/file quickly (+10 and -10 buttons)

- 1 Press MODE to enter the functions mode while playing a disc.

MODE



- 2 Press +10 or -10.

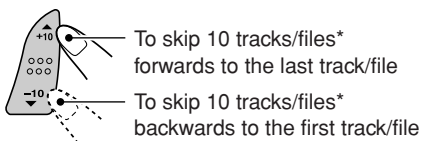

* First time you press +10 or -10 button, the track/file skips to the nearest higher or lower track/file with a track/file number of multiple ten (ex. 10th, 20th, 30th).

Then each time you press the button, you can skip 10 tracks/files (see "How to use the +10 and -10 buttons" below).

- After the last track/file, the first track/file will be selected, and vice versa.

Note:

If the current playing disc is an MP3 disc, files are skipped within the same folder.

How to use the +10 and -10 buttons

- Ex. 1: To select track/file number 32 while playing track/file number 6

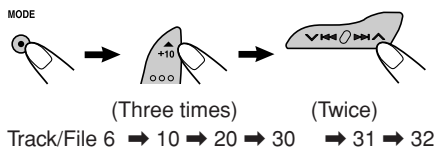

- Ex. 2: To select track/file number 8 while playing track/file number 36

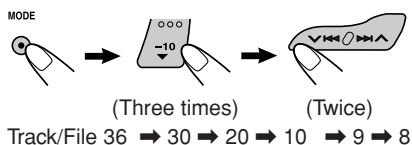

To skip to the next or previous folder (only for MP3 discs)

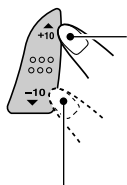

Press ▲ (up) while playing an MP3 disc, to go to the next folder.

Each time you press the button consecutively, the next folder is located, and the first file in the folder starts playback.

Press ▼ (down) while playing an MP3 disc, to go to the previous folder.

Each time you press the button consecutively, the previous folder is located, and the first file in the folder starts playback.

To show the disc information for CD Text and MP3 discs

This is possible only when connecting a JVC CD changer equipped with CD Text and/or MP3 disc information reading capability.

Select text display mode while playing a CD Text or an MP3 disc.

DISP



- For details, see page 21 about CD Text disc information and page 24 about MP3 disc information.

Selecting the playback modes

To play back tracks/files at random (Folder Random/Disc Random/Magazine Random Play)

- 1 Press MODE to enter the functions mode during play.
- 2 Press RND (random), while "MODE" is still flashing on the display. Each time you press the button, the random play mode changes as follows:

For MP3 discs:

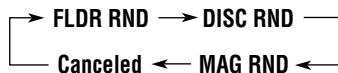

For CDs:

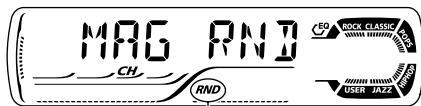

RND indicator

Ex.: When you select "MAG RND"

Note:

MP3 indicator also lights up if the current playing disc is an MP3 disc.

Mode	Active indicator	Plays at random
FLDR RND*	RND and indicators light up.	All files of the current folder, then files of the next folder and so on.
DISC RND	RND and indicators light up.	All tracks/files of the current (or specified) disc.
MAG RND	RND indicator lights up.	All tracks/files of the inserted discs.

* "FLDR RND" is only applicable for MP3 discs.

To play back tracks/files repeatedly (Track Repeat/Folder Repeat/Disc Repeat Play)

- 1 Press MODE to enter the functions mode during play.
- 2 Press RPT (repeat), while "MODE" is still flashing on the display. Each time you press the button, the repeat play mode changes as follows:

For MP3 discs:

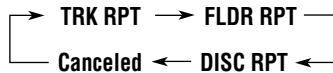

For CDs:

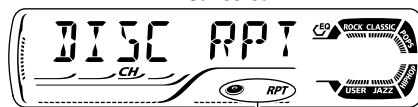

(disc) and RPT indicators

Ex.: When you select "DISC RPT"

Note:

MP3 indicator also lights up if the current playing disc is an MP3 disc.

Mode	Active indicator	Plays repeatedly
TRK RPT	RPT indicator lights up.	The current (or specified) track/file.
FLDR RPT*	and RPT indicators light up.	All files of the current (or specified) folder of the current disc.
DISC RPT	and RPT indicators light up.	All tracks/files of the current (or specified) disc.

* "FLDR RPT" is only applicable for MP3 discs.



EXTERNAL COMPONENT OPERATIONS

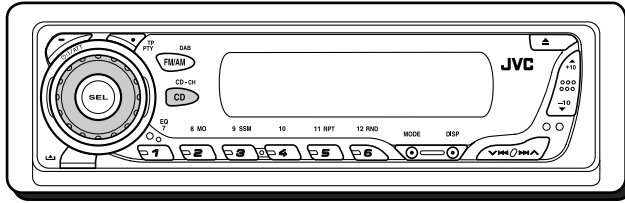

Playing an external component

You can connect the external component to the CD changer jack on the rear using the Line Input Adapter KS-U57 (not supplied).

Preparations:

- For connecting the Line Input Adapter KS-U57 and the external component, refer to the Installation/Connection Manual (separate volume).
- Before operating the external component using the following procedure, select the external input correctly. See “To select the external component to use—EXT IN” on page 32.

1 Select the external component (LINE IN).



- If “LINE IN”* does not appear on the display, see page 32 and select the external input (“LINE IN”).

* Displayed only when one of the following sources is selected—FM, AM, and CD.

Note on One-Touch Operation:

When you press CD CD-CH, the power automatically comes on. You do not have to press /ATT to turn on the power.

2 Turn on the connected component and start playing the source.

3 Adjust the volume.

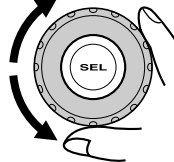

4 Adjust the sound as you want. (See pages 27 and 28.)

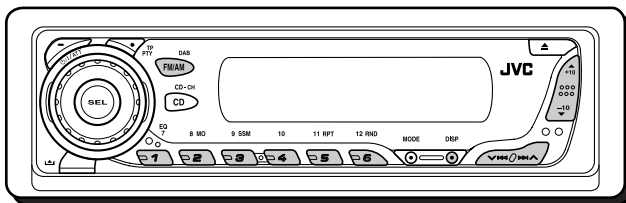

We recommend that you use DAB (Digital Audio Broadcasting) tuner KT-DB1500 or KT-DB1000 with your unit.

If you have another DAB tuner, consult your JVC IN-CAR ENTERTAINMENT dealer.

- Refer also to the Instructions supplied for your DAB tuner.

What is DAB system?

DAB is one of the digital radio broadcasting systems available today. It can deliver CD quality sound without any annoying interference and signal distortion.

Furthermore, it can carry text, pictures, and data.

In contrast to FM broadcast, where each programme is transmitted on its own frequency, DAB combines several programmes (called “services”) to form one “ensemble.”

In addition, each “service”—called “primary service”—can also be divided into its components (called “secondary service”).

With the DAB tuner connected with this unit, you can enjoy these DAB services.

Note:

When reception switches between DAB and FM, the listening volume level may increase or decrease inconveniently. This change in the volume level results from unequal audio injection levels at broadcaster site, but not from the malfunction of this unit.

To prevent this inconvenience, you can adjust the DAB volume level. (See “To adjust the DAB volume level” on page 42.)

Tuning in to an ensemble and one of the services

A typical ensemble has 6 or more programmes (services) broadcast at the same time. After tuning in to an ensemble, you can select a service you want to listen to.

Before you start...

Press FM/AM DAB briefly if CD, CD changer, or external component is the current source.

1 Select the DAB tuner.



Each time you press and hold the button, the DAB tuner and the FM/AM tuner are alternately selected.

DAB ↔ FM/AM

2 Select the DAB band (DAB1, DAB2, or DAB3).



Each time you press the button, the DAB band changes as follows:

→ DAB1 → DAB2 → DAB3

Note:

This receiver has three DAB bands (DAB1, DAB2, DAB3). You can use any of them to tune in to an ensemble.

3 Start searching for an ensemble.

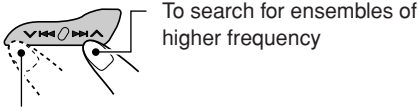

To search for ensembles of lower frequency

When an ensemble is received, searching stops.

To stop searching before an ensemble is received, press the same button you have pressed for searching.

4 Select a service (either primary or secondary) you want to listen to.

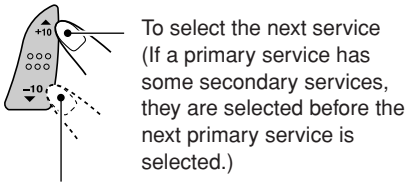

To select the previous service (either primary or secondary)

To change the display information while tuning in to an ensemble

Normally service name is shown on the display. If you want to check the ensemble name or its frequency, press DISP (display) repeatedly.



Each time you press the button, the following information appears for a while on the display.

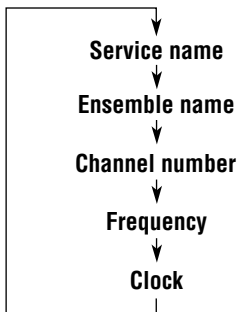

To tune in to a particular ensemble without searching

Before you start....

Press FM/AM DAB briefly if CD, CD changer, or external component is the current source.

- 1 Press and hold FM/AM DAB to select DAB tuner as the source.
- 2 Press FM/AM DAB repeatedly to select the DAB band (DAB1, DAB2, or DAB3).
- 3 Press and hold ►►| ▲ or ▼ |◄◄ for more than one second.
- 4 Press ►►| ▲ or ▼ |◄◄ repeatedly until the ensemble you want is reached.
 - If you hold down the button, the frequency keeps changing until you release the button.
- 5 Press ▲ (up) or ▼ (down) to select a service (either primary or secondary) you want to listen to.

To restore the FM/AM tuner

Press and hold FM/AM DAB again.

Storing DAB services in memory

You can preset up to 6 DAB services in each DAB band (DAB1, DAB2, and DAB3) manually.

Before you start....

Press FM/AM DAB briefly if CD, CD changer, or external component is the current source.

1 Select the DAB tuner.

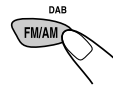

Each time you press and hold the button, the DAB tuner and the FM/AM tuner are alternately selected.

DAB ↔ FM/AM

2 Select the DAB band (DAB1, DAB2, or DAB3) you want.

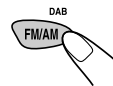

Each time you press the button, the DAB band changes as follows:



3 Tune in to an ensemble you want.

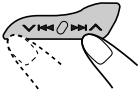

4 Select a service of the ensemble you want to listen to.

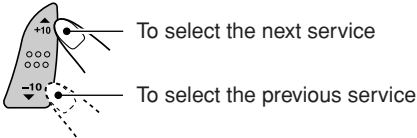

5 Press and hold the number button (in this example, 1) for more than 2 seconds to store the selected service into the preset number you want.

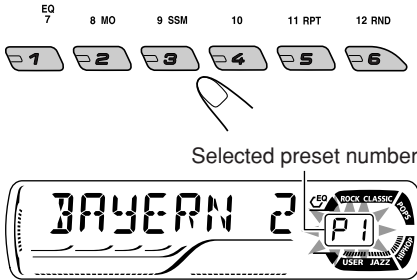

6 Repeat the above procedure to store other DAB services into other preset numbers.

Notes:

- You can only preset primary DAB services. If you store a secondary service, its primary service will be stored instead.
- A previously preset DAB service is erased when a new DAB service is stored in the same preset number.
- Preset DAB services are erased when the power supply to the memory circuit is interrupted (for example, during battery replacement). If this occurs, preset the DAB services again.

Tuning in to a preset DAB service

You can easily tune in to a preset DAB service. Remember that you must store services first. If you have not stored them yet, see “Storing DAB services in memory” on pages 40 and 41.

Before you start....

Press FM/AM DAB briefly if CD, CD changer, or external component is the current source.

1 Select the DAB tuner.

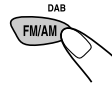

Each time you press and hold the button, the DAB tuner and the FM/AM tuner are alternately selected.

DAB ↔ FM/AM

2 Select the DAB band (DAB1, DAB2, or DAB3) you want.



Each time you press the button, the DAB band changes as follows:



3 Select the number (1 – 6) for the preset DAB service (primary) you want.

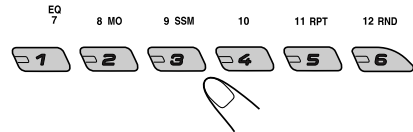

Note:

If the selected primary service has some secondary services, pressing the same number button repeatedly will tune in to the secondary services.

What you can do more with DAB

Tracing the same programme automatically (Alternative Reception)

You can keep listening to the same programme.

- **While receiving a DAB service:**
When driving in an area where a service cannot be received, this unit automatically tunes in to another ensemble or FM RDS station, broadcasting the same programme.
- **While receiving an FM RDS station:**
When driving in an area where a DAB service is broadcasting the same programme as the FM RDS station is broadcasting, this unit automatically tunes in to the DAB service.

To use Alternative Reception

When shipped from the factory, Alternative Reception is activated.

- See also “Changing the general settings (PSM)” on page 29.
- 1 Press and hold SEL (select) for more than 2 seconds so that one of the PSM items appears on the display.
 - 2 Press ►►| ▲ or ▼ |◄◄ to select “DAB AF” (alternative frequency).
 - 3 Turn the control dial to select the desired mode.
 - AF ON: Traces the programme among DAB services and FM RDS stations—Alternative Reception. The AF indicator lights up on the display (see page 11).
 - AF OFF: Alternative Reception is deactivated.
 - 4 Press SEL (select) to finish the setting.

Note:

When Alternative Reception (for DAB services) is activated, Network-Tracking Reception (for RDS stations: see page 11) is also activated automatically. On the other hand, Network-Tracking Reception cannot be deactivated without deactivating Alternative Reception.

To adjust the DAB volume level

You can adjust the volume level of DAB tuner and store it in memory. By adjusting the volume level properly to match it to the FM sound level, you will not need to adjust the volume level each time you change the source.

When shipped from the factory, DAB volume level is set at “00.”

- See also “Changing the general settings (PSM)” on page 29.
- 1 Press and hold SEL (select) for more than 2 seconds so that one of the PSM items appears on the display.
 - 2 Press ►►| ▲ or ▼ |◄◄ to select “DAB VOL” (volume).
 - 3 Turn the control dial to set to the desired volume.
You can set it from “VOL -12” to “VOL 12.”
 - 4 Press SEL (select) to finish the setting.

USING THE REMOTE CONTROLLER



This unit can be remotely controlled as instructed here (**with an optionally purchased remote controller**). We recommend that you use remote controller RM-RK50 or RM-RK60 with your unit. (Ex.: When you are using RM-RK60)

Before using the remote controller:

- Aim the remote controller directly at the remote sensor on the main unit. Make sure there is no obstacle in between.

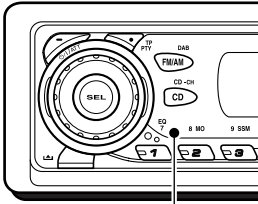

Remote sensor

- Do not expose the remote sensor to strong light (direct sunlight or artificial lighting).

Installing the battery

When the controllable range or effectiveness of the remote controller decreases, replace the battery.

1. Remove the battery holder.

- 1) Push out the battery holder in the direction indicated by the arrow using a ball point pen or a similar tool.
- 2) Remove the battery holder.

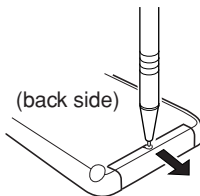

2. Place the battery.

Slide the battery into the holder with the + side facing upwards so that the battery is fixed in the holder.

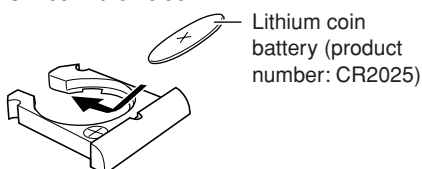

3. Return the battery holder.

Insert again the battery holder by pushing it until you hear a clicking sound.

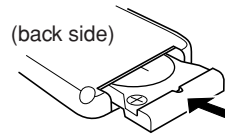

WARNING:

- Store the battery in a place where children cannot reach.
If a child accidentally swallows the battery, consult a doctor immediately.
- Do not recharge, short, disassemble, or heat the battery or dispose of it in a fire.
Doing any of these things may cause the battery to give off heat, crack, or start a fire.
- Do not leave the battery with other metallic materials.
Doing this may cause the battery to give off heat, crack, or start a fire.
- When throwing away or saving the battery, wrap it in tape and insulate; otherwise, the battery may start to give off heat, crack, or start a fire.
- Do not poke the battery with tweezers or similar tools.
Doing this may cause the battery to give off heat, crack, or start a fire.

CAUTION:

DO NOT leave the remote controller in a place (such as dashboards) exposed to direct sunlight for a long time. Otherwise, it may be damaged.

KD-G502 is equipped with the steering wheel remote control function.

If your car is equipped with the steering wheel remote controller, you can operate the unit using the controller.

- See the Installation/Connection Manual (separate volume) for connection to utilize this function.



Location of the buttons

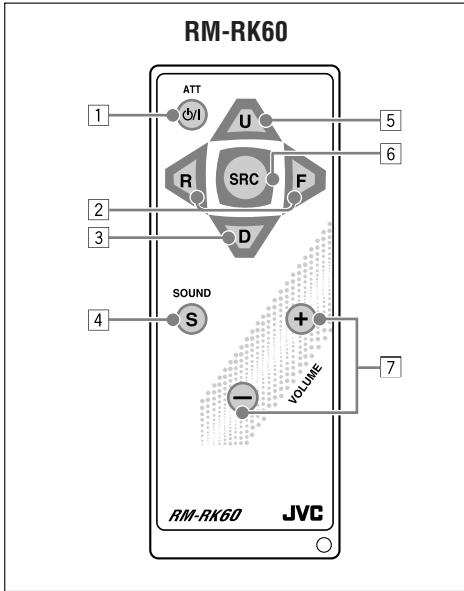

- 1 • Turns on the unit if pressed when the unit is turned off.
 - Turns off the unit if pressed and held until “SEE YOU” appears on the display.
 - Drops the volume level in a moment if pressed briefly.
Press again to resume the volume.
- 2 • Searches for stations while listening to the radio.
 - Selects services while listening to the DAB tuner if pressed briefly.
 - Searches for ensembles while listening to the DAB tuner if pressed for more than one second.
 - Fast-forwards or reverses the track/file if pressed and held while listening to a disc.
 - Skips to the beginning of the next track/file or goes back to the beginning of the current (or previous) tracks/files if pressed briefly while listening to a disc.
- 3 • Selects the preset stations (or services) while listening to the radio (or the DAB tuner).

Each time you press the button, the preset station (or service) number increases, and the selected station (or service) is tuned in.

 - Skips to the first file of the previous folder while listening to an MP3 disc.

Each time you press the button, you can move to the previous folder and start playing the first file.
 - While playing an MP3 disc on an MP3-compatible CD changer;
 - Skips to the previous disc if pressed briefly.
 - Skips to the previous folder if pressed and held.

Note: While playing a CD on a CD changer, this always skips to the previous disc.
- 4 • Selects the sound mode (C-EQ: custom equalizer).

Each time you press the button, the sound mode (C-EQ) changes.
- 5 • Selects the band while listening to the radio (or the DAB tuner).

Each time you press the button, the band changes.

 - Skips to the first file of the next folder while listening to an MP3 disc.

Each time you press the button, you can move to the next folder and start playing the first file.
 - While playing an MP3 disc on an MP3-compatible CD changer;
 - Skips to the next disc if pressed briefly.
 - Skips to the next folder if pressed and held.

Note: While playing a CD on a CD changer, this always skips to the next disc.
- 6 • Selects the source.

Each time you press the button, the source changes.
- 7 • Functions the same as the control dial on the main unit.

Note: These buttons do not function for the preferred setting mode adjustment.

TROUBLESHOOTING

What appears to be trouble is not always serious. Check the following points before calling a service center.

	Symptoms	Causes	Remedies
General	<ul style="list-style-type: none"> Sound cannot be heard from the speakers. 	The volume level is set to the minimum level.	Adjust it to the optimum level.
		Connections are incorrect.	Check the cords and connections.
	<ul style="list-style-type: none"> This unit does not work at all. 	The built-in microcomputer may have functioned incorrectly due to noise, etc.	Press the reset button on the panel holder after detaching the control panel. (The clock setting and preset stations stored in memory are erased.) (See page 2.)
FM/AM	<ul style="list-style-type: none"> SSM (Strong-station Sequential Memory) automatic preset does not work. 	Signals are too weak.	Store stations manually.
	<ul style="list-style-type: none"> Static noise while listening to the radio. 	The aerial is not connected firmly.	Connect the aerial firmly.
Disc Playback	<ul style="list-style-type: none"> Disc cannot be played back. 	Disc is inserted upside down.	Insert the disc correctly.
	<ul style="list-style-type: none"> CD-R/CD-RW cannot be played back. Tracks on the CD-R/CD-RW cannot be skipped. 	CD-R/CD-RW is not finalized.	<ul style="list-style-type: none"> Insert a finalized CD-R/CD-RW. Finalize the CD-R/CD-RW with the component which you used for recording.
		Disc cannot be ejected.	Disc is locked.
	<ul style="list-style-type: none"> Disc sound is sometimes interrupted. 	You are driving on rough roads.	Stop playback while driving on rough roads.
		Disc is scratched.	Change the disc.
		Connections are incorrect.	Check the cords and connections.
<ul style="list-style-type: none"> "NO DISC" appears on the display. 	No disc in the loading slot.	Insert a disc into the loading slot.	
	Disc is inserted incorrectly.	Insert the disc correctly.	



Symptoms	Causes	Remedies
<ul style="list-style-type: none"> • Disc cannot be played back. 	No MP3 files are recorded on the disc.	Change the disc.
	MP3 files do not have the extension code <.mp3> in their file names.	Add the extension code <.mp3> to their file names.
	MP3 files are not recorded in the format compliant with ISO 9660 Level 1, Level 2, Romeo, or Joliet.	Change the disc. (Record MP3 files using a compliant application.)
<ul style="list-style-type: none"> • Noise is generated. 	The file played back is not an MP3 file (although it has the extension code <.mp3>).	Skip to another file or change the disc. (Do not add the extension code <.mp3> to non-MP3 files.)
<ul style="list-style-type: none"> • A longer readout time is required ("CHECK" keeps flashing on the display). 	Readout time varies due to the complexity of the folder/file configuration.	Do not use too many hierarchies and folders. Also, do not record any other types of audio tracks together with MP3 files.
<ul style="list-style-type: none"> • Files cannot be played back as you have intended them to play. 	Playback order is determined when the files are recorded.	_____
<ul style="list-style-type: none"> • Elapsed playing time is not correct. 	This sometimes occurs during play. This is caused by how the files are recorded on the disc.	_____
<ul style="list-style-type: none"> •  indicator flashes on the display. 	The current folder does not contain any MP3 file.	Select another folder.
<ul style="list-style-type: none"> • "NO FILES" appears on the display. 	The current disc does not contain any MP3 file.	Insert a disc that contains MP3 files.
<ul style="list-style-type: none"> • Correct characters are not displayed (e.g. album name). 	This unit can only display alphabets (capital: A–Z), numbers, and a limited number of symbols.	_____



Symptoms	Causes	Remedies
<ul style="list-style-type: none"> • “NO DISC” appears on the display. 	No disc is in the magazine.	Insert discs into the magazine.
	Discs are inserted upside down.	Insert discs correctly.
<ul style="list-style-type: none"> • “NO MAG” appears on the display. 	No magazine is loaded in the CD changer.	Insert the magazine.
<ul style="list-style-type: none"> • “RESET 8” appears on the display. 	This unit is not connected to the CD changer correctly.	Connect this unit and the CD changer correctly and press the reset button of the CD changer.
<ul style="list-style-type: none"> • “RESET 1” – “RESET 7” appears on the display. 	_____	Press the reset button of the CD changer.
<ul style="list-style-type: none"> • The CD changer does not work at all. 	The built-in microcomputer may function incorrectly due to noise, etc.	Press the reset button on the panel holder after detaching the control panel. (The clock setting and preset stations stored in memory are erased.) (See page 2.)

CD Changer

About mistracking:

Mistracking may result from driving on extremely rough roads. This does not damage the unit and the disc, but will be annoying.

We recommend that you stop disc play while driving on such rough roads.



MAINTENANCE

Handling discs

This unit has been designed to reproduce CDs, CD-Rs (Recordable), CD-RWs (Rewritable), and CD Texts.

- **This unit is also compatible with MP3 discs.**

How to handle discs

When removing a disc from its case, press down the center holder of the case and lift the disc out, holding it by the edges.

Center holder



- Always hold the disc by the edges. Do not touch its recording surface.

When storing a disc into its case, gently insert the disc around the center holder (with the printed surface facing up).

- Make sure to store discs into the cases after use.

To keep discs clean

A dirty disc may not be played correctly. If a disc does become dirty, wipe it with a soft cloth in a straight line from center to edge.



To play new discs

New discs may have some rough spots around the inner and outer edges. If such a disc is used, this unit may reject the disc.



To remove these rough spots, rub the edges with a pencil or ball-point pen, etc.

Moisture condensation

Moisture may condense on the lens inside the CD player in the following cases:

- After starting the heater in the car.
- If it becomes very humid inside the car.

Should this occur, the CD player may malfunction. In this case, eject the disc and leave the unit turned on for a few hours until the moisture evaporates.

When playing a CD-R or CD-RW

Before playing back CD-Rs or CD-RWs, read their instructions or cautions carefully.

- Use only "finalized" CD-Rs or CD-RWs.
- Some CD-Rs or CD-RWs may not be played back on this unit because of their disc characteristics, and for the following reasons:
 - Discs are dirty or scratched.
 - Moisture condensation on the lens inside the unit.
 - The pickup lens inside the unit is dirty.
- CD-RWs may require a longer readout time since the reflectance of CD-RWs is lower than that of regular CDs.
- CD-Rs or CD-RWs are susceptible to high temperatures or high humidity, so do not leave them inside your car.
- Do not use following CD-Rs or CD-RWs:
 - Discs with stickers, labels, or protective seal stuck to the surface.
 - Discs on which labels can be directly printed by an ink jet printer.

Using these discs under high temperatures or high humidity may cause malfunctions or damage to discs. For example,

- Stickers or labels may shrink and warp a disc.
- Stickers or labels may be peeled off so discs cannot be ejected.
- Print on discs may get sticky.

Read instructions or cautions about labels and printable discs carefully.

CAUTIONS:

- Do not insert 8 cm discs (single CDs) into the loading slot. (Such discs cannot be ejected.)
- Do not insert any disc of unusual shape—like a heart or flower; otherwise, it will cause a malfunction.
- Do not expose discs to direct sunlight or any heat source or place them in a place subject to high temperature and humidity. Do not leave them in a car.
- Do not use any solvent (for example, conventional record cleaner, spray, thinner, benzene, etc.) to clean discs.

Warped disc



Sticker



Sticker residue

Disc



Stick-on label

SPECIFICATIONS

AUDIO AMPLIFIER SECTION

Maximum Power Output:

Front: 50 W per channel

Rear: 50 W per channel

Continuous Power Output (RMS):

Front: 19 W per channel into 4 Ω , 40 Hz to 20 000 Hz at no more than 0.8% total harmonic distortion.

Rear: 19 W per channel into 4 Ω , 40 Hz to 20 000 Hz at no more than 0.8% total harmonic distortion.

Load Impedance: 4 Ω (4 Ω to 8 Ω allowance)

Tone Control Range:

Bass: ± 10 dB at 100 Hz

Treble: ± 10 dB at 10 kHz

Frequency Response: 40 Hz to 20 000 Hz

Signal-to-Noise Ratio: 70 dB

Line-Out Level/Impedance:

2.0 V/20 k Ω load (full scale)

Output Impedance: 1 k Ω

TUNER SECTION

Frequency Range:

FM: 87.5 MHz to 108.0 MHz

AM: (MW) 522 kHz to 1 620 kHz
(LW) 144 kHz to 279 kHz

[FM Tuner]

Usable Sensitivity:

11.3 dBf (1.0 μ V/75 Ω)

50 dB Quieting Sensitivity:

16.3 dBf (1.8 μ V/75 Ω)

Alternate Channel Selectivity (400 kHz):

65 dB

Frequency Response: 40 Hz to 15 000 Hz

Stereo Separation: 30 dB

Capture Ratio: 1.5 dB

[MW Tuner]

Sensitivity: 20 μ V

Selectivity: 35 dB

[LW Tuner]

Sensitivity: 50 μ V

CD PLAYER SECTION

Type: Compact disc player

Signal Detection System: Non-contact optical pickup (semiconductor laser)

Number of channels: 2 channels (stereo)

Frequency Response: 5 Hz to 20 000 Hz

Dynamic Range: 96 dB

Signal-to-Noise Ratio: 98 dB

Wow and Flutter: Less than measurable limit

MP3 decoding format:

MPEG 1/2 Audio Layer 3

Max. Bit Rate: 320 Kbps

GENERAL

Power Requirement:

Operating Voltage:

DC 14.4 V (11 V to 16 V allowance)

Grounding System: Negative ground

Allowable Operating Temperature: 0°C to +40°C

Dimensions (W \times H \times D):

Installation Size (approx.):

182 mm \times 52 mm \times 150 mm

Panel Size (approx.):

188 mm \times 58 mm \times 12 mm

Mass (approx.):

1.4 kg (excluding accessories)

Design and specifications are subject to change without notice.



Having TROUBLE with operation?

Please reset your unit

Refer to page of How to reset your unit

JVC



EN

© 2004 Victor Company of Japan, Limited

0604KKSMĐTJEIN