

# TRICITY BENDIX

Better Products. Better Value.

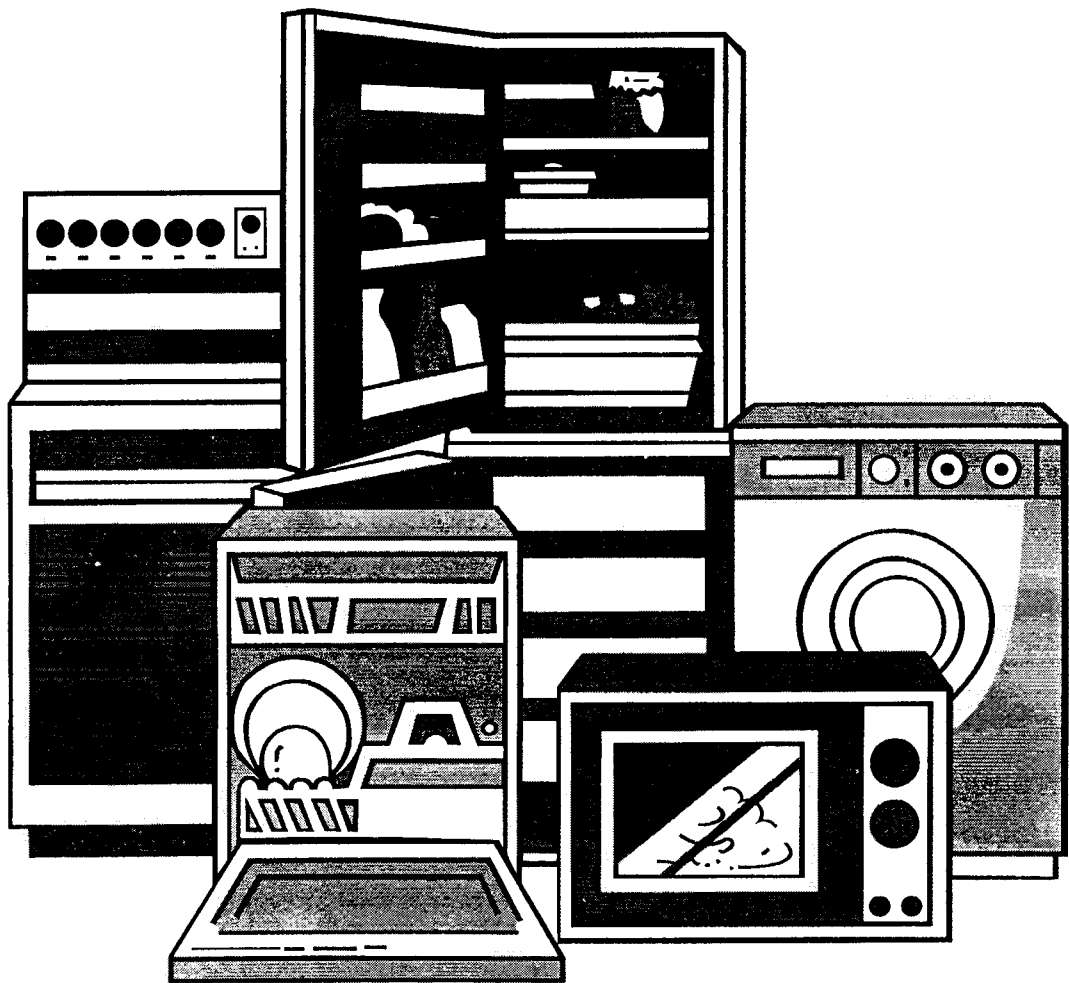

## Operating and Installation Instructions

MODEL NO.  
AW 410

# CONTENTS

<b>Warnings</b>	Page	3
<b>Installation</b>	Page	4
Unpacking	Page	4
Positioning	Page	5
Water inlet	Page	5
Plumbing connections	Page	5-6
Levelling	Page	6
Electrical connection	Page	7
<b>Getting to know your machine</b>	Page	8
Control panel	Page	8
Symbols	Page	8
Wash care symbols	Page	9
Programme charts.	Page	10-11
Using your machine	Page	12-13
Washing hints	Page	14
Detergents	Page	15
<b>Maintenance</b>	Page	16
Bodywork	Page	16
Detergent dispenser drawer	Page	16
Drain filter	Page	16
Water inlet filters	Page	17
<b>Something not working?</b>	Page	18
<b>Guarantee conditions</b>	Page	19
<b>Service Centres</b>	Page	20-23

# TECHNICAL SPECIFICATIONS

DIMENSIONS	Height	85 cm (23.6'')
	Width	60 cm (33.5'')
	Depth	57 cm (22.4'')
POWER SUPPLY VOLTAGE		220-240 V / 50 Hz
TOTAL POWER ABSORBED		2600 W (13 A)
WATER PRESSURE	Minimum (hot)	5 psi
	Minimum (cold)	7 psi
	Maximum	110 psi
MAXIMUM RECOMMENDED LOAD	Cotton, linen	4.5 kg (10 lb)
	Synthetics, delicate fabrics	2 kg (4.5 lb)
	Wool	1 kg (2.2 lb)
SPIN SPEED	Maximum	800 rpm

This appliance complies with E.E.C. directive No. 87/308 of 2.6.87 relative to radio interference suppression.

# IMPORTANT INFORMATION

---

**YOU MUST READ THE WHOLE OF THIS INSTRUCTION BOOK BEFORE YOU USE THE APPLIANCE. FOLLOW THE ADVICE CAREFULLY.**

**KEEP THE BOOK FOR FUTURE REFERENCE. IF YOU SELL OR GIVE AWAY THE APPLIANCE, MAKE SURE THAT THE BOOK IS PASSED TO THE NEW OWNER.**

## WARNINGS

- The following warnings are provided in the interest of overall safety. You must read them before the appliance is installed or used.

## INSTALLATION

- This appliance should not be installed in a bathroom or shower room.
- This appliance is heavy. Care should be taken when moving it.
- All packaging and transit bolts must be removed before the appliance is used. Serious damage may occur if this is not done.
- Any plumbing work required to install this appliance should be carried out by a qualified plumber or competent person.
- Any electrical work required to install this appliance should be carried out by a qualified electrician or competent person.
- Make sure that the appliance does not stand on its electrical supply cable.
- If the machine is situated on a carpeted floor, please adjust the feet to ensure that air can circulate freely.

## USAGE

- Always unplug the appliance and turn off the water after use.
- Do not overload the appliance.
- Only wash fabrics which are designed to be machine washed. If in doubt, consult the manufacturer of the fabric.
- Make sure that all pockets are empty. Hard, sharp objects such as coins, safety pins, nails, screws or stones can cause extensive damage.
- Do not machine wash fabrics which are saturated with petroleum products. If volatile cleaning fluids have been used, make sure that they are thoroughly removed from the fabric before it is placed in the appliance.
- Use only the recommended quantities of fabric conditioner.
- Leave the porthole door slightly ajar between washes to preserve the door seal.
- Before you open the door of the machine check that the water has drained. Do not open the door if you can still see water.

## SERVICE/REPAIR

- You should not attempt to repair the machine yourself. Repairs carried out by inexperienced or unqualified persons may cause injury and/or more serious faults to the machine.
- This product should be serviced by an authorised Tricity Bendix Service Centre only, and only genuine Tricity Bendix spare parts should be used.

## GENERAL SAFETY

- It is dangerous to modify the specifications of this appliance in any way.
- This appliance is designed to be used by adults. Children should not be allowed to touch the controls or play with the product.
- Pets and small children may climb into washing machines. Check your appliance each time before use.
- The glass door becomes very hot during washing cycle. Keep children away from the appliance while it is in use.

# INSTALLATION

## Unpacking

All transit bolts and packing **must** be removed before using the machine.

You are advised to keep all packing for re-use in case you move house and the machine has to be transported again.

Proceed as follows:

Using a spanner remove the screw on the right at the rear of the machine.

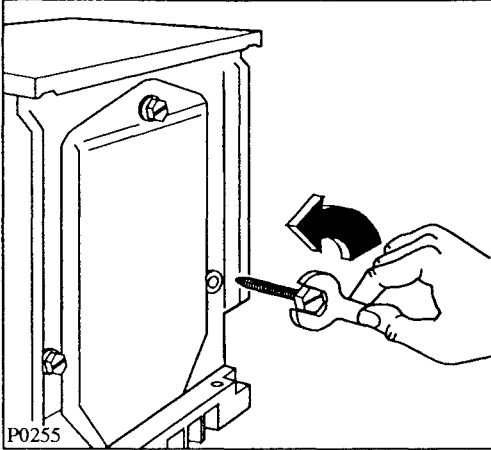

Carefully lay the machine on its back making sure that the hoses are not squashed.

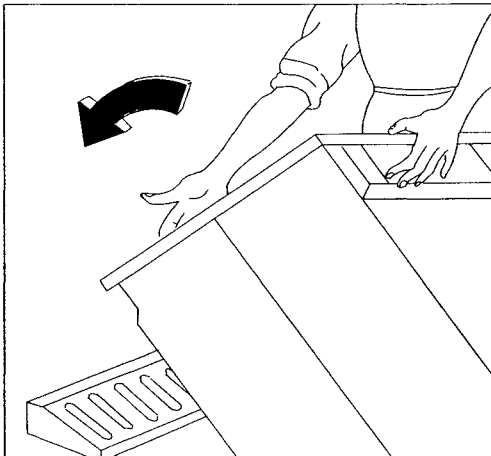

Remove the polystyrene panel from underneath the machine.

There is no need to keep this panel.

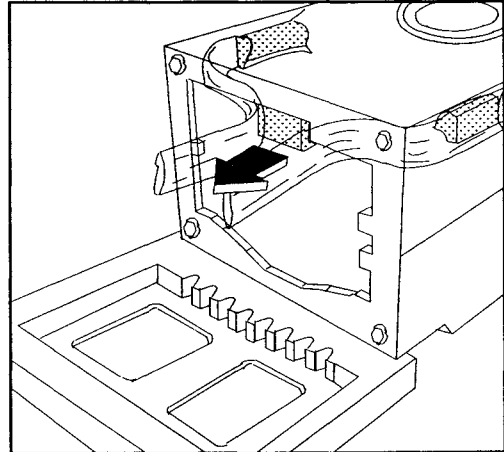

Carefully remove the polythene bag (on the right) by pulling it towards the centre of the machine.

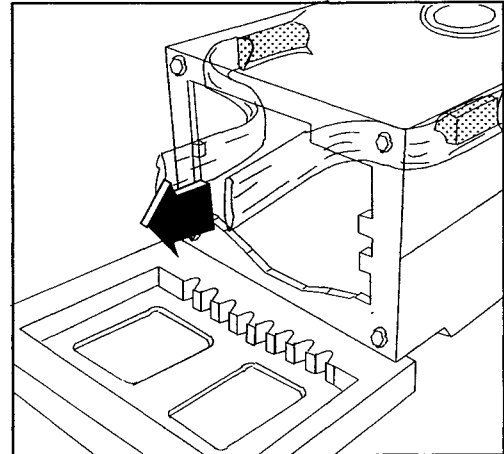

The left polythene bag can now also be removed from the machine.

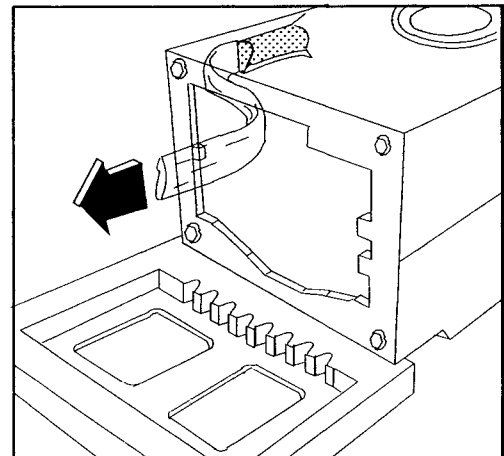

Set the machine upright and remove the remaining two screws on the back.

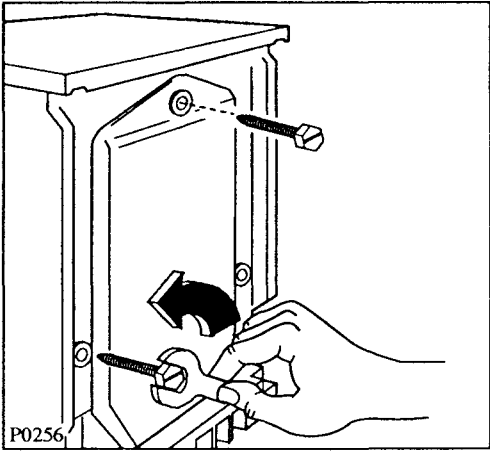

Remove the three plastic pins from the holes where the screws were previously fitted.

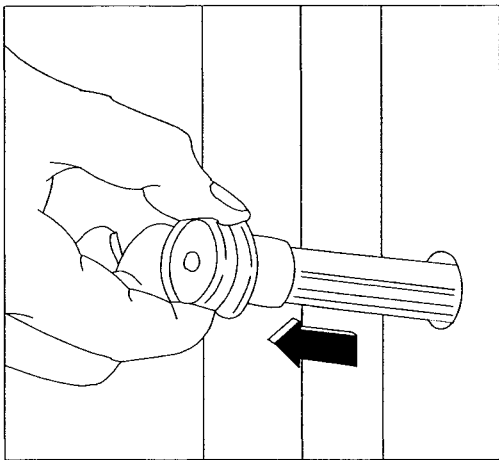

Plug the holes with the plugs which you can find on the back of the machine.

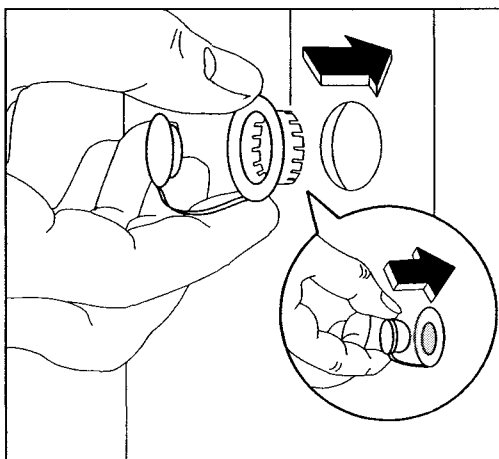

## Positioning

Position the machine on a firm level surface. Reinforce wooden floors with a solid wood panel (5 cm thick) or at least two boards. The supporting panel must protrude a few centimetres beyond the edge of the machine.

The machine must not touch the wall or other furniture.

It is assumed that the tap, drainage point and socket are within easy reach of the machine hoses and power supply cable. If not, you are advised to call your fitter in order to move the tap and/or drainage point and/or socket.

## Water inlet

The inlets on the back of the appliance are colour coded: blue for cold, red for hot. If only a cold water supply is available, connect the two hoses to a cold water outlet by means of a «Y» connection piece. Fit the rubber seal and connect the water inlet hoses to a tap with a 3/4" gas thread spout.

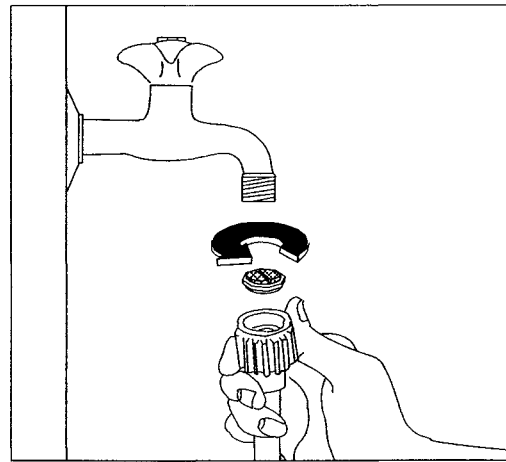

Although the machine is provided with its own aerator, your local water board may require the machine to be connected to a ventilated tap. If you know that the mains water supply pressure is often very high, fit a 3/4" 23x4x4 mm reducer at the joint between the water inlet hoses and the washing machine. The inlet hoses must not be extended. If they are too short and you do not wish to move the tap, replace them completely with longer high pressure hoses specifically designed to solve problems of this type.

The other end of the inlet hoses connected to the machine can be turned in any direction. Simply loosen the fitting, rotate the hoses and retighten.

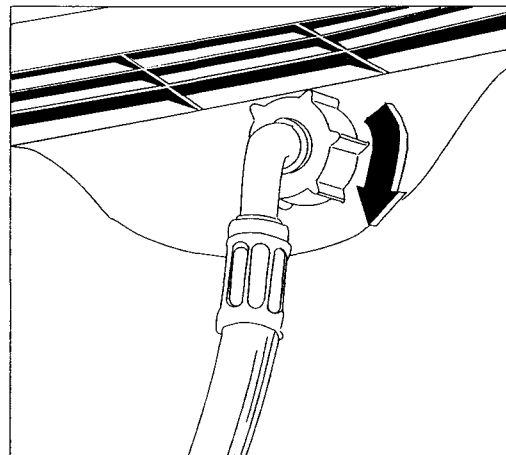

## Water drainage

The end of the drain hose can be positioned in three ways:

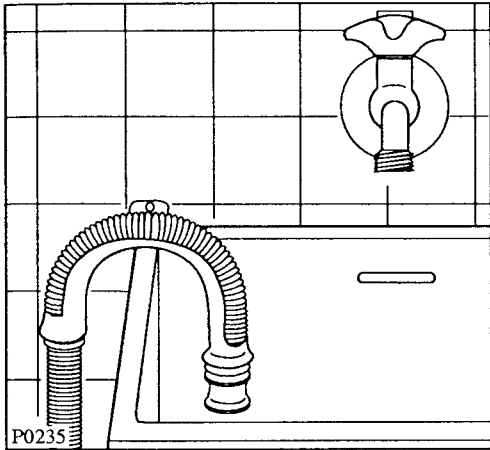

Over the edge of a basin: in this case you must ensure that the hose cannot move when the water is drained. Secure it to the wall with a hook, for example, or to the tap by means of a piece of string.

In a basin drainpipe branch: the branch must be above the basin siphon so that the end of the hose is at least 60 cm from ground level.

Directly in a drainpipe: you are advised to use a vertical 65 cm high pipe; in any case it should never be shorter than 60 cm or longer than 90 cm.

The end part of the drain hose must always be ventilated, i.e. the internal diameter of the pipe must be wider than the external diameter of the drain hose.

The drain hose can be extended up to a maximum length of 180 cm. Use an extension with an internal diameter at least equal to the diameter of the original hose and a suitable fitting. The hose extension will run along the floor and only the part near the drainage point will be raised.

## Levelling

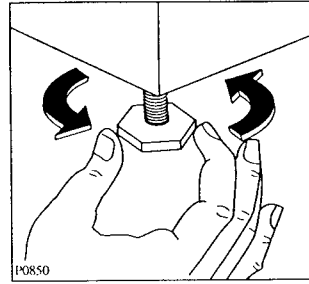

Level the washing machine by raising or lowering the feet.

The feet may be tight to adjust as they incorporate a self locking nut, but the machine **MUST** be level.

Any adjustment can be made by hand or with the spanner. Accurate

levelling prevents vibration, noise and displacement of the machine during operation.

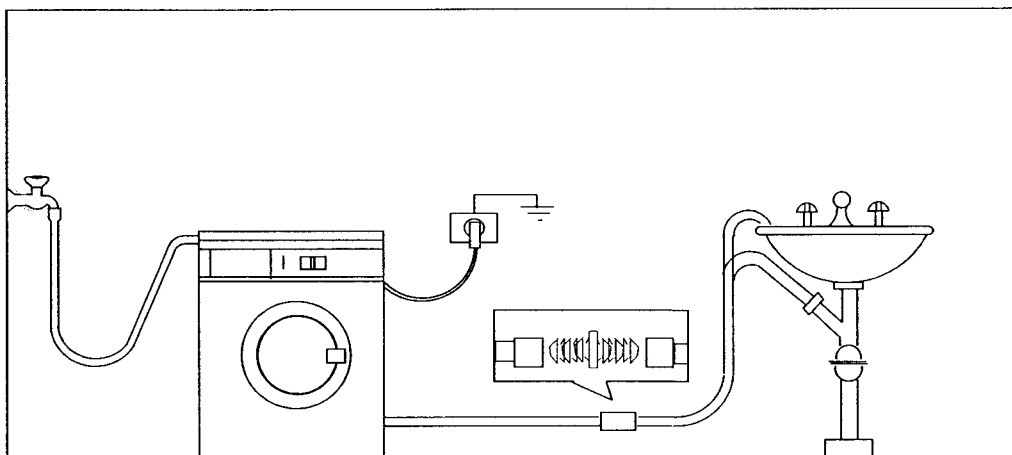

## Electrical connection

### WARNING

**THIS APPLIANCE MUST BE EARTHED.**

**The manufacturer declines any liability should this safety measure not be observed.**

1. If the plug fitted to the appliance is not suitable for your socket outlet, it must be cut off, and the appropriate plug fitted.

You should dispose of the cut-off plug, in order to prevent the hazard of electric shocks if it should be plugged into a 13 Amp socket in another part of your home.

### 2. IMPORTANT

The wires in this mains lead are coloured in accordance with the following code:

GREEN & YELLOW - EARTH  
BLUE - NEUTRAL  
BROWN - LIVE

If you fit your own plug the colours of the wires in the mains lead may not correspond with the markings identifying the terminals in your plug. Fit the plug as follows:

Connect the green and yellow (earth) wire to the terminal in the plug which is marked with the letter «E», or the earth symbol  $\perp$ , or coloured green or green and yellow.

Connect the blue (neutral) wire to the terminal in the plug which is marked with the letter «N», or coloured black.

Connect the brown (live) wire to the terminal in the plug which is marked with the letter «L», or coloured red.

3.1 There is a fuse incorporated into the moulded plug. When necessary this should be replaced by a 13 Amp BS 1362 fuse. Only ASTA approved fuses should be used.

3.2 The fuse cover/carrier must be replaced if the fuse is changed. The correct fuse cover/carrier is the one shown by the coloured insert at the base of the plug.

3.3 The plug must not be used if the fuse cover/carrier is lost. A replacement cover/carrier must be obtained from an Tricity Bendix Service Centre. There is a list of these at the end of this instruction book.



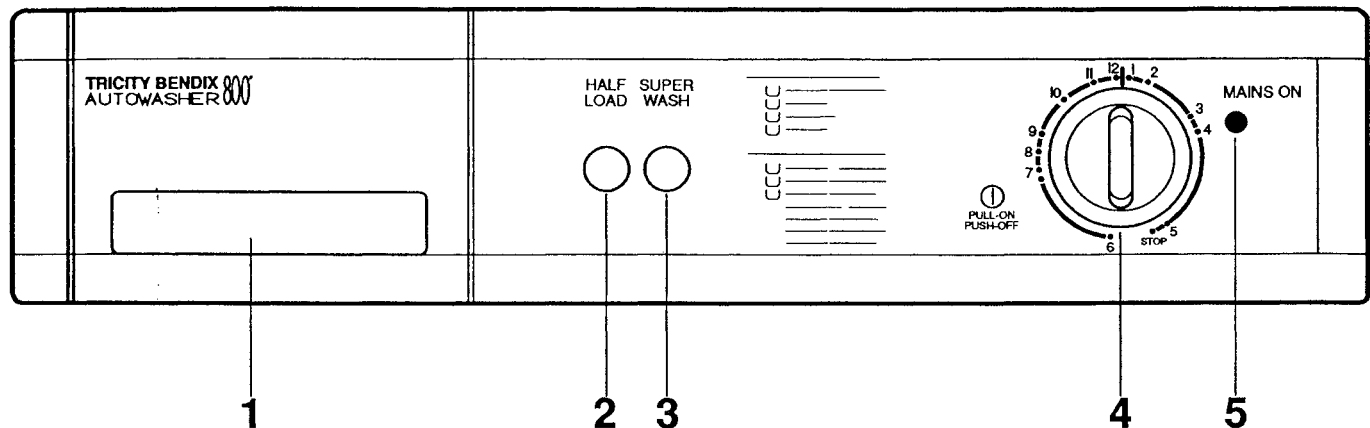

# GETTING TO KNOW YOUR MACHINE

## Control panel



- 1 Detergent dispenser drawer
- 2 HALF LOAD button
- 3 SUPER WASH button
- 4 Programme selector knob
- 5 MAINS ON light

## Symbols













-  Pre-wash: left compartment in the detergent dispenser drawer.
  -  Main wash: central compartment of the detergent dispenser drawer.
  -  Fabric softener - right compartment of the detergent dispenser drawer.
  -  IWS-programme for washing wool, for garments in pure new wool with machine-washable label.
- HALF LOAD** Select this button to reduce water consumption on the rinse cycle when washing a smaller load of cottons or linens. (Maximum load size = 2.25 kg).
- SUPER WASH** Press this button when the load is very heavily soiled. This will modify the water intake from hot, or hot & cold, to-cold only so that the wash water is gradually heated to the correct temperature. This creates the ideal conditions for biological detergents, improving wash results on stains such as egg, blood & grass.



-  Use this dial to select the required washing programme. Press the dial in and turn it **clockwise**.  
To start a programme, pull the dial outwards.  
To switch the machine off, press the dial in.
- MAINS ON** The mains on light comes on when the machine is working.













# WASH CODE SYMBOLS







These symbols appear on fabric labels, in order to help you choose the best way to treat your laundry.

<b>Strong wash</b>   <b>Delicate wash</b>	 Max. wash temperature 95°C	 Max. wash temperature 60°C	 Max. wash temperature 40°C	 Max. wash temperature 30°C	 Hand wash	 Do not wash at all
	 <b>95</b>	 <b>60</b>	 <b>40</b>	 <b>30</b>		

 <b>Bleaching</b>	 Bleach in cold water	 Do not bleach









 <b>Ironing</b>	 Hot iron max 200°C	 Warm iron max 150°C	 Lukewarm iron max 110°C	 Do not iron

 <b>Dry cleaning</b>	 Dry cleaning in all solvents	 Dry cleaning in perchloroethylene, petrol, pure alcohol, R 111 & R 113	 Dry cleaning in petrol, pure alcohol and R 113	 Do not dry clean

 <b>Drying</b>	 Flat	 On the line	 On clothes hanger	 high temperature	 Do not tumble dry
				 low temperature	

# PROGRAMMES FOR COTTON AND LINEN

Recommended load: max. 4.5 kg (10 lb)

PROGRAMMES	DEGREE OF SOIL	COMPARTMENTS TO USE (  if required)	PROGRAMME DIAL POSITION	DESCRIPTION
 PREWASH & BOILWASH	Heavy		<b>1</b>	Prewash at 40°C Wash at 95°C 5 rinses Spin.
 BOILWASH	Normal		<b>2</b>	Wash at 95°C 5 rinses Spin.
 HOT WASH	Normal		<b>3</b>	Wash at 60°C 5 rinses Spin.
 WARM WASH	Normal		<b>4</b>	Wash at 40°C 5 rinses Spin.
SPIN 800			<b>5</b>	Spin at 800 rpm

**Water filling**

40°/50°C programmes - cold water filling











60°C programmes - hot and cold filling

95°C programmes - hot water filling only

} unless SUPER WASH button is pressed.

# PROGRAMMES FOR SYNTHETICS, MIXED FABRICS, SILK AND WOOL

Recommended load: max. 2 kg (4.5 lb); wool max. 1 kg (2.2 lb)

PROGRAMMES	DEGREE OF SOIL	COMPARTMENTS TO USE (  if required)	PROGRAMME DIAL POSITION	DESCRIPTION
 NORMAL WASH	Normal		<b>6</b>	Wash at 50°C 3 rinses Stop with water left in drum (*)
 DELICATE WASH	Normal		<b>7</b>	Wash at 40°C 3 rinses Stop with water left in drum (*)
 WOOL WASH 	Normal		<b>8</b>	Wash at 40°C 3 rinses Stop with water left in drum (*)
<b>30</b> QUICK & COOL	Light		<b>9</b>	Wash at 30°C 3 rinses Stop with water left in drum (*)
RINSES			<b>10</b>	3 rinses, with fabric conditioner, if required. Stop with water left in drum (*)
CONDITIONER RINSE			<b>11</b>	1 rinse, with fabric conditioner, if required. Stop with water left in drum (*)
DRAIN			<b>12</b>	Draining of water

(\*) To finish the programme select position 5 (spin at 800 rpm) or position 12 (draining of water), according to the type of fabric.

# USING YOUR MACHINE

## 1. Place the laundry in the drum.

Open the loading door by pulling the catch outwards. Place the garments to be washed inside the drum one by one laying them as flat as possible. Close the door ensuring that the catch clicks into place.



## 2. Measure out the detergent into the dispenser drawer.

Pull out the detergent dispenser drawer from the control panel.

Pour the detergent into the main wash compartment. Follow the detergent manufacturer's guidelines for the amount required. Tricity Bendix recommends Ariel and Fairy Non-Biological detergents.

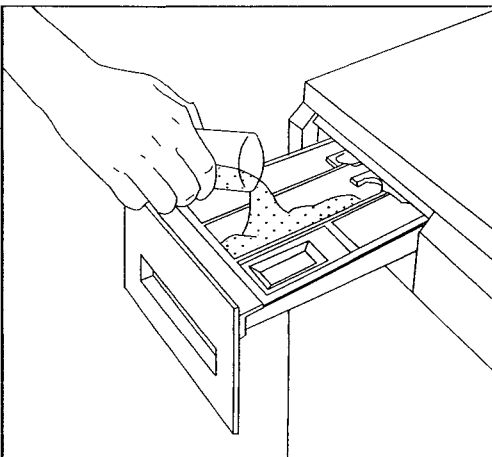

If you wish to carry out a prewash, pour the amount of detergent required into the «prewash» compartment.

## 3. Add the fabric softener if required.

Pour the softener, if required, into the compartment marked .

Do not exceed the MAX level.

Tricity Bendix recommends «Lenor» fabric softener.

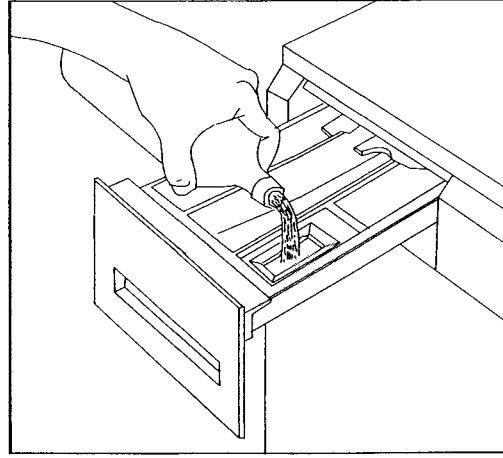

## 4. Press the button(s) required.

Press HALF LOAD or SUPER WASH, if required, depending on the programme selected.

## 5. Select the required programme.

Press the dial in and turn it **clockwise** until the marker on the dial **coincides exactly** with the programme position.

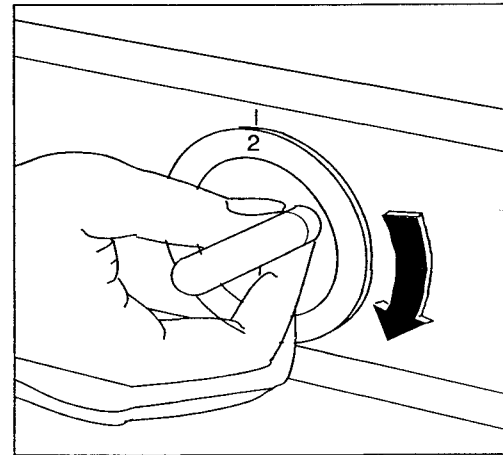

## 6. Start the machine.

Plug into the mains.

Turn on the water taps.

Check that the drain hose is correctly positioned.

Pull the programme dial outwards.

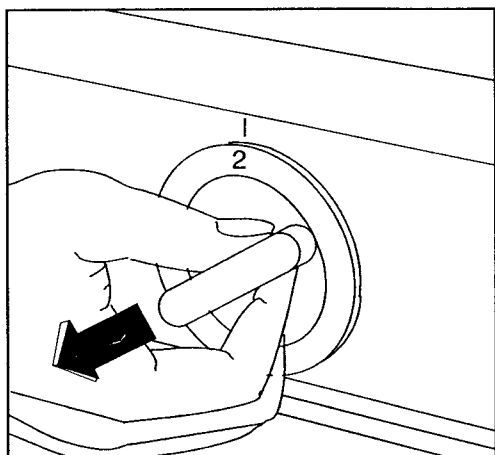

The «mains on» light comes on and the programme begins.

## 7. When the machine stops:

a) If you select programme 1, 2, 3, 4 or 5 (cotton/linen), the machine stops after spinning. The «mains on» light goes out.

Wait approximately 2 minutes before opening the door until the safety time delay has released the electric locking mechanism.

Press the programme selection dial in. Turn the water taps off and unplug the machine from the mains.

Open the door and remove the laundry.

Ensure that the drum is completely empty by rotating it with one hand.

Leave the door ajar for a while to eliminate any steam.

b) If you select programme 6, 7, 8, 9, 10 or 11 (synthetic/mixed fabric/silk/wool) the machine stops with water in the drum, to prevent the fabric from creasing. To finish the programme, select position 5 (spin at 800 rpm) or position 12 (draining of water), according to the type of fabric.

When the «mains on» light goes out, wait approximately 2 minutes before opening the door until the safety time delay has released the electric locking mechanism.

Then follow the guidelines given in 7 (a) above.

# WASHING HINTS FOR CORRECT TREATMENT OF YOUR LAUNDRY

You are advised not to leave your laundry too long, especially when damp. Damp laundry produces mould and unpleasant smells. Mould stains cannot be removed.

## Sort your laundry.

On page 16 of this booklet there is a chart which explains the symbols used on clothes labels. Study it carefully.

The following points are particularly important:

- a **line** under the bowl means that the garment cannot be washed using programmes for resistant fabrics such as cotton and linen;
- do not mix coloured garments with whites;
- antcrease materials like polyester/cotton should be treated as synthetics;
- non-resistant fabrics like acrylic and most curtain materials should be treated as delicate fabrics;
- the wool programme is designed specifically for pure new wool. Other types of wool and wool mixtures may shrink or felt if machine-washed.

Woollen garments should be spun briefly immediately after washing.

## Pre-wash

Pre-wash is not normally necessary. Your new washing machine combined with modern detergents will give perfect washing results without pre-wash, thus saving energy, time, water and detergent.

However, when the laundry is particularly dirty (for example if you have to wash mechanics' overalls or butchers' aprons), you are advised to use pre-wash with a biological detergent.

## Temperatures

When you see 40-60 for example on the programme chart, it means that you can select 40 or 60 as you wish or a temperature between these two.

We suggest that white cotton and linen, if it is not excessively soiled, can be washed at 60° instead of 95°. There should be no reduction in performance, but there will be an energy saving of approximately 30%.

The same applies to a lesser extent to fast coloured garments.

They usually require a temperature of 60° but if they are not excessively dirty, you will have satisfactory results at 40°.

Garments with non-fast colours should not be washed at temperatures above 40°C. If fast and non-fast colours are washed together, they should be treated as non-fast colours and therefore the temperature should not exceed 40°.

Resistant white and coloured synthetics can normally be washed at 50° but also in this case 40° is sufficient if the laundry is not excessively dirty.

Delicate synthetics, synthetics with non-fast colours and woollen garments must never be washed above 40°. If only one of the labels specifies 30°, this temperature must be selected for the whole wash. In most cases these garments can withstand 40° but Tricity Bendix cannot be held responsible for any damage caused by washing at temperatures higher than those specified.

In the programmes for delicate fabrics and wool there is a safety device in case a temperature higher than 40° is selected by mistake.

## How much laundry can be washed in one load?

Strictly speaking you should always weigh your laundry.

The drum will take a maximum of 4.5 kg of cotton and linen. For synthetics and delicate fabrics, the maximum load is 2 kg and for wool, 1 kg.

As weighing can be complicated, we suggest you estimate the weight according to how full the drum is:

**cotton and linen:** drum full but not too tightly packed

**resistant synthetics:** no more than  $\frac{2}{3}$  of the drum

**delicate fabrics and wool:** no more than  $\frac{1}{2}$  of the drum.

## Before placing the laundry in the machine:

mend all tears, holes and ladders;

secure loose buttons and close poppers and zips; do not wash frayed garments - mend hems before washing;

remove all small objects from pockets. Nails, pins, clips and similar objects can seriously damage your washing machine and laundry;

remove curtain hooks;

wash coloured garments and in particular those with non-fast colours separately when washing for the first time. They are likely to lose colour the first time they are washed.

treat obstinate stains such as grass, rust, tar, paint, ink etc. with a stain remover before washing.

To remove paint stains, for example, use a volatile substance such as turpentine: in this case, you should wait for it to dry completely before washing. Tricity Bendix is not responsible for any damage deriving from the use of volatile, inflammable or toxic substances.

## Detergents

Under no circumstances use detergents such as soap or hand-wash detergents which are not suitable for use in a washing machine.

They can badly damage your washing machine and laundry.

A liquid detergent can be used in the middle compartment of the dispenser drawer as long as you start the machine up straight away without pre-wash. You are advised to use powder detergents for temperatures over 40°C.

For pre-wash you are advised to use a specific biological detergent in powder form. Use an ordinary powder detergent for normal washing.

Special detergents are available for delicate fabrics and wool.

Here again, only detergents designed for use in washing machines must be used.

It may be advisable to use a liquid fabric softener when you are going to dry synthetic garments in the tumble dryer for example.

This prevents the fabrics becoming charged with static electricity.

## How much detergent?

Your washing machine is provided with a water circulation system, which means that it uses detergent sparingly.

Initially you are advised to use the quantities specified by the detergent manufacturer. Subsequently it is worth experimenting to see if your laundry comes out clean with smaller quantities. You should also take into account the hardness of the water in your area; if you do not know how hard it is, ask your local Water Authority.

If the drum is only half-full, you can obviously use less detergent: try with  $\frac{1}{4}$  less.

The lime present in the water will in the long run cause fabrics to go grey and felt, especially at high temperatures.

Detergents contain substances which absorb the lime and therefore you should increase the doses if your water is hard. You can, however, use less detergent and compensate for the difference by using a specific water softening product.

# MAINTENANCE

## Bodywork

The outside of the machine can be cleaned with warm water and a neutral non-abrasive household detergent. Wipe with clean water and dry after cleaning.

**Important:** do not use methylated spirit, diluents or similar products.

## Detergent dispenser drawer

After a while detergents and fabric softeners leave a deposit in the drawer.

It should be cleaned from time to time with a jet of running water.

If necessary it can be removed completely from the machine by pressing the catch down at the top on the left.

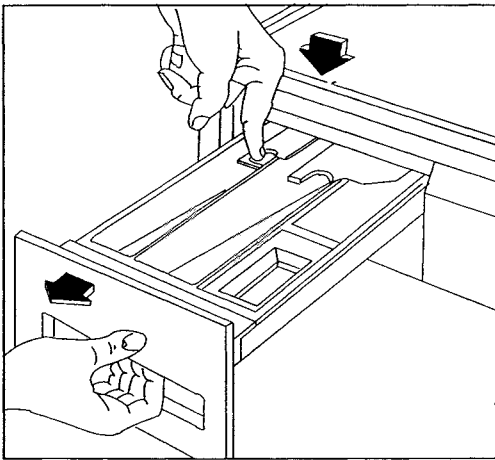

To facilitate cleaning, the upper part of the fabric softener compartment can be removed.

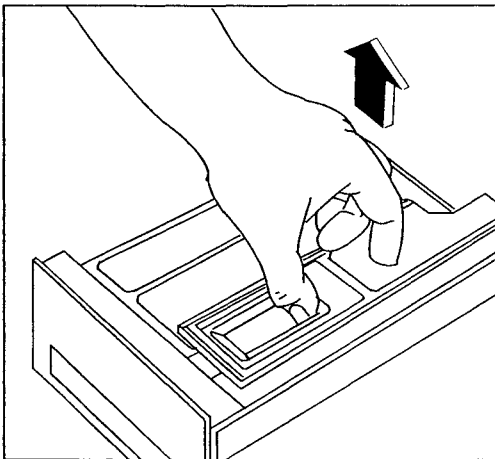

## The drawer recess

Detergent can also accumulate inside the recess which should be cleaned occasionally with an old toothbrush.

Once you have finished cleaning, replace the drawer and run a rinse cycle without laundry.

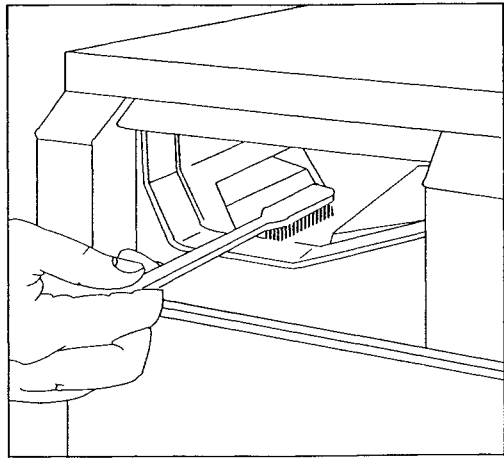

## The drain filter

The drain filter collects threads and small objects left in the laundry. **Check regularly that the filter is clean to ensure smooth running of your machine.**

Open the filter door by pressing on the bottom of it.

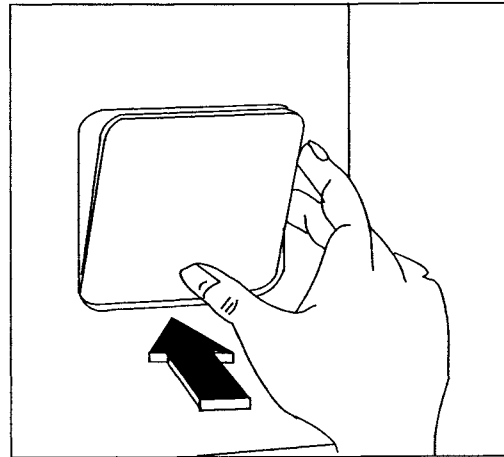

Place a bowl underneath and unscrew the filter by turning it to the left.

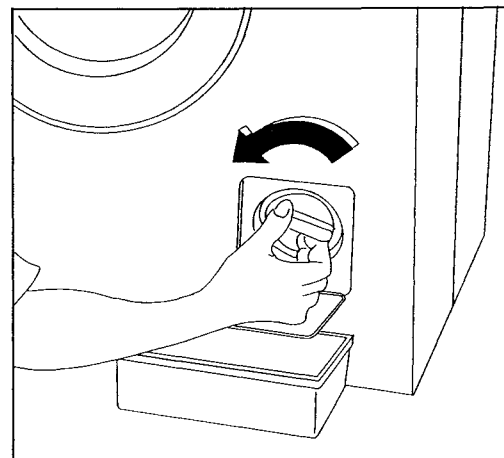



Remove the filter.

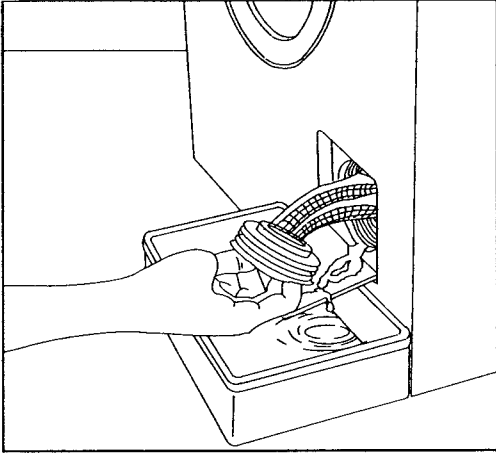

Clean it under a fast-running tap.

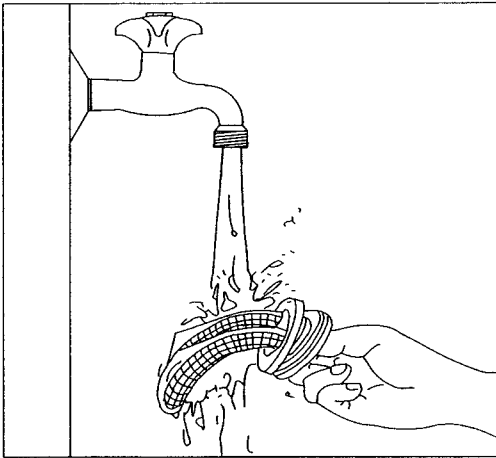

### Warning

When the appliance is in use there may be hot water in the filter. Never remove the filter during a wash cycle. Always wait until the appliance has finished the cycle, and is empty. When replacing the filter, ensure it is securely retightened so as to stop leaks, and to prevent young children being able to remove it.

### The water inlet filters

If your water is very hard or contains traces of lime deposit, the water inlet filters may become clogged. It is therefore a good idea to clean them from time to time.

Turn off the water taps.

Unscrew the water inlet hoses.

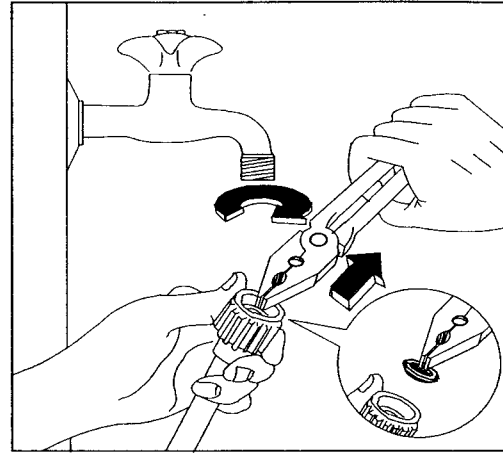

Remove and clean the filters using a hard bristle brush.

Replace the filters and tighten up the inlet hoses.

## SOMETHING NOT WORKING?

### If the machine does not start:

- Check that the door is firmly shut;
- Check that the mains fuse is intact;

### If the machine does not fill even though the pilot light is on:

- Is the tap on?
- Is water coming out of the tap? Check.
- Are the inlet hoses squashed or bent?
- Are the filters of the inlet hoses clogged?

### If the machine empties as it fills:

- The end of the drain hose is too low.

### If the machine does not drain and/or does not spin:

- Is the drain hose squashed or bent?
- Is the drain filter clogged?

### If there is water on the floor:

- Have you used too much detergent or unsuitable detergent? The formation of foam can cause water leaks.
- Is one of the joints or the tap leaking? It is not always easy to see as the leak often runs along the pipe.

### If the machine vibrates or is too noisy:

- Have all the transit bolts and packing been removed?
- Is the machine touching something?
- Are all the feet resting firmly on the ground? Have the lock nuts been secured?

If you are unable to identify or solve the problem, consult our servicing department. Before telephoning, make a note of the make, model and date of purchase of your machine: the Service Department will require this information.

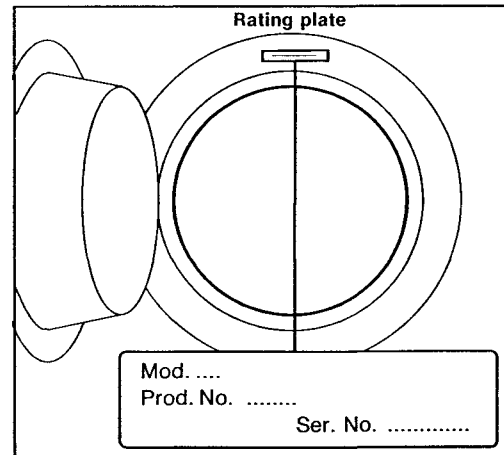

# TRICITY BENDIX

## GUARANTEE CONDITIONS

We, Tricity Bendix, undertake that if within 12 months of the date of the purchase this Tricity Bendix appliance or any part thereof is proved to be defective by reason only of faulty workmanship or materials, we will, at our option repair or replace the same FREE OF ANY CHARGE for labour, materials or carriage on condition that:

- The appliance has been installed correctly and used only on the electricity supply stated on the rating plate.
- The appliance has been used for normal domestic purposes only, and in accordance with the manufacturer's operating and maintenance instructions.
- The appliance has not been serviced, maintained, repaired, taken apart or tampered with, by any person not authorised by us.

All service work under this guarantee must be undertaken by a Tricity Bendix service representative or authorised agent.

Any appliance or defective part replaced shall become the property of Tricity Bendix.

This guarantee is in addition to your statutory and other legal rights.

Home visits are made between 8.30 am and 5.30 pm Monday to Friday. Visits may be available outside these hours in which case a charge will be made.

### EXCLUSIONS

This guarantee does not cover:

- Damage or calls resulting from transportation, improper use or neglect, the replacement of any light bulbs or removable parts of glass or plastic, or vacuum cleaner drive belts, brushes or dust bags.
- Costs incurred for calls to put right an appliance which is improperly installed or calls to appliances outside the United Kingdom.
- Appliances found to be in use within a commercial environment, plus those which are subject to rental agreements.
- Products of Tricity Bendix manufacture which are not marketed by Tricity Bendix.
- EEC Countries. The standard guarantee is applicable but subject to the owners responsibility and cost to ensure the appliance meets the standards set by the country to which the product is taken. Proof of purchase may be required. Electrolux Aftersales Service in the country concerned, with whom Tricity Bendix have an arrangement, will be pleased to advise further.

**Tricity Bendix After Sales Service - Service Centre Addresses 13/01/94**

<b>CENTRE</b>	<b>POSTAL DISTRICTS</b>	<b>SERVICE APPOINTMENTS</b>	<b>ADDRESS</b>
<b>ABERDEEN</b>	AB	0244-696569	Tricity Bendix After Sales Service Northeast Appliance Service 8 Cornhill Arcade Cornhill Drive Aberdeen AB2 5UT
<b>ARGYLLE</b>	PA 24-61	0505-321316	Tricity Bendix After Sales Service T.D.C. Refrigeration 40 Arran Place LInwood Renfrewshire PA3 3QU
<b>BARNSTAPLE</b>	EX 18-23, 31-39	0271-328826	Tricity Bendix After Sales Service McBain Refrigeration Unit 4 Upcott Avenue Pottington Industrial Estate Barnstaple N. Devon EX31 1HN
<b>BORDERS</b>	TD	0573-224411	Tricity Bendix After Sales Service James Stewart & Son 2-8 Wood Market Kelso Borders TD 5 7AX
<b>BOURNE</b>	PE 1-15 PE 34,38 NG 31-34	0778-394424	Tricity Bendix After Sales Service Bourne Electrical Pinfold Road Manning Road Industrial Estate Bourne Lincolnshire PE 10 9HT
<b>CANVEY</b>	E EC EN N NW W WC AL CB HA LU MK SG UB WD IP NR CM CO IG RM SS PE 16-19, 30-33, 35-37	081-443-3464 081-965-9699 081-9659699 0268-694144 0268-694144	Tricity Bendix After Sales Service 2-4 Sandhurst Kings Road Canvey Island SS8 0QY
<b>CARDIFF</b>	CF NP 1-4, 6, 9-44 SA 1-18 SA 21-32	0222-460131	Tricity Bendix After Sales Service Guardian Industrial Estate Clydesmuir Road Tremorfa Cardiff CF2 2QS
<b>CUMBRIA</b>	CA	0288-594747	Tricity Bendix After Sales Service E.T.B. Services Carlisle Enterprise Centre James Street Carlisle CA2 5AP
<b>DUMFRIES &amp; GALLOWAY</b>	DG 1-14	0387-65166	Tricity Bendix After Sales Service Allan Crossan (Service) 93 Irish Street Dumfries Scotland

Tricity Bendix After Sales Service - Service Centre Addresses 13/01/94

CENTRE	POSTAL DISTRICTS	SERVICE APPOINTMENTS	ADDRESS
<b>DUNDEE</b>	DD1-14 PH8-18	0250-876285	Tricity Bendix After Sales Service 1 Brogan Domestic 1 Lochinblair Gardens Dunkeld Road Blairgowrie Perthshire PH10 6GA
<b>FIFE</b>	KY1-16 PH1-7	0592-610590	Tricity Bendix After Sales Service M & H Appliances 8 Eddison House Fullerton Road Queensway Industrial Estate Glenrothes Fife KY7 5QR
<b>GLASGOW</b>	G KA ML PA1-23 EH FK ZE	041-647-4381	Tricity Bendix After Sales Service 20 Cunningham Road Clyde Estate Rutherglen Glasgow G73 1PP
<b>GUERNSEY</b>	All Codes	0481-46931	Guernsey Electricity PO Box 4 Vale Guernsey Channel Island
<b>HAVERFORDWEST</b>	SA33-39 SA41-44 SA61-73	0473-710914	Tricity Bendix After Sales Service C Butherway 1 Church Road Roch Haverfordwest Dyfed Wales SA 62 6AG
<b>HEREFORD</b>	HR1-9 LD1-8 SY7, 18 NP5, NP7-8	0432-340334	Tricity Bendix After Sales Service Domestic Repair Centre Unit 3 Bank Buildings Cattle Market Hereford HR4 9HX
<b>HULL</b>	YO4 YO11-18 YO25 HU1-19 DN14	0482-585678	Tricity Bendix After Sales Service John Sizer Unit 1 Boulevard Unit Factory Estate Hull HU3 4AY
<b>INVERNESS</b>	IV1-28, 30-36, 40-49, 51-56 PH19-26, 30-44 KW1-14	0463-792952	Tricity Bendix After Sales Service Highland Appliances Unit 3B3 Smithton Industrial Estate Smithton Inverness
<b>ISLE OF WIGHT</b>	PO30-41	0983-872552	Tricity Bendix After Sales Service Wyatts Electrical Service 4 Forelands Road Bembridge Isle of Wight PO35 5XW

**Tricity Bendix After Sales Service - Service Centre Addresses 13/01/94**

<b>CENTRE</b>	<b>POSTAL DISTRICTS</b>	<b>SERVICE APPOINTMENTS</b>	<b>ADDRESS</b>
<b>JERSEY</b>	All Codes	0534-505050	Tricity Bendix After Sales Service PO Box 45 Queens Road St Helier Jersey, Channel Islands JE4 8NY
<b>LAMPETER</b>	SA19, 20 SA 40 SA45-48 SY23-25	0570-423020	Tricity Bendix After Sales Service Lampeter Domestic Appliance Service Unit 16 Lampeter Industrial Estate Lampeter SA48 7DY
<b>LANCASTER</b>	LA1-23	0772-316175	Tricity Bendix After Sales Service NL Services Unit 333 Ranglet Road Walton Summit Bamber Bridge Preston Lancs PR5 8AR
<b>LEEDS</b>	BD DN1-7, 10-12 HD HG HX LS S WF YO1-3, 5-8 DE NG1-22, 25	0532-608511	Tricity Bendix After Sales Service 64-66 Cross Gates Road Leeds LS15 7NN
<b>LINCOLN</b>	DN21 subcodes 1, 2 & 5 only LN1, 2, 4-6 LN3 subcodes 4 & 5 only LN8-10 NG23, 24 PE20-25	0522-514603	Tricity Bendix After Sales Service Brian Hudson Unit 8 Stonefield Park Clifton Street Lincoln LN 5 8AA
<b>NEWTON ABBOTT</b>	EX1-17 PL1-9, 16, 19-21 TQ	0626-65909	Tricity Bendix After Sales Service South West Domestic Service Unit 2 Zealley Industrial Estate Kingsteighnton Newton Abbott South Devon TQ12 3SJ
<b>NORTH WALES</b>	LL	0745-591616	Tricity Bendix After Sales Service GMS (Cymru) Unit 2 Coed - Parc Abergele Road Rhuddlan Clwyd LL18 5UG
<b>NORTHERN</b>	DL TS DH YO21, 22 DN NE SR FY PR WN BB BL M OL SK CH CW L WA	0325-301400 091-493-2025 0282-774621 0282-774621 051-2541724	Tricity Bendix After Sales Service PO Box 40 Preston Road Aycliffe Industrial Estate Newton Aycliffe, Co Durham DL5 6XA
<b>NORTHERN IRELAND EAST</b>	BT1-30, 36-57, 63-67	0232-746591	Tricity Bendix After Sales Service Unit C3 Edenderry Industrial Estate 326 Crumlin Road Belfast BT14 7EE

Tricity Bendix After Sales Service - Service Centre Addresses 13/01/94

CENTRE	POSTAL DISTRICTS	SERVICE APPOINTMENTS	ADDRESS
<b>NORTHERN IRELAND WEST</b>	BT31-35, 60-62 BT68-82, 92-94	0861-510400	Tricity Bendix After Sales Service G & O (Armagh) Service Owenmore House Kilwee Business Park Upper Dunmurray Lane Belfast BT17 0HD
<b>NUNEATON</b>	B DY ST TF WR WS WV GL HP NN OX RG SL SN CV LE	021-358-7076 021-358-5051 0993-704411 0203-354424	Tricity Bendix After Sales Service Unit 23-24 Alliance Business Park Townsend Drive Nuneaton Warwickshire CV11 6RX
<b>REDRUTH</b>	TR1-20, 26, 27 PL10-15, 17, 18, 22-35	0209-314407	Tricity Bendix After Sales Service Cornwall Domestic Service Unit 7D Pool Industrial Estate Wilson Way Redruth, Cornwall TR15 3QW
<b>SHREWSBURY</b>	SY1-6 SY8-17 SY19-22	0743-450279	Tricity Bendix After Sales Service BLI Service 6 Harlescott Barn Harlescott Lane Shrewsbury SY1 3SY
<b>SOUTH HUMBERSIDE</b>	DN8, 9 DN15-20 DN21 subcodes 3, 4 only DN31-40 LN3 subcode 6 only 7 LN11-13	0472-267978	Tricity Bendix After Sales Service John Robinson (Electrical) Unit 74 New Enterprise Centre King Edward Street Great Grimsby DN31 3JP
<b>SOUTHERN</b>	BN16-18 BH DT SO SP BA BS PO1-22 TA TR21-25	0705-667411 0705-667411 0272-211876	Tricity Bendix After Sales Service Limerline Road Hilsea Portsmouth, Hampshire PO3 5JJ
<b>TONBRIDGE</b>	CT DA ME SL GU1-26 TN BN1-15 RH TW BR CR SE SW SM KT	0732-357722 0732-694341 081-658-9069	Tricity Bendix After Sales Service 61-63 High Street Tonbridge Kent TN9 1SD

# **TRICITY BENDIX**

Better Products. Better Value.

Tricity Bendix, 99 Oakley Road, Luton, Beds LU49QQ

Model No.  
**AW 410**

A DIVISION OF EMACO LIMITED.  
REGISTERED IN ENGLAND NO. 176547  
TW 1 2 3 4 5 6 7 8 9 10 11 12/95

Part No.  
**12499.5936**