

# ELECTRIC FRONT LOAD DRYER

EIED200QSW

With IQ-Touch™ Electronic Controls



White

*Pedestals Shown in Available Colors.*

## PRODUCT DIMENSIONS

Height	33-1/2"
Width	24"
Depth	24"

## MORE EASY-TO-USE FEATURES

### 4.0 CU. FT. CAPACITY

Accomplish more with extra large capacity.

### IQ-TOUCH™ CONTROLS

Unique knobless controls and intuitive design offer clean, sleek style to fit any space and provide easy operation.

### GENTLE DRY

Advanced drying technology uses lower heat temperatures to be more gentle on your clothes, protecting them from over-drying, shrinking, and wrinkling.

### DELAY START

Lets you be flexible with your time and still have laundry done when you want it done.

### 3 TEMPERATURE SETTINGS

Multiple options for achieving the perfect dry.

### STAINLESS STEEL TUB

Durable tub allows for long-term use and quiet operation.

Available in:



White (SW)

## SIGNATURE FEATURES

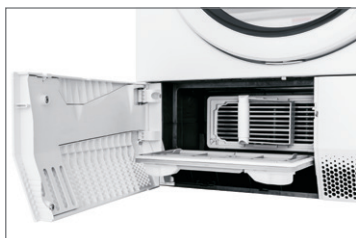

### VENTLESS MODEL

Condensation dryer allows you to have a perfect clean in any space and installation is easy. Eco-friendly unit that doesn't recycle heat from your home. Direct drain kit included.



### REVERSE TUMBLE

Alternates directions during dry load to reduce tangling/wrinkling of clothes and improve overall performance.



### REVERSIBLE DOOR

Offers maximum flexibility of any space and easy transfer of clothes from washer to dryer.



### 7 DRY CYCLES

Including Wrinkle Release and Delicate Cycle.

# ELECTRIC FRONT LOAD DRYER

EIED200QSW



## 24" ELECTRIC FRONT LOAD DRYER

Capacity D.O.E.	4.0 Cu.Ft.
-----------------	------------

### FEATURES

Pull-to-Open Door	Yes
iQ-Touch™ Electronic Controls	Yes
Dry System	Condensing
LED Lighting	Yes
Tumble System	Reversing
Moisture Sensor	Yes
Dryer Drum	Stainless Steel
Reversible Door	Yes
Adjustable Leveling Legs	Yes

### CYCLES

Normal, Heavy Duty, Delicates, Casual, Mixed Load, Touch Up, Towels;	7 Dry;
Jeans, Fast Dry, Wool, Timed Dry	4 Specialty

### OPTIONS

Temperature Selections	3
Electronic Auto Dry System	Yes
Manual Timed Dry Selections	11
Delay Start	Yes
End-of-Cycle Chime On/Off	Yes
Wrinkle Release	Yes
Dryness Levels	4

### INSTALLATION OPTIONS

Freestanding, Under Counter, Stacked (Above Washer), Pedestal, Recessed Alcove	Yes
--	-----

### ACCESSORIES

Pedestal – White – PN# EPWD200QSW	Optional
Dryer Stacking Kit – PN# STACKIT24	Optional
Direct Drain Kit	Included
Drying Rack – (PN# 916093163)	Optional

### SPECIFICATIONS

Color – White	SW
Power Supply Connection Location	Right Top Rear
Voltage Rating	208/240 VAC
Connected Load (kW Rating) @ 208/240 Volts	2800 W
Amps @ 208/240 Volts	16
Heating Element @ 208/240 Volts (Watts)	1,200
Shipping Weight (Approx.)	125 Lbs.

NOTE: Always consult local and national electric and plumbing codes. Refer to Product Installation Guide for detailed installation instructions on the web at [electroluxappliances.com](http://electroluxappliances.com). Specifications subject to change.

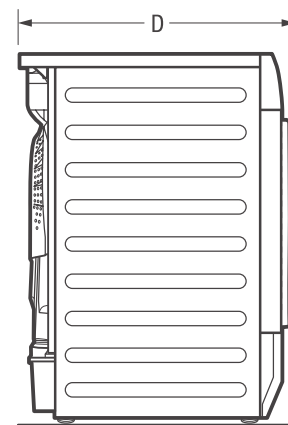
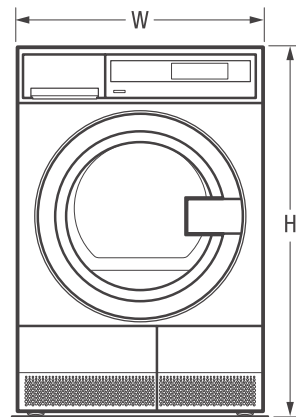

### PRODUCT DIMENSIONS

Height (without 12" Pedestal)	33-1/2"
Height (with 12" Pedestal)	46"
Width	24"
Depth (to Center of Arc Not Including Hose)	24"
Depth (with Door 90° Open)	43"

## Electrolux Major Appliances, N.A.

USA • 10200 David Taylor Drive • Charlotte, NC 28262 • 1-877-4electrolux (1-877-435-3287) • [electroluxappliances.com](http://electroluxappliances.com)  
 CANADA • 5855 Terry Fox Way • Mississauga, ON L5V 3E4 • 1-800-265-8352 • [electroluxappliances.ca](http://electroluxappliances.ca)

EIED200Q 11/14

© 2014 Electrolux Home Products, Inc.



High standards of quality at Electrolux Home Products, Inc. mean we are constantly working to improve our products. We reserve the right to change specifications or discontinue models without notice.

# ELECTRIC FRONT LOAD DRYER

EIED200QSW

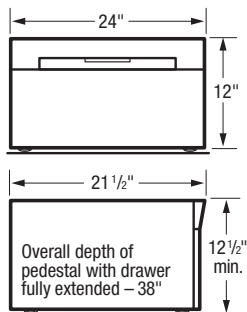
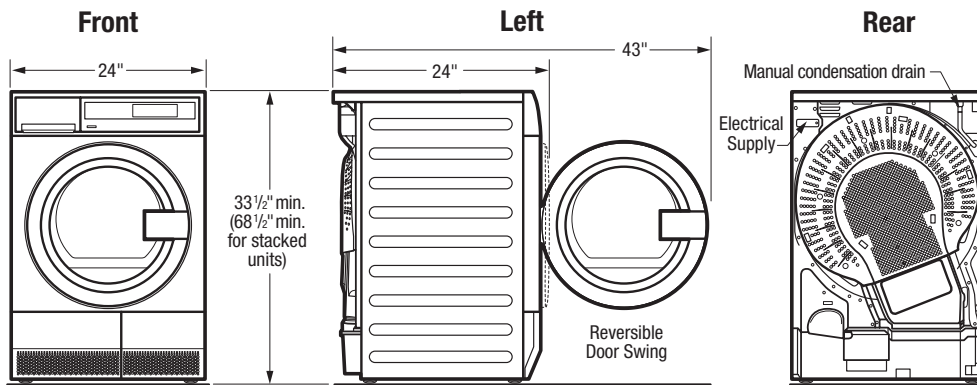

## 12" Pedestal Drawer Installation

Elevates dryer height to 46". For detailed pedestal installation, refer to instructions included with pedestal or on web.

## Built-In Installations

For built-in installations, NO minimum clearance required around sides, backs and tops of units. Location of plumbing and utility hookups MUST be considered in built-in installations. For additional installation details, refer to Product Installation Guides on web.

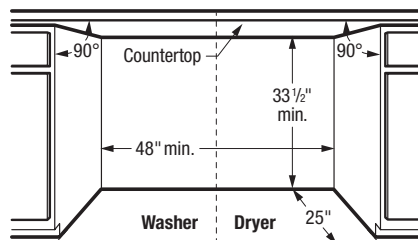

Side-by-Side Units in Under-Counter Installation

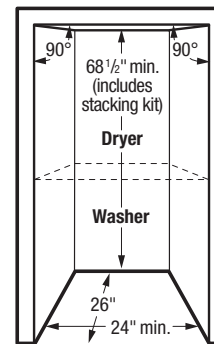

## Stacked Units in Recessed Alcove Installation

For detailed stacked installation, refer to instructions included with Stacking Kit or on web. **Note:** Stacking Kit adds 1" to overall depth of stacked units.

## Electric Dryer Specifications

- Product Weight – 119 Lbs.
- Condensation Dryer requires electrical hookup with no ventilation exhaust needed. Condensation is removed via manual condensation drain hose to inner reservoir (*to be removed manually*), or by draining directly into washer's standpipe with use of supplied Direct Condensation Drain Hose Kit. (*Refer to Direct Drain Option Specifications for drainage details.*)
- Voltage Rating – 208/240VAC
- Single phase 3- or 4-wire cable, 208/240 Volt, 60 Hertz AC only electrical supply with ground required on separate circuit fused on both sides of line. (*Do not use same circuit as washer.*)
- Connected Load (kW Rating) @ 208/240 Volts = 2.8 kW
- Amps @ 208/240V = 16A
- Dryer MUST employ a 3-conductor NEMA 10-30 type SRDT or 4-conductor NEMA 14-30 type SRDT or ST (as required), rated at 240 volt AC minimum, 30 amp power supply cord marked for use with clothes dryers (*not supplied*).
- Grounding through neutral link prohibited in specific applications and certain locales, requiring use of 4-wire system. (*For detailed electrical requirements, refer to Product Installation Guide on web.*)
- Always consult local and national electric & plumbing codes.
- Can be installed alone, with or without optional 12" pedestal drawer, or stacked above matching Electrolux Washer, which requires installation of optional dryer stacking kit. (*For installation details, refer to instructions included with optional pedestal or stacking kit or on web.*)

- Can be built in with matching Electrolux Washer in under-counter or recessed alcove installation with NO minimum clearance required around sides, backs and tops of units. (*Refer to Built-In Installations on this page for cutout dimensions. For additional installation details, refer to Product Installation Guide on web.*)
- Do NOT install in area exposed to dripping water or outdoor weather conditions, or where gasoline or other flammables are kept or stored.
- For garage installation, dryer MUST be located minimum 18" above floor.
- Floor MUST be solid with 1" maximum slope. To ensure vibration or movement does not occur, reinforcement of floor may be necessary. Do NOT install on carpeted surface.
- Leveling legs supplied to level dryer properly and reduce excessive noise and vibration.

## Direct Drain Option Specifications

- When using Direct Condensation Drain Hose Kit (*supplied*) to drain condensation directly into washer's standpipe, distance from bottom of drain hose sag to top of highest part of drain hose should be 20" max. with drain height located 40" max. above bottom of dryer's leveling legs.

**Note:** For planning purposes only. Refer to Product Installation Guide on the web at [electroluxappliances.com](http://electroluxappliances.com) for detailed instructions.

## Optional Accessories

- Pedestal Drawer – (PN # EPWD200QSW).
- Dryer Stacking Kit – (PN # STACKIT24).
- Drying Rack – (PN # 916093163).

## Electrolux Major Appliances, N.A.

USA • 10200 David Taylor Drive • Charlotte, NC 28262 • 1-877-4electrolux (1-877-435-3287) • [electroluxappliances.com](http://electroluxappliances.com)  
 CANADA • 5855 Terry Fox Way • Mississauga, ON L5V 3E4 • 1-800-265-8352 • [electroluxappliances.ca](http://electroluxappliances.ca)

EIED200Q 11/14

© 2014 Electrolux Home Products, Inc.



High standards of quality at Electrolux Home Products, Inc. mean we are constantly working to improve our products. We reserve the right to change specifications or discontinue models without notice.