



**VistaFrame™**  
***User's Guide VF-100 Series***

For the latest tips, special offers, and easy online registration, visit [www.vialta.com/owners](http://www.vialta.com/owners)



Please read this User's Guide.

  
**Vialta®**  
[www.vialta.com](http://www.vialta.com)



# Table of Contents

Important Safety Precautions .....	3
Introduction.....	4
What's Included with your VistaFrame .....	4
Setting up your VistaFrame .....	5
Locating VistaFrame's Features.....	6
Using VistaFrame's Features .....	8
Brightness Adjustment .....	8
My Album .....	8
Power Saving Mode .....	8
Motion Sensor .....	8
Power Button .....	9
Menu Button .....	9
Save Button .....	9
Slideshow Button .....	10
Rotate Button .....	10
Directional Buttons .....	10
Select Button .....	10
Exit Button .....	10
4-in-1 Memory Card Slot .....	11
Insert a Memory Stick®, SD™, or MultiMediaCard™ .....	11
Insert a SmartMedia™ Card .....	12
CompactFlash® Card Slot .....	12
Insert a CompactFlash® Card .....	12
Displaying Pictures with VistaFrame .....	13
Displaying Pictures Using the Menu Button .....	13
Saving Pictures with VistaFrame.....	16
Saving Pictures from a Memory Card .....	16
Replacing a Picture in My Album .....	18
Displaying a Slideshow on VistaFrame .....	19
Saving a Picture During a Slideshow .....	20
Pausing and Resuming a Slideshow .....	20
Changing Settings .....	20
Power Saving .....	20
Changing the Interval Between Slides .....	22
Choosing a Transition Type .....	23

Setting Slideshow to Play Once or Repeat .....	24
Erasing Pictures from My Album .....	25
Creating a Custom Slideshow .....	26
Create/Edit Custom Slideshow .....	26
Playing a Custom Slideshow .....	28
Tips.....	29
Custom Slideshow Tip .....	29
My Album Tip .....	29
Compatibility.....	30
Care and Maintenance.....	31
Troubleshooting Guide.....	32
Specifications .....	32
Service .....	33
Limited Warranty .....	34
Electronic Emission Notices.....	35
FCC Part 15 Information .....	35
CE Statement .....	35

# Important Safety Precautions

Always follow these basic safety precautions when using your VistaFrame. This will reduce the risk of fire, electric shock, and injury.

- Unplug VistaFrame from the power outlet before performing care and maintenance.
- Should any object or liquid fall into the housing, unplug VistaFrame and have it checked by qualified personnel before operating it again.
- Do not use VistaFrame near water or when you are wet.
- Slots and openings on the VistaFrame are for ventilation to prevent overheating. Do not cover them up.
- Do not place VistaFrame near a heat source or in direct sunlight.
- Do not disassemble VistaFrame. There are no user-serviceable parts inside.  
**Disassembly of VistaFrame will void your warranty.**
- Only use the AC power adapter included with VistaFrame. **Using any other power adapter will void your warranty.**

# Introduction

Welcome to VistaFrame. Now you can display your digital pictures directly from a memory card without the need for a computer. Simply insert a memory card into a card reader slot and select a single picture for a continuous viewing or create your own Custom Slideshow. VistaFrame supports CompactFlash®, Memory Stick®, SmartMedia™, SD™, and MultiMediaCard™

Do you want to save some pictures directly to your VistaFrame? No problem! VistaFrame allows you to store up to eight digital pictures in its internal memory (**My Album**).

To learn more about VistaFrames features and to get the maximum benefit from your new VistaFrame. Please take a few minutes to read this User's Guide. Also, please fill out the enclosed Warranty Card and mail it to Vialta, to activate your product warranty. As a convenient option you can also register online at [www.vialta.com/owners](http://www.vialta.com/owners).

## What's Included with your VistaFrame

Everything you need to begin using your VistaFrame is included in the package:

- One VistaFrame
- AC Power Adapter
- This User's Guide
- Warranty Card

# Setting up your VistaFrame

You can use your VistaFrame in any location, as long as a power outlet is available.

- 1) Plug the AC power adapter's pin into the **POWER IN** jack on the back of your VistaFrame.
- 2) Plug the power cord into a wall socket.
- 3) Press the **POWER** button on the back of VistaFrame to turn VistaFrame on.

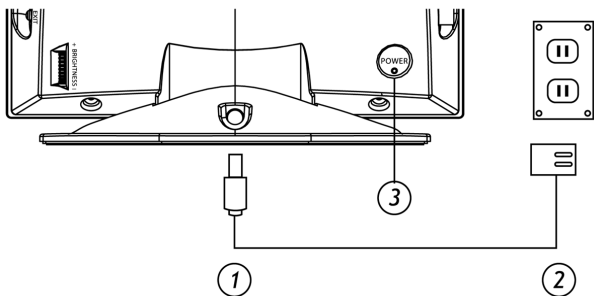

Your screen will briefly display the message “VistaFrame is now ready” to let you know that it is ready for you to insert a memory card.

# Locating VistaFrame's Features

Your VistaFrame places everything you need right at your fingertips.

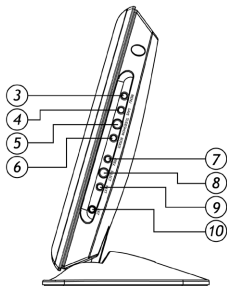
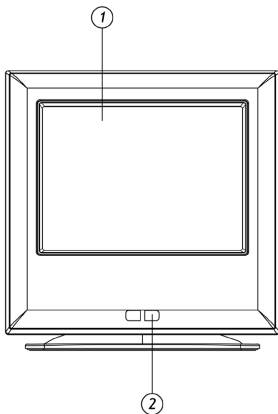

- |                           |                                 |
|---------------------------|---------------------------------|
| <b>1</b> Screen           | <b>6</b> Rotate Button          |
| <b>2</b> Motion Sensor    | <b>7</b> Prev (Previous) Button |
| <b>3</b> Menu Button      | <b>8</b> Select Button          |
| <b>4</b> Save Button      | <b>9</b> Next Button            |
| <b>5</b> Slideshow Button | <b>10</b> Exit Button           |



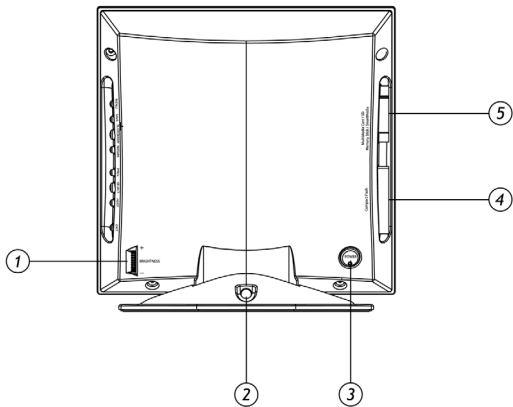

- 1 Brightness Adjustment
- 2 Power In
- 3 Power Button
- 4 CompactFlash® Card Slot
- 5 4-in-1 Memory Card Slot

# Using VistaFrame's Features

The following section describes your VistaFrame features.

## Brightness Adjustment

You can adjust the brightness of the screen with the scroll wheel on the back of your VistaFrame.

## My Album

VistaFrame can save up to 8 pictures in its internal memory. Pictures saved in My Album can be viewed even if you remove the memory card.

## Power Saving Mode

VistaFrame has a power saving mode that will automatically turn off the LCD screen after 120 minutes of inactivity (no movement detected or button pressed for 120 minutes). You can wake VistaFrame from power saving by pressing any button or if the motion sensor detects any movement. (See *Power Saving* on page 20 to disable power saving).

## Motion Sensor

VistaFrame uses a motion sensor located on the front of VistaFrame to wake from power saving mode. Slowly wave your hand 4-6 inches away from the sensor to wake VistaFrame up and continue displaying the previous picture(s).

## Power Button

Turn on your VistaFrame by pressing the **POWER** button. The LED located on the **POWER** button will light up when the power is on.

## Menu Button

Press the **MENU** button to display the Menu. By selecting View Pictures, you can access My Album or memory card pictures. From the Menu you can also create or play a Custom Slideshow, Change Settings, and Erase Pictures from My Album.



**Menu Screen**

## Save Button

Press the **SAVE** button to save JPEG pictures from a memory card into My Album.

## Slideshow Button

Press the **SLIDESHOW** button to start, pause or resume playing a slideshow. VistaFrame's slideshow feature displays pictures one after the other. (See *Displaying a Slideshow on VistaFrame* on page 19.)

## Rotate Button

Press the **ROTATE** button to turn the current picture clockwise 90 degrees. Continue to press the button until the picture is displayed properly. You will not be able to use the rotate feature while playing a slideshow or while displaying thumbnails.

## Directional Buttons

The **PREV (PREVIOUS)** and **NEXT** buttons, above and below the **SELECT** button, move the yellow highlight box to a different position. Using the directional buttons during a slideshow will immediately display the next or previous picture.

## Select Button

Use the **SELECT** button to choose a highlighted thumbnail or option on your VistaFrame.

## Exit Button

Press the **EXIT** button to stop the current action and return to the previous display. Pressing the **EXIT** button while the Menu is displayed will put VistaFrame in power-saving mode.

## 4-in-1 Memory Card Slot

VistaFrame can display pictures from several types of memory cards. The 4-in-1 memory card slot can read the following types of memory cards: Memory Stick®, SmartMedia™, SD™, and MultiMediaCard™.

If the card doesn't slide in easily, or VistaFrame doesn't read the card, remove the card. Make sure the label is facing you and the notched corner is pointing toward the side of VistaFrame and try inserting the card again.

*Note: The 4-in-1 reader only reads one memory card at a time. Do not insert more than one card into the memory card slot or damage may occur.*

*Note: If you insert your memory card directly from your digital camera, most cameras will put the pictures in a folder under the DCIM folder. Please check with your camera's user guide for more information.*

### **Insert a Memory Stick®, SD™, or MultiMediaCard™**

- 1) With VistaFrame's display facing you, hold the memory card with the label facing you and the notched corner pointing toward VistaFrame.
- 2) Gently slide the card into the 4-in-1 memory card slot on the side of VistaFrame. The card should slide in easily and VistaFrame should display "Loading".

## ***Insert a SmartMedia™ Card***

*Note: SmartMedia™ cards are very thin. It is a good idea to steady VistaFrame with one hand and carefully slide the card into the slot with the other hand.*

- 1) With VistaFrame's display facing you, hold the SmartMedia™ card with the metal contacts facing you and the notched corner pointing toward VistaFrame.
- 2) Gently slide the card into the 4-in-1 memory card slot on the side of VistaFrame. The card should slide in easily and VistaFrame should display "Loading".

## **CompactFlash® Card Slot**

VistaFrame's CompactFlash® Card Slot can display pictures from Type I CompactFlash® cards.

## ***Insert a CompactFlash® Card***

- 1) With VistaFrame's display facing you, hold the CompactFlash® card with the label facing you and with the pinholes pointing toward VistaFrame.
- 2) Gently slide the card into the CompactFlash® card slot on the side of VistaFrame. The card should slide in easily and VistaFrame should display "Loading".

If the card doesn't slide in easily, or VistaFrame doesn't read the card, remove the card. Make sure the label is facing you and the pinholes are facing the side of VistaFrame and try inserting the card again.

# Displaying Pictures with VistaFrame

VistaFrame can display pictures from My Album or a memory card, as thumbnails or as full-sized pictures. You can automatically display thumbnails of the pictures on a memory card by simply inserting the card into VistaFrame. If your memory card contains a combination of folders and pictures, VistaFrame will display thumbnails of all the folders first.

## Displaying Pictures Using the Menu Button

- 1) To display thumbnails from My Album or a memory card, press the **MENU** button, then highlight **VIEW PICTURES** and press the **SELECT** button.
  - If one or more memory cards are present, you will be prompted to choose a memory card type. Use the directional buttons to highlight a memory card type and press the **SELECT** button.

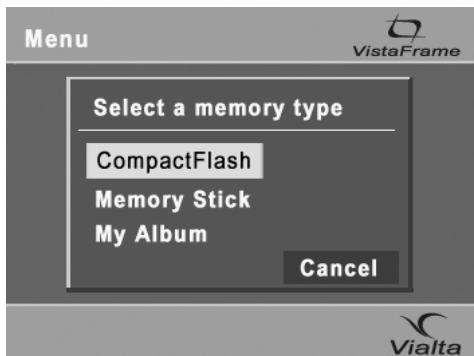

**Select Memory Type**

- If no memory cards are present, My Album opens and the first six pictures are displayed as thumbnails.
- The first six folders or pictures are displayed as thumbnails. The screen also shows information about the folders, pictures and memory card.



### Thumbnails Display

- Memory type is displayed in the upper left corner.
- The selected item number and the total number of items are shown in the bottom right corner.

*Note: If you insert your memory card directly from your digital camera, most cameras will put the pictures in a folder under the DCIM folder. Please check with your camera's user guide for more information.*



- 2) If a folder is highlighted, the name of the folder is shown in the bottom left corner. From the thumbnail view, you can open folders and choose a picture to display full-size.
- To open a folder, use the directional buttons to move the yellow highlight box to the desired folder. Press the **SELECT** button to open the folder and display any folders and pictures inside.
  - To choose a picture, use the directional buttons to move the yellow highlight box to the desired picture.
  - To display the next six thumbnails, press the **NEXT** button until the next screen of thumbnails appears.
  - To display the previous six thumbnails, press the **PREV** button until the previous screen of thumbnails appears.
  - To go back to the previous folder, highlight the folder with a bent arrow and press the **SELECT** button.
- 3) To display a full-sized picture, highlight a picture and press the **SELECT** button. The thumbnails are replaced with a full-sized picture.
- 4) To return to the thumbnail display, press the **EXIT** or **SELECT** button.

# Saving Pictures with VistaFrame

You can save up to 8 pictures from memory cards to My Album so you can view them later without the need for a memory card.

## *Saving Pictures from a Memory Card*

- 1) Insert a memory card into VistaFrame. The screen will show the first 6 folders or pictures on the card as thumbnails, with the yellow highlight box on the first picture or folder. The screen also shows information about the folders, pictures and memory card.

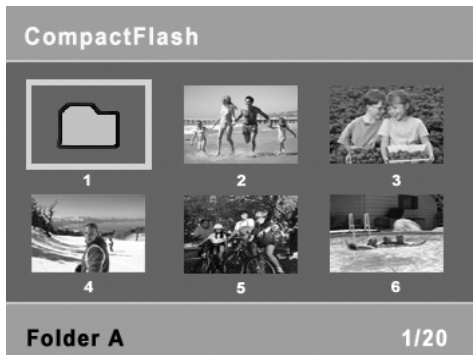

## **Saving Pictures from Memory Card**

- Memory type is displayed in the upper left corner.
- The selected item number and the total number of items are shown in the bottom right corner.
- The name of the highlighted folder is shown in the bottom left corner.

- 2) Choose a picture to save using the directional buttons to move the yellow highlight box to the desired picture.
  - To display the next six thumbnails, repeatedly press the **NEXT** button until the next screen of thumbnails appears.
  - If your pictures are saved in folders, use the directional buttons to move the yellow highlight box to the desired folder. Press the **SELECT** button to open the folder and display any folders and pictures inside. To go back to the previous folder, highlight the folder with a bent arrow and press the **SELECT** button.
- 3) Press the **SAVE** button. VistaFrame displays status messages while saving the picture. The picture is displayed full-size while being saved.
- 4) Once the picture is saved, you'll see a pop-up screen asking if you want to save another picture. Highlight **NO** and press the **SELECT** button to go back to the Menu screen. Highlight **YES** and press the **SELECT** button to save another picture.

You can save up to 8 pictures in My Album. If you already have 8 pictures saved, and you wish to save a new picture, you'll need to replace one of the pictures already in My Album.

## Replacing a Picture in My Album

If My Album is full and you try to save another picture, you'll see a message asking if you want to replace an existing picture.

- 1) Highlight **YES** and press the **SELECT** button to replace a picture. VistaFrame displays a page of thumbnails. The first picture, with a blue border, is the picture you are saving. The remaining are the first five pictures in My Album.

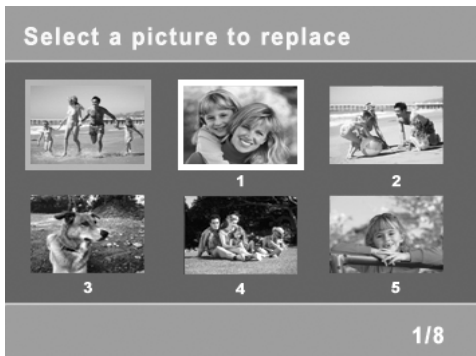

### Select Picture to Replace

- 2) Use the directional buttons to highlight a picture to replace. Press the **SELECT** button to replace the picture. A pop-up screen will ask you if you want to replace the picture.
- 3) Highlight **YES** to replace the picture or **NO** to go back to the previous screen and choose a different picture to replace. Press the **SELECT** button.

## Displaying a Slideshow on VistaFrame

VistaFrame can display the pictures in My Album or on a memory card as a slideshow. The slideshow plays all of the pictures in My Album, or all pictures located in a single folder on a memory card. To create a slideshow with pictures inside multiple folders on a memory card, see *Create/Edit Custom Slideshow* on page 26.

*Note:* Your VistaFrame loads lower resolution pictures more quickly.

### 1) Press the **SLIDESHOW** button.

- If a memory card is present and there are pictures in My Album, VistaFrame will ask you to choose a memory type. Use the directional buttons to highlight a memory type and press the **SELECT** button.
- If there are pictures in My Album and no memory card is present, the slideshow starts immediately.
- If there are no pictures in My Album and a memory card is present, VistaFrame will start playing the slideshow of pictures on your memory card.

*Note:* You can also display a slideshow of all pictures inside a folder on a memory card. Simply insert the memory card and open the desired folder. Then press the **SLIDESHOW** button.

### 2) Press the **EXIT** button to stop the slideshow and return to the thumbnails.

## Saving a Picture During a Slideshow

Press the **SAVE** button to save the current picture. VistaFrame displays status messages while saving the picture. When the picture is saved, the slideshow resumes.

## Pausing and Resuming a Slideshow

- 1) While a slideshow is playing, press the **SLIDESHOW** button to pause the slideshow.
- 2) Press the **SLIDESHOW** button again to resume playing the slideshow.

## Changing Settings

These settings let you choose whether the power saving mode is on or off, how long each picture is shown in a slideshow, the type of transition effect between pictures, and whether the slideshow repeats after displaying the last picture.

### Power Saving

You can select the length of time each slide is displayed during a slideshow.

- 1) Press the **MENU** button and highlight **CHANGE SETTINGS**. Press the **SELECT** button.
- 2) Highlight **POWER SAVING** and press the **SELECT** button. A red checkmark shows the current setting.

- 3) Choose **ON** to display the slideshow or single image for 120 minutes before going into power saving mode, or **OFF** to disable power saving mode and constantly display the slideshow or single image. Press the **SELECT** button.

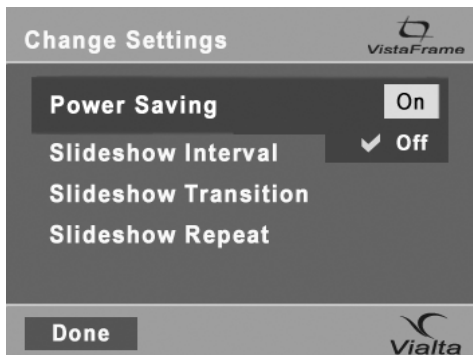

### Change Power Saving Settings

- 4) Highlight **DONE** and then press the **SELECT** button. This saves your new settings and returns you to the Menu screen.

*Note: The settings will not be saved unless you highlight **DONE** and press the **SELECT** button.*

## Changing the Interval Between Slides

You can select the length of time each slide is displayed during a slideshow.

- 1) Press the **MENU** button and highlight **CHANGE SETTINGS**. Press the **SELECT** button.
- 2) Highlight **SLIDESHOW INTERVAL** and press the **SELECT** button. A red checkmark shows the current interval.
- 3) Use the directional buttons to highlight **FAST**, **NORMAL**, or **SLOW**. Press the **SELECT** button.

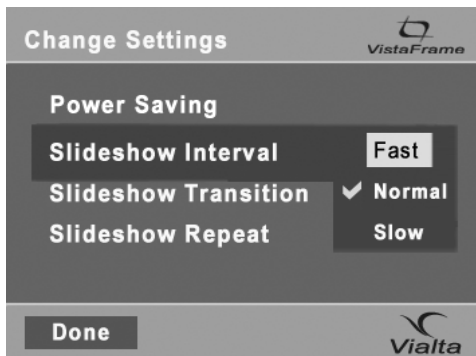

### Change Interval Settings

- 4) Highlight **DONE** and then press the **SELECT** button. This saves your new settings and returns you to the Menu screen.

*Note: The settings will not be saved unless you highlight **DONE** and press the **SELECT** button.*



## Choosing a Transition Type

- 1) From the **CHANGE SETTINGS** screen, highlight **SLIDESHOW TRANSITION**. Press the **SELECT** button. A red checkmark shows the current setting.
- 2) Choose a transition type for the slideshow. The choices are:

- Curtain



- Blooming

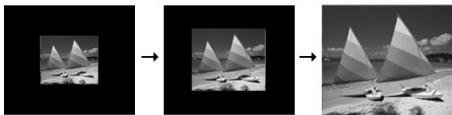

- Vertical Blinds



- 3) Press the **SELECT** button.
- 4) Highlight **DONE** and then press the **SELECT** button. This saves your new settings and returns you to the Menu screen.

*Note: The settings will not be saved unless you highlight **DONE** and press the **SELECT** button.*

## Setting Slideshow to Play Once or Repeat

You can choose to play the slideshow once, or repeatedly for up to 120 minutes.

- 1) From the **CHANGE SETTINGS** screen, highlight **SLIDESHOW REPEAT** and then press the **SELECT** button. A red checkmark shows the current setting.
- 2) Choose **ON** to play the slideshow in a continuous loop, or **OFF** to stop the slideshow after the last picture. Press the **SELECT** button.
- 3) Highlight **DONE** and then press the **SELECT** button. This saves your new settings and returns you to the Menu screen.

*Note: The settings will not be saved unless you highlight **DONE** and press the **SELECT** button.*

# Erasing Pictures from My Album

You can erase pictures from My Album at any time.

- 1) Press the **MENU** button and highlight **ERASE PICTURES FROM MY ALBUM**. Press the **SELECT** button. VistaFrame displays thumbnails of the first six pictures in My Album.



## Erasing Pictures

- 2) Use the directional buttons to highlight a picture to erase, and press the **SELECT** button. VistaFrame will ask you if you want to erase the picture.

To erase all pictures in My Album, highlight **ERASE ALL** and press the **SELECT** button. VistaFrame will ask you if you want to erase all of the pictures.

- Highlight **NO** to keep the selection and then press the **SELECT** button.

- Highlight **YES** to erase the picture and then press the **SELECT** button. The picture is erased. You can erase as many pictures as you wish, one at a time, in the same manner.
- 3) Press the **EXIT** button when you're finished to return to the Menu.

## Creating a Custom Slideshow

With a Custom Slideshow, you can choose the order in which to play specific pictures in a slideshow. You can even choose pictures from more than one folder on a memory card. You can create one Custom Slideshow for My Album and one for a memory card currently in VistaFrame.

Once you have created a Custom Slideshow use the **PLAY** feature of the Custom Slideshow. (See *Playing a Custom Slideshow* on page 28.)

*Note: A Custom Slideshow for My Album is saved until you change it. A Custom Slideshow from a memory card is only saved until the memory card is removed or power is interrupted.*

### Create/Edit Custom Slideshow

Use **CREATE/EDIT CUSTOM SLIDESHOW** to choose the pictures and play order of the slideshow.

- 1) Press the **MENU** button.
- 2) Highlight **CUSTOM SLIDESHOW** and press the **SELECT** button.
  - Highlight **CREATE/EDIT** and press the **SELECT** button.

- 3) Highlight a memory type, either My Album or a memory card, and press the **SELECT** button.
- The first six thumbnails are displayed. If your memory card contains a combination of folders and pictures, VistaFrame will display all folders first. To display the next six thumbnails, repeatedly press the **NEXT** button until the next screen of thumbnails appears.

*Note:* To open a folder, use the directional buttons to highlight the desired folder. Press the **SELECT** button to open the folder and display any folders or pictures inside.

- 4) Use the directional buttons to highlight a picture you want to include in the Custom Slideshow, and then press the **SELECT** button. A red checkmark appears under the picture.



### Create Custom Slideshow

*Note:* Pictures will play in the order you select them.

- To remove a picture from the Custom Slideshow, highlight the picture and then press the **SELECT** button. The red checkmark will disappear.
- 5) Repeat Step 4 to add or remove as many pictures as you wish to the Custom Slideshow.
    - To include all of the pictures in a folder, highlight **SELECT ALL**, and then press the **SELECT** button. To clear all selected pictures in a folder, highlight **CLEAR ALL** and then press the **SELECT** button.
  - 6) When you're finished adding all your pictures to the Custom Slideshow, highlight **DONE** and press the **SELECT** button.

*Note: The Custom Slideshow will not be saved unless you highlight **DONE** and press the **SELECT** button.*

## Playing a Custom Slideshow

- 1) Press the **MENU** button.
- 2) Highlight **CUSTOM SLIDESHOW** and press the **SELECT** button.
- 3) Highlight **PLAY** and then press the **SELECT** button.
  - Highlight a memory type and then press the **SELECT** button. VistaFrame displays the Custom Slideshow for the selected memory type.

# Tips

Lower resolution pictures will load from memory cards faster. To have your pictures load quicker, make sure the images on your memory card are lower resolution images.

## Custom Slideshow Tip

When selecting pictures to be included in your Custom Slideshow, some images may need to be rotated so that they are displayed in the way you want them to appear. Here is an easy way to quickly rotate them.

- 1) Play the Custom Slideshow and when a picture appears that you want to rotate, press the **SELECT** button to pause the slideshow.
- 2) Press the **ROTATE** button until the picture is displayed in the desired orientation.
- 3) Press the **SLIDESHOW** button to resume viewing the slideshow.

*Note: A Custom Slideshow, along with any rotation instructions, is saved until the memory card is removed or the power is turned off.*

## My Album Tip

If you want to save a picture from your memory card to My Album, in a different orientation than how it currently saved on your memory card, VistaFrame can do it in three easy steps.

- 1) Display in full size the picture that you want to save in My Album (See *Displaying Pictures with VistaFrame* on page 13).
- 2) Press the **ROTATE** button until the picture is displayed in the desired orientation.
- 3) Press the **SAVE** button to save the picture into My Album.

Every time you view the picture saved in My Album, it will be displayed in the orientation that you have chosen.

## Compatibility

VistaFrame only supports the JPEG picture format.

VistaFrame supports the following memory storage devices: SmartMedia™, CompactFlash® (Type I), SD™, MultiMediaCard™, and Memory Stick®.



## Care and Maintenance

To keep your Vialta VistaFrame working and looking good, follow these simple guidelines:

- Avoid putting your VistaFrame near heating appliances and devices that generate electrical noise. (For example, motors and fluorescent lamps.)
- Do not expose VistaFrame to direct sunlight or moisture.
- Clean your VistaFrame with a soft cloth. (Remember to unplug VistaFrame from the power outlet first.)
- Never use a strong cleaning agent or abrasive powder when caring for your VistaFrame, as this will damage the finish.
- Retain the original packaging for future use.
- Please visit us at **[www.vialta.com/owners](http://www.vialta.com/owners)** for more information.

# Troubleshooting Guide

<b>Problem</b>	<b>What to Do</b>
Display has tiny black or bright points.	This is a normal result of the manufacturing process, not a malfunction.
Only can see 6 pictures on a card.	Use the NEXT button to see the next 6 thumbnails.
Picture display seems slow.	Use lower resolution pictures.
VistaFrame doesn't display any pictures.	Make sure your memory card is inserted properly and that the pictures on it are in JPEG format. Pictures may be saved in a DCIM folder
VistaFrame doesn't display all my pictures.	VistaFrame is limited to 500 images per directory. Make sure that the pictures on the card are in JPEG format.
Black Screen	Be sure that the POWER LED is illuminated. Press any button to wake up VistaFrame.

## Specifications

<b>Display</b>	6.8" Active Matrix TFT LCD Adjustable Brightness
<b>Power</b>	Power Consumption 18 Watts Operating Voltage (AC adapter) 100-240VAC, 50/60HZ
<b>Supported memory devices</b>	CompactFlash® (Type I), SmartMedia™, SD™, MultiMediaCard™, Memory Stick®
<b>File Format</b>	JPEG
<b>Dimensions</b>	7.3 in (H) x 7.5 in (W) x 1.5 in (D)

## Service

For instructions on how to obtain service, refer to the warranty included in this guide or call Vialta Customer Care at 510-870-3198. Or send an email to: [support@vialta.com](mailto:support@vialta.com)

Attach your sales receipt to this booklet for future reference, or jot down the date this product was purchased, along with the name of the store. This information will be valuable if service should be required during the warranty period.

Purchase  
date \_\_\_\_\_

Name of  
store \_\_\_\_\_

Information contained in this User's Guide is subject to change at any time, and without notice.

Vialta®, VistaFrame™, Beamer™, Beamer TV™, and Beamer FX™ are registered trademarks or trademarks of Vialta, Inc. CompactFlash® is a registered trademark of SanDisk Corp. Memory Stick® is a registered trademark of Sony Corporation. SmartMedia™ and SD™ are a trademarks of Toshiba Corporation. MultiMediaCard™ is a trademark of MultiMediaCard Association. All trademarks are either registered trademarks or trademarks of their respective holders.

## Limited Warranty

### Vialta VistaFrame (VF-100 Series)

Be sure to keep your original sales slip. Attach it to this User's Guide and keep both accessible. Also, keep the original box and packing material in case you need to return your VistaFrame for service.

### Limited Warranty

Vialta, Inc. (Vialta) warrants this product against substantial defects in materials or workmanship to the original purchaser as follows:

**Labor:** Vialta will repair or replace this product, at its option and without charge, if it is determined to be defective, for a period of 90 days from date of purchase. After 90 days, labor charges will apply to all repair services.

**Parts:** In addition, Vialta will replace defective parts, without charge, for a period of one year from date of purchase. After 90 days, labor charges will apply to all repair services.

**Exclusions:** This warranty does not cover installation or setup charges. Cosmetic damage, unauthorized repair, acts of God, accidental damage, misuse, abuse, negligence, improper voltage, or customer modification of the unit are not covered. Any commercial use of this product will automatically void this warranty. This warranty is invalid if the factory applied serial number has been altered or obliterated.

IN NO EVENT SHALL VIALTA BE LIABLE OR IN ANY WAY RESPONSIBLE FOR DAMAGES OR DEFECTS IN THE PRODUCT CAUSED BY REPAIRS OR ATTEMPTED REPAIRS PERFORMED BY ANYONE OTHER THAN AN AUTHORIZED SERVICE REPRESENTATIVE. NOR SHALL VIALTA BE LIABLE OR IN ANY WAY BE RESPONSIBLE FOR ANY INCIDENTAL OR CONSEQUENTIAL ECONOMIC OR PROPERTY DAMAGE.

Because some states do not allow the exclusion or limitation of consequential or incidental damages, the above limitations may not apply to you. THIS WARRANTY GIVES YOU SPECIFIC LEGAL RIGHTS, AND YOU MAY ALSO HAVE OTHER RIGHTS WHICH MAY VARY FROM STATE TO STATE.

Proof of purchase, such as a bill of sale or receipted invoice that indicates that the unit is within the warranty period is required to obtain warranty service.

Warranty service will be provided when the product is returned to Vialta, in its original packaging and postage prepaid. For product return or customer questions, please call Vialta at 510-870-3198. Or send an email to [support@vialta.com](mailto:support@vialta.com).

# Electronic Emission Notices

## FCC Part 15 Information

This equipment has been tested and found to comply with the limits for a Class B digital device, pursuant to Part 15 of the Federal Communication Commission (FCC) Rules. These limits are designed to provide reasonable protection against harmful interference in a residential installation.

This equipment generates, uses, and can radiate radio frequency energy and if not installed and used in accordance with the instructions, may cause harmful interference to radio communications. However, there is no guarantee that interference will not occur in a particular installation. If this equipment does cause harmful interference to radio or television reception, which can be determined by turning the equipment off and on, the user is encouraged to try to correct the interference by one or more of the following measures:

- Reorient or relocate the receiving antenna.
- Increase the separation between the equipment and receiver.
- Connect the equipment to an outlet on a circuit different from that to which the receiver is connected.
- Consult the dealer or an experienced radio/TV technician for help.

## CE Statement

Products with the CE Marking comply with the EMC Directive (89/336/EEC) issued by the Commission of the European Community.

Compliance with the directive implies conformity to the following European Norms:

- EN 55022: 1998+A1: 2000
- EN 61000-3-2: 2000
- EN 61000-3-3: 1995+A1: 2001
- EN 55024: 1998+A1: 2001





## **Specials and Easy Registration**

For tips, the latest VistaFrame specials, and easy online registration, visit us at [www.vialta.com/owners](http://www.vialta.com/owners)

**[www.vialta.com](http://www.vialta.com)**



**Vialta, Inc.  
Fremont, California, USA  
11PG05-00003-B**

**©2004, by Vialta, Inc. All rights reserved.**



# Table of Contents

Important Safety Precautions .....	3
Introduction.....	4
What's Included with your VistaFrame .....	4
Setting up your VistaFrame .....	5
Locating VistaFrame's Features.....	6
Using VistaFrame's Features .....	8
Brightness Adjustment .....	8
My Album .....	8
Power Saving Mode .....	8
Motion Sensor .....	8
Power Button .....	9
Menu Button .....	9
Save Button .....	9
Slideshow Button .....	10
Rotate Button .....	10
Directional Buttons .....	10
Select Button .....	10
Exit Button .....	10
4-in-1 Memory Card Slot .....	11
Insert a Memory Stick®, SD™, or MultiMediaCard™ .....	11
Insert a SmartMedia™ Card .....	12
CompactFlash® Card Slot .....	12
Insert a CompactFlash® Card .....	12
Displaying Pictures with VistaFrame .....	13
Displaying Pictures Using the Menu Button .....	13
Saving Pictures with VistaFrame.....	16
Saving Pictures from a Memory Card .....	16
Replacing a Picture in My Album .....	18
Displaying a Slideshow on VistaFrame .....	19
Saving a Picture During a Slideshow .....	20
Pausing and Resuming a Slideshow .....	20
Changing Settings.....	20
Power Saving .....	20

Changing the Interval Between Slides .....	22
Choosing a Transition Type .....	23
Setting Slideshow to Play Once or Repeat .....	24
Erasing Pictures from My Album .....	25
Creating a Custom Slideshow .....	26
Create/Edit Custom Slideshow .....	26
Playing a Custom Slideshow .....	28
Tips.....	29
Custom Slideshow Tip .....	29
My Album Tip .....	29
Compatibility.....	30
Care and Maintenance.....	31
Troubleshooting Guide.....	32
Specifications .....	32
Service .....	33
Limited Warranty .....	34
Electronic Emission Notices.....	35
FCC Part 15 Information .....	35
CE Statement .....	35