

THOMSON

Thomson Lyra AV Jukebox User's Guide

PDP2860

It is important to read this instruction book prior to using your new product for the first time.

Important Information

WARNING

To reduce the risk of fire or electric shock, do not expose this product or AC charger to rain or moisture.

To reduce risk of injury, charge only rechargeable batteries recommended by the manufacturer for this product. Other types of batteries may burst causing damage and personal injury.

CAUTION

RISK OF ELECTRIC SHOCK DO NOT OPEN

To reduce the risk of electric shock, do not remove cover (or back). No user serviceable parts inside. Refer servicing to qualified service personnel.

Battery can only be repaired or replaced by qualified service personnel.



This symbol indicates "dangerous voltage" inside the product that presents a risk of electric shock or personal injury.



This symbol indicates important instructions accompanying the product.

Sound Pressure Control



Les articles de loi L44.5 et 44.6 du code de la santé publique, modifiés par l'article 2 de la loi du 28 Mai 1996 imposent une puissance acoustique maximale de 100 décibels. Le casque livré (code 55851980) et votre appareil respectent la législation en vigueur.

A pleine puissance, l'écoute prolongée du baladeur peut endommager l'oreille de l'utilisateur.

Service

This product should be serviced only by those specially trained in appropriate servicing techniques. For instructions on how to obtain service, refer to the warranty in this guide.

Product Registration

Please fill out the product registration card and return it immediately. Returning this card allows us to contact you if needed.

Product Information

Keep your sales receipt for proof of purchase to obtain warranty parts and service and attach it here. Record the serial number and model numbers — both numbers are located on the product.

Model No. _____ Serial No. _____

Purchase Date _____ Place of purchase _____

Chapter 1: Before You Begin

Things to consider before you get started...	3
Computer System Requirements	3
Warning	3
Caution	3
Caution While Driving	3
Back up your data	3
Important Battery Information	4
Check For Updates	4
Unpack the box and check your parts	5
What you want to know	5
Overview of buttons and jacks	6

Getting Started: Software Setup

Setup Information	8
Install software in your computer (Windows support only)	8
Insert the Included CD-ROM into CD-ROM Drive	8
Software Information	11
Transferring Files to Thomson Lyra AV Jukebox	12
Thomson Lyra Jukebox System Applications	13
Profile Device Contents (Audio only)	13
Updating System File	13
Verify User Playlists	14
LyraSync	14
Disconnecting Your Thomson Lyra from the Computer	15

Chapter 2: Using the Setup Menu

Setup Menu	16
Audio/Video Settings Menu	17
Photo Settings Menu	18

Chapter 3: Playing Files

Basic Information	19
Basic Screen Information	19
Basic Operation	19
Playing Video	20
Recording Video to Your Thomson Lyra AV Jukebox	21
From an Audio/Video Component	21
From Computer	22
Downloading Video to Your Thomson Lyra AV Jukebox	22
Viewing Video Content on Your TV	22

Table of Contents

Playing Audio	22
Audio Playback Screen	23
Recording Audio to Your Thomson Lyra AV Jukebox	24
From Stereo System	24
From Computer	24
Downloading Audio Files to Your Thomson Lyra AV Jukebox	24
Playing Your Thomson Lyra AV Jukebox in Your Car Stereo	25
Playing Your Thomson Lyra AV Jukebox on Your Stereo System	25
Viewing Photos	26
Downloading Photos From Computer	27
Creating Photo Slideshow	27
Viewing Photo Slideshow	27
Viewing Photos on Your TV	27
Viewing Files	28
Portable Hard Drive Capability	29
CompactFlash High-Speed Card Reader	29

Chapter 4: Additional Information

Tips and Troubleshooting	30
Specifications & System Requirements	31
Thomson Helpline	32
Repair Centers - Hungary	33
Repair Centers - Poland	34
Repair Centers - Russia	35
Repair Centers - Czech Republic	37

Disclaimer: This document may describe functionalities that are not currently implemented or available for the Thomson Lyra AV Jukebox. Please visit www.thomson-lyra.com for more information about the latest software and updates available for the Thomson Lyra AV Jukebox.

Things to consider before you get started...

Computer System Requirements

- Pentium III 500 MHz or higher recommended
Macintosh iMac G3 or higher
- Windows® 98SE, Me, 2000 with Service Pack 3, or XP
Mac OS X Version 10.1.5 or higher
- Internet Explorer 4.0 or higher
- Internet access
- 100 MB free hard disk space for the software
- 64 MB RAM (128 MB recommended)
- CD-ROM drive capable of digital audio extraction
- USB port (2.0 recommended)
- Installed sound card
- 16-bit color video card

File	Supported File Formats	Supported Video Codec Format
Audio	mp3	
Photos	JPEG, JPG	
Video	AVI	MPEG4- SP

Warning

Use of this product is for your personal use only. Unauthorized recording or duplication of copyrighted material may infringe upon the rights of third parties and may be contrary to copyright laws.

Caution

- Keep product out of direct sunlight. Exposure to direct sunlight or extreme heat (such as inside a parked car) may cause damage or malfunction.
- Do not expose to rain or moisture.

Caution While Driving

Use of headphones while operating an automobile or moving vehicle is not recommended and is unlawful in some states and areas. Be careful and attentive on the road. Stop operation of the unit if you find it disruptive or distracting while driving.

Back up your data

As with any device that has a hard drive or rotating magnetic media, you should back up the drive regularly. Thomson is not responsible for lost data.

Disclaimer: This document may describe functionalities that are not currently implemented or available for the Thomson Lyra AV Jukebox. Please visit www.thomson-lyra.com for more information about the latest software and updates available for the Thomson Lyra AV Jukebox.

Windows is a registered trademark of Microsoft Corporation in the United States and other countries.

Before You Begin





Things to consider before you get started... (continued)

Important Battery Information

- The battery used in this device may present a risk of fire or chemical burn if mistreated. Do not separately recharge, disassemble, heat above 100C (212F), or incinerate.
- Battery replacement should only be made by trained technicians. Refer to the Thomson Warranty Card for details.
- Do not attempt to open the unit. No user serviceable parts inside.
- Keep the unit away from children. Do not disassemble or dispose product in fire.
- Use only the specified chargers which were packaged with the product. Use of another charger may present a risk of fire or explosion.
- Keep charger plugged in to device for at least 30 minutes before attempting to operate device if battery is completely run down and is insufficient to power up device.

Check For Updates

Visit <http://www.thomson-lyra.com> for the latest news and firmware upgrades for the Thomson Lyra AV Jukebox. You must update your system after new downloads have been made in order for the new applications to be executed. Go to page 13 for details on profiling and updating system file pages.

What you want to know	Go to page ...
 Parts checklist — everything that was in the Thomson Lyra box	5
 Buttons — where they are and what they do	6
 Setup information — Step-by-Step instructions The Thomson Lyra QuickStart Guide (the printed foldout that came with your Thomson Lyra AV Jukebox) stepped you through the basics of installing software and downloading files. If you need more detail, you're in the right place — go to page 8 for step-by-step instructions.	8
 Operation — the details If the information on the printed QuickStart guide wasn't enough, this section gives you a little more detail about the basics of sorting and playing music on your Thomson Lyra AV Jukebox.	19
 Answers... to questions and solutions to problems — FAQ and Troubleshooting	30

Unpack the box and check your parts

Your Thomson Lyra AV Jukebox came with everything you need to make music portable- all of the items shown below should have been packed in the box with your Thomson Lyra AV Jukebox.

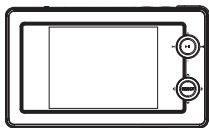

Thomson Lyra A/V Jukebox
 model number
 PDP2860



AC/DC adapter charger



Music Management CD
 contains the Thomson Lyra AV Jukebox Applications & MusicMatch Jukebox software



Ear Buds- plug into the Headphones jack on the side of the Thomson Lyra AV Jukebox



Carrying case



Line out cable — connects Thomson Lyra A/V Jukebox to a component, such as a TV, with video and audio capability. For details, go to Chapter 3.



Line in cable — connects Thomson Lyra A/V Jukebox to a component, such as a TV, with video and audio capability. For details, go to Chapter 3.

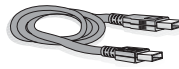

Mini USB cable
 Plug the small end into the USB port on the top end of the Thomson Lyra A/V Jukebox, and plug the other end into your computer's USB port. For details, go to page 11.



Car adapter kit and cassette adapter. For details, go to page 25.

Overview of buttons and jacks

The following pages explain what each button does — some of the buttons have more than one function depending upon whether or not you're playing music, videos, or viewing photos.

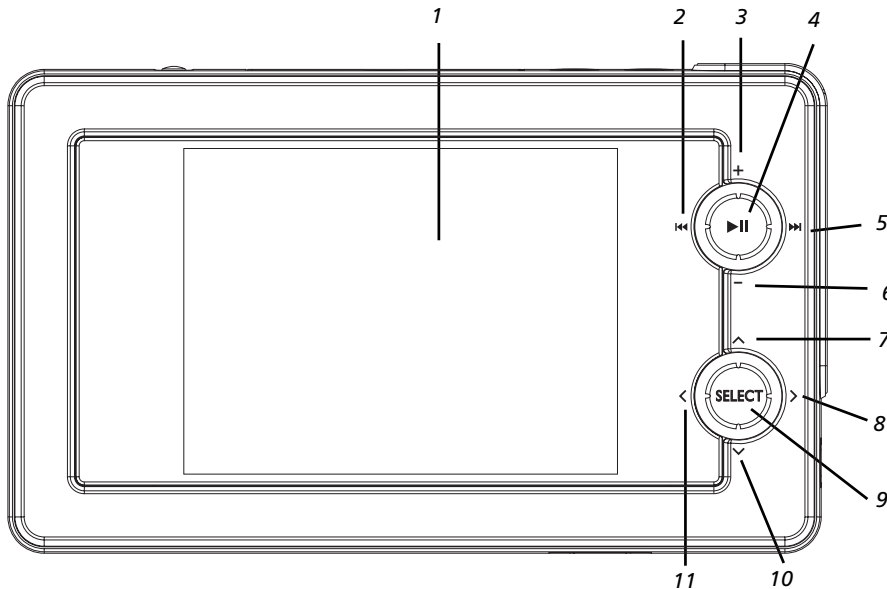

Front View

- 1 **LCD (Liquid Crystal Display)** – This is where the Thomson Lyra's user interface and multimedia content appear.
- 2 **Reverse button**– When you're playing a file, press and release to skip back to the previous file (to scan backwards in the audio or video file that's playing, press and hold).
- 3 **SmartTag button** – Allows you to tag the file to be included in Favorites or Program Play, depending on which mode you are in. (Feature currently not available. Visit <http://www.thomson-lyra.com> for the latest software and updates).
- 4 **Play/Pause** – Press to play. During playback, press to pause.
- 5 **Forward button** – When you're playing a file, press and release to skip forward to the next file (to scan forward in the audio or video file that's playing, press and hold).
- 6 **SmartUntag button** – Allows you to remove the tags from Favorites or Program Play, depending on which mode you are in. (Feature currently not available. Visit <http://www.thomson-lyra.com> for the latest software and updates).
- 7 **Up arrow button** – Moves highlight up.
- 8 **Right arrow button** – If you're viewing a folder or playlist, moves highlight forward one level and expands the item's contents.
- 9 **SELECT**– When using the Thomson Lyra AV Jukebox menu, selects a highlighted item. If file highlighted, displays the options menu.
- 10 **Down arrow button** – Moves highlight down.
- 11 **Left arrow button** – If you're viewing a folder or playlist, moves highlight back one level and collapses the item.

Top View

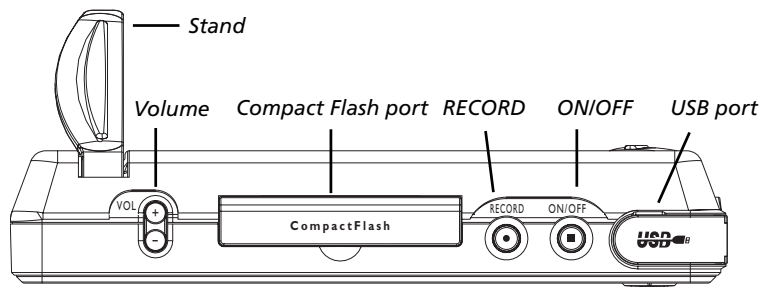

Stand– Pull the stand out to place the Thomson Lyra AV Jukebox upright on a surface.

VOL (Volume up and down) - Press VOL+ to increase the volume level; press VOL- to decrease the volume level.

CompactFlash port – Insert a CompactFlash memory card to copy files to your Thomson Lyra AV Jukebox. When connected to a computer, the CompactFlash card port functions as a high-speed card reader.

RECORD – Displays Recording Mode options menu.

ON/OFF button and Stop icon – Turns on your Thomson Lyra AV Jukebox. To turn off the Thomson Lyra AV Jukebox, press and hold. When you're playing files, stops playback.

USB port – Attach the small end (Type mini-B) of the mini-USB cable here. Attach the large end (Type A) to your computer.

Right Side View

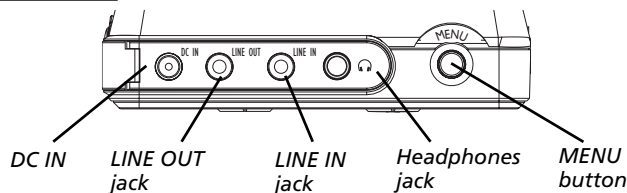

DC IN jack – Plug in the AC power adapter here. When you plug in the AC adapter, the battery inside of the Thomson Lyra AV Jukebox automatically starts charging.

LINE OUT jack – Attach the line out cable here when you're connecting the Thomson Lyra AV Jukebox to an audio/video component, such as a stereo receiver or TV.

LINE IN jack – Attach the line in cable here when you're connecting the Thomson Lyra AV Jukebox to an audio/video component, such as a TV, VCR, or camcorder.

Headphones jack – Insert the supplied ear buds to hear sound.

MENU button – When you're in the menu system, a momentary press brings navigation up one level; press and hold to return to Main Menu.

Bottom View

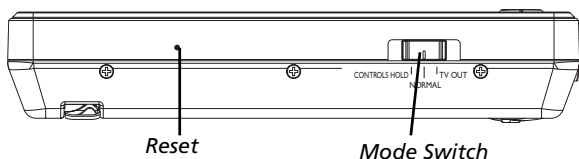

RESET button – If your Thomson Lyra AV Jukebox appears to be locked up, press the RESET button (the memory will be cleared and settings will return to the factory defaults).

CONTROLS HOLD – To make the buttons inactive, slide the switch to the CONTROLS HOLD (button lock on) position (the  icon appears in the display to remind you that you've locked the buttons). Slide the switch to the NORMAL position for normal operation (button lock off).

NORMAL – To listen to music, view photos, or watch video, slide the switch to Normal mode.

TV OUT – If you've connected a cable to the LINE OUT jack, slide the switch to TV OUT to display the Thomson Lyra's user interface and multimedia content on the connected video component.

Getting Started: Software Setup

Setup Information

Install software in your computer (Windows support only)

The Music Management CD that came with your Thomson Lyra AV Jukebox contains all of the necessary software components you need to make your Thomson Lyra AV Jukebox work properly. These components do the following:

- view the User's Guide and documentation for the Thomson Lyra AV Jukebox
- install USB driver for Windows 98SE/Me users (Refer to page 9)
- enable you to transfer files from your computer to your Thomson Lyra AV Jukebox
- install Thomson Lyra AV Jukebox system application to profile, sort the contents, update the system files, verify user playlists, and use LyraSync functionality to sync files/folders between your computer and device (refer to page 13)
- use the MusicMatch Jukebox™ software to organize your music collection and transfer the music to your Thomson Lyra AV Jukebox

The MusicMatch Jukebox software compresses audio files (from music CDs) to the mp3 or mp3PRO format so you can play them on your Thomson Lyra AV Jukebox. The MusicMatch software also enables you to download files from the internet that are already compressed and then transfer those files to your Thomson Lyra AV Jukebox (or play the music on your computer).

Note: For Mac users, drag and drop file support is currently available. No software components are provided at this time.

Insert the Included CD-ROM into CD-ROM Drive

Note: Don't connect your Thomson Lyra AV Jukebox to your computer before you have installed the required drivers (Windows 98SE/Me only).

1. Turn on your computer and place the Music Management CD that came with your Thomson Lyra AV Jukebox into your computer.

IMPORTANT: Don't connect the USB cable to the PC or Thomson Lyra AV Jukebox before or during the driver installation.

If you're running Windows 2000 or XP, no additional drivers are required. If you're running Windows 98SE or Me, you **must** install the device drivers from the CD-ROM in order for the Thomson Lyra AV Jukebox to function properly.

Note: Windows 2000 users must have Service Pack 3 or later installed in order for proper device operation.

2. If the setup screen does not appear, double click *My Computer*, double click your CD-ROM drive icon, and double click *Install* to run the installer.



3. Select your Thomson Lyra model (PDP2860 (Thomson Lyra AV Jukebox Player)) on the setup screen and click *Install* to access installation programs corresponding to your Thomson Lyra device.



4. Click the software components you're going to install (a list follows):
 - Universal Serial Bus Drivers (Windows 98SE/Me only)
 - Lyra AV Jukebox system application
 - MusicMatch Jukebox
 - MusicMatch Jukebox device plug-in
 - Additional services (*Install ID3man by Auditude, Get 100 Free mp3 Tracks from eMusic, Install Moodlogic Mix & Transfer, or Try RHAPSODY Music Service*)

MusicMatch and MusicMatch Jukebox are registered trademarks of MusicMatch Corp.

5. Follow the on-screen instructions to install all necessary files, or for detailed instructions for loading each component, see the following pages.
6. Click *Finish* to complete installation of the selected component and return to the start-up screen.
7. Click *Quit* to exit the setup application.

Install the USB Driver and System Applications (Windows 98SE and Me only)

For Windows 98SE and Me systems, you need to install a USB driver before your computer can recognize your Thomson Lyra AV Jukebox, as well as the available System Applications component.



1. Click *Install USB Driver/System Applications* to install the required driver and system application for your Thomson Lyra AV Jukebox.
2. Follow the on-screen instructions to install all necessary files.
3. Click *Finish* to complete installation and return to the start-up screen.

Note: A restart of your system may be required after installation is completed.

Install System Applications (Windows 2000 or XP)



1. Click *Install System Applications* to install system applications that will help you better manage your Thomson Lyra AV Jukebox.
2. Follow the on-screen instructions to install all necessary files.
3. Click *Finish* to complete installation and return to the start-up screen.

(Refer to page 13 for further system application details).

Install MusicMatch Jukebox

MusicMatch Jukebox is a music management software used to organize and manage digital audio files and transfer music to your Thomson Lyra AV Jukebox. Make sure you have installed the USB Driver/System Applications (Windows 98SE/Me) or System Applications (Windows 2000/XP) before you install MusicMatch Jukebox.



1. Click *Install MusicMatch Jukebox* to run the MusicMatch setup program.

Wait while the installation program begins. It may take up to 20 seconds for the installer to start.

Note: It is recommended to uninstall any previous installations of the MusicMatch Jukebox software before proceeding. After the uninstall process has been completed, delete the C:\Program Files\MusicMatch folder from Windows and where C:\Program Files is the path where the software was installed. If you do not wish to uninstall the previous MusicMatch Jukebox software, go to "Install MusicMatch Plug-in" on page 11.

2. The *Welcome* screen appears, click *Next* to continue and show License Agreement.

Getting Started: Software Setup



3. After you've read the license agreement, click *Yes* to accept (to continue, you must click *Yes*), or *No* to decline. If you click *Yes*, the *User Registration Information* screen appears.



4. Enter your year of birth, name, e-mail address, country, postal code, and gender. Click *Next* to continue.

Note: You must enter an e-mail address to proceed. If you don't have an e-mail address, enter *yourname@home.com*

5. The *Personalize Music Recommendation* screen appears. Read the screen to determine if you want to use this feature or not — you can always change the setting later. Select *Yes* or *No* and click *Next* to continue.

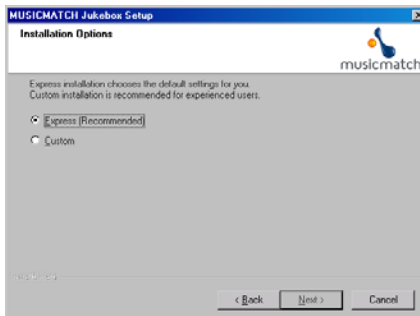

6. The *Installation Options* dialog screen appears. Select *Express* and click *Next* to continue (the installation starts).



7. After the installation is complete, click *Finish*.

8. If necessary, close the main setup screen.

9. Some computers might request that you reboot your computer (a dialog box will appear on the computer screen if this is necessary).

Note: As with any device that has a hard drive, you must back up the drive. Thomson is not responsible for lost data.



For more information on MusicMatch Jukebox, click *Tutorials* on the CD or go to www.musicmatch.com.

Install MusicMatch Plug-In

MusicMatch requires a plug-in for your particular device in order to download audio files using MusicMatch Jukebox and transfer the files from your computer to your Thomson Lyra AV Jukebox.



1. Click *Install MusicMatch Plug-In*.
2. Follow the on-screen instructions to install all necessary files.
3. Click *Finish* to complete installation and return to the start-up screen. After plug-in has been installed, launch the MusicMatch Jukebox software.

Note: If the MusicMatch Jukebox Software is already running, you may need to restart it in order for newly installed Thomson Lyra plug-in to be properly recognized.

Software Information

Launch the MusicMatch software

After you've installed the necessary components, you're ready to begin converting and transferring audio files. The MusicMatch software converts audio files to the mp3 and mp3PRO format so you can play them on your Thomson Lyra AV Jukebox.

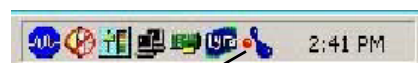

MusicMatch icon

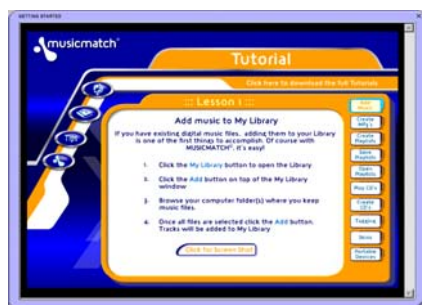

1. Remove the Music Management CD from your computer.
2. Start the MusicMatch Jukebox software (click on the MusicMatch icon in your system tray or on your desktop).
3. The first time you launch MusicMatch, a *Getting Started* screen appears providing information about MusicMatch and the software.
4. Detailed information, Getting Started tips, and troubleshooting are available through the Help menu and the MusicMatch internet site (accessed from the Help and Site menus). We recommend you familiarize yourself with the MusicMatch Welcome Tips and view the On-line FAQs before using and recording files.

Note: Logging onto the internet while using MusicMatch Jukebox takes advantage of all its features.

Click on *Install ID3man Auditude*, *Get 100 Free mp3 Tracks from eMusic*, *Install Moodlogic Mix and Transfer*, or *Try RHAPSODY Music Service* for additional digital music services provided by Thomson.

Connecting Thomson Lyra AV Jukebox to the Computer

Connect the Thomson Lyra AV Jukebox to your computer with the mini USB cable provided. Turn on the unit by pressing the ON/OFF button. The Thomson Lyra AV Jukebox will appear as a Removable Disk drive letter.

If a CompactFlash memory card is properly inserted, an additional drive letter may be accessed as a Removable Disk drive letter through Windows Explorer as well. The Thomson Lyra AV Jukebox functions as a high-speed CompactFlash card reader as well.

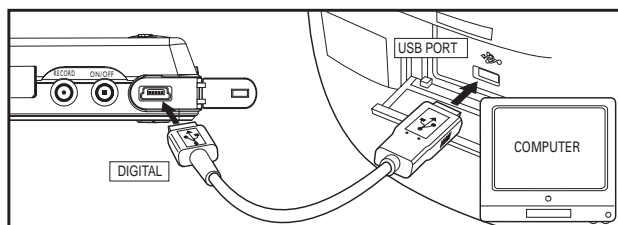

Notes: It might take several seconds for the device (the Thomson Lyra AV Jukebox) to be detected, especially in Windows 2000/XP. Click *Refresh* in *My Computer* or *Explorer* to make sure the device has been detected.

The Thomson Lyra AV Jukebox is capable of transferring files at high-speed mode of USB 2.0. This is up to 40 times faster than USB 1.1. If USB 2.0 port is available on your computer, use it to connect to your Thomson Lyra AV Jukebox. The Thomson Lyra AV Jukebox is still backward compatible with the older USB 1.1 ports. However, you won't be able to take full advantage of the potential speed increase.

Getting Started: Software Setup

Transferring Files to Thomson Lyra AV Jukebox

You can transfer files to your Thomson Lyra AV Jukebox via MusicMatch Jukebox or Windows Explorer.

Connect your Thomson Lyra AV Jukebox if isn't already connected to your computer using the provided USB cable as previously illustrated.

Note: Don't disconnect the USB cable during music download. Doing so may corrupt system files or the files being downloaded. It is highly recommended that the Thomson Lyra AV Jukebox be connected to the ROOT USB PORT (the main USB port) on the PC or a self powered USB hub.

Transfer Files Via MusicMatch Jukebox

1. Start the MusicMatch Jukebox software. Drag and drop the desired tracks from the *Music Library* to the *Playlist* display.



2. From the menu area, select *Files/Send to Portable Device* to display the *Portable Device Manager* screen. Under the *Attached Portable Devices* option, select *Lyra Personal Audio Player*.

Note: If more than one Thomson Lyra AV Jukebox is connected to your computer, select the corresponding **Lyra Personal Audio Player** displayed in the drive you want to transfer content to.

3. Select the playlist item and drag it to the *Lyra Personal Audio Player*. The songs in the playlist are transferred to your Thomson Lyra AV Jukebox.

Note: If your Thomson Lyra AV Jukebox doesn't appear in the *Portable Device Manager* area, click the **REFRESH** button.

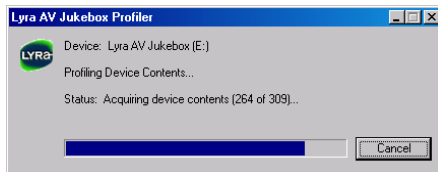

When the transfer is finished, the Thomson Lyra AV Jukebox Profiler application automatically runs so it can sort/profile the newly transferred audio files.

Caution: Make sure all data are transferred to the Thomson Lyra AV Jukebox before unplugging the USB cable.

In Windows 2000/XP, you must stop the device before unplugging it. Click the  icon (the *Unplug or Eject hardware* icon) from the system tray and select the *USB Mass Storage device* for the drive associated with the Thomson Lyra AV Jukebox, and click **STOP**. See the *Windows Help* for details about the *Unplug or Eject Hardware* topic.

In Windows 98SE/ME, click the  icon and follow the same instructions as above.

Transfer Files Via Windows Explorer (Drag and Drop)

If your Thomson Lyra AV Jukebox isn't already connected to your computer, connect it using the provided USB cable.

Thomson Lyra AV Jukebox hard drive AUDIO, VIDEO, and PHOTOS folders

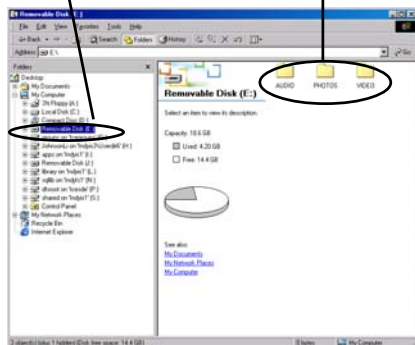

From Windows Explorer, open the Thomson Lyra AV Jukebox drive. Open the drive where the files/folders you want to transfer are located, and highlight them. Drag the files/folders to the associated folder on the Thomson Lyra AV Jukebox drive.

Supported multimedia files should be stored in the following folder structure off of the root of the hard drive to ensure the files will be properly recognized by the device:

Audio Content-it is highly recommended that all supported audio files (mp3 or mp3PRO) be stored in the *AUDIO* system folder to allow for easy navigation and organization of the contents of the Thomson Lyra AV Jukebox.

Photo Content- supported photo files (JPEG or JPG) must be stored in the *PHOTOS* system folder in order to be available for viewing on the device. Sub-folders may be created under the *PHOTOS* system folder for easy navigation and organization of your image files.

Video Content- supported video files (MPEG4 in avi file format) must be stored in the *VIDEO* system folder in order to be available for playback on the device. Sub-folders may be created under the *VIDEO* system folder for easy navigation and organization of your video content.

Note: If a CompactFlash memory card is properly inserted, an additional drive is available through Windows Explorer to transfer content onto. Please ensure the correct drive is being used when transferring content from the device.

CompactFlash Content- When a CompactFlash memory card is properly inserted into the device, the contents will appear in FILES system folder. Only Photo content will be available for direct playback (viewing) on the Thomson Lyra AV Jukebox. Audio and Video content must be copied onto the device's hard drive in order to be available for playback. Audio and Video content on the CompactFlash memory card may also be copied to a computer for playback.

When all files have been transferred to the Thomson Lyra AV Jukebox hard drive, you must re-profile the audio contents by using the Lyra System Tray Application to ensure all audio content is properly sorted and recognized on the Thomson Lyra AV Jukebox. See next section for more details on the System Tray Application.

Thomson Lyra Jukebox System Applications

Profile Device Contents (Audio only)

New audio files that are transferred to your Thomson Lyra AV Jukebox using Windows Explorer (drag and drop) will not appear in the Audio Navigation Menus until you profile the contents. If MusicMatch Jukebox was used to transfer files, you don't need to profile content as profiling is done automatically.

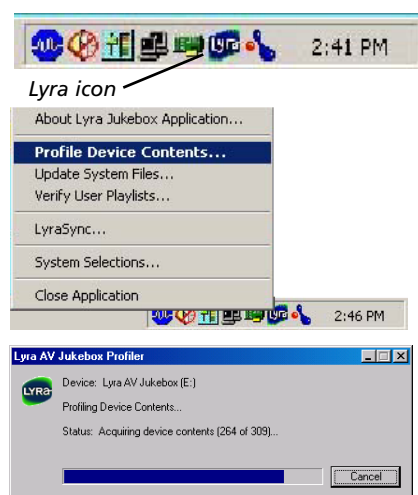

1. Connect your Thomson Lyra AV Jukebox to the computer using the provided USB cable if it is not already connected.
2. After all audio files have been transferred to the device, right click on the Lyra icon  in the System tray (bottom right hand corner of the computer screen).
3. Select the *Profile Device Contents...* option to start profiling and sorting contents.
4. Click *Done* when profiling is complete.

Note: If more than one Thomson Lyra AV Jukebox is connected to your computer, you will be prompted to select the corresponding drive you want to profile.

Note: Video and Photos content will appear in the Navigation menus based on the folder/file structures in the VIDEO and PHOTOS system folder. Profiling of Video and Photos content is not necessary.

Updating System File

You can upgrade your Thomson Lyra AV Jukebox or repair system files on your device if it becomes damaged by downloading the latest firmware from <http://www.thomson-lyra.com>. After you have downloaded the latest firmware, follow the steps below to update your system files.

1. Connect your Thomson Lyra AV Jukebox to the computer using the provided USB cable if it is not already connected.



2. Right click on the Lyra icon  in the System tray (bottom right hand corner of the computer screen) and select the *Update System Files...* option to start updating your system with the latest firmware.

Note: If more than one Thomson Lyra AV Jukebox is connected to your computer, you will be prompted to select the corresponding drive you want to update.

Possible cause of system file damage:

- System files and/or folders were accidentally deleted from the device
- You have formatted your Jukebox.

Getting Started: Software Setup

Verify User Playlists

Verify User Playlists stores items under the *playlist* system folders (AUDIO, VIDEO, PHOTOS) on the Thomson Lyra AV Jukebox. Audio playlists must be in the M3U file format under the AUDIO system folder. Video playlists must be in the V3U file format under the VIDEO system folder. Photos playlists must be in the J3U file format under the PHOTOS system folder. See the Thomson Lyra AV Jukebox readme file for more information.

Note: Playlist files can be stored in sub-folders under the AUDIO, VIDEO, PHOTOS system folders as well for easier navigation and storage of your multimedia content.

1. Connect your Thomson Lyra AV Jukebox to the computer using the provided USB cable if it is not already connected.



2. Right click on the Lyra icon  in the System tray (bottom right hand corner of the computer screen) and select the *Verify User Playlists...* option.

Note: If more than one Thomson Lyra AV Jukebox is connected to your computer, you will be prompted to select the corresponding drive you want to verify user playlists.

LyraSync

Files and folders can be synchronized between your PC and your Thomson Lyra AV Jukebox.

1. Connect your Thomson Lyra AV Jukebox to the computer using the provided USB cable if it is not already connected.

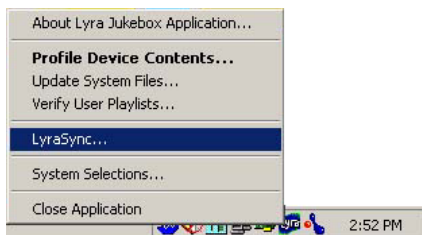

2. Right click on the Lyra icon  in the System tray (bottom right hand corner of the computer screen) and select *LyraSync*.

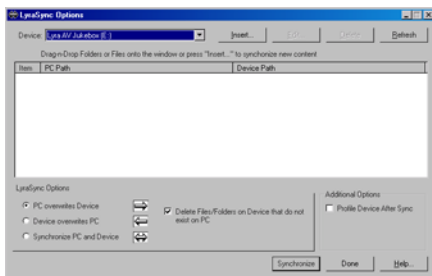

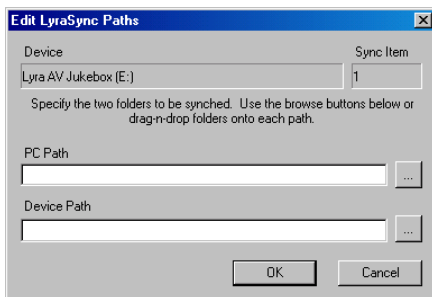

3. The *LyraSync Options* screen appears.





4. Click *Insert* to select the paths of files and folders to synchronize between your PC and the Device. Click *OK*.
5. Select the desired LyraSync direction.
 - PC overwrites Device
 - Device overwrites PC
 - Synchronize PC and Device
6. Click *Synchronize* to start.

Disconnecting Your Thomson Lyra from the Computer

Windows Users

Before disconnecting your device, to ensure there is no loss of data, from the System Tray, left click on the  icon (or the  icon in Windows 98SE/Me) and select *Unplug or Eject Hardware* (the *Unplug or Eject Hardware* screen appears). Select the drive(s) corresponding to your Thomson Lyra player and click Stop.

The *Stop a Hardware Device* screen appears. Select the device to be stopped again for confirmation and click OK. You can also stop your Thomson Lyra AV Jukebox by right clicking on the  icon (or the  icon in Windows 98SE/Me) from the system tray and selecting the drive(s) corresponding to your player.

Mac Users

From the Desktop, drag the mounted volume icon(s) associated with the Thomson Lyra AV Jukebox into the trash folder.

Note: *If CompactFlash is connected, two volumes will be available on the desktop.*

You can also select the Eject option for the mounted volume(s) associated with the device to ensure the device is properly put away before being disconnected.

Chapter 2: Using the Setup Menu

Setup Menu

The Setup Menu allows you to make changes to the Audio, Video, and Photo settings, as well as make changes to main functions of the Thomson Lyra AV Jukebox.

From the Main menu, press the up or down arrow to highlight *Setup*. Press SELECT to view the Setup menu. The following options appear:



Audio/Video Settings Press the right arrow to view the Audio/Video settings. Options within the Audio/Video settings are explained later in the section under Audio/Video Settings Menu.

Photos Settings Press the right arrow to view the Photos settings. Options within the Photos settings are explained later in the section under Photos Settings Menu.

LCD Brightness Press the right or left arrow to increase or decrease the brightness to the LCD screen.

Video Record Quality Press the right arrow to select a video recording quality- *LP-Low* (long play), *SP-Med* (standard play), *HQ-High* (high quality).

Audio Record Quality Press the right arrow to select an audio record quality- *96 k-Low* (low quality), *128 k-Med* (medium quality), *192 k-High* (high quality).

Power Save Timer Press the right arrow to set a time for Power Save- *OFF*, *60 sec* up to *120 sec* (10 second increments).

Backlight Timer Press the right arrow to set a time for the backlight to the LCD screen to turn off- *OFF*, *5 sec* up to *120 sec* (5 second increments).

Password Protection Allows you to lock the device by entering a password. (Feature currently not available. Visit <http://www.thomson-lyra.com> for the latest software and updates).

Sleep Timer Press the right arrow to set a one-time timer for the unit to shut down after playback has been activated- *OFF*, *30 min*, *60min*, *90min*, and *120min*.



Date & Time Press the right arrow (the *Date & Time Settings* screen appears with *Date* highlighted). Press the right arrow to highlight the month setting. Press the up or down arrow to select the current month. Press the right arrow to highlight the day. Press the up or down arrow to select the current day. Follow the same procedure to set the year.

Press the right arrow when you're finished setting the date to highlight the Date and Time options again. Press the down arrow to highlight *Time*. Follow the same directions for setting the date to set the time.

Lyra Info Press the right arrow to display information about your Lyra- *Hard Drive Capacity*, *Available Hard Drive Space*, *Total Files*, and *Software Version*.

TV Standard Press the right arrow to change the TV Standard: *NTSC* (National Television Standards Committee) is the North American television standard, or *PAL* (Phase Alternation by Line) is used in some European countries and elsewhere.





Audio/Video Settings Menu

Status Display (video only) Press the right arrow to turn on or off the information, such as time elapsed, that appears on screen during video playback.

Bookmark Allows you to set video bookmarks during playback. (Feature currently not available. Visit <http://www.thomson-lyra.com> for the latest software and updates).

Audio Playback Press the right arrow to select one of the playback options: **NORMAL**- songs from the sorting category selected are played in the order they appear, **REPEAT**- repeats songs from the sorting category selected and are played in the order they appear, **REPEAT 1**- repeats current song being played, **REPEAT ALL**- repeats all songs in the Audio Navigation mode based on their order in the current sorting mode (Audio, Album, etc.), **SHUFFLE**- songs/sub-categories from the current sorting category are played in random order, **SHUFFLE ALL**- all songs from the sorting mode (Audio, Album, etc.) are played in random order, **SHUFFLE REP (Shuffle Repeat)**- songs/sub-categories from the current sorting category are repeatedly played in random order, **SHUFFLE ALL REP (Shuffle All Repeat)**- all songs from the sorting mode are repeatedly played in random order. You can change the playback option in the audio playback menu as well.

Video Repeat Press the right arrow to select one of the repeat options: **OFF**, **ON**- video files from a folder or sorting category are played repeatedly, **ONE**- video played is repeated, **ALL**- repeats all videos available in the Video navigation mode.

Brightness Allows you to increase or decrease the brightness of the video during playback. (Feature currently not available. Visit <http://www.thomson-lyra.com> for the latest software and updates).

Color Allows you to increase or decrease the color of the video during playback. (Feature currently not available. Visit <http://www.thomson-lyra.com> for the latest software and updates).

Contrast Allows you to increase or decrease the contrast of the video during playback. (Feature currently not available. Visit <http://www.thomson-lyra.com> for the latest software and updates).

Audio Equalizer Allows you to select a specific equalizer setting to adjust the various levels of the audio output for different types of audio content. (Feature currently not available. Visit <http://www.thomson-lyra.com> for the latest software and updates).

Audio Clips Allows you to sample audio content files without activating playback. (Feature currently not available. Visit <http://www.thomson-lyra.com> for the latest software and updates).

Video Clips Allows you to sample video content files without activating playback. (Feature currently not available. Visit <http://www.thomson-lyra.com> for the latest software and updates).

Tile Display Mode (for video only) Determines how the video contents are displayed during navigation mode. When Tile Display is off, files are displayed in button format, folders listed first in alphabetical order, video files follow in alphabetical order. Sub-folders or video files from a highlighted folder are displayed on the right side of the screen (sub-folders listed first in alphabetical order and video files follow in alphabetical order).

Note: *Tile Display Mode ON currently not available. Visit <http://www.thomson-lyra.com> for the latest software and updates.*



Tile Display Mode Off

RESET Select to reset Audio and Video settings to the factory defaults.



Photo Settings Menu

Status Display Displays information, such as file name, that appears on screen when viewing a photo. (Feature currently not available. Visit <http://www.thomson-lyra.com> for the latest software and updates).

Notes Display Notes associated with the photo are displayed while viewing a photo. (Feature currently not available. Visit <http://www.thomson-lyra.com> for the latest software and updates).

Slideshow Settings Press SELECT to view the Slideshow Settings options.

Press the up or down arrow to turn *OFF* or *ON* the Slideshow option.

Press the right arrow to highlight the *Interval* option. This is the amount of time each photo is shown during the slideshow. Press the up or down arrow to change the amount of time starting at 2 seconds, up to 60 seconds.

When you've finished setting the *Interval* option, press the right arrow to highlight the *Mode* option. Press the up or down arrow to select *Normal*- plays all files in the current folder, *ALL*- plays all photo files in the current folder as well as any sub-folders in the current folder, *Repeat*- repeats all photo files in the current folder, *Rep-All* (Repeat All)- repeats all photo files in the current folder as well as any sub-folders in the current folder.

Play Audio File A slideshow must be set in order to choose an audio file. Highlight *Play Audio File* to browse for an audio file to be played during a slideshow. Once a file is selected, the Audio Browse mode is exited and the file name is displayed next to the *Play Audio File* option.

Note: You can only browse for audio files during *Play Audio File*; you can't listen to the audio files.

Rotate Photo Allows you to select a rotate a photo. (Feature currently not available. Visit <http://www.thomson-lyra.com> for the latest software and updates).

Brightness Allows you to increase or decrease the brightness to photo content during playback. (Feature currently not available. Visit <http://www.thomson-lyra.com> for the latest software and updates).

Color Allows you to increase or decrease the color to photo content during playback. (Feature currently not available. Visit <http://www.thomson-lyra.com> for the latest software and updates).

Contrast Allows you to increase or decrease the contrast to photo content during playback. (Feature currently not available. Visit <http://www.thomson-lyra.com> for the latest software and updates).

Tile Display Mode Determines how the photo content is displayed during navigation mode. When *Tile Display* is off, files are displayed in button format, folders listed first in alphabetical order, photo files follow in alphabetical order. Sub-folders or photo files from a highlighted folder are displayed on the right side of the screen (sub-folders listed first in alphabetical order and photo files follow in alphabetical order).

Note: *Tile Display Mode ON* currently not available. Visit <http://www.thomson-lyra.com> for the latest software and updates.



Tile Display Mode Off

RESET Select to reset Photo settings to the factory defaults.

Basic Information

The Thomson Lyra AV Jukebox is able to play video and music, view pictures, and also store any computer files. The 20 GB hard drive storage allows you to:

- Record and view up to approximately 80 hours of video
- Record and play up to approximately 300 hours of music (record quality at 128kpbs)
- Store and view up to approximately 100,000 JPEG images

Note: Audio only mp3 encoded at 128kpbs; Video (with audio) encoded at 480kpbs; JPEG images assume average of 150KB per file. Actual recording time and available storage space vary depending on system requirements, bitrate and other factors.

You can find out how much availability is on your hard drive by going to the *Setup* menu and selecting *Lyra info* (go to page 16 for more information).

Note: The built-in battery needs to be charged 4 hours by the supplied AC/DC adapter before it is fully charged .

Basic Screen Information

While viewing the Video, Audio, Photos, or Files menu, the same type of information appears on-screen.



- 1 Displays the file or folder name highlighted in the menu system.
- 2 Displays the mode you are in- *Video*, *Audio*, *Photos*, or *Files*, along with the mode icon
- 3 The Lock icon is displayed if the CONTROLS HOLD on the bottom of the unit is switched on.
- 4 The Battery icon displays how much power remains on the battery (full green bar indicates 75%-100%, is 50%-75%, 25%-50%, red bar indicates below 25%, indicates battery is dead.
- 5 The preview window displays the picture associated with the mode, or if available, the file highlighted.

Basic Operation

The information in this section presumes you've successfully transferred files to your Thomson Lyra AV Jukebox, and you're ready to play different types of files.

If you need specific setup information (downloading music, transferring files, installing software), go to Chapter 1.

If you want more detailed information about the Thomson Lyra AV Jukebox's menu system, go to page Chapter 2.

Understanding how to navigate through the Thomson Lyra AV Jukebox's menu system, as well as how the buttons operate, will give you the information you need for basic functionality.

The main menu displays *Video*, *Audio*, *Photos*, *Files* and *Setup* on the left side of the LCD screen. The navigation scheme is the same no matter what menu you access:

1. Press the arrow up or down buttons to highlight different items on the screen.
2. Press the right arrow button to open a folder or sorting category to display the item's (Video, Audio, etc.) contents.

Playing Files

3. Press the left arrow button to close a folder or sorting category and move back one level.
4. Press the up or down arrow button to highlight a file, then press SELECT to display the Options menu, or press ▷|| (play/pause) to start playback. Press play/pause again to pause playback. If a folder is highlighted, press SELECT to open the folder and display its contents.

Playing Video

To select and play a video from the Main Menu:

1. Press the up or down arrow to highlight *Video* and press SELECT. Video content appears on the left side of the screen in the same folder or file structure as it's stored on the hard drive.



2. Press the down arrow button to highlight the video or video folder you want to select, for example, *Spring Vaca...* (*Spring Vacation*). The following appears:



- A list of videos and sub-folders appear on the left side of the screen. Press the right arrow to display the files under *Spring Vaca...* (*Spring Vacation*). The videos appear on the right side of the screen. This type of navigation is with Tile Display Mode turned off.

3. Continue to press the up or down arrow to highlight a sub-folder, or video file. Press the left or right arrow to move back or forward a level.

Once you have highlighted a video you want to view, press SELECT to display the Options Menu (or press Play/Pause to start playback for the selected video and the Options menu won't appear). The Video Options Menu description follows:



Highlight *Play* and press SELECT to play the video.

Highlight *Exit* and press SELECT to return to the last viewed Video menu.

Highlight *Add to Favorites* to add the video to your favorites list in the Video system folder. (Feature currently not available. Visit <http://www.thomson-lyra.com> for the latest software and updates).

Highlight *Add to User Playlist* to add the video to your playlist file in the Video system folder. (Feature currently not available. Visit <http://www.thomson-lyra.com> for the latest software and updates).

Highlight *Program Play* to start program playback. (Feature currently not available. Visit <http://www.thomson-lyra.com> for the latest software and updates).

Highlight *Move To* and press SELECT if you want to move the video to a different folder.

Highlight *Delete* and press SELECT to delete the video from the folder.

Highlight *Create Folder* to make a new folder. (Feature currently not available. Visit <http://www.thomson-lyra.com> for the latest software and updates).

Recording Video to Your Thomson Lyra AV Jukebox

From an Audio/Video Component

You can record video from video components that have video output jacks, such as a TV, VCR, cable or satellite box, using the supplied Line In cable.

Note: You might want to change the Video Record Quality setting in the Setup menu (go to Chapter 2) if you want to record at a lower quality to take up less space, or to record at a higher quality for better video. The default record quality is SP-Med (standard play). A 30 minute program recorded at this quality will take up approximately 220-270 MBytes.

To view recorded content on your TV, it is recommended to set the Video Record Quality to HQ- High (high quality).

To view recorded content on your Thomson Lyra AV Jukebox, it is recommended to set the Video Record Quality to SP-Med (standard play).

1. Make sure your Thomson Lyra AV Jukebox is off.
2. Connect the 2.5mm mini-plug end of the cable to the LINE IN jack on your Thomson Lyra AV Jukebox player.
3. Connect the yellow (video) to the Video Output jack to the component. If you want to record sound, connect the red (audio right) and white (audio left) cables to the corresponding right and left Audio Output jacks on your component.
4. Turn on the power to your component, and select the input you're recording from (for example, if you want to record a tape playing from the VCR to the TV, you need to switch to VCR mode on the TV to view the tape).
5. Turn on your Thomson Lyra AV Jukebox.
6. Highlight and select *Video*.
7. Press the RECORD button on the top of the Thomson Lyra AV Jukebox when are you ready to record (the Recording Mode screen appears). If you need to, press PLAY on the device connected to the TV (for example, a VCR).
8. Press SELECT to begin recording, or highlight one of the pre-set times to record so you don't have to press Stop. Once recording begins, the record screen appears with status, Recording time (if *Start Recording* was selected, this will be blank) elapsed time, recording quality and the file name shown.
9. When finished recording, go to the Video system folder to find the newly created file (the file name shown during recording).

Playing Files

From Computer

You can record video from your computer using a Line Out to mini-Line In cable if your computer has a Line Out jack.

1. Make sure your Thomson Lyra AV Jukebox is off.
2. Connect the smaller end of the cable (mini-Line In) to the LINE IN jack on your Thomson Lyra AV Jukebox player.
3. Connect the other end to the Line Out jack on your computer.
4. Turn on the power to your computer, and select the file you want to record from.

Follow steps 5-9 of *From an Audio/Video Component*.

Downloading Video to Your Thomson Lyra AV Jukebox

You can download video content from your computer using the supplied USB cable if your computer has a USB port. You can also insert a CompactFlash memory card to the CompactFlash port and use the supplied USB cable to download video content to your CompactFlash memory card. Go to page 13 for more information.

Viewing Video Content on Your TV

You can view video content stored on the hard drive of your Thomson Lyra AV Jukebox using the supplied Line Out cable if your TV has Audio and Video Input jacks.

1. Make sure your Thomson Lyra AV Jukebox is off.
2. Connect the 2.5mm mini-plug end of the cable to the LINE OUT jack on your Thomson Lyra AV Jukebox player.
3. Connect the yellow (video) to the Video Input jack. Connect the red (audio right) and white (audio left) cables to the corresponding right and left Audio Input jacks on your TV.
4. Turn on the power to your TV, and change to the corresponding input channel on your TV.
5. Turn on your Thomson Lyra AV Jukebox. Switch the Mode Switch to TV OUT.
6. Highlight and select *Video*.
7. Find the file you want to view on the TV. Press the Play button.

Playing Audio

To select and play a song from the Main Menu:

1. Press the up or down arrow to highlight *Audio* and press SELECT to enter the Audio navigation mode. Eight sorting categories are displayed, including six sort options.



2. Press the down arrow button to highlight the sorting category you want to select a song from, for example, *Artist*.
3. Press the right arrow to display the list of Artists (the Artists appear on the right side of the screen).
4. Continue to press the up or down arrow to select the album, and song. Press the left or right arrow to move back or forward a level in the sorting category (*Artist, Album, Title, etc...*).

Press SELECT at any sorting level to display the Options Menu (or press Play/Pause to start playback for the selected category, or song and the Options menu won't appear). The Audio Options Menu description follows:



Highlight *Play* and press SELECT to play the current song or category selected.

Highlight *Exit* and press SELECT to return to the last viewed Audio menu.

Highlight *Add to Favorites* to add the song or album to your favorites list in the Audio system folder. (Feature currently not available. Visit <http://www.thomson-lyra.com> for the latest software and updates).

Highlight *Add to User Playlist* to add the song or album to a playlist file in the Audio system folder. (Feature currently not available. Visit <http://www.thomson-lyra.com> for the latest software and updates).

Highlight *Program Play* to start program play. (Feature currently not available. Visit <http://www.thomson-lyra.com> for the latest software and updates).

Audio Playback Screen

The following screen is an example of what an audio playback screen might look like.



Artist, Album, Song, Title, Genre, Track and Yr (Year)- Displays the ID3 tag information contained in the file, if available. If no ID3 tag information is available, the field will display *Unknown*.

- 1 **Encoded Bit-rate** – Indicates the bit-rate the audio file was encoded in when created.
- 2 **Elapsed time**– When you're playing music, the amount of time that the track has played appears.
- 3 **Lock icon**- Displayed when CONTROLS HOLD on the bottom of the unit is switched on (button lock on).
- 4 **Battery Indicator**- Indicates how much power remains on the battery. Go to page 19 for more information on battery indicator levels.
- 5 **Playback Mode**- During playback, the play icon arrow is highlighted (as in graphic above). When you pause playback, the pause (||) icon is highlighted. During forward or reverse playback, the >> or << icons are highlighted.
- 6 **Audio Equalizer Preset setting (Rock)** – For more information about Audio Equalizer Preset settings, go to page 17. (Feature currently not available. Visit <http://www.thomson-lyra.com> for the latest software and updates).
- 7 **Volume level indicator** – There are 33 steps in the volume control. Press the volume up/down buttons to increase or decrease the volume. The volume level bar is displayed on screen when increasing or decreasing the volume.
- 8 **Mode (Shuffle All)** – Displays current playback mode (Normal, Repeat, Shuffle, etc.). For more information about playback mode settings, go to page 17. Highlight the tab and press the up or down arrow to change the mode setting.

Recording Audio to Your Thomson Lyra AV Jukebox

From Stereo System

You can record audio from an audio/video component, such as a stereo system, using the supplied Line In cable if the component has Audio Output jacks.

Note: You might want to change the Audio Record Quality setting in the Setup menu (go to Chapter 2) if you want to record at a lower quality to take up less space, or to record at a higher quality for better sound. The default record quality is 128 k (medium quality- mp3 audio).

1. Make sure your Thomson Lyra AV Jukebox is off.
2. Connect the 2.5mm mini-plug end of the cable to the LINE IN jack on your Thomson Lyra AV Jukebox player.
3. Connect the red (audio right) and white (audio left) cables to the corresponding right and left audio jacks on your stereo system.
4. Turn on the power to your audio system, and select the mode you're recording from (for example, if you want to record a CD, make sure the stereo is in CD mode).
5. Turn on your Thomson Lyra AV Jukebox.
6. Highlight and select *Audio*.
7. Press the RECORD button on the top of the Thomson Lyra AV Jukebox when you're ready to record (the Recording Mode screen appears). If you need to, press PLAY on your stereo.
8. Press SELECT to begin recording, or highlight one of the pre-set times to record so you don't have to press Stop. Once recording begins, the record screen appears with status, Recording time (if *Start Recording* was selected, this will be blank) elapsed time, recording quality and the file name shown.
9. When finished recording go to the Audio system folder to find the file (the file name shown during recording).

If your stereo doesn't have Audio Out jacks, you can record from the headphone jack using a headphone to mini-Line In cable.

1. Make sure your Thomson Lyra AV Jukebox is off.
2. Connect the smaller end of the cable (mini-Line In) to the LINE IN jack on your Thomson Lyra AV Jukebox.
3. Connect the headphone end to the headphone jack on your stereo system. Follow steps 4-9 above.

From Computer

You can record audio from your computer using a headphone/line out 3.5 mm to mini-Line In cable.

1. Make sure your Thomson Lyra AV Jukebox is off.
2. Connect the smaller end of the cable (mini-Line In) to the LINE IN jack on your Thomson Lyra AV Jukebox.
3. Connect the other end to the headphone or line out jack on your computer.
4. Turn on the power to your computer, and select the file you want to record.

Follow steps 5-9 of *From Stereo System*.

Downloading Audio Files to Your Thomson Lyra AV Jukebox

You can download audio files from your computer using the supplied USB cable if your computer has a USB port. You can also insert a CompactFlash memory card to the CompactFlash port and use the supplied USB cable to download audio files to the CompactFlash memory card. Go to page 13 for more information.

Playing Your Thomson Lyra AV Jukebox in Your Car Stereo

The cassette adapter lets you listen to the Thomson Lyra AV Jukebox in an automobile or RV safely without having to wear headphones.

The car kit is included with your Thomson Lyra AV Jukebox. This accessory kit includes a car cord adapter and a cassette adapter. The car cord adapter lets you power your Thomson Lyra from the cigarette lighter socket of a car, truck, or RV. It converts 12-volts to a 4.5-volt output.

1. If the headphones are attached, remove them. Insert the plug on the cassette adapter into the headphone jack on the player.
2. Set your cassette player to your normal listening level.
3. Insert the cassette (Side A up) into your cassette player making sure the cord is placed in the correct position for your type of player.
4. Attach the end of the car cord adapter to the DC IN jack on your Thomson Lyra AV Jukebox.
5. Remove the cigarette lighter from the socket, and insert the car cord into the socket.
6. Turn on your Thomson Lyra AV Jukebox, and operate the Thomson Lyra AV Jukebox to play music as described earlier in the chapter.
7. Control the volume with the cassette player.
8. When you're finished,
 - A. Remove the cassette adapter from the cassette player.
 - B. Turn off the Thomson Lyra AV Jukebox.
 - C. Remove the car cord's plug from the cigarette lighter socket.

Cautions: Make sure to place the wire securely into the slot on the cassette in the correct direction for the type of player you have.

The car cord adapter is designed to be used only with vehicles having negative ground electrical systems. Use of any other car cord adapter may damage your Thomson Lyra AV Jukebox and void your warranty.

Playing Your Thomson Lyra AV Jukebox on Your Stereo System

Your Thomson Lyra AV Jukebox came with a Line Out Cable that you can use to connect your Thomson Lyra to your audio system.

1. Make sure your Thomson Lyra AV Jukebox is off.
2. Connect the 2.5mm mini-plug end of the cable to the LINE OUT jack on your Thomson Lyra AV Jukebox player.
3. Connect the red (audio right) and white (audio left) cables to the corresponding right and left audio jacks on your stereo system.
4. Turn on the power to your audio system, and select the proper input setting on the audio system that corresponds with the way you've connected the Thomson Lyra AV Jukebox to the audio system.
5. Turn on your Thomson Lyra AV Jukebox – press and hold **Ⓢ** for 2 seconds.
6. Operate the Thomson Lyra AV Jukebox to play music as described earlier in the chapter.

Viewing Photos

To select and view a photo from the Main Menu:

1. Press the up or down arrow to highlight *Photos* and press SELECT. Photos or photo folders appear on the left side of the screen.



2. Press the down arrow button to highlight the photo or photo folder you want to select, for example, *FlowerGarden*. The following appears:



- A list of photos and sub-folders appear on the left side of the screen. Press the right arrow to display the files under sub-folder. The photos appear on the right side of the screen.
3. Press the right arrow to access the list of photos under the folder (the photos appear on the right side of the screen).
 4. Continue to press the up or down arrow to highlight a sub-folder or photo file. Once you select what you want to view, press SELECT to display the Options menu (or press Play/Pause to view the file and the Options menu won't appear). The Photos Options menu descriptions follow:



Highlight *Play* and press SELECT to view the photo.

Highlight *Exit* and press SELECT to return to the last viewed Photo menu.

Highlight *Add to Favorites* to add the photo to your favorites list in the Photos system folder. (Feature currently not available. Visit <http://www.thomson-lyra.com> for the latest software and updates).

Highlight *Add to User Playlist* to add the photo to your playlist file in the Photo system folder. (Feature currently not available. Visit <http://www.thomson-lyra.com> for the latest software and updates).

Highlight *Program Play* to play tagged photo files. (Feature currently not available. Visit <http://www.thomson-lyra.com> for the latest software and updates).

Highlight *Move To* and press SELECT if you want to move the photo to a different folder.

Highlight *Delete* and press SELECT to delete the photo from the folder.

Highlight *Create Folder* to make a new folder. (Feature currently not available. Visit <http://www.thomson-lyra.com> for the latest software and updates).

Downloading Photos From Computer

You can download photo content from your computer using the supplied USB cable if your computer has a USB port. You can also insert a CompactFlash memory card to the CompactFlash port and use the supplied USB cable to download photo content to the CompactFlash memory card. Go to page 13 for more information.

Note: You can view photos directly from the CompactFlash memory card without having to transfer the content to the Thomson Lyra AV Jukebox hard drive.

Creating Photo Slideshow

To create a slideshow based on folder contents:

1. Go to the *Slideshow Settings* option under the *Photos Settings* in the *Setup* menu (go to Chapter 2 for more information).
2. Select *ON*, then set the *Interval* option. Set the *Mode* option to *All* (plays one time) or *Rep-All* (repeats slideshow continuously).
3. Go back to the Main Menu and highlight the *Photos* option, then press SELECT.
4. Select the folder, or the file within a folder, you want to base the slideshow on, and press the Play/Pause button to start playback.

The slideshow plays all photo files within the selected folder. Each photo is displayed for the length of time set in the *Interval* option.

Viewing Photo Slideshow

Slideshow options are set through the *Photos Settings* in the *Setup* menu (go to Chapter 2 for more information). The folder you select from the Photos system folder will play based on the interval and mode you set. A slideshow is similar to a video in that you can press the forward or reverse button at any time to go to the next or previous photo in the slideshow. You can also press the Play/Pause button to pause playback of the slideshow.

Viewing Photo Slideshow With Music

An audio slideshow is set through the *Photos Settings* in the *Setup* menu (go to page Chapter 2 for more information). You need to set a slideshow first and then you can add audio to the slideshow from the *Play Audio File* in the *Setup* menu.

Viewing Photos on Your TV

You can view photos stored on your Thomson Lyra AV Jukebox using the supplied Line Out cable if your TV has Audio and Video Input jacks.

1. Make sure your Thomson Lyra AV Jukebox is off.
2. Connect the 2.5mm mini-plug end of the cable to the LINE OUT jack on your Thomson Lyra AV Jukebox player.
3. Connect the yellow (video) to the Video Input jack. Connect the red (audio right) and white (audio left) cables to the corresponding right and left Audio Input jacks on your TV.

Note: If an audio file has been set to the slideshow, make sure the Audio Input jacks are properly connected to ensure you will hear the audio content.

4. Turn on the power to your TV, and change to the corresponding input channel on your TV.
5. Turn on your Thomson Lyra AV Jukebox. Switch the Mode Switch to TV OUT.
6. Highlight and select *Photos*.
7. Find the file you want to view on the TV. Press the SELECT button to view the individual file, or press Play if the slideshow option has been set.

Viewing Files

Files mode allows you to access all the contents on your hard drive. To view all files from the Main Menu:

1. Press the up or down arrow to highlight *Files* and press SELECT. All available folders are listed first (in alphabetical order), followed by all file items (in alphabetical order). If a CompactFlash memory card is inserted, it will be listed at the top of the list.



2. Press the down arrow button to highlight the file or folder you want to select, for example, *Folder 1*.
3. Press the right arrow to display the list of files under the folder (the files appear on the right side of the screen).
4. Continue to press the up or down arrow button to select a photo, song or video file. Once you select what you want to view or play, press SELECT to display the Options menu (or press Play/Pause to start playback and the Options menu won't appear). The Files Options menu descriptions follow:



Highlight *Play* and press SELECT to view or play the file.

Note: If you have a file, such as *expense.xls*, in your folder, the file can't be viewed on the Thomson Lyra AV Jukebox.

Highlight *Exit* and press SELECT to return to the last viewed File menu.

Highlight *Add to User Playlist* to add the file to a playlist file. (Feature currently not available. Visit <http://www.thomson-lyra.com> for the latest software and updates).

Highlight *Move To* and press SELECT if you want to move the file to a different folder.

Highlight *Copy To* and press SELECT if you want to copy the file to another folder.

Highlight *Copy All* and press SELECT if you want to copy all files in the current selected folder to another folder.

Highlight *Delete* and press SELECT to delete the file from the folder.

Highlight *Create Folder* to make a new folder. (Feature currently not available. Visit <http://www.thomson-lyra.com> for the latest software and updates).

Portable Hard Drive Capability

When connected to a computer via USB, the Thomson Lyra AV Jukebox is capable of storing any file type allowing the user a fast, convenient method of storing, retrieving, and transferring files. Including word processing files, presentations, spreadsheets and any other computer files.

Some possible uses for this feature are as follows:

- Create back-ups/archive files.
- Transport digital photo albums.
- Transport files from one computer to another computer. For example, instead of copying files at work onto a zip disk or accessing them on your home computer via e-mail or remote access, you can copy the files directly to your Thomson Lyra AV Jukebox and access from both work and at home.
- Store Internet downloads.
- Share information.

CompactFlash High-Speed Card Reader

The Thomson Lyra AV Jukebox also functions as a high-speed CompactFlash card reader when a CompactFlash memory card (Type-I) is properly inserted into the device.

If a CompactFlash memory card is properly inserted and the device is connected through USB to a computer, an additional drive will be accessible through Windows Explorer (on the Desktop for Mac Users) to transfer content to and from the card. All files types, not just multimedia files, may be stored on the card.

NOTE: *CompactFlash memory cards MUST be formatted in FAT16 in order to be properly detected. Other formats may result in device errors.*

Tips and Troubleshooting

Problem: Songs aren't listed in any of the audio sort modes (Album, Genre, Title, Audio Files).

- The audio contents of the Thomson Lyra AV Jukebox haven't been profiled (sorted) since the last file transfer. From the Lyra System Application on your PC, select the *Profile Device Contents...* option to sort (profile) the audio contents of the hard drive. The icon in the system tray looks like this .

Problem: Lyra Jukebox Profiler application icon  doesn't appear in the system tray.

- You can restart Windows to auto-launch the application, or you can double-click or run the Thomson Lyra Jukebox executable file that's in the Lyra Jukebox sub-folder of the installation directory that was specified during the setup process – (Example Directory: C:\Program Files\Thomson\Lyra Jukebox\LyraHDTrayApp\LyraHD2TrayApp.exe).

If the problem persists, you might need to reinstall the Thomson Lyra AV Jukebox software.

Problem: Thomson Lyra AV Jukebox does not respond.

- When this happens, you can recover the unit by inserting a sharp object (e.g. paper clip) into the Reset hole, located on the bottom side of the unit to reset the device. Press ON/OFF to turn device back on.

Problem: Some .AVI video files do not play on my Thomson Lyra AV Jukebox.

- Make sure the video is encoded in MPEG4 and the audio is encoded in mp3 audio. The .AVI files may be encoded in audio/video formats that are not currently supported by the Thomson Lyra AV Jukebox device.

Note: The Thomson Lyra AV Jukebox can play MPEG4 video content encoded with the DivX 4/5 codecs.

Problem: Can't hear audio on my Video file

- Make sure the audio has been encoded in mp3 audio.
- If connected to an audio/video component using the Line Out cable, make sure the cable is properly connected. See page 22 for more details.

Problem: Video picture doesn't fill up the entire LCD screen.

- If the video you recorded was created, from the computer, for example, the video frame size should be 320 pixels (width) by 240 pixels (height) for optimal video playback.

Problem: Photo files don't fill up the entire LCD screen.

- The photo size should have a 4:3 aspect ratio such as 640 pixels (width) by 480 pixels (height) for optimal photo playback.

Problem: Audio files added to the hard drive through Windows Explorer via drag and drop do not appear in Audio navigation sorting categories (Artist, Album, Genre, etc.).

- The audio content of the Thomson Lyra AV Jukebox hasn't been profiled. From the Lyra System Application on your PC, select the *Profile Device Contents...* option to sort (profile) the contents of the hard drive (go to Chapter 1 for details).

Problem: Video files added to the hard drive through Windows Explorer via drag and drop do not appear in Video navigation mode.

- Video content must be stored on the hard drive in the VIDEO system folder in order to be properly recognized and available for playback. Sub-folders may be created under the VIDEO system folder for easy navigation and organization of your video files.

Problem: Photo files added to the hard drive through Windows Explorer via drag and drop do not appear in Photos navigation mode.

- Photo content must be stored on the hard drive in the PHOTOS system folder in order to be properly recognized and available for playback. Sub-folders may be created under the PHOTOS system folder for easy navigation and organization of your photo files.

Specifications & System Requirements

Hardware

- Dimensions: 24.13mm D, 136.4mm W, 79.5mm H
- Unit Weight: 368.55 grams
- 20 Giga Byte Storage (1GB= 1 x 10⁹ bytes)
- Stereo Headphone Jack
- Mini USB Connection Jack
- Audio/Video Line Out Jack
- Audio/Video Line In Jack
- Battery Operated: Internal rechargeable lithium ion battery.

Hard Disc

- External Hard Disc Drive: When connected to a computer via USB, the Thomson Lyra AV Jukebox is capable of storing any file type allowing the user a fast, convenient method of storing, retrieving, and transferring files. Including word processing files, presentations, spreadsheets and any other computer files.
- Capacity: 20 Giga Byte (1GB= 1 x 10⁹ bytes)
- Rotational Speed: 4200 RPM
- Average Access Time: 12 MS
- Connection: USB 2.0 High-speed data transfer

NOTE: If formatting the Thomson Lyra AV Jukebox hard drive, the format must be in FAT32 in order for the device to function properly. Other formats will result in device failure and possible loss of data.

Software

- Includes Music Management software with the Thomson Lyra Jukebox applications and the MusicMatch Jukebox software.
MusicMatch Jukebox software lets the user organize all tracks in a digital music library, create custom playlists through drag and drop interface.
 - Encodes mp3 and mp3PRO files.
 - Auto DJ creates automatic Playlists based on the user's sorting preferences. Scans the entire Music Library for specific search results.
 - Integrated CD Player.
 - Export to WAV
 - mp3 Equalizer
 - Additional software/services included: *Install ID3man Auditude, Get 100 Free mp3 Tracks from eMusic, Install Moodlogic Mix and Transfer, or Try RHAPSODY Music Service*

PC Hardware Requirements

- Pentium III 500 MHz or higher recommended
Macintosh iMac G3 or higher
- Windows® 98SE, Me, 2000 with Service Pack 3, or XP
Mac OS X Version 10.1.5 or higher
- Internet Explorer 4.0 or higher
- Internet access

Additional Information

- 100 MB free hard disk space for the software
- 64 MB RAM (128 MB recommended)
- CD-ROM drive capable of digital audio extraction
- USB port (2.0 recommended)
- Installed sound card
- 16-bit color video card

Accessories

- CD-ROM Music Management Software
- Mini USB Connection Cable
- AC/DC Adapter
- Ear buds
- Audio/Video Line-In Cable
- Audio/Video Line-Out Cable
- Car Adapter Kit
- Carrying Case

Miscellaneous Specifications

- Signal to Noise Ratio (>85dB)
- THD (<0.1%)

Thomson Helpline



HELPLINE THOMSON

Votre Contact THOMSON : 0 826 820 456
(pour la France 0,15 € / mn)

Ihr Kontakt zu THOMSON: 0180 1000 390, ab 16.10.2000.
(für Deutschland, Kosten zum Ortstarif)

You can contact THOMSON by dialling: 0871 712 1312
(For Great-Britain, all calls will be charged 0,10£ / mn)

Para contactar con THOMSON marque: 901 900 410, a partir del 16.10.2000
(las llamadas serán cargadas al precio de la tarifa local)

Il vostro contatto THOMSON: 8488 10 168, dal 16.10.2000
(tariffa chiamata urbana)

www.thomson-europe.com

Repair Centers - Hungary

THOMSON SZERVÍZLISTA			
Szervíz	Helység	Cím	Telefon és fax
Major Ferenc e.váll.	Baja	Bara u. 4/D.	79/424-627 T/F
Belka Kft.	Baja	Jelky tér 1.	79/322-333
HIFI-TV-VIDEO	Barcs	Köztársaság u. 7.	(82) 461-680
Infra-Vízió Kft.	Békéscsab	Luther u. 18.	66/441-665 T/F
JUHÁSZ Elektronika	Békéscsab	Kölcsey u. 17.	(66) 324-419
Vidi-Vill Kft.	Budapest	Akácfa u. 6.	1/3229-698T, 3420-530
Kordován Tv. Kft.	Budapest	Kordován tér 2.	1/3806-223T, 3806-965
TV-Video Mester Sz.	Budapest	Rétköz u. 18.	1/2466-000 T/F
SERELCO Szervíz	Budapest	Diószeghy. u. 18.	333-9575, 477-2070,
Camcorder Kft.	Budapest	Budafoki u.35	466-8684, 209-2462/F
Speciál Hírad.Tech.	Budapest	Keleti Károlyu.13	315-0306
SZIGNÁL Szervíz	Dabas	Bem u. 28.	29/362055
Szigi-Vill Bt.	Debrecen	Darabos u. 18.	52/413-406T, 319-810F
CIVIS Kft.	Debrecen	Eötvös u.70	52/555-800
LASSIE Bt.	Diósd	Balatonai út 28.	(23) 380-382
MCSB Bt.	Dunaújváros	Petőfi u.2/a	25/287-074 T/F
SZERVÍZ 96 Kft.	Eger	Reményik u. 18.	(36) 313-333
R-NI 98 Bt.	Gyöngyös	Csokonai u. 2.	(37) 500-180
Video-Quadró Kft.	Győr	Lajta u. 2.	96/418-736T, 415-798F
SERELCO	Győr	Nagy i. U.61	96/ 527-517
TRANS-SAT 2000	Nagykanizsa	Csengery u. 33.	(93) 318-416
K.SZ.K. Kft.	Kalocsa	Obermayer tér 7.	(78) 462-480
TV-Video Kft.	Kaposvár	Nádor u. 51.	82/321-526T, 421-526F
KAPOS Enter Kft.	Kaposvár	Zárda u. 18.	(82) 429-306
Electro Record Sz	Kecskemét	Arany J. u. 6.	(76) 484-939
Video-Foton Bt.	Keszthely	Kossuth u. 45.	83/312-867 T/F
Krausz és Tsa.	Kiskunhalas	Táncsics M. u. 6	77/421-972 T/F
Video-Phone Kft.	Kikunfélygh.	Kossuth u.6	76/461 984
ZELKA Rt.	Lenti	Dózsa Gy. út 1.	(92) 351-160
Rádió-Tv. Kft.	Miskolc	Kis-Hunyad u. 52.	46/506-129 T, 340-293
Kisjós István e.váll.	Nagykanizsa	Órház u. 4.	93/322-507T, 314-104F
CLANETT Bt.	Nyergesújfal	Diófa u. 15.	(33) 356-633
Mihalkó György	Nyíregyháza	Hősök tere 15/a	42/411-358T, 314-521F
TECHNO-SAT Kft.	Nyíregyháza	Pacsirta u.36	(42) 504-432
MŰSZAKI Bolt	Orosháza		(68) 411-551
Video Klinika	Pápa	Törökbálint u. 7.	89/310-150 T/F
SIGNÁL TV Bt.	Pápa	Eötvös u. 6.	(89) 324-950
T+T TV Szervíz	Pécs	Hungária u. 13.	72/314-044T, 213-941
SERELCO	Pécs	Szabadság u.33	72/212-354
TV-SZER Bt.	Salgótarján	Kassai sor 4.	32/311-750T, 311-021
Javitó Karban	Salgótarján	Úttörők útja 31/A	(32) 310-027
Primvill Kft.	Soltvadkert	Kossuth u.15	78/482-349
Serelco	Szeged	Berlini Krt.6	62/420019
Ekron Bt.	Szekszárd	Rákóczi u. 31.	74/316-723T, 316-864
MIKRO-VIDEO Kkt.	Szekszárd	Kossuth L. u. 3.	(74) 312-214
Motesiczky Pál	Szentendre	Janicsár u. 1.	(26) 313-915
Commission Bt.	Szentes	Kossuth u. 11.	63/313-151 T/F
ELEKTRONIKA	Szentes	Honvéd u. 10.	(63) 400-184
Mega-Mikro Kft	Székesfehérvár	Bátky Zs. U.1	(22) 505-245,246
Videoton Kft	Székesfehérvár	Berényi út. 72-100	22/ 533-680
INFOTECH	Szolnok	Ostor u. 2.	(56) 343-185
Rátel Kft.	Szombathely	Kőszegi u. 2-6.	94/312-345T, 328-919
H & K Elektronika	Szombathely	Puskás Tivadar u 7	(94) 322-203
Elka Kft.	Tatabánya	Komáromi u. 27.	34/316-188,311-777
Pajor & Tsa. Bt.	Vác	Radnóti tér 6	(27) 314-274
Vermes András	Veszprém	Templom u. 3.	88/425-405 T/F
Zsámboki TV. Szer	Vitnyéd	Szent István u. 18.	96/242-395 T/F
ZELKA Rt.	Zalaegerszeg	Mártírok útja 9.	(92) 550-629

Additional Information

Repair Centers - Poland

Miasto	Nazwa firmy	Adres	Tel.Kier	Telefon
Biała Podlaska	SERWIS THOMSON	ul. Chełmońskiego 1	0-83	3420461
Białystok	PPU.H. PERFEKT	ul. Brukowa 7	0-85	7420628
Bielsko-Biała	ELEKTRONIK SERVICE	ul. Legionów 50	0-33	8166065
Bydgoszcz	TV COLOR-SERWIS	ul. B. Zaleskiego 12	0-52	3795597
Bydgoszcz	NOWA TECHNIKA	ul. Kijowska 90	0-52	3424822
Chełm	ZAKŁAD RADIOWO-TELEWIZYJNY	ul. Różana 18	0-82	5633500
Częstochowa	VALVO	Al. Niepodległości 30	0-34	3632868
Ełbląg	SERVICE AB - FILIA	ul. Leszno 6	0-55	2362154
Gdańsk	SERVICE AB - FILIA	ul. Grunwaldzka 132	0-58	3413531
Gdynia	SERVICE AB	ul. Indyjska 15	0-58	6218344
Gliwice	FIRMA HANDLOWO-USŁUGOWA	ul. Chorzowska 1	0-32	2315814
Gorzów Wlkp.	UNITRONIX-SERWIS	ul. Słoneczna 3	0-95	7227806
Grudziądz	AUDIO VIDEO THOMSON SERWIS	ul. Pańska 25	0-56	4623228
Jelenia Góra	"FELIX" ZAKŁAD USŁUGOWO-HANDLOWY RTV	Pl. Ratuszowy 5/6	0-75	7523062
Katowice	ELEKTRONIK SERWIS PLUS	ul. Gliwicka 65	0-32	2543560
Katowice	ZAKŁ. USŁUG RTV I AGD	ul. Kujawska 1 C	0-32	2589472
Kielce	ELECTRONIC SERVICE	ul. Mickiewicza 10	0-41	3445539
Kielce	MDS ELEKTRONIK	ul. Manifestu Lipcowego 73	0-41	3623936
Konin	SERVICE WMW	ul. Legionów 23	0-63	2493704
Koszalin	TELSERWIS	ul. Małopolska 1c/3	0-94	3461629
Kraków	MIX-SERWIS	ul. Włodowska 8A	0-12	2690942
Kraków	ASTEL S.C.	ul. Bałuckiego 9	0-12	2660999
Kraków	ASTEL S.C.	ul. wietokrzyska 10	0-12	6324018
Krasnystaw	ZAKŁAD USŁUG RTV	ul. Poniatowskiego 19	0-82	5763007
Krosno	RAGZ - FILIA	ul. Wojska Polskiego 40	0-13	4362959
Leszno	EURO ELEKTRONIK	ul. Złotnicza 44	0-65	5287323
Lubin	MULTISYSTEM SERWIS	ul. Paderewskiego 10	0-76	8444711
Lublin	UNITRA ELTRON SERWIS	ul. Braci Wieniawskich 5	0-81	7422999
Lublin	DUCAT SERWIS	ul. Choiny 1	0-81	741 30 81
Łódź	W & W	ul. Organizacji "WiN" 52	0-42	6576267
Łódź	W & W	ul. Piotrkowska 235/241	0-42	6370337
Łódź	RAGZ	ul. Piłsudskiego 143	0-42	6763038
Mława	AUTORYZOWANY SERWIS RTV-SAT	ul. Piłsudskiego 42	0-23	6544972
Nowy Sącz	EURO SERWIS	ul. Wiejska 6	0-18	4430335
Nowy Targ	SERVIS RTV i AGD	ul. Szaflarska 93d	0-18	2665013
Olsztyn	ZBYSZKO	ul. Gałczyńskiego 1/19	0-89	5277566
Opole	SYNCHRO	ul. Sz. Szeregów 23	0-77	4559254
Ostrołęka	TELE AUDIO VIDEO	ul. Bogusławskiego 13	0-29	7643781
Ostrów Wielkopolski	SERWIS RTV	ul. Kompały 3	0-62	7367644
Piaseczno	BWM-ELEKTRONICS - FILIA	ul. Jana Pawła II 24 lok.2	0-22	7368757
Piła	TELS	ul. Ojca M. Kolbe 13	0-67	2126292
Piotrków Tryb.	RAGZ - FILIA	ul. Kostromskiej 24	0-44	6476870
Poznań	NIKU SERWIS	ul. Składowa 5	0-61	8523078
Poznań	AKWA ELECTRONIC	ul. Otwocka 8	0-61	8708049
Radom	METRO	ul. Focha 12, pawilon 26	0-48	3634820
Rybnik	ELEKTRONIK SERWIS PLUS - FILIA	ul. Zamkowa 6	0-32	4235413
Rzeszów	VIDEO-SERVICE	ul. Leszczyńskiego 6	0-17	8534668
Siedlce	TOP-SERVICE	ul. Czerwonego Krzyża 14/11	0-25	6339826
Siemianowice Śląskie	KMA ELECTRONICS	ul. Fojkisa 8	0-32	2201400
Sieradz	SOKAL S.C.	Al. Pokoju 11	0-43	8224050
Słupsk	VIDEOSONIC	ul. Dmowskiego 10	0-59	8455563
Suwałki	TELE-VIDEO SERWIS	ul. Gen. Andersa 7	0-87	5671518
Szczecin	ZURIT SERWIS	ul. Chopina 22	0-91	4525399
Szczecin	PHU HIT-SERVICE	ul. Szwolężerów 22	0-91	4333741
Tarnobrzeg	SERVIS TV-VIDEO	ul. Wyspiańskiego 9 paw. I	0-15	8221075
Tarnów	TEKIELAND-ELECTRONIC	ul. Kopernika 4	0-14	6223812
Toruń	FHU OMPEX	ul. Hallera 65/3	0-56	6520696
Wałbrzych	NAREL	ul. Mickiewicza 18	0-74	8426216
Warszawa	ASEL	ul. Gen. Abrahama 2b	0-22	6710958
Warszawa	AST	ul. Obozowa 82a	0-22	8361870
Warszawa	BWM-ELEKTRONICS	ul. I. Gandhi 17	0-22	6446156
Warszawa	NOWA TECHNIKA	Pl. Inwalidów 10	0-22	8398379
Warszawa	NOWA TECHNIKA	ul. Białostocka 5	0-22	6185270
Warszawa	NOWA TECHNIKA	ul. Żelazna 58/62	0-22	6243970
Włocławek	FC TRONIK	ul. Wiejska 24	0-54	4118788
Wrocław	THOM-SERWIS	ul. Szczytnicka 30	0-71	3277981
Wrocław	SERWIS ELEKTRONICZNY	ul. Hauke-Bossaka 6	0-71	3429296
Zamość	TELERADIOMECHANIKA	ul. Piłsudskiego 31	0-84	6395000
Zielona Góra	JANCOL	ul. Dąbrowskiego 35	0-68	3245137

Wyrób importowany przez
Thomson multimedia Polska Sp. z o.o.
Oddział Consumer Products Marketing & Sales.

Repair Centers - Russia

Страна	Город	Сервисный Центр	Адрес	Телефон
Белоруссия	Минск	ЦТИ	ул. Короля, 26	(017) 2105678, 2893944
Молдавия	Кишинев	ACO-SERVICE-ELECTRON S.R.L.	ул. Банулеску Бодони 45	(373) 222-40-35
Россия	Абакан	Кристалл	ул.Пушкина, д.54	(39022) 6-85-81, 4-34-21
Россия	Алметьевск	Эль-Мастер	ул. Р. Фахретдина, 24	(85512) 51919
Россия	Архангельск	Двина-Сервис	ул. Урицкого, 54	(8182) 265355
Россия	Балаково	ЧП Дунаев	ул. Н. Леонова, д. 1а Д/К Химикив	(845-70) 2-33-06
Россия	Балашиха	Кан-Сервис	ул. Калинина, д. 1	(095) 523 3313
Россия	Барнаул	Ремикс	ул. Пушкина, 37	(3852) 231241
Россия	Белгород	Видео-Плюс	ул. Богдана Хмельницкого, 86	(0722) 268896
Россия	Березники	ЧП Меркулов	Советский проспект 50	(242) 6-21-21
Россия	Владивосток	Диапазон-Сервис	ул. Баляева, 58	(4232) 215287
Россия	Владимир	Ромашка	ул. Горького, 32	(0922) 330798, 331391
Россия	Волгоград	Про-Сервис	ул. Рабоче-Крестьянская, 14	(8442) 445281
Россия	Воронеж	Орбита-Сервис	ул. Донбасская, 1	(0732) 774329, 776625
Россия	Воронеж	Эль-Сервис	Ленинский проспект, 172	(0732) 54-32-91
Россия	Екатеринбург	Сентри	пр-т Космонавтов, 45	(3432) 310336, 32 05 71
Россия	Екатеринбург	Сентри	ул. Орджоникидзе, 26	(3432) 310336, 32 05 71
Россия	Ижевск	Лэсси	ул. Пушкинская, 216	(3412) 438805
Россия	Иркутск	ТИС	ул. 5-ой Армии, 12	(3952) 333859
Россия	Иркутск	ТИС	ул.Партизанская, 149	(3952) 51-31-09
Россия	Йошкар-Ола	Эль-Мастер	ул. Советская, 116	(8362) 120912
Россия	Казань	ТВС	ул. Шамиля Усманова, 32а	(8432)44-10-51
Россия	Казань	ЭЛЬДОРАДО-СЕРВИС	ул. Р.Зорге, д.95	(8432) 685005
Россия	Калининград	Вестер-Сервис	ул. Горького, 50	(0112) 273432, 273151
Россия	Кемерово	Вайд Сервис	ул. Коммунистическая 122	(3842) 258523
Россия	Комсомольск-на-Амуре	Инсайт-Сервис	Мира пр-т, 9	(42172) 4 60 58
Россия	Красноярск	Интернационал Сервис	ул. Вильского, 3	(3912) 453305
Россия	Красноярск	Интернационал Сервис	ул. Карла Маркса, 44	(3912) 453305
Россия	Курск	Экран-Сервис Добролюбова	ул., 17	(0712) 22 33 80, 56 0053
Россия	Липецк	Владон Меркулова	ул., 8	(0742) 41 06 94
Россия	Магадан	Центр-Видео-Сервис	Кольимское шоссе, д. 4	(413-22) 4-11-74
Россия	Магадан	Центр-Видео-Сервис	ул. Карла Маркса, 33/15	(41322) 23322
Россия	Магнитогорск	Эль-Мастер	ул. Ленинградская, 34	(3511) 227878
Россия	Москва	Авакс	Хорошевское шоссе, 33/1	(095) 195 41 13, 195 2593
Россия	Москва	Интеррадиоприбор	проезд завода "Серп и молот", 5	(095) 3614933, 2733173
Россия	Москва	Интеррадиоприбор	ул. Мневники, 7 корп. 2	(095) 946 4604, 946 4504
Россия	Москва	КДС - Технический центр	Шелепихинская наб., 18	(095) 7973434
Россия	Москва	Лит-Сервис	Жулебинский б-р, 9	(095)705-4688, 705-0899
Россия	Москва	Лит-Сервис	б-р Дмитрия Донского, 2а	(095)711-8336, 711-5827
Россия	Москва	Лит-Сервис	ул. Братиславская, 14	(095)346-8744
Россия	Москва	Лит-Сервис	ул. Краснобогатырская 75	(095)269-2310, 966-3511
Россия	Москва	Мир и Сервис	Пролетарский пр. 23	(095) 3250305, 3253437
Россия	Москва	Партия-Сервис	ул. Академика Королева, д.5	913-33-88
Россия	Москва	Партия-Сервис	ул. Викторенко, д. 3	742-50-20
Россия	Москва	Партия-Сервис	ул. Исаковского, д. 33, корп. 4	757-50-00, 758-40-51
Россия	Москва	Партия-Сервис	ул. Марксистская, д.34	912-00-08, 911-67-80, 911-68-89/73
Россия	Москва	Партия-Сервис	ул. Народного Ополчения, д. 22, корп 2	787-70-21
Россия	Москва	Партия-Сервис	ул. Новопеределкинская, д. 9А	731-11-00
Россия	Москва	Партия-Сервис	ул. Обручева 30	(095) 9133939
Россия	Москва	Партия-Сервис	ул. Уральская, д. 1а	462-0041
Россия	Москва	Партия-Сервис	ул. Ярцевская, д. 30	149-23-31, 149-24-19
Россия	Москва	Экс-Сервис	ул. Врубеля, д. 12	(095)742-9081
Россия	Москва	Эль-Мастер	ул. Кулакова, д.20	(095) 7547007
Россия	Мурманск	СРС Мурманск	ул. Софьи Перовской, 37	(8152) 458701, 45 09 49
Россия	Н. Новгород	Электроника	ул. Алексеевская, 9	(8312) 19-41-08, 19-41-10
Россия	Н. Новгород	Электроника	ул. Лескова, 8	(8312) 59-46-20, 54-68-18
Россия	Набережные Челны	РАФТ	Новый Город, 28/08	(8552) 549823
Россия	Нефтеюганск	Эфир	13 микрорайон, 56	(34612) 54223
Россия	Новгород	ТКТ (Орбита)	ул. Кочетова 23а	(81622) 611200
Россия	Новокузнецк	Стратас	ул.Транспортная 49а	(3843) 78-71-95
Россия	Новосибирск	ЭЛЬ-СЕРВИС	ул.1-я Ельцовка, д.1	(3832) 285246
Россия	Новосибирск	Юса	Красный пр-т, 50	(3832) 180995, 181755
Россия	Омск	Телетекст-Сервис	пр-т Маркса, 18	(3812) 312530
Россия	Оренбург	Коминком	Брестская ул., 7	(3532) 626888, 627701
Россия	Орск	Коминком	Школьная ул. 13	(35372) 62631

Repair Centers - Russia

Страна	Город	Сервисный Центр	Адрес	Телефон
Россия	Пенза	ПТС	Московская ул., 18	(8412)662222
Россия	Пермь	ЛЭБТ	Бульвар Гагарина, 58а	(3422) 619400, 619480
Россия	Пермь	ЭЛЬДОРАДО-СЕРВИС	б-р Гагарина, д.32	(3422) 484477
Россия	Петрозаводск	ЛАНС	наб. Ла-Рошель, 17	(8142) 765150
Россия	Петропавловск-Камчатский	Мастерская №1	ул. Ключевская, 56, каб. 203	415-37-6-37
Россия	Ростов-на-Дону	AAA-Сервис	ул. Горького 136	(8632) 907900
Россия	Ростов-на-Дону	ЭЛЬСЕРВИС	ул. Красноармейская, д.206	(8632) 618066
Россия	Рязань	Фонограф	пл. 50-летия Октября, д.1	(0912) 721712
Россия	Самара	СЕРВИС-ЦЕНТР	ул. Республиканская, д.62	(8462) 538199
Россия	Самара	Энон-Сервис	ул. Советской Армии, 148	(8462) 240740
Россия	Саранск	Видео-Сервис	ул. В.Терешковой 18а	(834-22)4-54-85
Россия	Саратов	Скарт	пр-т 50 лет Октября, 110а	(845-2) 48-41-31,32-09-11,34-00-39
Россия	Сергиев Посад	Эль-Мастер	пр-т Красной Армии, 4	(09654) 60533
Россия	Сочи	Союз-Сервис	ул. Московская, 5	(8622) 920225
Россия	Ст.-Петербург	Орбис	Витебский пр-т 33 кор.2	(812) 379-5655
Россия	Ст.-Петербург	Орбис	Ланское шоссе 65	(812) 246-3793
Россия	Ст.-Петербург	Орбис	Октябрьская наб. 60	(812) 446-6171
Россия	Стерлитамак	Импорт - Сервис	ул. Коммунистическая, 61	(3473) 24 42 85
Россия	Тверь	Толубой Экран	пр. Победы, 2/2	(0822) 36 05 20
Россия	Тольятти	Мастер-Класс	ул. Карбышева, 6	(8482) 260595, 260065
Россия	Томск	Командор-Сервис	ул. Беленца, 14	(3822) 516-333
Россия	Тула	Омегамет	ул. Доватора, 1	(0872) 436158, 462466
Россия	Тюмень	Тюмень Импорт-Сервис	ул. Мельникайте, 97	(3452) 224596, 22 45 96
Россия	Тюмень	Тюмень трейд	ул. Герцена, д. 101	(3452) 46-41-06
Россия	Улан-Уде	МВ-Маркет	Гостиные ряды, "МВ-Маркет"	(3012) 211661
Россия	Уссурийск	Вега-Гарант	ул. Советская, 29	(42341) 21035
Россия	Усть-Илимск	Питон Офис 4,	ул. Мечтателей д. 21	(39535) 57147
Россия	Уфа	Техно	ул. Чернышевского, 88	(3472) 377303, 377344
Россия	Уфа	ЭЛЬДОРАДО-ЛЕНД	ул. Чернышевского, д. 100	(3472) 222448
Россия	Челябинск	Импорт-Сервис	ул. Энтузиастов, 16	(3512) 340505
Россия	Челябинск	ЭЛЬ-СЕРВИС	ул. Володарского, 32	(3512) 65-31-09
Россия	Энгельс	ЭПКСЦ "Гарант"	ул.Петровского,57	(845-11)6-42-37
Украина	Винница	СКОРМАГ-СЕРВИС	пр-т Юности, 16, к. 104	(0432) 46-43-93
Украина	Днепропетровск	МТІ	ул. Ленина, 21а	(0562) 37-13-60
Украина	Днепропетровск	СЕРВИСЦЕНТР	пл. Октябрьская, 2, офис 6.	(0562) 37-78-30
Украина	Донецк	Импорт-Сервис	пр-т Мира, 13	(062) 335-06-70
Украина	Житомир	ВЫБОР	ул. Победы, 32	(0412) 41-88-26
Украина	Запорожье	ТТП-94	ул.Грязнова, 71	(0612) 13-80-49
Украина	Ивано-Франковск	ООО "Мегастайл"	ул. Вовчинецкая, 172а	(03422) 6-15-30
Украина	Киев	Крок ТТЦ	пр-т Владимира Маяковского, 26	(044) 5450897
Украина	Кировоград	ДП "Инэк-Кировоград"	пр-т Коммунистический, 22/12	(0522) 22-06-21
Украина	Краматорск	Астрон	ул.Дворцовая, 6	(0626) 41-97-34
Украина	Кременчуг	ИНЭК-КРЕМЕНЬ	ул. Победы, 17/6	(05366) 3-11-21
Украина	Кривой Рог	ДОМТЕХСЕРВИС	ул. Волгоградская, 4	(0564) 74-36-15
Украина	Луганск	КОРСАК	ул. Коцюбинского, 27	(0642) 34-56-06
Украина	Луцк	ООО "Каскад-Интек"	ул. Гулака Артемовского, 15а	(0332) 77-99-55
Украина	Львов	МАРКЕТ-ЛЬВОВ	ул. Стороженко, 12	(0322) 33-70-63
Украина	Мариуполь	ООО "Нейтрон"	пр-т Металлургов, 94	(0629) 529282
Украина	Николаев	СЦ АЛЛАДИН	ул. Никольская, 46	(0512) 47-04-96
Украина	Николаев	ЧП Осипенко (Транзит)	пр. Ленина, 184	(0512) 57-52-35
Украина	Одесса	Профессионал	ул. Успенская д.24/26	0482) 42-91-52
Украина	Одесса	ЮГ СЕРВИС	ул. Лейтенанта Шмидта, 21	(0482) 37-54-66
Украина	Полтава	НПО "Промэлектроника"	ул.Фрунзе, 66	(05322) 7-81-55
Украина	Ровно	ОПАЛ	ул. С. Бандеры, 55	(0362) 62-04-01
Украина	Севастополь	ПАНОРАМА-С	ул. Генерала Петрова, 3 офис 1	(0692) 45-39-00
Украина	Северодонецк	Северодонецк радиотехника	ул. Маяковского, 13	(06452) 4-30-30
Украина	Симферополь	ГАРАНТ	ул. Павленко, 54	(0652) 52-15-08
Украина	Сумы	СЕРВИСЦЕНТР	ул. Героев Сталинграда, 3	(0542) 21-06-79
Украина	Тернополь	ТЕРНАВА-СЕРВИС	ул. Злуки, 39	(0352) 43-30-22
Украина	Ужгород	ПРОФИ-СЕРВИС	пл. Ш.Петефи, 47	(0312) 23-44-63
Украина	Харьков	БЕСТ	ул. Полтавский Шлях, 30	(0572) 12-38-60
Украина	Херсон	РАДИО	ул. Советская, 23	(0552) 22-57-30
Украина	Черкассы	ЕВРАЗИЯ-С	ул. Одесская, 8	(0472) 66-36-53
Украина	Чернигов	ЛАГРОС LTD	пр-т Мира, 80	(0462) 17-78-99
Украина	Черновцы	ЗДАМЕКС-ПЛЮС	ул. Русская, 198	(03722) 6-09-23
Украина	Ялта	Ави-Электроникс	ул.Жадановского, 3	(0654) 38-60-18

Repair Centers - Czech Republic

Seznam servisních partnerů - Česká republika				
Servisní partner	Město	Ulice	Telefon	PSČ
Prague				
NOVOTNÝ elektronik	Praha 4	Hvězdoslavova 1599	272 937 184, 272 942 516	
NOVOTNÝ elektronik	Praha 8	Zenklova 81	283 840 523, 284 840 158	
NOVOTNÝ elektronik	Praha 6 - Řepy	Makovského 1144	235,321,277	
NOVOTNÝ elektronik	Praha 4 - Chodov	Hráského 1909	271,913,629	
NOVOTNÝ elektronik	Vlašim	Poděbradova 358	317,844,844	
BELS CZ s.r.o. - Praha	Praha 4	Bělehradská 18	261,218,480	
DI servis	Praha 8	Pernerova 35	221 897 233-5	
AV Kosvoslužba	Praha 4	Cílkova 9/796	241,714,442	
Central Bohemia				
BELS CZ s.r.o. - Benešov	Benešov	Zapova 525	317,725,060	
TV-VIDEO centrum	Nymburk	Palackého 119	325,514,891	
ELECTRONIC SERVICE NOVAK	Příbram	Prokopská 4	318,625,052	
East Bohemia				
Jozef Ondruš - Radiotechnika	Pardubice	Tepleho 1398	466,303,951	
Jozef Ondruš - Radiotechnika	Hradec Kralové	Nerudova 155	495,530,073	
West Bohemia				
NELIN spol. s r.o.	Karlovy Vary	Krymská 47	353,222,028	
Televizní servis Ladislav Juppa	Plzeň	Lobezská 62	377 456 356, 377 443 545	
TOP Elektronik	Karlovy Vary	Moskevská 64	353224056, 353 230 337	
North Bohemia				
Horák electronics s.r.o.	Jablonec n. Nisou	Sadova 8	483,312,550	
Jiří Suchý servis video - televize	Česká Lípa	Kolarova 2059	487,832,064	
Jan Murga MJ* electronic - Stráž nad Nisou	Stráž nad Nisou	Myslbekova	485,159,301	
Jan Murga MJ* electronic - Liberec	Liberec	Na Perstyně 378/42	485,104,628	
RAMI Elektronik	Ústí n. Labem	Novosedlické nám. 1239/2	47 55 33 166	
TV servis - Vlček Lubomir	Chomutov	Kadanská 3259/3	474,629,223	
TV*VIDEO*SAT - V.Bloudek	Most	Moskevská 1/14	476,206,709	
VIDCOM ELEKTRONIK	Teplice - Prosetice	Plynarenská 280	417,531,555	
South Bohemia				
ELEKTRO STELA	Tábor	Údolní 2908	381,256,600	
ELEKTRO STELA	Malšice	Táborská 200	381,277,304	
Milan ČepI - ELEKTRONIKA	Humpolec	Rasínova 466	565 532 363, 565 532 021	
Video TV servis	České Budějovice	Na zlate stoce 14	385,310,165	
VOBUKO spol. s r.o.	Písek	Havlíčkovo nám. 92	382 215 356, 382 219 130	
South Moravia				
KNK servis	Brno	Bubeničkova 12/14	548 210 713, 548 213 870	
TEVIS BRNO s.r.o.	Brno	Blatného 2	541 240 003, 541 211 112 i fax	
Miroslav Drda - TELES RTS	Otrokovice	Olbrachtova 1621	577,922,677	
VIKI spol. s r.o.	Jihlava	Fritzova 12	567,303,546	
Rates s.r.o.	Hodonín	Havlíčková 2	518,341,300	
Belvis elektronika	Uherský Brod	Dlní valy 507	572,633,417	
North Moravia				
TELEVIIZE VIDEO SERVIS	Ostrava - Poruba	U oblouku 501/5	596,912,602	
KATEX s.r.o.	Šumperk	Nam. Republiky 8	583,212,807	
MONTAN RTS s.r.o.	Olomouc	Sokolská 8	585,220,312	
MONTAN RTS s.r.o.	Dolany 376	Dolany 376	585,396,512	
SOPRA s.r.o.	Opava	Komárovská 2	553 711 395, 553 620 207	

Visit us at www.thomson-europe.com or www.thomson-lyra.com

THOMSON
46, quai Alphonse Le Gallo
92648 Boulogne
Cedex FRANCE
55831210 (EN)
www.thomson.net