



Microwave Oven
INSTRUCTION MANUAL
MODEL: SMW730

Read these instructions carefully before using your microwave oven. Keep these instructions in a safe place for future reference. If you follow the instructions, your oven will provide you with many years of good service.

SAVE THESE INSTRUCTIONS CAREFULLY

TABLE OF CONTENTS

SAFETY

Proper and Safe Use of Your Oven-----	3
Important Safety Instructions-----	4
Grounding Installation -----	5
Utensils -----	6

SETTING UP YOUR OVEN

Names of Oven Parts and Accessories-----	7
Turntable Installation-----	8
Installation-----	8

OPERATION

Control Panel and Features-----	9
Operation Instructions-----	10

MAINTENANCE

Troubleshooting -----	17
Cleaning -----	18

PRECAUTIONS TO AVOID POSSIBLE EXPOSURE TO EXCESSIVE MICROWAVE ENERGY

- (a) Do not attempt to operate this oven with the door open since this can result in harmful exposure to microwave energy. It is important not to break or tamper with the safety interlocks.
- (b) Do not place any object between the oven front face and the door or allow soil or cleaner residue to accumulate on sealing surfaces.
- (c) Do not operate the oven if it is damaged. It is particularly important that the oven door closes properly and that there is no damage to the:
 - (1) DOOR(dent)
 - (2) HINGES AND LATCHES(broken or loosened)
 - (3) DOOR SEALS AND SEALING SURFACE
- (d) The oven should not be adjusted or repaired by anyone except properly qualified service personnel.

SPECIFICATIONS

Model:	SMW730
Power Source:	120V ~ 60Hz 2450MHz
Power Consumption:	1200 W
Maximum Output:	800 W
Oven Capacity:	0.7 Cu.ft.
Turntable Diameter:	∅ 245 mm
External Dimensions (LxWxH):	461 mm X 365 mm X 280 mm
Net weight:	Approx. 12.5 Kg

SAFETY

1. The oven must be on a leveled surface.
2. The turntable and turntable roller rest must be in the oven during cooking. Place the cookware gently on the turntable and handle it carefully to avoid possible breakage.
3. Incorrect use of browning dish may cause the turntable to break.
4. Use only the specified bag size when using Direct Access Popcorn.
5. The oven has several built-in safety switches to ensure that the power remains off when the door is open. Do not tamper with these switches.
6. Do not operate the microwave oven empty. Operating the oven with no food or food that is extremely low in moisture can cause fire, charring or sparking.
7. Do not cook bacon directly on the turntable. Excessive local heating of the turntable may cause the turntable to break.
8. Do not heat baby bottles or baby food in the microwave oven. Uneven heating may occur and could cause physical injury.
9. Do not heat narrow-necked containers, such as syrup bottles.
10. Do not attempt to deep-fry in your microwave oven.
11. Do not attempt home canning in this microwave oven as it is impossible to be sure all contents of the jar have reached boiling temperature.
12. Do not use this microwave oven for commercial purpose. This microwave oven is made for household use only.
13. To prevent delayed eruptive boiling of hot liquids and beverages or scalding yourself, stir liquid before placing the container in the oven and again halfway through cooking time. Let stand in the oven for a short time and stir again before removing the container.
14. Please do notice the food in the microwave oven to avoid burning due to excessive cooking when cooking food in it.
15. When the appliance is operated in the combination mode, children should only use the oven under adult supervision due to the temperatures generated.
16. Failure to maintain the oven in a clean condition could lead to deterioration of the surface that could adversely affect the life of the appliance and possibly result in a hazardous situation.

Important Safety Instructions

WARNING — To reduce the risk of the fire, electric shock, injury to persons, or exposure to excessive microwave oven energy when using your appliance, follow basic precautions, including the following:

1. Read all instructions before using the appliance.
2. Read and follow the specific: "**PRECAUTIONS TO AVOID POSSIBLE EXPOSURE TO EXCESSIVE MICROWAVE ENERGY**".
3. As with most cooking appliances, close supervision is necessary to reduce the risk of a fire in the oven cavity.
4. Do not use this oven to heat or cook flammable, explosive, or volatile liquids, or to heat or cook items that may explode and therefore should not be heated in this oven.
5. Use this appliance only for its intended uses as described in the manual. Do not use corrosive chemicals or vapors in this appliance. This oven is specifically designed to heat or cook food. It is not designed for industrial or laboratory use.
6. As with any appliance, close supervision is necessary when used by children.

If materials inside the oven ignite:

1. Keep the oven door closed
2. Turn the oven off, and unplug the appliance.
3. Disconnect the power at the fuse or circuit breaker panel.

Keep in mind the following rules at all times:

1. Do not overcook food. Carefully attend the appliance when paper, plastic, or other combustible materials are placed inside the oven to facilitate cooking.
2. Do not use the oven cavity for storage purposes. Do not store combustible items such as bread, cookies, paper products, etc. inside the oven. If lightning strikes the power line, the oven may turn on by itself.
3. Remove wire twist-ties and metal handles from paper or plastic containers/bags before placing them in the oven.
4. This oven must be grounded. Connect only to properly grounded outlet. See "**GROUNDING INSTRUCTIONS**".
5. Install or locate this oven only in accordance with the installation instructions provided.
6. Some products such as whole eggs, water with oil or fat, sealed containers and closed glass jars are able to explode and therefore should not be heated in this oven.
7. Use this appliance only for its intended uses as described in the manual. Do not use corrosive chemicals or vapors in this appliance. This oven is specifically designed to heat or cook food. It is not designed for industrial or laboratory use.
8. As with any appliance, close supervision is necessary when used by children.
9. Do not operate this oven if it has a damaged cord or plug, if it is not working properly or if it has been damaged or dropped.
10. This appliance should be serviced only by qualified service technicians. Contact the nearest authorized service facility for examination, repair or adjustment.
11. Do not cover or block any vents on the oven.
12. Do not store or use this appliance outdoors.
13. Do not use this oven near water, for example, near a kitchen sink, in a wet basement, near a swimming pool, or similar locations.
14. Do not immerse cord or plug in water.
15. Keep cord away from heated surfaces.
16. Do not let cord hang over edge of table or counter.
17. When cleaning door and oven surfaces use only mild, nonabrasive soaps or detergents applied with a sponge or soft cloth.

18. Liquids, such as water, coffee, or tea are able to be overheated beyond the boiling point without appearing to be boiling. Visible bubbling or boiling when the container is removed from the microwave oven is not always present. This could result in very hot liquids suddenly boiling over when the container is disturbed or a spoon or other utensil is inserted into the liquid.

To reduce the risk of injury to persons:

Grounding Installation

- i) Do not overheat the liquid.
- ii) Stir the liquid both before and halfway through heating it.
- iii) Do not use straight-sided containers with narrow necks.
- iv) After heating, allow the container to stand in the microwave oven for a short time before removing the container.
- v) Use extreme care when inserting a spoon or other utensil into the container.

SAVE THESE INSTRUCTIONS

DANGER

Electric Shock Hazard Touching some of the internal components can cause serious personal injury or death. Do not disassemble this appliance.

WARNING

Electric Shock Hazard

Improper use of the grounding can result in electric shock. Do not plug into an outlet until appliance is properly installed and grounded.

Three-pronged (grounding) plug

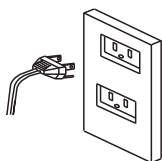

Properly polarized and grounded outlet

Utensils

This appliance must be grounded. In the event of an electrical short circuit, grounding reduces the risk of electric shock by providing an escape wire for the electric current. This appliance is equipped with a cord having a grounding wire with a grounding plug. The plug must be plugged into an outlet that is properly installed and grounded.

Consult a qualified electrician or serviceman if the grounding instructions are not completely understood or if doubt exists as to whether the appliance is properly grounded. If it is necessary to use an extension cord, use only a 3-wire extension cord that has a 3-pronged grounding plug, and a 3-slot receptacle that will accept the plug on the appliance.

1. A short power-supply cord is provided to reduce the risks resulting from becoming entangled in or tripping over a longer cord.
2. Longer cord sets or extension cord is provided to reduce the risks resulting from becoming entangled in or tripping over a longer cord.
3. If a long cord sets or extension cord is used: 1)The marked electrical rating of the cord set or extension cord should be at least as great as the electrical rating of the appliance. 2)The extension cord must be a grounding-type 3-wire cord, and 3)The longer cord should be arranged so that it will not drape over the counter top or tabletop where it can be pulled on by children or tripped over unintentionally.

CAUTION

Personal Injury Hazard

Tightly-closed utensils could explode. Closed containers are opened and plastic pouches pierced before cooking.

See below and the next page for further instructions “Materials you can use in microwave oven or materials to be avoided in microwave oven.” There may be certain non-metallic utensils that are not safe to use for microwaving. If in doubt, you can test the utensil in question following the procedure below.

Utensil Test:

1. Fill a microwave-safe container with 1 cup of cold water (250ml) along with the utensil in question.
2. Cook on maximum power for 1 minute.
3. Carefully feel the utensil. If the empty utensil is warm, do not use it for microwave cooking.
4. Do not exceed 1 minute cooking time.

Materials you can use in microwave oven

Utensils	Remarks
Aluminum foil	Shielding only. Small smooth pieces can be used to cover thin parts of meat or poultry to prevent overcooking. Arcing can occur if foil is too close to oven walls. The foil should be at least 1 inch (2.5cm) away from oven walls.
Browning dish	Follow manufacturer's instructions. The bottom of browning dish must be at least 3/16 inch (5mm) above the turntable. Incorrect usage may cause the turntable to break.
Dinnerware	Microwave-safe only. Follow manufacturer's instructions. Do not use cracked or chipped dishes.
Glass jars	Always remove lid. Use only to heat food until just warm. Most glass jars are not heat resistant and may break.
Glassware	Heat-resistant oven glassware only. Make sure there is no metallic trim. Do not use cracked or chipped dishes.
Oven cooking bags	Follow manufacturer's instructions. Do not close with metal tie. Make slits to allow steam to escape.
Paper plates and cups	Use for short-term cooking/warming only. Do not leave oven unattended while cooking.
Paper towels	Use to cover food for reheating and absorbing fat. Use with supervision for a short-term cooking only.
Parchment paper	Use as a cover to prevent splattering or a wrap for steaming.
Plastic	Microwave-safe only. Follow the manufacturer's instructions. Should be labelled “Microwave Safe”. Some plastic containers soften as the food inside gets hot. “Boiling bags” and tightly closed plastic bags should be slit, pierced or vented as directed by package.
Plastic wrap	Microwave-safe only. Use to cover food during cooking to retain moisture. Do not allow plastic wrap to touch food.
Thermometers	Microwave-safe only (meat and candy thermometers).
Wax paper	Use as a cover to prevent splattering and retain moisture.

Materials to be avoided in microwave oven

Utensils	Remarks
Aluminum tray	May cause arcing. Transfer food into microwave-safe dish.
Food carton with metal handle	May cause arcing. Transfer food into microwave-safe dish.
Metal or metal-trimmed utensils	Metal shields the food from microwave energy. Metal trim may cause arcing.
Metal twist ties	May cause arcing and could cause a fire in the oven.
Paper bags	May cause a fire in the oven.
Plastic foam	Plastic foam may melt or contaminate the liquid inside when exposed to high temperature.
Wood	Wood will dry out when used in the microwave oven and may split or crack.

SETTING UP YOUR OVEN

Names of Oven Parts and Accessories

Remove the oven and all materials from the carton.

Your oven comes with the following accessories:

Glass tray	1
Turntable ring assembly	1
Instruction Manual	1

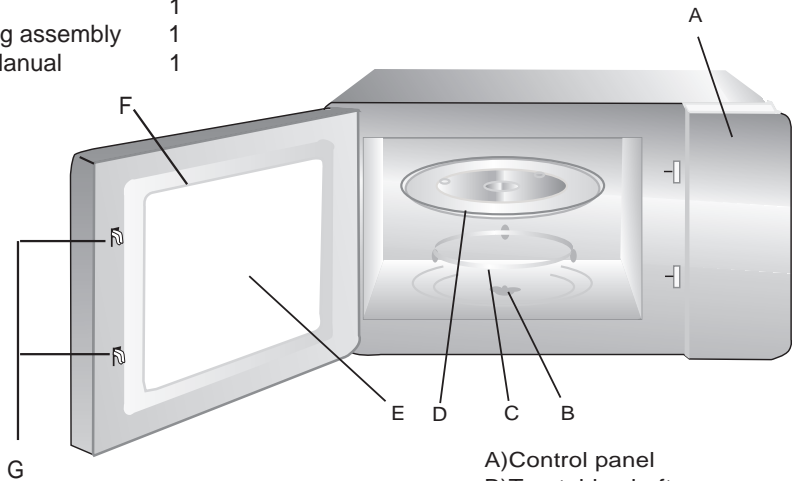

- A) Control panel
- B) Turntable shaft
- C) Turntable ring assembly
- D) Glass tray
- E) Observation window
- F) Door assembly
- G) Safety interlock system

TURNTABLE INSTALLATION

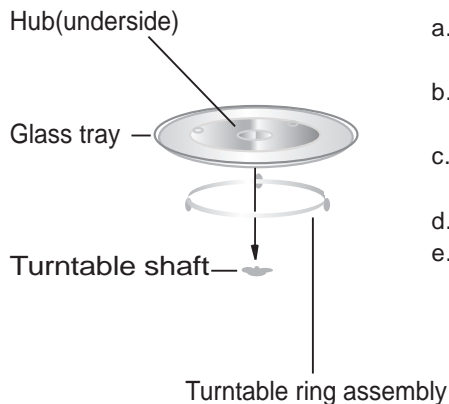

- Never place the glass tray upside down. The glass tray should never be restricted.
- Both glass tray and turntable ring assembly must always be used during cooking.
- All food and containers of food are always placed on the glass tray for cooking.
- The glass tray rotates clockwise; this is normal.
- If glass tray or turntable ring assembly cracks or breaks, contact your nearest authorized service center.

Installation

Remove all packing material and accessories. Examine the oven for any damage such as dents or broken door. Do not install if oven is damaged.

Countertop

Cabinet: Remove any protective film found on the cabinet surface.

Do not remove the light brown Mica cover that is screwed to the oven cavity to protect the magnetron.

Installation

1. Select a level surface that provide enough open space for the intake and/or outlet vents.

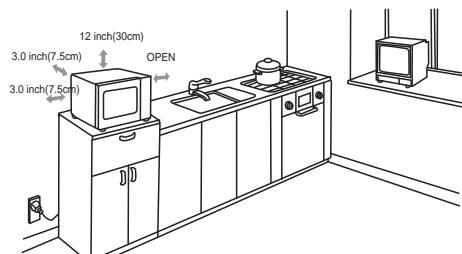

A minimum clearance of 3.0 inch (7.5cm) is required between the oven and any adjacent wall. One side must be open.

- (1) Leave a minimum clearance of 12inch (30cm) above the oven.

- (2) Do not remove the legs from the bottom of the oven.
- (3) Blocking the intake and/or outlet openings can damage the oven.
- (4) Place the oven as far away from radios and TV as possible. Operation of microwave oven may cause interference to your radio or TV reception.

2. Plug your oven into a standard household outlet. Be sure the voltage and the frequency is the same as the voltage and the frequency on the rating label.

WARNING: Do not install oven over a range cooktop or other heat-producing appliance. If installed could be damaged and the warranty would be void.

OPERATION

Control Panel and Features

Display Window

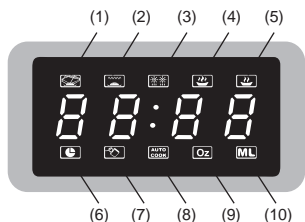

- (1). Microwave;
- (2). Grill;
- (3). Defrost;
- (4). High power;
- (5). Low power;
- (6). Time;
- (7). Lock function for children;
- (8). Auto cook;
- (9). Ounce;
- (10). Millilitre;

Control Panel

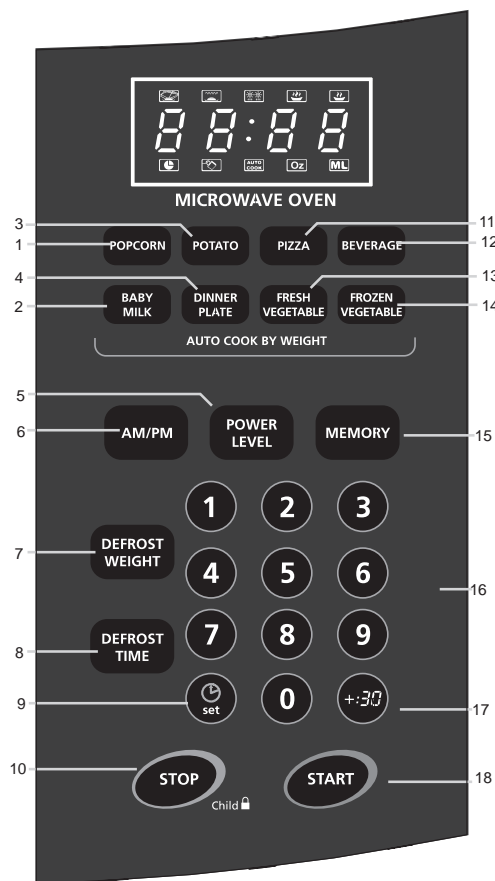

- 1 POPCORN
- 2 BABY MILK
- 3 POTATO
- 4 DINNER PLATE
- 5 POWER
- 6 AM/PM
- 7 DEFROST W.T.
- 8 TIME DEFROST
- 9 CLOCK:setting time
- 10 STOP: clears all previous settings if pressed before cooking starts.
During cooking,press once to stop oven, twice to stop and clear all entries.
- 11 PIZZA
- 12 BEVERAGE
- 13 FRESH VEGETABLE
- 14 FROZEN VEGETABLE
- 15 MEMORY
- 16 NUMBER KEYS
- 17 +:30SEC.
- 18 START

Operation Instructions

1. Power Level

Ten power levels are available, life cycle T=22 seeds

Level	10	9	8	7	6	5	4	3	2	1
Power	100%	90%	80%	70%	60%	50%	40%	30%	20%	10%

Remarks: When a power level between 10-8 is chosen, the high level indicator lights up and will flash when in operation.

When a power level between 7- 1 is chosen, the low level indicator lights up and will flash when in operation.

2. Clock Setting

When the microwave oven is plugged into an outlet, the oven will display " 0:00 "

- (1) Press "**CLOCK**", LED will display 00:00, clock indicator will light. The hour figures will flash; ":" and "0" will be light.
- (2) Press the number keys and enter the correct time. For example, time is 10:12 now, please press "1,0,1,2" in turn.
- (3) Press "**AM/PM**" to choose AM or PM. AM or PM will be selected in turn by pressing the button " AM/PM " continuously.
- (4) Press "**CLOCK**" to finish clock setting, the clock indicator will go out. ":" will be flashing and the clock setting will be displayed.
- (5) If the numbers entered are not within the range of 1:00--12:59, the setting will be invalid until valid numbers are entered.



Note: In the process of clock setting, if the "**STOP**" button is pressed or if there is no operation within 1 minute, the oven will go back to the former setting automatically.

3. One stage of microwave cook

- (1) Keep on pressing "**POWER**" to choose microwave power. "MICRO" and "POWER" will be light together.
- (2) Press numerical pads to enter the cooking time; the maximum cooking time is 99 minutes and 99 seconds.
- (3) Press "**START**" to start cooking, the remaining cooking time will be displayed. ":", "MICRO", "POWER" indicators will be flashing.



4. Two stage of microwave cook

- (1) Keep on pressing "**POWER**" to choose power level 1, "MICRO" and "POWER" will be light together.
- (2) Press numerical pads to enter the time for the first cooking. The maximum cooking time is 99 minutes and 99 seconds.
- (3) Keep on pressing "**POWER**" to choose power level 2, "MICRO" and "POWER" will be light together.

- (4) Press numerical pads to input the second cooking time, the maximum cooking time is 99 minutes and 99 seconds.
- (5) Press "**START**" to start cooking, the remaining cooking time will be displayed; ":", "MICRO", "POWER" indicators will be flashing.
- (6) One "beep" will be sound when the first cooking ends, and then the second cooking will begin

5. Fast Starting

- (1) In waiting state, instant cooking at 100% power level can be started by selecting a cooking time from 1 to five minutes by pressing corresponding numerical pad. Press "**+30SEC**" to increase the cooking time; the maximum cooking time is 99 minutes and 99 seconds.
- (2) In waiting state, instant cooling at 100% power level with 30 seconds' cooking time can be started by pressing "**+30SEC**". Each press on the same button will increase cooking time by 30 seconds. the maximum cooking time is 99 minutes and 99 seconds.

Note: Each press on "+30SEC." can increase cooking by 30 seconds for the micro and Auto menu cooking. However, the operation will not work under "Auto Defrost" operation.

6. Defrosting WT Function

- (1) Press "**DEFROST W.T.**", LED will display "dEF1"; when at the same time "MICRO", "DEFROST" indicators will be light. 
- (2) Press numerical pad to input weight to be defrosted. " Oz " indicator will be light. Input the weight ranged between 4~100 Oz.
- (3) If the weight entered is not within 4~100, the input will be invalid. A "beep" will be sound and the microwave will not work until valid numbers are input .
- (4) Press "**START**" to start defrosting, the remained cooking time will be displayed. ":", "MICRO" and "DEFROSTING" indicators will be flash and the " Oz " indicator will go out.



7. TIME DEFROST Function

- (1) Press "**TIME DEFROST**", LED will display "dEF2". At the same time, "MICRO", "DEFROST" indicators will be light. 
- (2) Press numerical pads to enter defrosting time. The effective time range is 00:01~99:99
- (3) If the time entered is not within 00:01~99:99, the microwave will not work until valid numbers are input.
- (4) The default microwave power is power level 3. If you want to change the power level, press "**POWER**" once, and the LED will display "PL 3", then press the numerical pad of the power level wanted.
- (5) Press "**START**" to start defrosting. The remained cooking time will be displayed. ":", "MICRO" and "DEFROSTING" indicators will be flash.

8. POPCORN

Do not use this instant key if your popcorn bag size is less than 1.75 Oz (about 50 gram).

Press "POPCORN" twice , "MICRO"•"AUTO COOK" and "Oz" are flashing. "3.5" appears in the display.

Times (Press " Popcorn ")	Weight	Display
Once	1.75 Oz	
Twice	3.5 Oz	

** The cooking time for popcorn is for reference only . The setting can be adjusted according to various weights and types to meet individual taste needs.After cooking time is set. Listen carefully. Press START and STOP cooking when the time between pops 2-3 seconds.

9. POTATO

a) Press "POTATO" repeatedly until the number you wish appears in the display, "MICRO"•"AUTO COOK" and "Oz" lights.



"1"SET: 6.0 oz food (approximate 170 gram)

"2"SET: 12.0 oz food (approximate 340 gram)

"3"SET: 18.0 oz food (approximate 510 gram)

For example, press "POTATO" once : "6.0" appears in the display.



b) Press "START" to cook, "MICRO"•"AUTO COOK" is flashing, time counts down, beep tone sounds five times after cooking.

Times (Press "Potato")	Weight	Display
Once	1 set	
Twice	2 set	
Thrice	3 set	

10. PIZZA

a) Press "PIZZA" repeatedly until the number you wish appears in the display, "MICRO"•"AUTO COOK" and "Oz" lights.

You can reheat 1~3 slices of Pizza each time (approximate 85 gram).

Times (Press "Pizza")	Weight	Display
Once	1 Slice	
Twice	2 Slices	
Thrice	3 Slices	

For example, press "PIZZA" twice, " 12.0 " appears in the display.

b) Press "Start" to cook, "MICRO"•"AUTO COOK" is flashing, time counts down, beep tone sound five times after cooking.

11. BEVERAGE



- a) Press "BEVERAGE " repeatedly until the number you wish appears in the display, "MICRO" • "AUTO COOK " • "ML" lights.

You can reheat 1~3 cups of beverage each time (approximate 250 gram).

For example, press "Beverage" twice,

" 2 " appears in the display. (CUPS)

- b) Press "START" to cook, "Cups" disappears, "MICRO"•"AUTO COOK" is flashing, time counts down, beep tone sounds five times after cooking.

Times (Press "BEVERAGE")	Weight	Display
Once	1 M u g	
Twice	2Mugs	
Thrice	3Mugs	



12. BABY MILK

- a) Press "BABY MILK " repeatedly until the number you wish appears in the display, "MICRO"•"AUTO COOK"•"ML" lights.

You can reheat 1~3 cups of beverage each time .

For example, press "BABY MILK" twice, "150" appears in the display.

- b) Press "START" to cook, "Cups" disappears, "Stage 1" is flashing, time counts down, beep tone sounds five times after cooking.



Times (Press "BABY MILK")	Weight	Display
Once	1 M u g	
Twice	2 Mugs	
Thrice	3 Mugs	

13. DINNER PLATE

- a) Press "DINNER PLATE" repeatedly until the number you wish appears in the display, "MICRO"•"AUTO COOK" and "OZ" lights.



For example, press"DINNER PLATE" twice, "12.0" appears in the display.

- b) Press "START" to cook, "MICRO"•"AUTO COOK" is flashing, time counts down , beep tone sound five times after cooking.

Times (Press "DINNER PLATE")	Weight	Display
Once	1 Set	
Twice	2 Set	
Thrice	3 Set	



14. FRESH VEGETABLE

- a) Press "FRESH VEGETABLE" repeatedly until the number you wish appears in the display, "MICRO"•"AUTO COOK" and "Oz" lights.
 "1" SET: 6.0 oz food (approximate 170 gram)
 "2" SET: 12.0 oz food (approximate 340 gram)
 "3" SET: 18.0 oz food (approximate 510 gram)
 For example, press "FRESH VEGETABLE" twice, "12.0" appears in the display.
- b) Press "START" to cook, "Oz" disappears, "MICRO"•"AUTO COOK" is flashing, time counts down, beep tone sound five times after cooking.

Times (Press "FRESH VEGETABLE")	Weight	Display
Once	1 Set	
Twice	2 Set	
Thrice	3 Set	

15. FROZEN VEGETABLE

- a) Press "FROZEN VEGETABLE" repeatedly until the number you wish appears in the display, "MICRO"•"AUTO COOK" and "Oz" lights.
 "1" SET: 6.0 oz food (approximate 170 gram)
 "2" SET: 12.0 oz food (approximate 340 gram)
 "3" SET: 18.0 oz food (approximate 510 gram)
 For example, press "FROZEN VEGETABLE" twice, "12.0" appears in the display.
- b) Press "START" to cook, "Oz" disappears, "MICRO"•"AUTO COOK" is flashing, time counts down, beep tone sound five times after cooking.

Times (Press "FROZEN VEGETABLE")	Weight	Display
Once	1 Set	
Twice	2 Set	
Thrice	3 Set	

16. MEMORY Function

- (1) Press "**MEMORY**" for one to five times to save any program set other than the default pre-set ones. The LED will display "1" to "5" which is corresponding to the specific program saved.
- (2) When a cooking program has been set, press "**START**" to save the program by using the set memory from 1 to 5. Two power cooking program can also be set the same way as setting COOKING BY TIME. The set cooking program will be saved by pressing "**MEMORY**" The oven will then turn back to the waiting state. By pressing "**START**" the set program saved will be operated at once.
- Note: Memory cooking can be used as cooking programs in pre-set cooking. If in the

process of pre-setting, memory cooking programs is set at the same time, only cooking programs can be recorded and the pre-set time will not be recorded.

17. Pre-set Function

- (1) Set a certain cooking procedure(one block or two),the setting method and display is same as relevant cooking procedure.(Defrosting is beyond pre-set cooking).
- (2) Press "**CLOCK**" to display the current clock, "clock" indicator will light the higher hour indicator will be flashing, ":" and other "0" 's will light.
- (3) Press the numerical pads to input higher hour, the lower hour will flash;
- (4) Press the numerical pads to input lower hour, the higher minutes will flash;
- (5) Press the numerical pads to input higher minutes, the lower minutes will flash;
- (6) Press the numerical pads to input lower minutes, and press "**START**" to confirm the pre-set cooking. The oven will then turn back to the clock displaying state, and the clock indicator ":" will flash.
- (7) When the pre-set time is reached, two "beep" will sound denoting the beginning of the cooking.

Note: The clock must be set before the pre-set cooking. If the cooking program has not been saved and only the pre-set time have been programmed, the oven can only be used as an alarm clock and five "beep" will be sound when the pre-set time is reached.

18. Inquiring Function

- (1) In clock state, press "**AM/PM**" to display "AM/PM" for 3 seconds.
In cooking state, press "**CLOCK**", the LED will display clock for three seconds and the "AM/PM" for another 3 seconds.
- (2) In pre-set state, the LED will display the clock and the seconds will be flashing at the same time. Press "**AM/PM**" and "AM/PM" will be displayed for 3 seconds. Then press "**CLOCK**" to inquire the pre-set time. The pre-set time will be flashing for 3 seconds, then "AM/PM" will be displayed for another 3 seconds. After that, the oven will turn back to the clock state.
- (3) In the level 1 cooking state, press "**POWER**" to inquire microwave power level, and the current microwave power will be displayed. After three seconds, the oven will turn back to the previous state.
- (4) In the level 2 cooking state, the inquiring way can be done by the same way as above.

19. Child Safety Lock Function

Lock: In waiting state, press "**STOP**" for 3 seconds, there will be a long "beep" denoting the entering into the children-lock state; meanwhile, LED will display ""

Lock quitting: In locked state, press "STOP" for 3 seconds, there will be a long "beep" denoting that lock is released.

20. Cooking End Reminding Function

When cook ends, there will be 5 "beep" to remind the completion.

21. Other Specifications

- (1) In waiting state , LED will display clock and ":" will not flash.
- (2) In function setting state, LED will display the related setting.
- (3) In operation and suspending state, LED will display the residual cooking time.
- (4) In operation or suspending state or when the door is open, the flashing "Micro" indicator will light the "restarting" will flash.
- (5) Other details can be found in the sample.

Trouble shooting

Normal	
Microwave oven interfering TV reception	Radio and TV reception may be interfered when microwave oven is in operation. It is similar to the interference of small electrical appliances , like mixer , vacuum cleaner,and electric fan. This is normal.
Dim oven light	In low power microwave cooking , oven light may become dim . This is normal.
Steam accumulating on door, hot air out of vents	In cooking , seam may come out of food . Most will come out from vents . But some may accumulate on cool place like oven door . This is normal.
Oven started accidentally with no food in .	It does no damage to oven if it operates empty for quite short time . But it should be avoided.

Trouble	Possible Cause	Remedy
Oven can not be started.	(1) Power cord not plugged in tightly.	Unplug. Then plug again after 10 seconds.
	(2) Fuse blowing or circuit breaker works.	Replace fuse or reset circuit breaker (repaired by professional personnel of our company)
	(3) Trouble with outlet.	Test outlet with other electrical appliances.
Glass turntable makes noise when microwave oven operates	(5) Dirty roller rest and oven bottom.	Refer to "Maintenance of Microwave" to clean dirty parts.

This appliance conforms with the FCC directives for radio interference suppression and low-voltage safety and has been built to meet current safety requirements.
Subject to technical changes without prior notice.

NOTE

1. Before commissioning this oven please read this instruction manual and keep it carefully.
2. There must be more than 30cm high space necessary above the top surface of oven.
3. Do not repair the oven yourself, please consult an authorized expert.
4. The contents of feeding bottles and baby food jars are to be stirred or shaken and the temperature is to be checked before consumption, in order to avoid burns.
5. Check the oven and the cable regularly for damage. If there is any kind of damage, the oven should not be used.

Warning: 1. It is hazardous for anyone other than a trained person to carry out any service or repair operation, which involves the removal of any cover which gives protection against exposure to microwave energy;

2. Only allow children to use the oven without supervision when adequate instructions have been given so that the children is able to use the oven in a safe way and understands the hazards of improper use.
3. If the supply cord is damaged, it must be replaced by the manufacture or its service agent or a similarly qualified person in order to avoid a hazard.

Do not attempt to operate this oven with the door open since open-door operation can result in harmful exposure to microwave energy. It is important not to defeat or tamper with the safety interlocks.

Carefully clean door seals and sealing surfaces

Do not operate the oven if it is damaged. It is particularly important that the oven door close properly and that there is no damage to the : (1) door (bent), (2) hinges and latches (broken or loosened), (3) door seals and sealing surfaces.

Utensils should be checked to ensure that they are suitable for use in microwave ovens.

When heating food in plastic or paper containers, check the oven frequently due to the possibility of ignition.

Microwave heating of beverages can result in delayed eruptive boiling, therefore care has to be taken when handling the container.

If smoke is observed, switch off or unplug the appliance and keep the door closed in order to stifle any flames.

Eggs in their shell and whole hard-boiled eggs shall not be heated in microwave ovens since they may explode.

If the door or door seals are damaged, the oven must not be operated until it has been repaired by a trained person.

Liquids or other foods must not be heated in sealed containers since they are liable to explode.

© 2005 Sunbeam Products, Inc. All rights reserved.

Sunbeam® is a registered trademark of Sunbeam Products, Inc. used under license.

Manufactured for Curtis International Ltd.

315 Attwell Drive, Etobicoke, Ontario M9W 5C1, Canada

For service call: 1-800-968-9853