

# Little Sea-ox

Haier Household Electric Water Heater

User's Manual

# Haier

FCD-JTSA50-III  
FCD-JTSA60-III  
FCD-JTSA70-III

## Haier Group

Qingdao Economic and Technological Development District

Haier Water Heater Co., Ltd.

Haier Garden, Qianwangang Road, Economic Development Zone, Qingdao, P. R. China

Website: <http://www.haier.com>

Rev. 01  
Specific Number 0040501637

- Please read this manual before usage
- Retain it for future reference

Haier

## Contents

### Before Usage

Features .....	2
Parameters .....	3
Dimension .....	3
Electric circuit diagram .....	3
Safety precautions .....	4
Setting environment .....	5

### Installation

Installation .....	6
Attentions in installation .....	7
Usage .....	8
Cleaning and maintenance .....	8

### FAQ \* After service

FAQ .....	9
Packing list .....	9
Note .....	10

● See to the physical product for the appearance, color or pattern.

## Note



Correct Disposal of this product:

This marking indicates that this product should not be disposed with other household wastes throughout the EU. To prevent possible harm to the environment or human health from uncontrolled waste disposal, recycle it responsibly to promote the sustainable reuse of material resources. To return your used device, please use the return and collection systems or contact the retailer where the product was purchased. They can take this product for environmental safe recycling.

## FAQ

Phenomenon		Please check	How to solve
No water output		Is water supply failed or water pressure too low?	Make check
		Is water exit blocked? Is hot water valve opened?	Check and clear
Cold water output only	Heating indicator is on	Heater breakdown	Contact the maintenance
	Heating indicator is off	Is the power switched on?	Switch on the power
		Is there temperature regulator breakdown?	Contact the maintenance
The heating indicator keeps on		The set water temperature is not reached yet	Continue heating
		Is there temperature regulator breakdown?	Contact the maintenance
Unstable quantity and temperature with water output		Is the tap water input pressure stable?	Make check

## Packing List

Name	Electric water heater	Safety valve	User's manual	Expansion bolt	Expansion hook	Drain hose
Quantity	1	1	1	2	2	1

## Before Usage

Dear users,

Thanks for choosing Haier water heater product.

Haier products have good quality and excellent performance. To facilitate you to use the product, please read the manual and operate accordingly. Please retain it for future reference.

The international star service of Haier Group will always accompany you. No matter what kind of problems you meet in usage, please contact with the local after-sales service agent. We are at your service all the time. Thanks again for choosing Haier Product.

The water heater you purchased may not full comply with the manual due to the improvement of product. We apologize for the inconvenience occurred therefrom.

## Features

### 1. Safety:

High-quality heat proof stainless steel electric heating element, overtemperature protection; overpressure protection of tank; safe and reliable; The 3rd generation "PTO I 0" technology, safer for usage.

### 2. Durability:

The shell adopts dusting anticorrosion treatment, handsome and durable enamel tank, with reliable quality and long operation life.

### 3. Convenience:

Adjustable heating temperature, adjustable water temperature.

Adjusting range: water inlet temperature ~75°C.

### 4. Multiple usage:

Enclosed structure, capable of supplying water to multiple places like toilet, kitchen etc. Suitable for family, enterprises, service trades like beauty care on hot water supply (not drinkable).

### 5. Nice molding, space-saving

Vertical type wall-mounting design, saving space.

The water heater you purchased is the improved model of the series product. Please operate according to the user's manual.

## Parameters

Rated voltage: 230V~,50Hz  
 Power: 1650W  
 Rated pressure: 0.75MPa  
 Waterproof grade: IPX 4(▲)

Dimension: (See to Figure 1)  
 Weight: (See to Figure 1)  
 Volume: (See to Figure 1)  
 Tap water pressure: no less than 0.05MPa

## Dimension

(Figure 1)

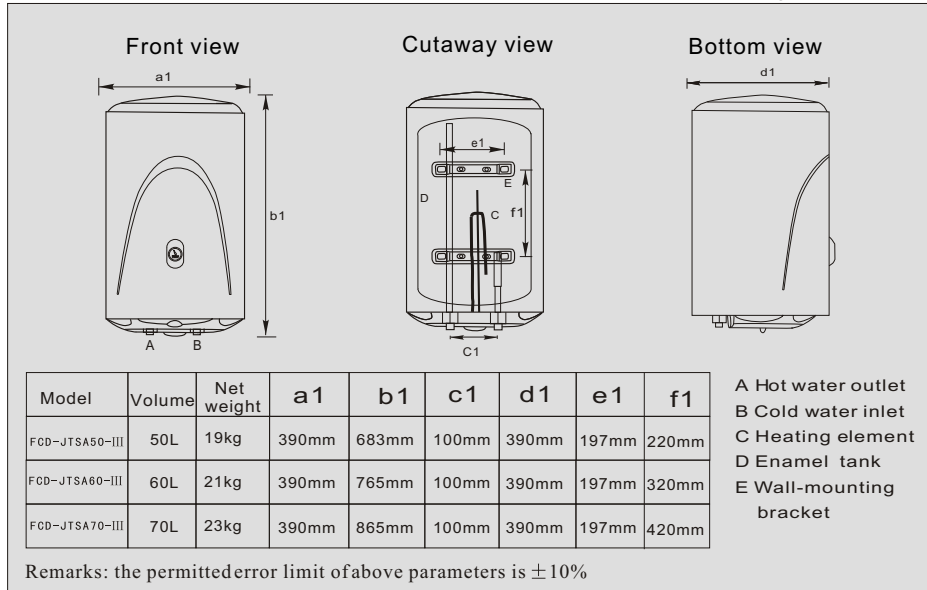

## Electric Circuit Diagram

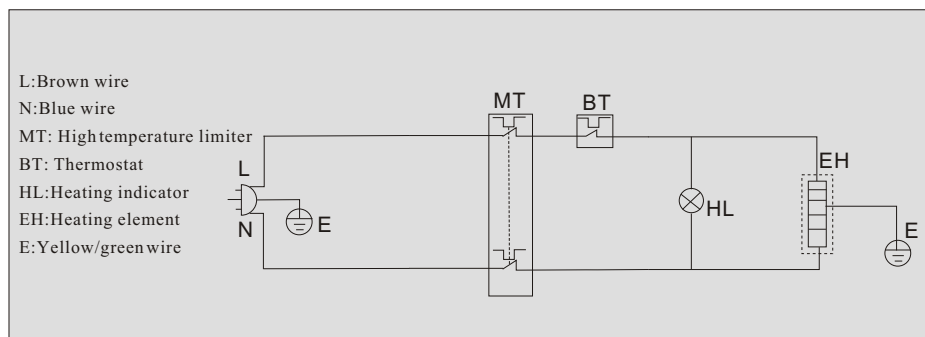

## Usage

- After installation, as the tank is empty in the first usage, be sure to open the faucet water inlet valve and mixing valve. When the tank is filled with water, and the shower nozzle or other water outlet keeps water outputting, please close the mixing valve, check if there's water leakage at each joint, and plug the power plug.
- Turn the knob as per the needed water temperature. The mark of knob increases from water inlet temperature to 75°C. You can set heating temperature steplessly. The heating indicator will light on under heating mode. Generally the knob should be set to the highest scale. The water heater can regulate the temperature automatically. The power will be switched off automatically when the set temperature is reached, and will be switched on automatically when the temperature drops to certain level. As it continues heating, you can use hot water as well.
- When the tap water inlet pressure arrives or exceeds 0.75 Mpa, the drain hose of safety valve will discharge large amount of water. It is due to extra high water pressure. Please contact the local after service for disposal.

## Cleaning and Maintenance

Be sure to switch off the power supply before cleaning. Use humid cloth with neutral detergent to wipe the shell gently. Do not use petrol and other solvent. Finally wipe it with dry cloth and keep the shell dry.

To guarantee the high-efficiency operating of the water heater, please clean the electric heating pipe and inner tank every three years. Do not damage the protection coating outside the electric heating element and inside the inner tank. The Magnesium anode rod shall also be replaced periodically according to the local water quality. Please contact the local maintenance department for maintenance service.

## Installation

- The water may drip from the discharge pipe of the pressure relief device and that this pipe must be installed in a continuously downward direction and in a frost-free environment. Check safety valve once a month as follow: move the small handle of safety valve, if there's water flowing out, safety valve is normal; if there's no water flow, please contact local after-sales service station.
- The pressure relief device is to be operated regularly to remove lime deposits and to verify that it is not blocked.

## Attentions in Installation

- Please fasten the drain hose to the drain thread of safety valve by twisting (see to Figure 3). Connect the other end of drain hose to the sewer to avoid polluting the room by splashing. When the power is switched on, and the water heater starts operating, there may be some water discharged from the pressure relief hole of safety valve. It is due to the water expansion under heating, and is normal phenomenon. The pressure relief pipe shall communicate with the air directly. Do not block it. The discharged water can be led to the sewer.
- Select suitable position on the wall to fix the shower nozzle bearer. Connect the shower nozzle hose to the pipeline. Fasten the mixing valve. Check if there's water leakage at each joint.
- Be sure to check and confirm that the tank is filled with water, there's no leakage at each joint and the power supply complies with the stipulation before switching on the power.

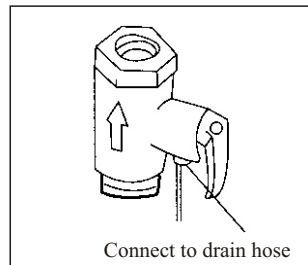





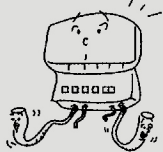
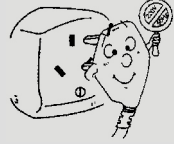

(Figure 3)

**Safety precaution:** Do not confuse the water inlet and outlet pipe. The wall bearing the water heater shall be strong enough to endure a weight twice as much as that of water heater filled with water.

If any part is damaged, please contact the local maintenance agent, and have it replaced with our spare part.

## Safety Precautions

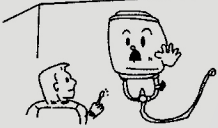

 <ul style="list-style-type: none"> <li>● Check if the ammeter and the diameter of the wires are in accordance with the rated current of the water heater. If necessary please have it checked by experienced electrician.</li> </ul>	 <ul style="list-style-type: none"> <li>● The water heater adopts power supply of 230V~,50Hz.</li> </ul>
 <ul style="list-style-type: none"> <li>● Be sure to use independent receptacle and earth it reliably. The receptacle shall comply with the stipulation of national standard.</li> </ul>	 <ul style="list-style-type: none"> <li>● Set the receptacle of the water heater at dry position away from water spraying. Do not insert and pull the power plug with wet hands.</li> </ul>
 <ul style="list-style-type: none"> <li>● After installation, be sure to fill the heater completely with water before switching on the power in the first usage. Children must take bath under the supervision of adult.</li> </ul>	 <ul style="list-style-type: none"> <li>● In opening and closing the water valve, do not point the shower head to human body. Otherwise it may hurt by the spraying hot water.</li> </ul>
 <ul style="list-style-type: none"> <li>● In winter of cold area, if the heater is idle for a long period, please pull the handle of safety valve to discharge the water. Otherwise it may freeze inside the water heater and cause damages.</li> </ul>	 <ul style="list-style-type: none"> <li>● In case the power cord of the water heater is damaged, be sure to have it replaced by after service technicians with special cord offered by the manufacturer.</li> </ul>
<p>The product adopts the patent "PTO I 0" technology of our company. As long as adopting civil power supply, even if the earthing wire is electrified by mistake, the "PTO I 0" technology still can block the dangerous electricity, and ensure your personal safety. But if you find perceptible current, please pull off the power plug and contact local after service department for maintenance. Do not disassemble by yourself.</p>	
<h3>Description of the Symbols</h3>	
<ul style="list-style-type: none"> <li>⊘ Never do that</li> <li>⚠ Be sure to act as per instructions</li> </ul>	

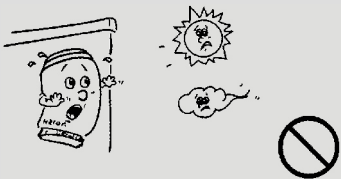
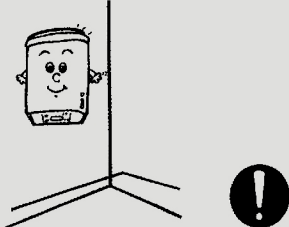
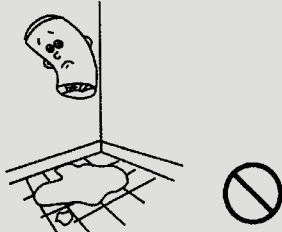
## Setting Environment

 <p>Do not set it at place where is too cold and may freeze.</p>	 <p>Do not set at outdoor places.</p>
 <p>Do not use as floorstanding appliance.</p>	 <p>Please mount it to firm and reliable wall.</p>
 <p>Do not install to places without sewer.</p>	 <p>In case connecting water heater with water drain hose, connect the drain hose to the inlet of the sewer to avoid polluting by splashing.</p>

The original pipeline of the water heater is an organic part of "PTO I 0". Do not remove it by yourself. Otherwise we will not take responsibility for the injure and loss caused by the safety trouble occurred therefrom.

### Description of the Symbols

-  Never do that
-  Be sure to act as per instructions

## Installation

- Be sure to have it installed by installation staff of the after service department, or the appointed staff. It adopts wall-mounting installation.
- Make four holes with diameter of 12mm and depth 65mm with churn drill on the wall as per the installation dimension drawing. Insert the bolts into the holes. Then lift the water heater, set the wall-mounting rack on the bolt. Set the gasket and fasten the nut. Install the accessories including safety valve etc. as indicated in Figure 2. Remember to seal with rubber tape to avoid water leakage.
- To facilitate the installation and dismantling, it is suggested to add G 1/2' flexible nut at the suitable position of the water inlet and outlet pipe separately. Confirm the position needing water supply. Connect the water inlet/outlet pipe and tap water pipe to the position respectively. The hot water pipe shall not be too long to reduce the heat losses. Please reserve some space in installation for the future maintenance.

(Figure 2) for reference in installation only

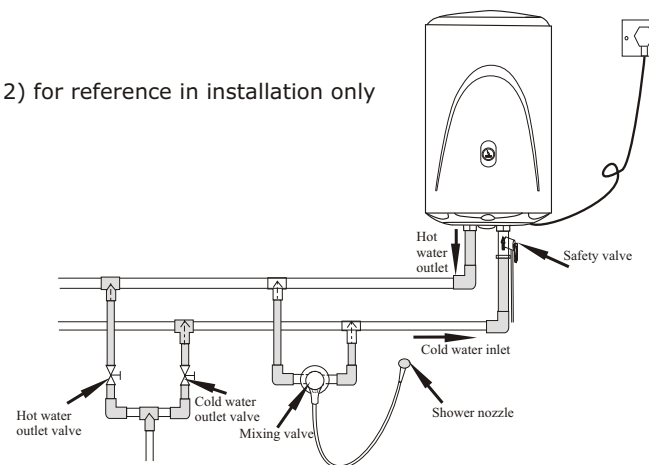

- Connection and use of safety valve:
  - The safety valve should be connected to the cold water inlet pipe. Please check carefully if the direction is correct after installation. The correct direction of installation is that the arrowhead on the safety valve should point to the water heater.
  - Please connect the drain hose to the safety valve. Connect one end of the hose to the safety valve vent and the other end to the sewage drain. The hose can be cut short or extended as necessary. The hose shall be installed as inclined downward.