

# TAMRON®

## SP 70-300mm F/4-5.6

Di VC USD for Canon and Nikon (Model A005)

## SP 70-300mm F/4-5.6

Di USD for Sony (Model A005)

Thank you for purchasing the Tamron lens as the latest addition to your photographic equipment. Before using your new lens, please read the contents of this Owner's Manual thoroughly to familiarize yourself with your lens and the proper photographing techniques for creating the highest quality images possible. With proper handling and care, your Tamron lens will give you many years of photographing beautiful and exciting pictures.

### NOMENCLATURE (Refer to Fig. 1, if not specified)

1. Lens hood
2. Hood attaching alignment mark
3. Hood attaching indicator
4. Filter ring
5. Hood attaching index mark
6. Zooming ring
7. Focal length scale
8. Zoom index mark
9. Focusing ring
10. Distance scale
11. Distance index
12. VC (Vibration Compensation) switch
13. AF/MF switch (Fig. 3 & 4)
14. Lens attachment mark
15. Lens mount/Lens mount contacts

### SPECIFICATIONS

	<b>A005</b>
Focal Length	70-300mm
Maximum Aperture	F/4-5.6
Angle of View	34° 21' - 8° 15'
Lens Construction	12/17
Minimum Focus Distance	1.5 m
Maximum Magnification Ratio	1:4.03
Filter Size	62 mm
Length	142.7 mm
Diameter	81.5 mm
Weight	765 g
Lens Hood	HA005

\* Lengths, diameters and weights listed are of lenses with Nikon mounts.

1

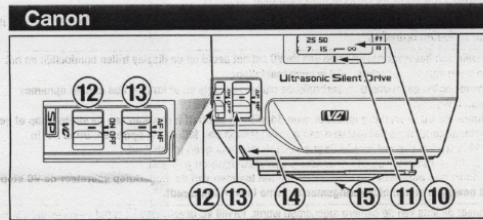
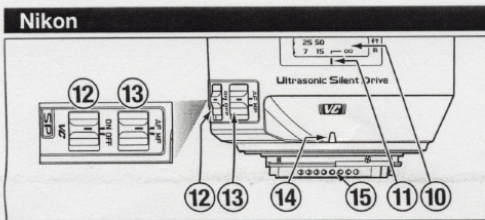
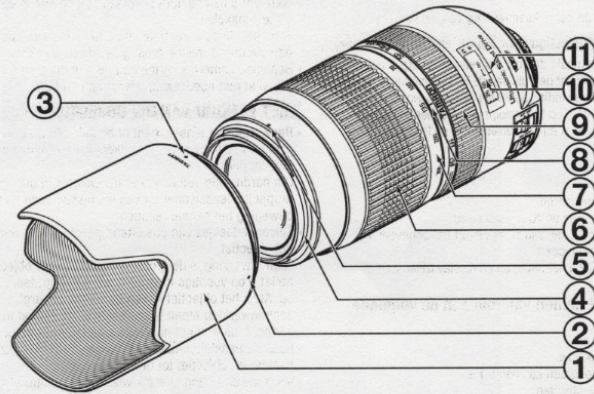

\* A005: This model is Built-in Motor / A005: 内置电动机

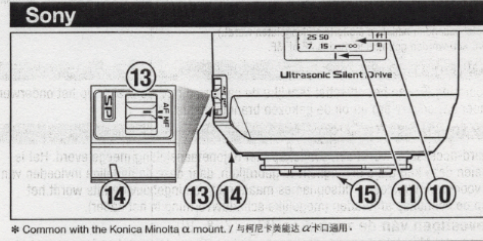

\* Common with the Konica Minolta  $\alpha$  mount. / 与柯尼卡美能达  $\alpha$  卡口通用。

2

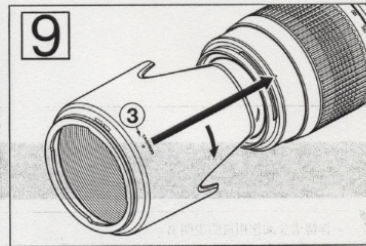
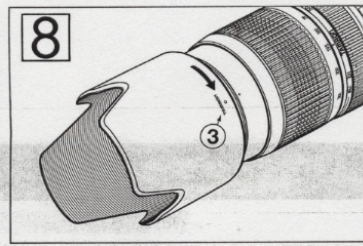
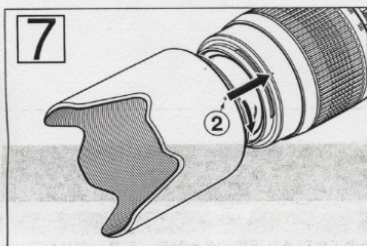
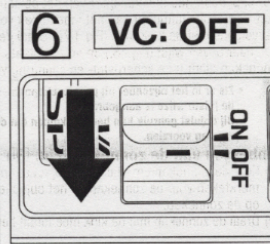
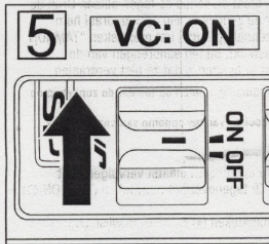
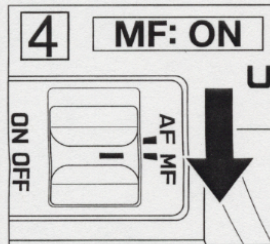
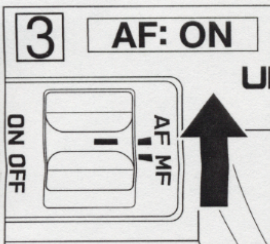
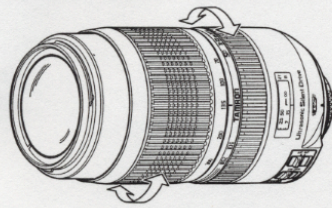

CE

\* The CE Marking is a directive conformity mark of the European Community (EC).  
 \* Das CE-Zeichen entspricht der EC Norm.  
 \* La marquage CE est un marquage de conformité à la directive CEE (CE).  
 \* La marca CE es marca de conformidad según directiva de la Comunidad Europea (CE).  
 \* Il marchio CE attesta la conformità alla direttiva della Comunità Europea (CEE).  
 \* CE 标志表示符合欧洲共同体 (EC) 指标

CE

The EEC Conformity Report applies to the Council Directive 98/336/EEC, 92/31/EEC, 93/68/EEC and is used by Tamron Co., Ltd., manufacturer of this product.

## **ATTACHING AND REMOVING THE LENS**

### *\* How to mount the lens*

Remove the rear cap of the lens. Align the lens attachment mark (14) on the lens barrel with its counterpart on the camera mount and insert the lens. For Nikon models, align the lens attachment mark with the dot on the camera and rotate the lens counter-clockwise until it click-locks.

### *\* How to detach the lens*

Press the lens release button on the camera down, turn the lens counter-clockwise (Nikon turn clockwise), and lift the lens off the camera's lens mount.

\*For further details, please read the instruction manual of your camera.

## **FOCUSING (AUTOFOCUS) and using the full-time manual function**

In case of Sony cameras, switch the focusing mode switch of the camera to Auto focusing mode (AF). In case of Canon or Nikon camera, switch the AF/MF switch (13) on the lens to AF (Fig. 3). In case of Nikon camera with the focus mode selector dial, set the focus mode to S or C, and then set the AF/MF switch on the lens side (13) to AF. Press the shutter button lightly while viewing through the camera's viewfinder, the lens focuses automatically. An in-focus mark will light when lens focuses on the main subject sharply. Press the shutter button further to photograph.

### **Using the full-time manual function?**

A005 is equipped with the full-time manual function.

The full-time manual function is a function that the focus can be fine-tuned by the manual focus without the AF/MF changing switch when taking a picture with autofocus.

#### *How to use the full-time manual function*

First, set the focus mode to AF. You can adjust focus manually while turning the focusing ring with the shutter button pressed lightly.

*\* When set on AF mode, interfering with the focusing ring may cause serious damage to the lens mechanism.*

*\* The distance scale is marked for guidance purposes. The actual focal point may slightly differ from the distance marked on the focal length index.*

\*For further details, please read the instruction manual of your camera.

## **FOCUSING (MANUAL FOCUS) (Ref. Fig. 1, 2 & 4)**

In case of Sony cameras, switch the focusing mode switch of the camera to manual focusing mode (MF). In case of a Nikon or Canon camera, switch the AF/MF switch (13) on the lens to MF (Fig. 4). In case of Nikon camera with the focus mode selector dial, set the focus mode to M and then set the AF/MF switch on the lens side (13) to MF. Focus manually by rotating the focusing ring (9) while viewing through the camera's viewfinder. The main subject in the viewfinder will be sharp when the lens is focused correctly.

\* Even when in MF mode, turning the focusing ring while pressing the shutter button halfway, the focus aid function lamp lights up when the picture is in focus.

\* At infinity, make sure the image in the viewfinder appears sharp. The infinity position is made with certain allowances to insure proper focus under a variety of conditions.

\* For further details, please read the instruction manual of your camera.

## **VC MECHANISM (Ref. Fig. 1, 5 & 6) (Mounted for Nikon and Canon models)**

VC (Vibration Compensation) is a mechanism that reduces the image blur caused by hand-held shooting. When using the VC, pictures can be taken at shutter speeds up to a maximum of 4 stops slower than the speed when the VC is not used.

\*Based on the company's standard measurement. Also, the correction of image blur differs depending on the conditions during picture taking and the person using the camera.

### *\* How to use VC mechanism*

VC can be used in AF or MF mode.

1. Set the VC switch on.

\*When VC is not used, set switch off.

2. Press the shutter button halfway to verify the effect of the VC. When the shutter button is pressed halfway, it takes about 1 second for the VC to provide a stable image.

With the VC mechanism, there are no occasions when the image in the viewfinder blurs after the shutter button is pressed down halfway.

### *\* The VC can be effective for hand-held shots under the following conditions:*

-Dimly lit locations

-Scenes where flash photography is forbidden

-Situations where footing is uncertain

-Taking continuous shots of moving subjects

### *\* The VC may not be able to give full effect in the following cases:*

-When a photograph is taken from a fast moving vehicle

-Shooting during the excessive movement of the camera

-Turn the VC switch OFF when taking pictures with the bulb setting or during long exposures. If the VC switch is ON, the VC mechanism may introduce errors.

*-With the VC mechanism, there are occasions that the image in the viewfinder blurs right after the shutter button is pressed down halfway, but this is not a malfunction.*

*-When the VC is ON, the number of images recordable is reduced due to the power used from the camera.*

*-When the VC is ON, immediately after the shutter button is pushed halfway down and approximately 2 seconds after a finger releases the shutter button, the camera will "click". This sound is the VC's locking mechanism activating, not malfunctioning.*

*-Turn the VC switch OFF when using a tripod.*

*-After releasing the shutter button, the VC will continue to operate for about 2 seconds until the locking mechanism activates.*

-When the lens is removed from the camera while VC is activating, the lens may make clicking sound when the lens is subjected to jolt. This is not a malfunction. Re-attach the lens to the camera and turn the power ON. The sound should stop.

-The VC activates while the "release" button is pushed halfway down. (It is activated 2 seconds after the shutter button is released.)

-VC can be used in AF or MF mode.

## **ZOOMING (Ref. Fig. 1 & 2)**

Rotate zooming ring (6) of the lens while viewing through the camera's viewfinder and compose your image at the chosen focal length.



## **LENS HOOD (Ref. Fig. 1, 7 & 9)**

A bayonet-type lens hood is provided as standard equipment. We recommend shooting with the hood attached whenever possible as the lens hood eliminates stray light, which is harmful to the picture. However, please be aware of the precautions stated in the next section when your camera is equipped with a built in flash.

### *Attaching the Lens Hood (Ref. Fig. 7 & 8)*

Align Hood attaching alignment mark (2) on the hood with the corresponding index mark (5) or the top of the index line of the distance scale of the lens. Press the hood lightly onto the hood attaching index mark (Fig. 7) and then rotate it clockwise to secure. The lens hood will be secure when the mark "TAMRON O" is at the top (Fig. 8). When attaching the lens hood, hold the focus and zoom control rings, so they are not rotated unintentionally.

*-Pay particular attention to align the hood attaching indexes when using zoom lenses including wide-angle setting. Improper attachment of a hood on a wide-angle zoom lens may cause large shadowed areas in your pictures.*

### *Stowing lens hood on the lens (Ref. Fig. 9)*

Reverse the lens hood. Point the lens toward the opening, and then align the hood attaching index on the lens with the "TAMRON O" alignment on the hood (3). Turn the hood clockwise until the alignment mark is at the top to set it (Fig. 9).

## **PRECAUTIONS IN SHOOTING**

-The optical design for Di takes into consideration the various features of digital single reflex cameras. However, due to the configuration of the digital single reflex cameras, even when auto focus accuracy is within specifications, the focal point may be a little forward or behind the optimum point when shooting with auto focus under some conditions.

-When the built-in-flash on the camera is used, adverse photographic phenomena such as corner illumination fall-off or vignetting at the bottom part of the image may be observed, especially in wide angle ranges. This is due to the inherent limitation of the coverage of the built-in-flash, and/or the relative position of the flash to the edge of the lens barrel which causes shadows on the image. It is strongly recommended to use a suitable separate flash unit provided by the camera manufacturer for all flash photography. For further details, please read the "built-in-flash" article on the instruction manual of your camera.

-When using the lens in the telephoto focal range, please be careful of camera shake. To reduce blur, turn the VC (Vibration Compensation) switch on. To reduce image blue without using the VC function, follow these steps.

To avoid camera shake on digital cameras, use higher ISO settings and for film cameras, use higher ISO film to obtain higher shutter speeds. Using a tripod or monopod is also effective.

When hand-holding the camera to take pictures, stand still opening your legs slightly apart, hold your elbows in firmly against your chest, and hold the camera firmly against your face. If possible, lean against something to steady yourself or place the camera on something to secure the hold. Especially when hand-holding your camera, you will be steadier if you hold your breath while you press the shutter button down gently and firmly.

-When set on AF mode, interfering with the focusing ring may cause serious damage to the lens mechanism.

-Certain models may indicate the maximum and minimum aperture values of the lens in approximate numbers. This is inherent to the design of the camera and not an indication of an error.

### **TO ENSURE LONG-TERM SATISFACTION**

-Avoid touching the glass element surface. Use photographic lens cloths or blowers to remove dust from the lens element surface. When not using the lens, always place a lens cap on it for protection.

-Use a lens cleaning tissue or lint cloth with a drop of cleaning solution to remove fingerprints or dirt on the glass lens surface with a rotary motion from the center to the edge. Use a silicone cloth to clean your lens barrel only.

-Mildew is an enemy of your lens. Clean the lens after shooting near water or in any humid place. Store your lens in a clean, cool, dry place. When storing the lens in a lens case, store it with commercially available drying agents such as silicagel, and change the agent occasionally. If you find mildew on your lens, consult an authorized repair shop or nearby photographic store.

-Do not touch the lens-camera interface contacts since dust, dirt and/or stains may cause a contact failure between the lens and camera.

-When using your equipment [camera(s) and lens(es)] in an environment where the temperature changes from one extreme to the other, make sure to put your equipment temporarily in a case or plastic bag for a length of time in order for the equipment to go through a gradual temperature shift. This will reduce potential equipment trouble.