

FHD2400 24-inch Widescreen LCD Monitor

USERGUIDE



Contents

Using Your Gateway Flat-Panel Monitor	1
Connecting the monitor	2
Attaching the stand	2
Connecting video inputs	2
Connecting USB cables	4
Setting up the optional speaker bar	5
Connecting power	7
Connecting a security cable	7
Adjusting the stand	8
Rotating the screen	8
Ergonomic guidelines	8
Starting the monitor	9
Turning on the monitor	9
Adjusting monitor settings	10
Using the EzTouch menu buttons	10
Using the shortcut menu	10
Using the main menu	12
Using Picture-in-Picture (PIP)	15
Changing Windows screen settings	16
Changing color depth and screen resolution	16
EzTune software	17
Using the speaker bar	18
Power management	18
Energy declaration	18
Maintaining	18
Troubleshooting	19
Troubleshooting symptoms	19
No power	19
No picture	19
Display colors are wrong	20
Picture has shadows or "ghosts"	20
Color is not uniform	20
Image is not sized or centered correctly	20
The monitor has pixels that are always dark or too bright	20
Speaker bar does not work	21
FAQs	22
General	22
How To	22
Technical	23
Video/Display	23
Specifications	24
Video modes	26
Safety, Regulatory, and Legal Notices	27

Using Your Gateway Flat-Panel Monitor

- [Connecting the monitor](#)
- [Adjusting the stand](#)
- [Starting the monitor](#)
- [Adjusting monitor settings](#)
- [Changing Windows screen settings](#)
- [Using the speaker bar](#)
- [Power management](#)
- [Maintaining](#)
- [Troubleshooting](#)
- [FAQs](#)
- [Specifications](#)

Connecting the monitor

To set up the monitor, first attach the base, then make your cable connections.

Attaching the stand

► **To attach the stand:**

- 1 Place the monitor face-down on a soft, non-marring surface. A non-slip mat on a tabletop is ideal.
- 2 Remove the four thumbscrews that are attached to the back of the monitor.



- 3 Lay the stand on the monitor so the thumbscrew holes line up with the holes in the stand.
- 4 Replace the thumbscrews.



- 5 Test the bracket connection to make sure it is secure, then place the monitor upright.

Connecting video inputs

► **To connect video sources to your monitor:**



Tip

Rotate the screen 90° to make it easier to connect the cables.

- 1 Position your computer and the monitor so you can reach the back of each.
- 2 Make sure that your computer is turned off.

- 3 If your computer has an HDMI digital audio/video connector, connect an HDMI cable to the HDMI connector under the back of the display.



Important

An HDMI cable has not been included with your monitor. A cable can be purchased from www.gateway.com (available in the U.S. only) or from various Internet retailers and electronic retail stores.

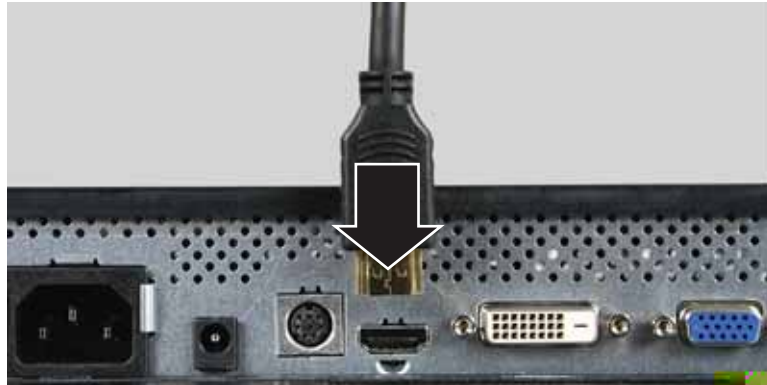

- OR -

- If your computer has a digital video connector (DVI), connect a DVI video cable to the white connector under the back of the display.



- OR -

- If your computer has only an analog VGA (blue) port, connect the VGA video cable to the VGA video connector under the back of the display.

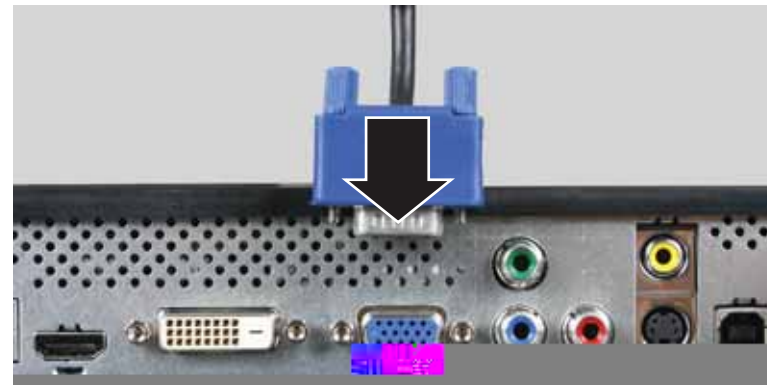

- 4 Connect the other end of the video cable to the matching video port on the back of your computer.

- 5 Connect other video sources (such as a DVD player, video camera, or receiver) to the appropriate video jacks on the back of the monitor.

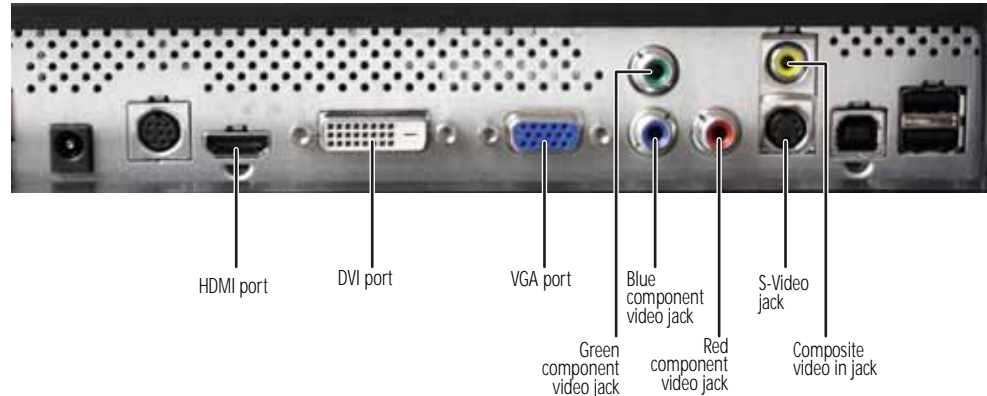

- For *basic* video quality, connect your video device's **composite video in** jack to the corresponding jack on the back of your monitor (cable not included).
 - For *better* video quality, connect your video device's **S-Video** jack to the corresponding jack on the back of your monitor (cable not included).
 - For *best* video quality, connect your video device's **component video (green Y, blue Pb, and red Pr)** or **HDMI** jacks to the corresponding jacks on the back of your monitor (cables not included).
- 6 Route the cables through the cable clip on the back of the stand. If you plan on using the screen in portrait mode, make sure you leave enough slack in the cables for screen rotation. ■

Connecting USB cables

Your monitor has a built-in, four-port USB 2.0 hub that lets you conveniently connect USB devices. Because your computer case may be under your desk or inside a cabinet, these monitor-mounted USB ports can be much easier to access.

To use the monitor's USB ports, you must first connect the monitor to a USB port on your computer. Because the USB hub uses power from the monitor, it does not require its own power connection.

► To connect USB cables:



Important

The built-in USB 2.0 hub provides only low-speed connections if its USB in port is connected to a USB 1.1 port on your computer or on a USB hub.



Tip

Use the USB 2.0 ports on the back of the monitor for connecting USB devices you want to keep connected most of the time, such as a keyboard, a mouse, or a printer. Use the USB 2.0 ports on the side of the monitor for connecting USB devices that are frequently disconnected, such as cameras, flash drives, and USB hard drives.

- 1 Connect the included USB cable to the **USB in** ("B" type) port on the back of your monitor, then connect the other end of the cable to a USB 2.0 port on your computer.



- 2 Connect any USB device to one of the available USB 2.0 ports on the left side or back of the monitor.



Setting up the optional speaker bar

An optional speaker bar is available for mounting underneath your monitor. You can order a speaker bar from www.gateway.com.

► **To install the speaker bar:**

- 1 Turn off the monitor.

✓ Important

If you connect the speaker bar to the monitor while the monitor is turned on, the speaker bar will not initialize and will not work correctly. If this happens, turn the monitor off, then back on to enable the speaker bar.

- 2 Tilt the screen back, then match the mounting clips on each side of the speaker bar with the mounting slots underneath the monitor.



- 3 Slide the speaker bar onto the bottom of the monitor until it snaps into place. Make sure that it is secure by pulling it downward.

- 4 Plug the speaker bar's power and audio plugs into the appropriate connectors underneath the monitor.



- 5 Plug the speaker bar's pink and green 3.5 audio plugs into the appropriate speaker and microphone connectors on the computer.

✓ Important

For best audio performance, if your video connection uses HDMI, the digital audio is also conveyed along the same cable, and no additional audio connection is required. You may need to set your video source's audio mode to **PCM** or **ANALOG** to hear the audio. See your source device's user guide for more information.

For information on using the speaker bar, see ["Using the speaker bar"](#) on page 18.

► **To remove the speaker bar:**

- 1 Disconnect all audio and power cables from the speaker bar.
- 2 Press the two clips on the back of your monitor, then slide the speaker bar back.



Connecting power

► **To connect power:**

- 1 Position your monitor so you can reach the back, then connect the power cord to the power connector under the back of the monitor.

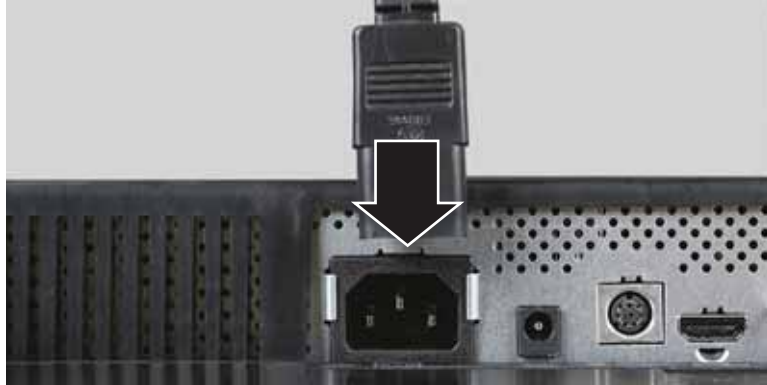

- 2 Plug the power cord into a correctly grounded power outlet. We recommend using a surge protector to protect your monitor from voltage spikes.
- 3 To make sure that the monitor's power is correctly connected, check the power button on the front button panel. The power icon on the power button should be glowing purple. If the power icon is not visible, power is not connected.



Connecting a security cable

You can secure your monitor to your computer desk (or to another heavy object) with a cable lock. To connect a cable lock, follow the cable lock's instructions to connect it to the Kensington lock slot on the back of your monitor (cable lock not included).



Adjusting the stand

Rotating the screen



Tip

To rotate the screen while the optional speaker bar is attached, first tilt the screen back for more clearance between the speaker bar and the tabletop.

You can rotate the screen clockwise 90° to change between landscape and portrait views. For information on automatically rotating the display image as you manually rotate the monitor, see [“Using landscape and portrait modes” on page 17](#).



Landscape mode



Portrait mode



Tip

For the brightest viewing angle, adjust the screen so that you are viewing it from within a 160° angle of the screen. When the display is rotated to portrait mode, the side-to-side viewing angle may be reduced.

Ergonomic guidelines

The recommended screen positioning is based upon the following guidelines. These guidelines are based on available scientific literature and published standards.

Screen height

The recommended screen height for displays (except in special circumstances, such as for bifocal use) is that the top of the display should be set at or slightly below (about 1 inch or 25 mm) your eye level while you are sitting in a comfortable working posture. This guideline places the center of the screen at an ideal 15° to 20° viewing angle for most desktop displays. If the display has multiple users, the screen height should be easily adjustable to accommodate each user's height and preference.

Screen tilt

The screen should be tilted so your line of sight is perpendicular to the screen. This angle creates the most consistent viewing distance when scanning from the top of the screen to the bottom. You may need to adjust lighting to avoid screen glare when the screen is tilted upward.

Screen distance from user

The screen should first be placed at arm's length from the user, then adjusted back and forth to suit individual preference.

Starting the monitor

Turning on the monitor

► **To start the monitor:**

- 1 Touch the power button on the front of monitor. The power LED on the power button changes from purple (off) to blue (on), then turns amber/orange (standby) if no video source is detected.



Tip

For more information on EzTouch buttons, see ["Using the EzTouch menu buttons" on page 10](#).

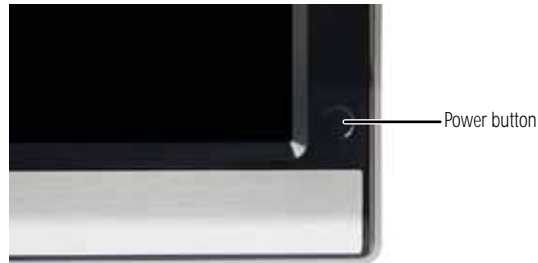

- 2 Turn on your computer. After your computer is running, the power LED on the monitor's power button should be blue, indicating that the monitor has detected a video source. Allow about 10 seconds for the display image to appear.

If you do not see an image after waiting 10 seconds, check the color of the power button light.

- No light—The monitor is not receiving power. Make sure that the monitor is plugged into an AC outlet.
- Purple—The monitor is turned off. Touch the power button to turn it on.
- Amber—The monitor is not detecting a video source. Check the video input connections and make sure that the computer is turned on and connected correctly to the monitor.
- Blue—The monitor is detecting a video source. Check the brightness setting.

For more troubleshooting information, see ["Troubleshooting" on page 19](#).

- 3 The first prompt you see is the language selection menu settings. You must select a default language for the OSD before you can proceed.









Tip

To modify the language you select at a future time, use the Advanced menu. If you cannot access the Advanced menu because you chose a language you cannot read, do the following:

- Unplug the monitor from the power outlet for ten or more seconds.
- Plug the monitor back into the power outlet.

You will be prompted for the language selection menu settings again.

- 4 Adjust the tilt of the monitor for the best viewing angle.
- 5 **For VGA input only:** After you see the Windows desktop, touch the  (**Menu**) button on the front of your monitor, then touch  (**Auto**) to automatically adjust your display image to the ideal settings.

- 6 To mute the volume of the sounds accompanying button presses, touch the  (**Menu**) button on the front of your monitor, touch  (**Main Menu**), touch  (**Advanced**), touch  (**Audio Feedback**), then touch the lower  (**Adjust**) buttons until the volume bar is at the bottom of the scale.
- 7 Use the on-screen display (OSD) to adjust other monitor settings. For more information, see ["Adjusting monitor settings" on page 10](#).
 -

Adjusting monitor settings

Use the monitor controls (located on the monitor itself) and computer controls (accessible through Windows) to adjust the display image. For more information about computer controls, see ["Changing Windows screen settings" on page 16](#).

Using the EzTouch menu buttons

This monitor features an on-screen display (OSD) and EzTouch menu buttons that let you adjust contrast, brightness, and other settings for the monitor. The monitor saves changes you make to the settings, even if you turn off the monitor. Your monitor has two levels of menus, and the functionality of the touch buttons depends on the menu that is currently open:

- The shortcut menu (the first menu that appears) lets you quickly change some of the most commonly accessed settings.
- The main menu lets you precisely adjust all levels of settings.

Using the shortcut menu

► **To use the shortcut menu:**

- 1 Touch  (**Menu**) on the front of your monitor. The rest of the button icons light up and the shortcut menu opens. (The menu's appearance and choices vary, depending on the currently active video input and whether the speaker bar is attached.)

 **Important**

The buttons are very sensitive, and may be "pressed" by holding your finger just above its surface. To completely "release" a touch button, make sure that you lift your finger well away from the button.

- 2 To use an EzTouch menu button, lightly touch its icon. For adjusting a setting's values, you can press and hold touch buttons as you would conventional buttons.

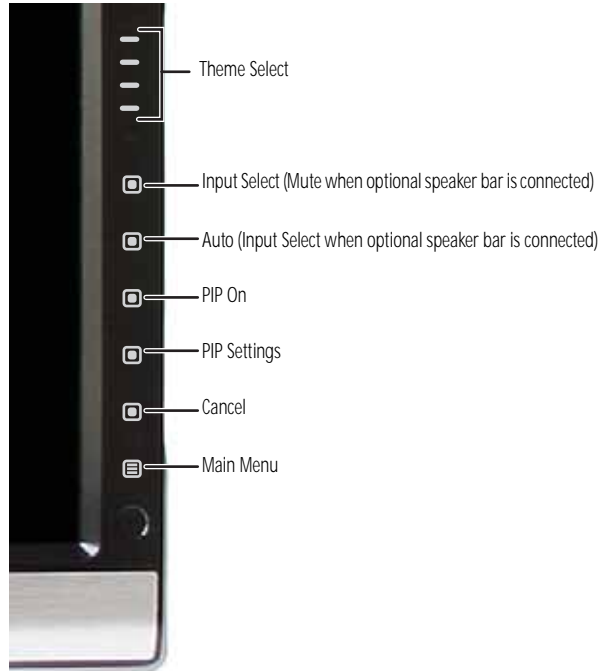

- Touch the ≡ (**Theme Select**) buttons to cycle through the preset video *themes* (brightness, contrast, and temperature configurations):
 - **User**
 - **Movie**
 - **Game**
 - **Picture**
 - **Web**
 - **Warm**
 - **Cool**
- Touch (**Input Select**) to cycle through the available video sources.

 **Important**

If, after the monitor is turned on, it does not find an active video input, the monitor enters into standby and the power LED turns orange. To manually switch inputs, touch  (**Menu**), then select the input from the on-screen list.

- Touch (**Mute**) to mute the optional speaker bar. This option is only available when the optional speaker bar is connected.
- Touch (**Auto**) to automatically adjust your display image to the ideal settings. This option is only available when the video input is VGA.
- Touch (**PIP On**) to turn on Picture-in-Picture, and touch (**PIP Settings**) to adjust the PIP position, size, and other advanced PIP settings.
- Touch (**Cancel**) to exit the shortcut menu.
- Touch  (**Main Menu**) to open the main menu.
- To turn off the button icons and close the menu, wait about ten seconds without pressing a button.



Using the main menu

► **To use the main menu:**

- 1 Touch **(Menu)** on the front of your monitor. The rest of the button icons light up and the shortcut menu opens.

Important

The EzTouch menu buttons are very sensitive, and may be "pressed" by holding your finger just above its surface. To completely "release" a touch button, make sure that you lift your finger well away from the button.

Tip

To use a button, lightly touch its icon. For adjusting a setting's values, you can press and hold touch buttons as you would conventional buttons.

- 2 Touch **(Main Menu)**. The main menu opens.

Tip

While the OSD is active, on-screen labels appear next to the buttons to help you identify them.

- 3 Touch the **(Choose Option)** buttons to highlight a setting, then touch **(Select)** to open the selected menu or setting.
- 4 Touch the **(Adjust)** buttons to adjust the setting or change the option.
- 5 Touch **(Back)** to return to a previous menu.
- 6 When you have finished making all adjustments, touch **(Menu Off)** to exit.

OSD Menu	Description
Main menu	<p>Auto—Automatically adjusts your monitor to its optimum settings. (VGA input only)</p> <p>Picture—Opens the Picture menu, where you can adjust brightness, contrast, and gamma.</p> <p>PIP Settings—Opens the PIP Settings menu, where you can adjust the source, position, size, and transparency of the Picture-in-Picture image.</p> <p>Video adjust—Opens the Video Adjust menu, where you can adjust the RGB (red, green, and blue) values of the video image from a source such as composite video, S-Video, or component video.</p> <p>Geometry—Opens the Geometry menu, where you can adjust image size and minimize distortions. (VGA input only)</p> <p>Audio—Opens the Audio menu, where you can adjust volume, bass, treble, 3D audio, audio source, and audio switching. (Speaker bar must be connected.)</p> <p>Advanced—Opens the Advanced menu, where you can adjust color balance, change the OSD language, and display information about current monitor settings.</p> <p>Reset—Resets the monitor to its factory settings for the currently displayed input.</p>
Picture menu	<p>Brightness—Adjusts the amount of light in the darkest portion of the picture. Use the lowest brightness setting you are comfortable with to maximize the life of the monitor backlights. You may need to readjust brightness after the monitor warms up.</p> <p>Contrast—Adjusts the level of white between the lightest and darkest portions of an image.</p> <p>Gamma—Customizes the gamma level. High gamma levels increase white levels and low gamma levels increase contrast.</p>
PIP Settings menu	<p>PIP Display—Toggles the display of the PIP window.</p> <p>Source—Sets the source of the video used in the PIP window.</p> <p>Position—Sets the position of the PIP window on the main screen.</p> <p>Size—Sets the size of the PIP window.</p> <p>Transparency—Sets the transparency of the PIP window. The PIP window can be from almost transparent to completely opaque. When the PIP window is transparent, you are able to see through the PIP video display to your Windows desktop, which makes it easier to access your computer programs while watching video.</p> <p>Swap—Switches the PIP image to the main image, and the main image to the PIP image.</p> <p>PIP Picture—Opens a menu where you can set the PIP brightness, contrast, saturation, and tint/hue.</p>

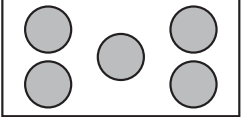
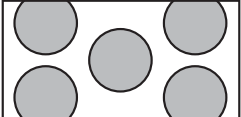
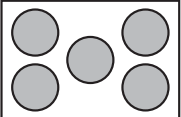
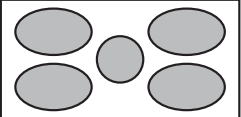
OSD Menu	Description
Video Adjust menu	<p>Unless otherwise indicated, these settings apply only to SD (standard definition) video at 480i and below. Where "PC input" is indicated, the resolutions that apply are from 800 × 600 to 1920 × 1200.</p> <p>Sharpness—Adjusts sharpness for video images.</p> <p>Video Scaling—Sets video aspect ratios and scaling between Wide, Zoom, 1:1, and Panoramic modes. PC input: Sets resolution aspect ratios and scaling between Wide, Zoom, and 1:1.</p> <p><i>Wide mode</i> stretches a standard broadcast or full-frame image to fill the entire screen. Widescreen (1.76:1) images fill the entire screen without distortion, while widescreen (1.85:1 and 2.35:1) images appear without distortion but with black bars at the top and bottom. PC input: Stretches the image to fit the entire screen.</p>  <p><i>Zoom mode</i> crops off a portion of a widescreen image in order to fill the entire screen with a distortion-free and black bar-free image. PC input: Zooms the image to fill the screen from top to bottom with black bars on the left and right sides of the image.</p>  <p><i>1:1 mode</i> preserves the movie's original aspect ratio, so a standard broadcast or full-frame movie appears with black bars on the left and right of the image. PC input: Preserves the original aspect ratio of the resolution by using black bars on the left and right sides and variable sizes of black bars on the top and bottom of the image (depends on resolution).</p>  <p><i>Panoramic mode</i> uses selective distortion to stretch a standard broadcast or full-frame image to fill the entire screen. Unlike Wide mode, Panoramic mode stretches only the left and right sides of the image, and leaves the center of the image distortion free.</p>  <p>Overscan—A video signal is often displayed slightly cut off at all edges. If Overscan is turned off, you may notice strange video anomalies on the edges of the video being displayed. This is normal and is part of the data embedded in any video signal. To avoid seeing these anomalies, turn Overscan on.</p> <p>Noise Reduction—Uses noise reduction filters that adapt to the amount of noise and motion from the video source.</p> <p>Film Mode Detection—Detects frame rates of the source image and adapts the frame rate of the display for ultimate image quality. Bad Edit Detection and Correction corrects incorrectly synchronized video.</p> <p>Auto Video Enhance—Enables DCDi, Cross Color Reduction, and MADI for optimized video performance.</p> <ul style="list-style-type: none"> ▪ <i>DCDi by Faroudja</i>—Directional Correlation De-interlacing reduces jagged edge artifacts on diagonal lines. ▪ <i>Cross Color Reduction</i>—Reduces cross-color artifacts, such as unintentional flashing colors or rainbow patterns, that result from composite video signals. ▪ <i>MADI</i>—Motion-Adaptive De-Interlacing ensures a more static (flicker-free) display image for image sections not containing moving elements, and ensures smoother edges for moving elements.
Geometry menu (VGA input only)	<p>H Position—Moves the display image left and right. You can also touch Auto to configure the vertical and horizontal position automatically.</p> <p>V Position—Moves the display image up and down. You can also touch Auto to configure the vertical and horizontal position automatically.</p> <p>Clock—Minimizes any vertical bars or stripes visible on the screen background. The horizontal screen size will also change.</p> <p>Phase—Minimizes any horizontal distortion and clears or sharpens the displayed characters.</p>

Using Picture-in-Picture (PIP)

Picture-in-Picture (PIP) is a convenient way to view video from multiple video sources at the same time. Refer to the following chart to determine which combinations of video sources can be used as a PIP display.

* Only 480i component (Y Pb Pr) video can be used with VGA as a PIP. With this combination, the Swap feature is not available. To switch to full-screen component video when 480i content is used as a PIP, touch **Input** on the sidee20.00014(i)-30.c(t)-22.2(c)-b,4 P34411423 30.,

Changing Windows screen settings

Adjusting the color depth and screen area are two of the most basic display settings you may need to change. You can also adjust settings such as the screen background and screen saver.

Changing color depth and screen resolution

Color depth and screen resolution are two of the most basic monitor settings you may need to change to suit your needs.

Color depth is the number of colors your computer uses to display images on your monitor. Most images look best displayed with the maximum number of colors available. If the color in your images seems "false" or "jumpy," especially after you have played a game or run a video-intensive program, check the color depth setting and return it to the highest color setting, if necessary.

Screen resolution is the number of pixels (individual colored dots) your computer uses to display images on your monitor. The higher the resolution, the more information and screen components (such as icons and menu bars) can be displayed on the monitor.



Help

For more information about adjusting the screen, click **Start**, then click **Help and Support**. Type **adjusting monitor settings** in the **Search Help** box, then press **ENTER**.

► To change the color depth or screen resolution in Windows Vista®:

- 1 Click **Ⓜ (Start)**, **Control Panel**, then under **Appearance and Personalization**, click **Adjust Screen Resolution**. The *Display Settings* dialog box opens.
- 2 To change the color depth, click the **Colors** list, then click the color depth you want.
 - **Low (8-bit)** = 256 colors
 - **Medium (16-bit)** = 65,500 colors
 - **Highest (32-bit)** = 16,700,000 colors
- 3 To change the screen resolution, drag the **Resolution** slider to the size you prefer.
- 4 Click **Apply**. If the new settings do not look right, click **No**. If the new settings make the screen illegible and you cannot click **No**, the settings return to their previous values after several seconds.
- 5 Click **OK**, then click **Yes** to save your changes.



► To change the color depth or screen resolution in Windows XP:

- 1 Click **Start**, then click **Control Panel**. The *Control Panel* opens. If your Control Panel is in Category View, click **Appearance and Themes**.
- 2 Click **Display**. The *Display Properties* dialog box opens.
- 3 Click the **Settings** tab.
- 4 To change the color depth, click the arrow button to open the **Color quality** list, then click the color depth you want.
 - **Low (8-bit)** = 256 colors
 - **Medium (16-bit)** = 65,500 colors
 - **Highest (32-bit)** = 16,700,000 colors
- 5 To change the screen resolution, drag the **Screen resolution** slider to the size you prefer.
- 6 Click **Apply**. If the new settings do not look right, click **No**. If the new settings make the screen illegible and you cannot click **No**, the settings return to their previous values after several seconds.
- 7 Click **OK**.



EzTune software

When installed onto your computer, EzTune™ software lets you control many of the monitor settings from your computer. With EzTune, you can:

- Change the orientation of the image (landscape to portrait) by just rotating the screen (requires the optional height-adjustable stand available in the U.S. at www.gateway.com)
- Change brightness, contrast, and color balance
- Change screen geometry
- Set the display position and resolution

For more information, see the program's CD or the installed program's online help.



Using landscape and portrait modes



EzTune automatically switches the display to the appropriate mode (landscape or portrait) when you rotate the screen. This feature works only with a Windows compatible computer running EzTune and using VGA, DVI, or HDMI input (the OSD itself does not rotate into portrait mode).

While using portrait mode:

- Full-screen video may display incorrectly or be slow.
- Video games or other full-screen applications may not be fully compatible.
- Some programs are not able to recognize and adapt to your monitor's portrait mode. If you experience problems with a program while using portrait mode, switch to landscape mode and restart the program.

Using the speaker bar



Important

If you connect the speaker bar to the monitor while the monitor is turned on, the speaker bar will not initialize and will not work correctly. If this happens, turn the monitor off, then back on to enable the speaker bar.

► To turn on the speaker bar:

- The speaker bar is always on. If you connected the speaker bar by following the instructions in [“Setting up the optional speaker bar” on page 5](#), the speaker bar receives power constantly from the monitor’s speaker bar power connector.



► To use headphones:

- Plug headphones into either of the speaker bar’s headphone jacks. The speaker bar’s volume is muted, and sound is played through the connected headphones. You can connect headphones to both headphone jacks, and sound plays out of both sets of headphones.



Power management

Energy declaration

When connected to a computer that supports the VESA Display Power Management Signaling (DPMS) Protocol, the monitor can conserve significant energy by reducing power consumption during periods of non-use. When your computer goes into the energy saving mode, the monitor will then enter the Active Off mode (sleep). In the Active Off mode the Power LED will still show orange.

Use these conventions and the power can be reduced to the following levels:

VESA State	LED Indicator	Power Consumption
On	Blue	< 150 W
Standby	Orange	< 2 W
Off	Purple	< 1 W

To “wake” the monitor when it is in Standby/Active Off mode, move the mouse or press any keyboard key. You can change the monitor’s power management settings using the Windows Control Panel. For more information, see your computer’s User Guide.

Maintaining

To keep the monitor in optimal working order:

- Do not block the ventilation holes.
- Do not expose the monitor to rain or use near water.
- Keep the monitor away from radiators or heat vents.
- Keep the monitor out of direct sunlight.



Caution

Do not use any type of abrasive pad or glass cleaner. You will permanently scratch the screen.

- To clean the monitor, use a soft cloth slightly moistened with water only. Wipe the cabinet, screen, and controls.

Troubleshooting

- If you have problems with the monitor, the information in this chapter may help you solve them without needing to call Customer Care.
- Make sure that the monitor has warmed up for about 30 minutes before making any judgments about the picture quality.

Troubleshooting symptoms

No power





- Make sure that the power cord is connected correctly to both the back of the monitor and the wall outlet. For more information about connecting the power cord, see [“Connecting the monitor” on page 2](#).



Important

If the power LED is on, the monitor is receiving power.

No picture

- Touch  (**Menu**), then  (**Input Select**) to make sure that you have selected the correct video source.
- Make sure that the power cord is connected correctly to both the back of the monitor and the wall outlet. For more information about connecting the power cord, see [“Connecting the monitor” on page 2](#).
- Make sure that the video cable is connected securely to the back of the monitor and computer. For more information about connecting the video cable, see [“Connecting the monitor” on page 2](#).
- Make sure that the monitor is turned on.
- Reset the monitor to the factory settings. For more information, see [“Advanced menu” on page 15](#).
- If the power LED is orange, it means that the monitor is not detecting a video source or input detection is disabled. Complete the following steps:
 - Move the mouse or press any key on the keyboard to bring the monitor out of sleep mode.
 - Touch  (**Menu**), then touch  (**Input Select**) to choose another input.
 - Make sure that your computer is turned on.
 - Restart your computer with the monitor turned on.
 - Make sure that the video cable is not damaged.
 - Check the end of the video cable for any pins that might be bent or pushed in.
 - Reset the OSD. For more information, see [“Advanced menu” on page 15](#).
- Turn off the monitor and unplug the video cable from the back of your computer. Turn the monitor back on and wait for ten seconds. If the monitor is functioning correctly, a “No Signal” message appears. For more information about connecting the video cable, see [“Connecting the monitor” on page 2](#).

You have the monitor connected to your notebook's VGA port but see no image on the screen.

- If your notebook supports dual displays, you can use both your notebook's display and this monitor in extended desktop multi-monitor mode. See Windows Help to learn how to enable multiple monitors.
- You can also use this monitor as your primary monitor and not use the notebook's screen. Notebook computers typically have an **Fn** key combination that lets you toggle between your notebook's display and an externally attached display. On Gateway notebooks, this key combination is **Fn+F4**. The **F4** key is located along the top row of keys. See your notebook user guide for more information.

Display colors are wrong

- Touch **(Menu)**, **(Main Menu)**, then **(Auto)** to automatically adjust the display image to the ideal settings. (VGA input only.)
- Restart your computer with the monitor turned on.
- Make sure that the video cable is connected securely to the back of the monitor and your computer. For more information about connecting the video cable, see ["Connecting the monitor" on page 2](#).
- Make sure that the video cable is not damaged.
- Check the end of the video cable for any pins that might be bent or pushed in.

Picture has shadows or "ghosts"

- Touch **(Menu)**, **(Main Menu)**, then **(Auto)** to automatically adjust the display image to the ideal settings. (VGA input only.)
- Remove any extension cables or switchboxes.
- Make sure that the video cable is connected securely to the back of the monitor and your computer. For more information about connecting the video cable, see ["Connecting the monitor" on page 2](#).
- Make sure that the video cable is not damaged.
- Check the end of the video cable for any pins that might be bent or pushed in.
- Make sure that your monitor connection is using the VGA cable that came with your monitor.

Speaker bar does not work

I installed the speaker bar, but no sound is coming out of the speakers.

- Make sure that the speaker bar power cord is plugged into the power connector on the back of your monitor, and that the monitor is plugged into an AC power outlet.
- Make sure that the speaker bar's headphone plug (green) is plugged into the headphone jack on your computer.
- If you are using HDMI audio, you must set your device to output audio in PCM mode. See the user guide that came with your device for more information.
- If you just finished installing and connecting the speaker bar, restart your monitor so that it can recognize the new speaker bar.
- Make sure that the volume is turned up.
- Make sure that headphones are not plugged into the headphone jacks on the sides of the speaker bar. When headphones are connected, no sound comes out of the speaker bar's speakers.
- Your headphone/speaker jack may have been muted using Windows sound controls. To check your headphone/speaker mute settings, click the speaker icon in the Windows taskbar, or click **⊞ (Start)**, **Control Panel, Sounds and Audio Devices**, the **Volume** tab, then click **Advanced**. For optimum volume control using the speaker bar, we recommend that you set the Windows volume mid-way between the lowest and highest setting.
- Make sure that the audio input and video input match. Touch **☰ (Menu)**, **🔊 (Audio)**, then **🔊 (Audio Switching)** to match the inputs.

I want to plug in my headphones, but there is a headphone jack on both sides of the speaker bar. Which should I use?

- You can use either jack or both jacks at the same time. When headphones are connected, no sound comes out of the speaker bar's speakers.

I do not get sound from my headphones.

- Make sure that your speaker bar is connected to an audio source by unplugging your headphones and adjusting the speaker bar volume.
- After you make sure that your speaker bar can play sounds, make sure that your headphones are plugged into one of the headphone jacks on the sides of the speaker bar, and not into the microphone jack.

The sound coming from the speakers sounds distorted.

- Turn down the volume until the distortion disappears.
- Check the audio output volume of the sound device the speaker bar is connected to. If the audio device's output volume is set too high, the speaker bar's sound may always be distorted. To adjust the audio device's output volume, see the device's user guide. To adjust the volume in Windows, click the speaker icon in the Windows taskbar, or click **⊞ (Start)**, **Control Panel, Sounds and Audio Devices**, the **Volume** tab, then click **Advanced**. For optimum volume control using the speaker bar, we recommend that you set the Windows volume mid-way between the lowest and highest setting.

I plugged my microphone into the speaker bar's microphone jack, but my computer cannot record any sound.

- Make sure that the speaker bar's microphone plug (pink) is connected to the microphone jack on your computer.
- Your microphone jack may have been muted using Windows sound controls. To check your microphone's mute settings, click the speaker icon in the Windows taskbar, or click **⊞ (Start)**, **Control Panel, Sounds and Audio Devices**, the **Volume** tab, then click **Advanced**.

FAQs

This section contains answers to frequently asked questions.

General

What is DCDi® by Faroudja?

DCDi® by Faroudja is a video mode algorithm that stands for Directional Correlation De-Interlacing. It was initially designed for fast-action video-based material. Its general purpose is to reduce jagged edges along diagonal lines caused by interpolation. Utilizing this algorithm, DCDi does not simply weave together two fields of video that match. DCDi creates new information through interpolation which “smooths” the diagonal edges. DCDi constantly monitors edge transitions and fills in any of the gaps that need smoothing.

I have the monitor connected to my notebook’s VGA port and I see no image on the screen.

You have two options:

- If your notebook supports dual displays, you can use both your notebook’s display and this monitor in extended desktop multi-monitor mode. See Windows Help to learn how to enable multiple monitors.
- You can also use this monitor as your primary monitor and not use the notebook’s screen. Notebook computers typically have an **Fn** key combination that lets you toggle between your notebook’s display and an externally attached display. On Gateway notebooks, this key combination is **Fn+F4**. The **F4** key is located along the top row of keys. See your notebook user guide for more information.

How To

Setup

Why does the image look stretched or fuzzy when I connect the monitor to my computer?

- You must adjust the operating system’s display settings to match the monitor’s optimal (*native*) 1920 × 1200 setting. For information on adjusting settings in Windows XP, see “Changing color depth and screen resolution” on page 16.

I do not see 1920 × 1200 available in the Windows display control panel.

- Make sure that your video card can display at 1920 × 1200 resolution.
- This may be caused by older video drivers on your computer. See the Gateway support Web site (support.gateway.com) for updated video drivers for your computer. You can also go directly to your video card’s support Web site for the most up-to-date video drivers. The Web sites for the major video card manufacturers are:

ATI®: <http://www.ati.com>

Intel®: <http://www.intel.com>

Nvidia®: <http://www.nvidia.com>

When I connect the monitor’s USB hub to my computer, I see an error message saying that my USB hub may not be running at full speed.

- This can happen if you connected the monitor’s high-speed USB 2.0 hub to a low-speed USB 1.1 hub or a USB 1.1 port on your computer. To use the monitor’s high-speed USB 2.0 capabilities, you must connect the monitor to a USB 2.0 port on your computer.

When I run my games, I do not see support for widescreen displays. What can I do?

- Newer games are adding support for widescreen displays as the widescreen format becomes more popular. Check the game's Web site for updates. You can also consult the following Web site for specific settings and options to configure older games to support widescreen: <http://www.widescreengamingforum.com>.

Some adjustments may require you to make changes to the Windows System Registry. We recommend making a complete system backup before changing the System Registry.

Technical

Why do I see "noise" or "trash" on the screen?

- When your display's digital capabilities exceed a digital broadcast signal, the signal is increased (*up-converted*) to match the display capabilities. Up-converting can cause "noise" or "trash." The signal on DVI-D is HDCP encoded. Stop and restart the source to allow renegotiation.

What is HDCP and how do I troubleshoot it?

- High-bandwidth Digital Content Protection (HDCP) is a specification developed by the Intel® Corporation to protect digital entertainment content that uses a digital visual interface (DVI). HDCP encrypts the transmission of digital content (signal) between the video source (computer, DVD player, or set-top box) and the digital display (monitor, digital television/DTV, or projector). HDCP is not designed to prevent copying or recording of digital content, but only to protect the integrity of the content as transmitted.

How does HDCP work?

- Implementation of HDCP requires a license obtainable from the Digital Content Protection, LLC, which then issues a set of unique secret device keys to all authorized devices. During authentication, the receiving device only accepts content after it acknowledges the keys. To further prevent stealing of the data or line tapping, the transmitter and receiver generate a shared secret value that is constantly checked throughout the transmission. After authentication is established, the transmitter encrypts the data and sends it to the receiver for decryption.

What happens if I lose signal to the display while watching a movie on a HDCP-equipped component?

- The component must be restarted to establish renegotiation.
For example, while watching a movie on a HDCP-enabled DVD player, you change the receiving device (DTV, monitor, or projector) input to watch broadcast TV, then change the input back to watch the DVD movie. However, you are unable to watch the movie. This is because when the input was changed, the receiver lost the HDCP signal. Restart the HDCP-enabled DVD player to allow renegotiation.

What is the cause if a movie starts and then slowly fades to static?

- The receiving device is not HDCP compatible or it is not negotiating correctly. Restart the video source and re-plug all video cables from the source to the TV.

How do I know if a component is HDCP compliant?

- If the video source device does not have a DVI or HDMI connection, it is not HDCP compliant.

Video/Display

When I display video from composite, or component, why does the video look overly compressed?

- See your video device user manual to adjust the video or TV format output to 16:9. Setting this option to 4:3 results in compressed video. This is done differently on all brands of video devices, so it is important that you read your video device user guide or the help tools within your video device's software.

I see black bars on left and right of the video. Can I stretch the video to fit more of the screen?

- Touch **☰ (Menu)**, **▣ (Video Adjust)**, then **▣ (Video Scaling)** to fill more of the screen. Choose **Wide**, **Zoom**, or **Panoramic** modes.

Why when I try to use Picture in Picture (PIP) component video at 480p, 720p, or 1080i, either no video is displayed or I see corrupted video?

- This is a normal operation of the monitor. If you want to view component video in PIP, adjust the video output of your external device to 480i.

Can I connect my game console to this monitor?

- Yes. Using optional video cables you can connect your game console directly to the monitor. If your game console supports HDMI or Component (YPbPr), this results in the best picture quality.

Specifications

Specifications are subject to change without notice or obligation. Many products for Gateway and its subsidiaries are custom engineered by our suppliers to Gateway specifications and may vary from similarly marketed products.

Panel size	24 inches (diagonal)
Panel type	24-inch viewable TFT active matrix TN Glare
Pixel resolution	1920 × 1200 (native) (60 Hz)
Pixel pitch	0.0106 × 0.0106 inches (0.270 mm × 0.270 mm)
Aspect ratio	16:10
Brightness	400 cd/m ²
Contrast ratio	1000:1 (typical)
Viewing angles	160° horizontal, 160° vertical
Response time	UltraResponse Enabled: 3 ms (average) UltraResponse Disabled: 5 ms (typical)
Frequency	Horizontal: 74 KHz Vertical: 60 Hz
Lamp type/life	30,000 hours (minimum)
Colors	16.7 million
Color gamut	92%
OSD languages	English, French, Spanish, Italian, Japanese
Connections and inputs	<ul style="list-style-type: none"> ▪ Analog (VGA): 15-pin mini d-sub VGA ▪ Digital (DVI-D): 24-pin DVD-D (supports 480i, 480p, 720p, 1080i, and 1080p). Includes HDCP (High-bandwidth Digital Content Protection) ▪ Composite video ▪ S-Video ▪ Component Y Pb Pr (supports 480i, 480p, 720p, 1080i, and 1080p) ▪ HDMI (supports 480i, 480p, 720p, 1080i, and 1080p) ▪ AC power input ▪ USB 2.0 B-type (input) ▪ USB 2.0 A-type (output ×4) ▪ 12V/2A speaker bar power output

Included cables	15-pin mini d-sub analog VGA DVI cable USB A-B Power
Power consumption	Normal operation: <150 W Standby mode: <2 W Off: <1 W
Power input	100~240 VAC, 50/60 Hz (built-in power supply)
Certifications	UL, cUL, FCC Class B, CE, PSE, NOM, VCCI
Wall mount bracket	VESA 4 3.937 inches (4 100 mm)
Weight	Net weight (with stand): 17.20 lbs. (7.8 kg) With stand and optional speaker bar: 19.84 lbs (9.0 kg)
Dimensions	Stand at lowest position: 22.48 × 17.36 × 9.92 inches (571 × 441 × 252 mm) Stand at highest position: 22.48 × 22.48 × 9.92 inches (571 × 571 × 252 mm)
Temperature	Operating: 41 ~95°F (5 ~35°C) Storage: -4 ~140°F (-20 ~60°C)
Humidity	Operating: 45 ~85% (non-condensing) Storage: 5 ~90% (non-condensing)
Altitude	Operating: 12,000 feet (3,658 m) Storage: 40,000 feet (12,192 m)
Security	Kensington lock slot

Video modes

Your monitor supports several video modes. If you do not use the best mode for the monitor, the display image may look slightly "fuzzy."

Mode	Resolution	Horizontal frequency (kHz)	Vertical frequency (Hz)	Available in DVI mode
1	720 × 400	31.469	70	N
2	640 × 480	31.469	60	Y
3	640 × 480	37.9	72	N
4	640 × 480	37.5	75	N
5	800 × 600	35.1	56	N
6	800 × 600	37.879	60	Y
7	800 × 600	48.1	72	N
8	800 × 600	46.875	75	N
9	1024 × 768	48.363	60	Y
10	1024 × 768	56.5	70	N
11	1024 × 768	60.123	75	N
12	1152 × 864	67.5	75	N
13	1280 × 1024	64	60	Y
14	1280 × 1024	80	75	N
15	1400 × 1050	65.317	60	Y
16	1400 × 1050	82.278	75	N
17	1440 × 900	55.935	60	Y
18	1440 × 900	70.635	75	N
19	1680 × 1050	65.29	60	Y
20	1680 × 1050	74.9	75	N
21	1920 × 1200	74	60	Y
22	1920 × 1200	74.6	60	N

Safety, Regulatory, and Legal Notices

- [Important safety information](#)
- [Environmental information](#)
- [Regulatory compliance statements](#)
- [Notices](#)

Important safety information



Warning

Always follow these instructions to help guard against personal injury and damage to your Gateway product.



Warning

Do not use Gateway products in areas classified as hazardous locations. Such areas include patient care areas of medical and dental facilities, oxygen-laden environments, or industrial facilities.

Your Gateway product is designed and tested to meet the latest standards for safety of information technology equipment. However, to ensure safe use of this product, it is important that the safety instructions marked on the product and in the documentation are followed.

Setting up your system

- Read and follow all instructions marked on the product and in the documentation before you operate your system. Retain all safety and operating instructions for future use.
- Do not use this product near water or a heat source such as a radiator.
- Set up the system on a stable work surface.
- The product should only be operated from the type of power source indicated on the rating label.
- If your product has a voltage selector switch, make sure that the switch is in the proper position for your area. The voltage selector switch is set at the factory to the correct voltage.
- Openings in the monitor case are provided for ventilation. Do not block or cover these openings. Make sure you provide adequate space, at least 6 inches (15 cm), around the system for ventilation when you set up your work area. Never insert objects of any kind into the monitor ventilation openings.
- Some products are equipped with a three-wire power cord to make sure that the product is properly grounded when in use. The plug on this cord will only fit into a grounding-type outlet. This is a safety feature. If you are unable to insert the plug into an outlet, contact an electrician to install the appropriate outlet.
- If you use an extension cord with this system, make sure that the total ampere rating on the products plugged into the extension cord does not exceed the extension cord ampere rating.

Care during use



Warning

To prevent electric shock, never remove the cover. No user serviceable parts inside. Refer servicing to qualified service personnel.

- Do not walk on the power cord or allow anything to rest on it.
- Do not spill anything on the system. The best way to avoid spills is to avoid eating and drinking near your system.
- Do not expose the monitor to rain or use near water. If the monitor does get exposed to moisture, unplug it and allow it to dry for 24 hours. Call Gateway Customer Care for advice on whether the monitor is safe to turn back on.
- When the monitor is turned off, a small amount of electrical current still flows through the monitor. To avoid electrical shock, always unplug all power cables and modem cables from the wall outlets before cleaning the system.
- Unplug the system from the wall outlet and refer servicing to qualified personnel if:
 - The power cord or plug is damaged.
 - Liquid has been spilled into the system.
 - The system does not operate properly when the operating instructions are followed.
 - The system was dropped or the cabinet is damaged.
 - The system performance changes.

Replacement parts and accessories

Use only replacement parts and accessories recommended by Gateway.

Environmental information

Recycling



Mercury Warning

Lamp(s) inside this product contain mercury and must be recycled or disposed of according to local, state, or federal laws.

The product you have purchased contains extracted natural resources that have been used in the manufacturing process. This product may contain substances known to be hazardous to the environment or to human health.

To prevent releases of harmful substances into the environment and to maximize the use of our natural resources, Gateway provides the following information on how you can responsibly recycle or reuse most of the materials in your "end of life" product.

Waste Electrical and Electronic Equipment (commonly known as WEEE) should never be disposed of in the municipal waste stream (residential garbage collection). The "Crossed-Out Waste Bin" label affixed to this product is your reminder to dispose of your "end of life" product properly.



Substances such as glass, plastics, and certain chemical compounds are highly recoverable, recyclable, and reusable. You can do your part for the environment by following these simple steps:

- When your electrical or electronic equipment is no longer useful to you, "take it back" to your local or regional waste collection administration for recycling.
- In some cases, your "end of life" product may be "traded in" for credit towards the purchase of new Gateway equipment. Call Gateway to see if this program is available in your area.
- If you need further assistance in recycling, reusing, or trading in your "end of life" product, you may contact us at the Customer Care number listed in your product's user guide and we will be glad to help you with your effort.

Finally, we suggest that you practice other environmentally friendly actions by understanding and using the energy-saving features of this product (where applicable), recycling the inner and outer packaging (including shipping containers) this product was delivered in, and by disposing of or recycling used batteries properly.

With your help, we can reduce the amount of natural resources needed to produce electrical and electronic equipment, minimize the use of landfills for the disposal of "end of life" products, and generally improve our quality of life by ensuring that potentially hazardous substances are not released into the environment and are disposed of properly.

For additional recycling information specific to your area, please go to www.gateway.com/recycle.

EPA ENERGY STAR®



As an ENERGY STAR Partner, Gateway has determined that this product meets or exceeds the ENERGY STAR 4.0 performance guidelines for computer energy efficiency and power management.

ENERGY STAR Power Management (standard in the Windows operating system) places inactive components (CPU, hard drives, and other components except memory) into a low-power Sleep mode. Sleep mode uses less energy to run your computer, saves on your energy costs, and helps protect the environment by reducing greenhouse gas emissions.

Your computer was shipped with Sleep mode enabled. While your computer is in Sleep mode, the power indicator flashes. To use your computer after it has entered Sleep mode, move the mouse, press a key on the keyboard, or press the power button to "wake" it up.

For more information about the power management features of your Gateway desktop computer, see "Changing power-saving settings" in the online *User Guide*.

For more information about the power management features of your Gateway notebook, see "Managing Power" in the online *Reference Guide*.

? Help

For more information about Sleep mode in Windows Vista, click **Start**, then click **Help and Support**. Type **sleep** in the **Search Help** box, then press ENTER.

Regulatory compliance statements

United States of America

Federal Communications Commission (FCC) Unintentional emitter per FCC Part 15

This device has been tested and found to comply with the limits for a Class B digital device, pursuant to Part 15 of the FCC rules. These limits are designed to provide reasonable protection against harmful interference in a residential installation. This equipment generates, uses, and can radiate radio frequency energy and, if not installed and used in accordance with the instructions, may cause harmful interference to radio or television reception. However, there is no guarantee that interference will not occur in a particular installation. If this equipment does cause interference to radio and television reception, which can be determined by turning the equipment off and on, the user is encouraged to try to correct the interference by one or more of the following measures:

- Reorient or relocate the receiving antenna
- Increase the separation between the equipment and receiver
- Connect the equipment to an outlet on a different circuit from that to which the receiver is connected
- Consult the dealer or an experienced radio/TV technician for help.

Compliance Accessories: The accessories associated with this equipment are: shielded video cable. These accessories are required to be used in order to ensure compliance with FCC rules.

FCC declaration of conformity

Responsible party:

Gateway, Inc.
7565 Irvine Center Drive
Irvine, CA 92618 USA

This device complies with Part 15 of the FCC Rules. Operation of this device is subject to the following two conditions: (1) this device may not cause harmful interference, and (2) this device must accept any interference received, including interference that may cause undesired operation.



Caution

Changes or modifications not expressly approved by Gateway could void the FCC compliance and negate your authority to operate the product.

California Proposition 65 warning



This product contains chemicals known to the State of California to cause cancer, birth defects, and/or other reproductive harm. For additional information regarding this product warning, go to www.gateway.com/prop65.

Canada

Industry Canada (IC) Unintentional emitter per ICES-003

This digital apparatus does not exceed the Class B limits for radio noise emissions from digital apparatus as set out in the radio interference regulations of Industry Canada.

Le présent appareil numérique n'émet pas de bruits radioélectriques dépassant les limites applicables aux appareils numériques de Classe B prescrites dans le règlement sur le brouillage radioélectrique édicté par Industrie Canada.

Notices

© 2007 Gateway, Inc.
All rights reserved.

Gateway, Inc.
7565 Irvine Center Drive
Irvine, CA 92618 USA
All Rights Reserved

This publication is protected by copyright and all rights are reserved. No part of it may be reproduced or transmitted by any means or in any form, without prior consent in writing from Gateway.

The information in this manual has been carefully checked and is believed to be accurate. However, changes are made periodically. These changes are incorporated in newer publication editions. Gateway may improve and/or change products described in this publication at any time. Due to continuing system improvements, Gateway is not responsible for inaccurate information which may appear in this manual. For the latest product updates, consult the Gateway Web site at www.gateway.com. In no event will Gateway be liable for direct, indirect, special, exemplary, incidental, or consequential damages resulting from any defect or omission in this manual, even if advised of the possibility of such damages.

In the interest of continued product development, Gateway reserves the right to make improvements in this manual and the products it describes at any time, without notices or obligation.

Trademark acknowledgments

Gateway and eMachines are trademarks or registered trademarks of Gateway, Inc. in the United States and other countries. All other brands and product names are trademarks or registered trademarks of their respective companies.

MAN FHD2400 USR GDE R0 8/07



8512497



8 27103 13691 4