

**GB**  
English

**TCFG 87C**

### Contents

#### Important information, 2-3

#### Product data, 3

#### Installation, 4

- Where to put your dryer
- Ventilation
- Water drain
- Electrical connection
- Before you start using your dryer

#### Dryer description, 5

- The features
- Control panel

#### The Display, 6

#### Start and programmes, 7-11

- Choosing a programme
- Programmes and Tables
- The controls

#### Laundry, 12-13

- Sorting your laundry
- Wash care labels
- Special clothing items
- Drying times

#### Warnings and Suggestions, 14

- General safety
- Saving energy and respecting the environment

#### Maintenance and Care, 15

- Switching off the electricity
- Cleaning the filter after each cycle
- Check the drum after each cycle
- Empty the water container after each cycle
- Cleaning the condenser unit
- Cleaning the dryer

#### Troubleshooting, 16

#### Service, 17

- Disposal

#### Hotpoint Guarantee, 19

#### Hotpoint After Sales Service, 20

! Keep this instruction booklet on hand in order to refer to it when necessary. Take it with you when you move, and should you sell this appliance or pass it on to another party, make sure that this booklet is supplied along with the dryer so that the new owner may be informed about warnings and suggestions on how the appliance works.

! Read these instructions carefully; the following pages contain important information on installation and suggestions on how the appliance works.



This symbol reminds you to read this booklet.



**GB**

Important Information

Installation

Description

The Display

Start and Programmes

Laundry

Warnings and Suggestions

Maintenance and Care

Troubleshooting

Service

# Important Information

GB

For your Condenser dryer to operate efficiently, you must follow the regular maintenance schedule shown below:

## Fluff Filter...

**!** You MUST clean the fluff filter after EVERY drying cycle.

**STEP 1.**  
Open the door of your dryer.



**STEP 2.**  
Remove the filter.



**STEP 3.**  
Open the filter and clean any fluff deposits from the filter mesh.

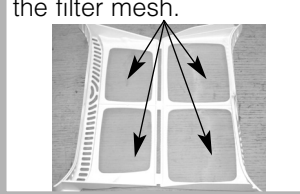

**STEP 4.**  
Refit the filter - NEVER run the dryer without the filter in position.



**!** Failure to clean the filter after EVERY drying cycle will affect the drying performance of your machine.

- It will take longer to dry and as a result will use more electricity during drying.

## Water Container...

**!** You MUST empty the water container after EVERY drying cycle.

**STEP 1.**  
Pull the water container towards you and remove it fully from the dryer.





**STEP 2.**  
Remove either the small or large cap and empty the water from the container.





**STEP 3.**  
Refit the water container, ensuring that it is pushed fully back into position.



**!** The 'Empty Water' icon  reminds you to empty the water container at the start and end of each programme.



**!** Failure to empty the water container will result in:

- The machine will stop heating (so the load may still be wet at the end of the drying cycle).
- When the water container is full, the 'Empty Water' icon  will be on, the display will show 'H20' and the 'water container full' icon  will flash.

## Priming the Water Collection System

When your dryer is new, the water container will not collect water until the system is primed... this will take 1 or 2 drying cycles. Once primed it will collect water during every drying cycle.

## Condenser Unit...

! You MUST clean the fluff from the condenser EVERY month.

### STEP 1.

Open the condenser cover - hold the handle and pull towards you.



### STEP 2.

Remove the condenser by rotating the 3 clips then pulling the condenser towards you. (There may be some water in the tubes, this is normal).

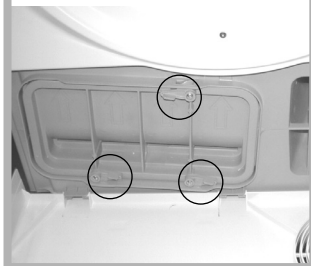

### STEP 3.

Flush the condenser, from the rear with water, to remove any fluff deposits.

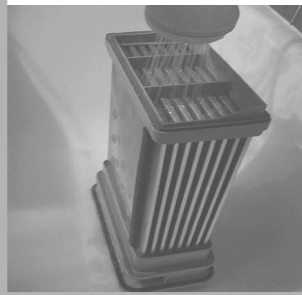

### STEP 4.

Refit the condenser unit - ensure that the unit is pushed in fully, all 3 clips are re-secured and the positioning arrows on the front of the condenser are pointing upwards.

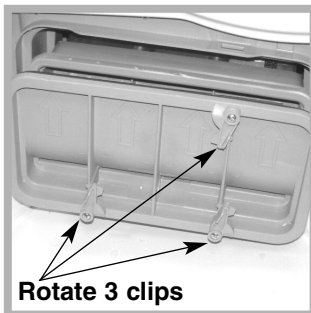

- Check that:
  - The positioning arrows are pointing upwards.
  - The 3 clips are re-secured back into their 'lock' position.

! Failure to clean the condenser could cause premature failure of your dryer.

## Product Data... (EU Regulation 392/2012)

Rated capacity of Cotton laundry for the standard programme at full load <b>8 kg</b>	Energy efficiency class <b>C</b>
The weighted Annual Energy Consumption ( $AE_c$ ) <b>627.0 kWh</b> Consumption per year, based on 160 drying cycles of the standard cotton programme at full and partial load, and the consumption of the low-power modes. Actual energy consumption per cycle will depend on how the appliance is used.	
This household tumble dryer is an <b>Automatic Condenser Dryer</b>	
Energy consumption : full load $E_{dry}$ <b>5.24 kWh</b> , partial load $E_{dry1/2}$ <b>2.92 kWh</b>	
Power consumption : off-mode ( $P_o$ ) <b>0.14 W</b> , left-on mode ( $P_l$ ) <b>2.77 W</b>	
Duration of the 'left-on mode' for power management systems <b>30</b> minutes	
The 'standard cotton programme' suitable for drying normal wet cotton laundry that is the most efficient programme in terms of energy consumption for cotton used at full and partial load is <b>Cottons - Cupboard Dry</b> .	
Programme time (minutes) : weighted ( $T_l$ ) full & partial load <b>122</b> , full load ( $T_{dry}$ ) <b>160</b> , partial load ( $T_{dry1/2}$ ) <b>94</b>	
Condensation efficiency class <b>B</b>	
Average condensation efficiency (%) : full load ( $C_{dry}$ ) <b>84</b> , partial load ( $C_{dry1/2}$ ) <b>82</b> , weighted ( $C_l$ ) full & partial load <b>83</b>	
Airborne acoustical noise emissions <b>69 dB(A) re 1 pW</b>	

This data is also available on the website <http://www.hotpoint.eu/hotpoint/>

# Installation

GB

## Where to put your dryer

- Place your dryer at a distance from gas ranges, stoves, heaters, or cook tops because flames can damage the appliance.

Minimum gap 10mm

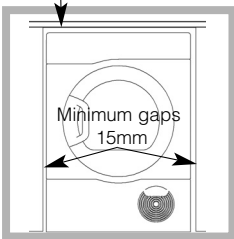

- If you are going to install the appliance under a work counter, be sure to leave a 10mm space between the top and any other objects on or above the machine and a 15mm space between the sides and lateral furnishings or walls.

This is to ensure proper air circulation.

## Ventilation

When the dryer is in use, there has to be adequate ventilation. Make sure you put your dryer in an environment that is not damp and has proper air circulation throughout. Airflow around the dryer is essential to condense the water produced during the washing, the dryer will not operate efficiently in an enclosed space or cupboard.

- ! If using the dryer in a small or cold room some condensation could be experienced.
- ! We do not recommend that the dryer is installed in a cupboard but the dryer must never be installed behind a lockable door, a sliding door or a door with a hinge on the opposite side to that of the dryer door.

## Water drain

If your dryer is installed next to a drain the water can be plumbed into this drain. This does away with the need to empty the water container. If the dryer is stacked onto or installed next to a washing machine it can share the same drain. The height of the drain must be less than 3' (1m) from the bottom of the dryer.



Remove hose from position shown (see diagram).

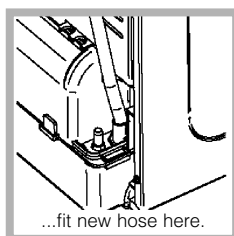

Fit a suitable length of hose to the new location shown (see diagram).

- ! Make sure that the hose is not squashed or kinked when the dryer is in its final location.

## Electrical connections

Make sure of the following before you insert the plug into the the electrical socket:

- Ensure your hands are dry.
- The socket must be grounded.
- The socket must be able to sustain the machines maximum power, which is indicated on the rating label (see *Dryer Description*).
- Power voltage must be within the values indicated on the rating label (see *Dryer Description*).
- The socket must be compatible with the dryers plug. Should this not be the case, replace the plug or the socket.

! Do not use extension cords.

! The dryer must not be installed outdoors, even if the space is sheltered. It can be very dangerous if it is exposed to rain or storms.

! Once installed, the dryers electrical wire and plug must be within easy reach.

! The power cord must not be bent or squashed.

! The power cord supplied is fitted with a BS1363 plug and a 13 amp BS1362 fuse. If you need to replace the fuse, use only those rated at 13 amp (13A) and ASTA approved to BS1362.

## Moulded plug

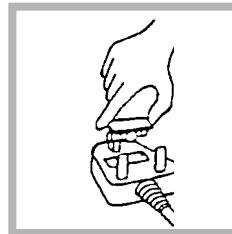

! The plug must not be used without the fuse cover in place. If a replacement fuse holder/cover is required, it must be of the same colour coding or wording as shown on the base of the plug. Replacements are available from authorised dealers.

## Changing the plug

The wires in the power cord are coloured in accordance with the following:

Green and Yellow (Earth) wire to terminal marked 'E', symbol  $\perp$ , or coloured green and yellow.

Blue (Neutral) wire to terminal marked 'N' or coloured black.

Cord clamp

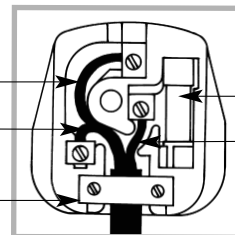

13A ASTA approved fuse to BS1362.

Brown (Live) wire to terminal marked 'L' or coloured red.

! If the plug being replaced is a non-rewirable type, then the cut-off plug must be disposed of safely. DO NOT leave it where it can be inserted into a socket and create a shock hazard.

! The power supply cord should be checked periodically and replaced by a cord specially prepared for this dryer and fitted only by authorised technicians (see *Service*). New or longer power cords are supplied at an extra charge by authorised dealers.

! The manufacturer denies any responsibility should any of these rules not be followed.

! If in doubt about any of the above consult a qualified electrician.

## Before you start using your dryer

Once you have installed your dryer and before you use it, clean the inside of the drum to remove any dust that could have accumulated during transport.

# Dryer Description

## The features

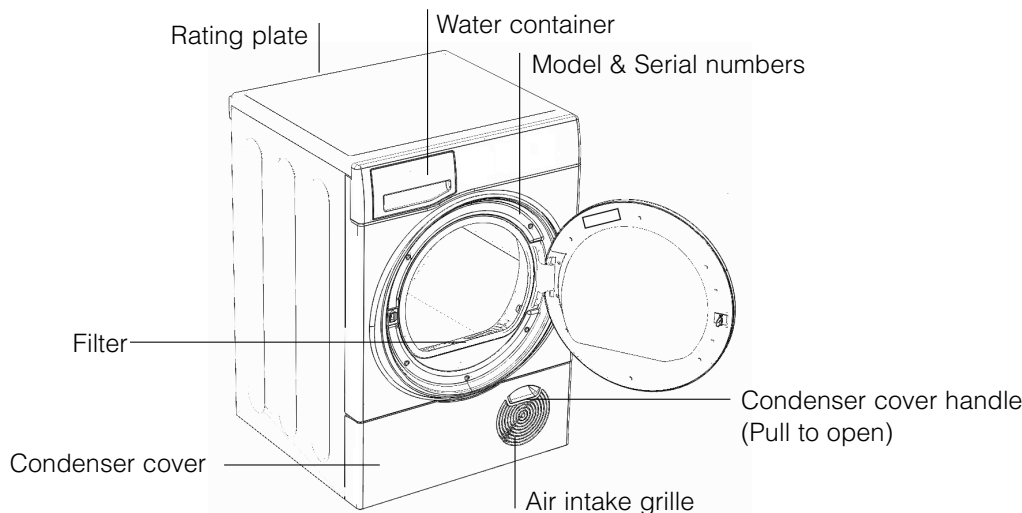

## Control panel

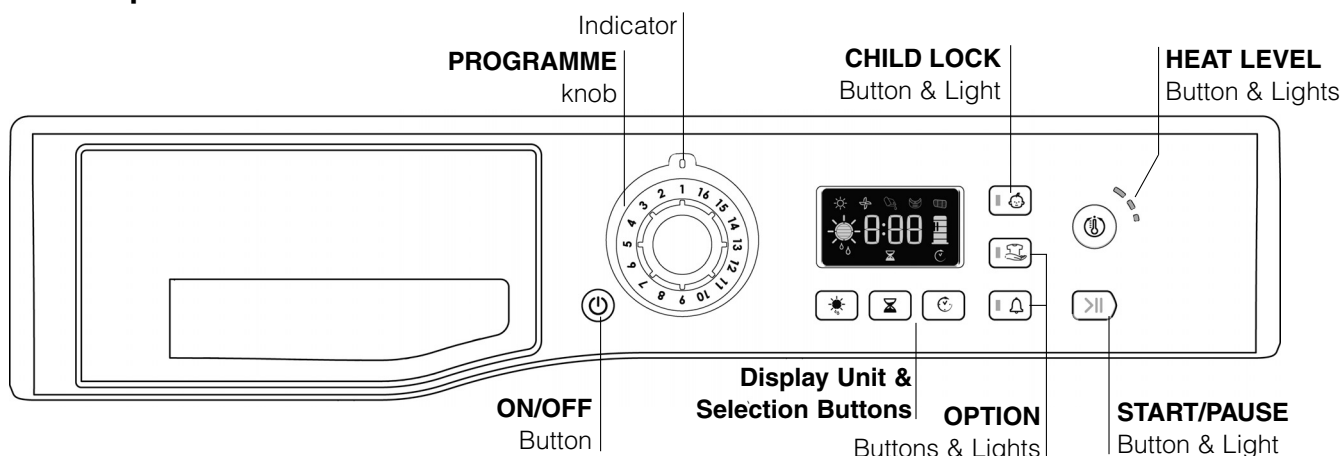

The **ON/OFF** button : If the dryer is running and this button is pressed and held for more than 3 seconds the dryer is turned off, it counts down 3, 2, 1, Off and the programme is then cancelled.

Press and hold for more than 3 seconds and the dryer reactivates.

The **PROGRAMMES** knob sets the programme: rotate it until the indicator is pointing to the programme you want to select (see *Start and Programmes*).

The **OPTION** buttons select available options for your selected programme. The lights indicate that the option has been selected (see *Start and Programmes*).

The **START/PAUSE** button/light starts a selected programme. When you press this button there will be one beep and the progress lights will flash to confirm the action. When a programme is running, holding this button in pauses the programme and stops the dryer. The light is green when programme is running, flashing amber if the programme has been paused or flashing green if on standby waiting to start a programme (see *Start and Programmes*).

The **Display Unit** gives an indication of the drying or delay time together with icons that light to give warning information and show the status of your programmes progress.

The three buttons below the display select 'Automatic' or 'Timed Dry' and if required a delayed start (see *Start and Programmes* or *The Display*).

The **CHILD LOCK** button/light : Press and hold this button after selecting your programme and any options, the light turns on. This prevents the programme settings from being changed. When the light is lit, the other buttons are disabled. Hold the button to cancel and the light will go out.

The **Empty Water** icon : signals that the water container should be emptied. The display will take a few seconds to update after replacing the empty water container, the dryer must be running for this to happen (see *The Controls*).

**Note:** If the water container fills the 'water container full' icon flashes, the display shows , the heat is turned off and your clothes will not dry.

The **Clean Filter** icon : gives a reminder before every programme, that it is essential to clean the filter every time the dryer is used (see *Maintenance and Care*).

The **Clean Condenser** icon : gives a reminder that it is essential to clean the condenser at regular intervals (see *Maintenance and Care*).

GB

Important Information

Installation

Description

The Display

Start and Programmes

Laundry

Warnings and Suggestions

Maintenance and Care

Troubleshooting

Service

# The Display

GB



The Display has three main functions, each with its corresponding button.

## Dryness Sensing Levels



After selecting a programme that has a Sensor Dry option, press and release the button until the required dryness sensing level is displayed. If the sensing option is not available with your selected programme, the display will flash and the buzzer will beep three times.

! Some sensing programmes do not have all seven dryness level options available.



Dryness levels:



**Damp Dry:**

Dries your items ready to be ironed using a machine or rotary ironer.



**Iron Dry:**

Dries your items ready to be ironed with a hand iron.



**Hanger Dry Plus:**

Dries your delicate items ready to be hanged for final drying.



**Hanger Dry:**

Dries your items ready to be hanged for final drying.



**Light Dry:**

Dries your delicate items ready to be put away.



**Cupboard Dry:**

Dries your items ready to be put away.



**Extra Dry:**

Dries your items ready to be worn.

## Timed Dry



After selecting a programme that has a Timed Dry option, press the  button and the Timed Dry icon will light, the display will reduce the selected time each time you press and release this button (*see Start and Programmes*). Each programme that has a timed option has different times available and the selection of up to 11 drying times will also depend on the heat setting that you have selected.



Each press of the button decreases the drying time.

If you change your mind, press the Sensor Dry button and the sensing level options are available.

If the Timed Dry option is not available the display will flash and the buzzer will beep three times.

The selected time remains displayed after the programme starts and can be changed during the programme if you wish.

## Delay Timer

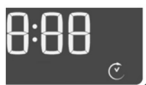

After selecting a programme that has a Delay Timer option, a delay start time can be selected.

Each press of the Delay Timer button  advances the delay setting in 30 minutes increments from **0:30** to **9:30** and then increments from **10h** to **24h** then **OFF** and then after five seconds cancels the delay.



For delays of 10 hours or more the display counts down the time in hours until 10 hours, then the display shows **9:59** and then continues to count down in minutes.

For delays 9 hours or less the display shows hours and minutes and then counts down in minutes for all of the delay.

After the START/PAUSE button  is pressed the delay time can be changed or cancelled.

When the delay period finishes the delay icon  is off and the **Time to End** is displayed.

**Note:** During this period the clothes will tumble occasionally to prevent creases developing.

## Time to End

If the delay icon  is off the time displayed is the Time to End for the programme running.

When timed programmes are selected the time displayed throughout the cycle is the actual time remaining.

When Automatic programmes are selected the time displayed is an estimate of the time remaining: When the programme is selected the display shows the time required to dry a full load, after around 10 minutes the controller calculates a better estimate of the cycle time and this is updated during the programme.

The Time to End is displayed in hours and minutes and counts down each minute.

The colons between the hours and minutes in the display flash to show the time is counting down.

The display also shows if there is a problem with your dryer, if this occurs the display will show F followed by a fault code number, the three option lights and the START/PAUSE light will also flash amber (*see Troubleshooting*).

# Start and Programmes





















## Choosing a programme

1. Plug the dryer into the electrical socket.
  2. Sort your laundry according to fabric type (*see Laundry*).
  3. Open the door and make sure the filter is clean and in place and the water container is empty and in place (*see Maintenance*).
  4. Load the machine and make sure items are not in the way of the door seal. Close the door.
  5. If none of the lights are on: Press the ON/OFF button .
  6. Choose a programme by checking the Programmes Guide (*see Programmes*) as well as the indications for each type of fabric (*see Laundry*).
    - Select a programme by rotating the PROGRAMMES knob.
  7. Choose Timed Drying or Dryness Levels option:
    - If Timed Dry press and release the Timed button until the required time is displayed.
    - or - To change from default dryness setting, press and release the Sensor Dry button until the required level is indicated (*see The Display*).
- ! For full details of selections available for each programme *see the Programme Tables*.

8. Set a delay time and other options if necessary.
9. The START/PAUSE light is flashing green:
  - press the START/PAUSE  button to begin. The green light stops flashing. During the drying programme, you can check on your laundry and take out items that are dry while others continue drying. When you close the door again, press the START/PAUSE button in order to resume drying. (*When the door is opened the START/PAUSE light will flash Amber, after the door is closed and the START/PAUSE button pressed, the START/PAUSE light will stop flashing and show green.*)
10. To let you know that your programme is complete the buzzer will beep 3 times. (**Note:** If the SOUND option was selected the buzzer beeps 3 times every 30 seconds for 5 minutes). Open the door, take the laundry out, clean the filter and replace it. Empty the water container and replace it (*see Maintenance*).
11. Unplug the dryer.

**Note:** This tumble dryer, in compliance with new energy saving regulations, is fitted with an automatic standby system which is enabled after about 30 minutes if no activity is detected.. Press and hold the ON/OFF button until the dryer reactivates.

## ESSENTIAL PROGRAMMES - Programmes Table

Programme	Options available						Dryness Levels available (default highlighted <input checked="" type="checkbox"/> )							
	 Delay Timer	 Extra Care	 Sound	 Heat Level	 Timed Dry	 Sensor Dry	 Damp Dry	 Iron Dry	 Hanger Dry Plus	 Hanger Dry	 Light Dry	 Cupboard Dry	 Extra Dry	
<b>1 Cottons</b> 	<input checked="" type="checkbox"/>	<input checked="" type="checkbox"/>	<input checked="" type="checkbox"/>	- High	<input checked="" type="checkbox"/>	<input checked="" type="checkbox"/>	<input checked="" type="checkbox"/>	<input checked="" type="checkbox"/>	<input checked="" type="checkbox"/>	<input checked="" type="checkbox"/>	<input checked="" type="checkbox"/>	<input checked="" type="checkbox"/>	<input checked="" type="checkbox"/>	<input checked="" type="checkbox"/>
				- Medium - Low	<input checked="" type="checkbox"/>	<input checked="" type="checkbox"/>	<input checked="" type="checkbox"/>	<input checked="" type="checkbox"/>	<input checked="" type="checkbox"/>	<input checked="" type="checkbox"/>	<input checked="" type="checkbox"/>	<input checked="" type="checkbox"/>	<input checked="" type="checkbox"/>	<input checked="" type="checkbox"/>
<b>2 Shirts</b> 	<input checked="" type="checkbox"/>	<input checked="" type="checkbox"/>	<input checked="" type="checkbox"/>	- High - Medium	<input checked="" type="checkbox"/>	<input checked="" type="checkbox"/>	<input checked="" type="checkbox"/>	<input checked="" type="checkbox"/>	<input checked="" type="checkbox"/>	<input checked="" type="checkbox"/>	<input checked="" type="checkbox"/>	<input checked="" type="checkbox"/>	<input checked="" type="checkbox"/>	<input checked="" type="checkbox"/>
				- High - Medium	<input checked="" type="checkbox"/>	<input checked="" type="checkbox"/>	<input checked="" type="checkbox"/>	<input checked="" type="checkbox"/>	<input checked="" type="checkbox"/>	<input checked="" type="checkbox"/>	<input checked="" type="checkbox"/>	<input checked="" type="checkbox"/>	<input checked="" type="checkbox"/>	<input checked="" type="checkbox"/>
<b>3 Bed &amp; Bath</b> 	<input checked="" type="checkbox"/>	<input checked="" type="checkbox"/>	<input checked="" type="checkbox"/>	- High	<input checked="" type="checkbox"/>	<input checked="" type="checkbox"/>	<input checked="" type="checkbox"/>	<input checked="" type="checkbox"/>	<input checked="" type="checkbox"/>	<input checked="" type="checkbox"/>	<input checked="" type="checkbox"/>	<input checked="" type="checkbox"/>	<input checked="" type="checkbox"/>	<input checked="" type="checkbox"/>
				- Medium	<input checked="" type="checkbox"/>	<input checked="" type="checkbox"/>	<input checked="" type="checkbox"/>	<input checked="" type="checkbox"/>	<input checked="" type="checkbox"/>	<input checked="" type="checkbox"/>	<input checked="" type="checkbox"/>	<input checked="" type="checkbox"/>	<input checked="" type="checkbox"/>	<input checked="" type="checkbox"/>
<b>4 Anti Allergy</b> 	<input checked="" type="checkbox"/>	<input checked="" type="checkbox"/>	<input checked="" type="checkbox"/>	<input checked="" type="checkbox"/>	• An Automatic programme									
<b>5 Synthetics</b> 	<input checked="" type="checkbox"/>	<input checked="" type="checkbox"/>	<input checked="" type="checkbox"/>	- Medium - Low	<input checked="" type="checkbox"/>	<input checked="" type="checkbox"/>	<input checked="" type="checkbox"/>	<input checked="" type="checkbox"/>	<input checked="" type="checkbox"/>	<input checked="" type="checkbox"/>	<input checked="" type="checkbox"/>	<input checked="" type="checkbox"/>	<input checked="" type="checkbox"/>	<input checked="" type="checkbox"/>
<b>6 Quick Dry</b> 	<input checked="" type="checkbox"/>	<input checked="" type="checkbox"/>	<input checked="" type="checkbox"/>	- High - Medium	• An Automatic programme									

### Cottons

- This is a programme for cotton items.
- The duration of this programme will depend on the size of the load, the dryness setting selected and the spin speed used in your washer (*see Laundry*).

GB

Important Information

Installation

Description

The Display

Start and Programmes

Laundry

Warnings and Suggestions

Maintenance and Care

Troubleshooting

Service



# Start and Programmes

GB

## Shirts

### High heat option

- This is a programme for shirts made from cotton.
- It can be used for load sizes up to 3kg (approximately 10 shirts).

### Medium heat option

- This is a programme for shirts made from synthetic materials or a mixture of natural and synthetic materials, such as polyester and cotton.
- It can be used for load sizes up to 3kg (approximately 14 shirts).

The duration of this programme will depend on the size of the load, the dryness setting selected and the spin speed used in your washer.

Loads dried using the Cupboard Dry setting are usually ready to wear, the edges or seams may be slightly damp. If this is the case, try turning the shirts inside out and running the programme again for a short period.

## Bed & Bath

- This is a programme for cotton towels and sheets.
- The duration of this programme will depend on the size of the load, the dryness setting selected and the spin speed used in your washer (*see Laundry*).
- Loads dried using the Extra Dry setting are usually ready to use, the edges or seams may be slightly damp especially on large items. If this is the case, try opening them out and running the programme again for a short period.

## Anti Allergy Programme

This programme has the 'Seal of Approval' endorsement from Allergy UK, which reflects the effective reduction and elimination of allergens from the clothes with the special Anti Allergy cycle. With this programme, thanks to the achievement of constant temperature for an extended period of time, the effects of the most common allergens (including House Mites and Pollen) are neutralised.

Can be used on a full size wet load to dry and treat, or on a 4kg dry load just to treat your laundry.



















## Synthetics

- This is a programme for items of Synthetic or Synthetic/Cotton mixtures.
- The duration of this programme will depend on the size of the load, the dryness setting selected and the spin speed used in your washer (*see Laundry*).

## Quick Dry

This programme is for small loads maximum 1kg. **Note:** can only be used with the Cupboard Dry setting. Your drying time is very much reduced with a huge time saving up to 53% on cottons (with High Heat option) and 50% on synthetics (with Medium Heat option).

## EXCLUSIVE PROGRAMMES - Programmes Table

Programme	Options available						Dryness Levels available (default highlighted <input checked="" type="checkbox"/> )						
													
<b>7 Jeans</b> 	✓	X	✓	X	X	✓	✓	✓	✓	✓	✓	<input checked="" type="checkbox"/>	✓
<b>8 Wool</b> 	X	X	✓	X	• An Automatic programme								
<b>9 Silk</b> 	X	X	✓	X	X	✓	✓	✓	✓	✓	✓	<input checked="" type="checkbox"/>	X
<b>10 Delicates</b> 	✓	X	✓	X	✓	✓	✓	✓	✓	✓	✓	<input checked="" type="checkbox"/>	X
<b>11 Duvet</b> 	✓	X	✓	- High - Medium	• An Automatic programme								
<b>12 Baby cycle</b> 	✓	X	✓	X	✓	✓	✓	✓	✓	✓	✓	<input checked="" type="checkbox"/>	X



## Jeans

- This is a programme for jeans made from denim cotton. Before drying your jeans turn the front pockets inside out.
- It can be used for load sizes up to 3kg (approximately 4 pairs).
- Do not mix dark and light coloured items.
- It can also be used on other garments made from the same material, such as jackets.
- The duration of this programme will depend on the size of the load and the spin speed used in your washer.
- Loads dried using this programme are usually ready to wear, the edges or seams may be slightly damp. If this is the case, try turning the jeans inside out and running the programme again for a short period.

! We do not recommend that you use this programme if your jeans have elastic waist bands, studs or embroidery.

## Wool Programme

- This is a programme for tumble dryer safe garments marked with the symbol .
- It can be used for load sizes up to 1kg (approximately 3 sweaters).
- We recommend that garments are turned inside out before drying.
- The duration of this programme will depend on the size and density of the load and the spin speed used in your washer.
- Loads dried using this programme are usually ready to wear, but on some heavier garments the edges may be slightly damp. Allow these to dry naturally as over-drying could damage garments.

! Unlike other materials, the mechanism of wool shrinkage is irreversible; i.e. it will not stretch back to original size and shape.

! This programme is not suitable for Acrylic garments.

## Silk

- This is a programme for drying your delicate silk.
- It can be used for load sizes up to 0.5kg.
- The duration of this programme will depend on the size and density of the load and the spin speed used in your washer.
- Loads dried using this programme are usually ready to use, but on some heavier garments the edges may be slightly damp. If this is the case, remove the load and open them out and then run the programme again for a short period.

## Delicates

- This is a programme for drying your delicate clothes ie. Acrylics.
- It can be used for load sizes up to 2kg.
- The duration of this programme will depend on the size and density of the load and the spin speed used in your washer.
- Loads dried using this programme are usually ready to use, but on some garments the edges may be slightly damp. If this is the case, try opening them out or turn items inside out and running the programme again for a short period.

## Duvet

! Take care with this programme DO NOT dry any items that are damaged which could result in the filling blocking the filter and air vent resulting in a fire hazard.

- Must only be used on single size duvets: NOT suitable for double or king size items.
- Loads dried using this programme are usually ready to use, but may be slightly damp in places. If this is the case, try opening them out and shaking them and running the programme again for a short period.
- Also suitable for down filled jackets.
- Select high heat for Cotton Duvets and medium heat for Synthetic duvets
- The duration of this programme will depend on the size and density of the load and the spin speed used in your washer.

## Baby cycle

- This is a programme for drying your baby's small delicate items of clothing and bedding (Cotton and Chenille) and for drying your delicate clothes.
- DO NOT dry items such as bibs and nappy pants with plastic coverings.
- It can be used for load sizes up to 2kg.
- The duration of this programme will depend on the size and density of the load and the spin speed used in your washer.
- Loads dried using this programme are usually ready to use, but on some garments the edges may be slightly damp. If this is the case, try opening them out or turn items inside out and running the programme again for a short period.

GB

Important Information

Installation

Description

The Display

Start and Programmes

Laundry

Warnings and Suggestions

Maintenance and Care

Troubleshooting

Service

# Start and Programmes

GB

## EXTRA PROGRAMMES - Programmes Table

Programme	Options available						Dryness Levels available (default highlighted <input checked="" type="checkbox"/> )						
	Delay Timer	Extra Care	Sound	Heat Level	Timed Dry	Sensor Dry	Damp Dry	Iron Dry	Hanger Dry Plus	Hanger Dry	Light Dry	Cupboard Dry	Extra Dry
<b>13 Cuddly Toys</b>	<input checked="" type="checkbox"/>	<input type="checkbox"/>	<input checked="" type="checkbox"/>	<input type="checkbox"/>	• An Automatic programme								
<b>14 Heat &amp; Enjoy</b>	<input type="checkbox"/>	<input type="checkbox"/>	<input type="checkbox"/>	<input type="checkbox"/>	• An Automatic programme								
<b>15 Easy Iron</b>	<input type="checkbox"/>	<input type="checkbox"/>	<input checked="" type="checkbox"/>	<input type="checkbox"/>	• An Automatic programme								
<b>16 Refresh</b>	<input type="checkbox"/>	<input type="checkbox"/>	<input checked="" type="checkbox"/>	<input type="checkbox"/>	• An Automatic programme								

### Cuddly Toy Programme

With this programme you can remove dust easier and wash the cuddly toys more often because the drying time is very much reduced compared to drying in the open air. It is a delicate drying cycle that dries at low temperature and with soft mechanical action to maintain at best the original look and shine of the fur.

**Note:** For allergy protection, just freeze cuddly toys for 24 hours then wash and dry them. Repeat every 6 weeks. Before drying remove accessories such as clothes, collars or sound boxes and protect plastic eyes with masking tape after drying them with a cloth.

The programme time will vary dependant on the exact make up of the load.

The maximum load should not exceed 2.5kg and no individual item should be greater than 600g.

### Heat & Enjoy

This programme helps to heat towels & bathrobes for a warm sensation after a bath or shower. It is also useful for warming clothes before dressing during winter. The cycle heats clothes to 37°C (Body Temperature) and runs at this temperature for a maximum of 4 hours or until you stop the cycle by opening the door.

Maximum load 3kg.

**Note:** During this programme a ♂ icon rotates in the display until the target temperature is reached, at which point the ☀ icon flashes.

### Easy Iron Programme

'Easy Iron' is a short 10 minute programme (8 minutes of heat followed by a 2 minute cool tumble period) which fluffs the fibres of clothing that have been left in the same position/location for an extended period of time. The cycle relaxes the fibres and makes them easier to iron and fold.

! 'Easy Iron' is **not a drying programme** and should not be used for wet articles of clothing.

For best results:

1. Do not load more than the maximum capacity. These numbers refer to the dry weight:

Fabric	Maximum load
Cotton and Cotton mixtures	2.5kg
Synthetics	2kg
Denim	2kg

2. Unload the dryer immediately after the end of the programme, hang, fold or iron the articles and put them away in the closet. Should this not be possible repeat the programme.

The 'Easy Iron' effect varies from one fabric to the next. It works well on traditional fabrics like Cotton or Cotton mix, and less well on acrylic fibres and on materials such as Tencel®.

### Refresh

! 'Refresh' is **not a drying programme** and should not be used for wet articles of clothing.

- It can be used on any load size but is more effective on smaller loads.
- Do not overload your dryer (see *Laundry*).
- This is a 20 minute programme that airs your clothes with cool air. Also use to cool warm clothes.

## The Controls

### • Programmes knob

**! Warning**, if after pressing the START/PAUSE button >|| the programme knob position has changed, the new position will **NOT** change the programme selected.

To change a selected programme, press the START/PAUSE button >||, the light flashes Amber to indicate the programme is paused. Select the new programme and any options required, the light will then flash green. Press the START/PAUSE button >|| again and the new programme will start.

### • OPTION buttons / lights

These buttons are used to customise the selected programme to your requirements. A programme must have been selected on the programme knob before an option can be selected. Not all options are available for all programmes (*see Start and Programmes*). If an option is not available and you press the button, the buzzer will beep three times. If the option is available the option light in the button lights to confirm the selection.

After the START/PAUSE button has been pressed only the Sound option (where available) can be changed.

### Progress (☀️ Drying, 🌀 Cool Tumble) icons

These are part of the Display, they indicate the progress of the dryer. Each icon comes on as the corresponding phase starts.

### 🕒 Time Delay (Delay Timer)

The start of some programmes (*see Start and Programmes*) can be delayed for up to 24 hours. Ensure the water container is emptied before setting a delayed start. During this period the clothes are tumbled to help prevent creases developing.

### 🧺 Extra Care

This Anti-Ageing function for Cottons helps to maintain the brightness of your laundry for a long time, thanks to the correct drum rotation (reduced in the last part of the cycle) and the correct temperature.

**Note:** It cannot be used with the 'Extra Dry', 'Cupboard Dry' and 'Light Dry' dryness levels.

### 🔊 Heat Level buttons and lights

Not all programmes allow you to change the heat level and some programmes allow all three heat level options: Low, Medium and High.

When the heat level options are available pressing this button changes the heat level and the light corresponding to the selection is lit.

### 🔊 Sound

If selected, gives a signal at the end of the drying cycle, to remind you that the clothes are ready to be removed. Not available with the Heat & Enjoy programme.

### • DISPLAY 8:88

The display shows either the amount of time delay remaining or an indication of the amount of time left for a drying programme (*see The Display*).

The colons between the hours and minutes in the display flash to show that the time is counting down.

When the programme finishes its cool tumble phase the display will show 'End'.

### • Empty Water Icon / Container

(If you have plumbed your dryer to a drain this icon can be ignored, as there is no need to empty the water container).

When this icon is on (🚰) it reminds you to empty the water container.

If the water container fills during a programme, the heater turns off and the dryer does a period of Cool Tumble then the buzzer sounds, the 'water container full' icon 🚰 flashes, the display shows H20 and the 'empty water' icon 🚰 is on.

You must empty the water container and restart the dryer or the clothes will not dry. After re-starting the dryer the display will take a few seconds to refresh. To avoid this always empty the water container each time you use the dryer (*see Maintenance*).

### • Door Opening

Opening the door (or pressing the Start/Pause button) during a programme will stop the dryer and have the following effects:

- The START/PAUSE light flashes Amber.
- During a delay phase the delay will continue to count down. The START/PAUSE button **must** be pressed to resume the delay programme.
- The START/PAUSE button **must** be pressed to resume programme. The progress lights will change to show the current status and the Start/Pause light will stop flashing and turn green.
- Changing the programmes knob will select a new programme and the START/PAUSE light will flash green. You can use this to select the Refresh programme 🧺 to cool the clothes, if you find them dry enough. Press the START/PAUSE button to begin a new programme.

### • Note

If you have a power cut, switch off the power or remove the plug. When power is restored, press and hold the ON/OFF button until the dryer reactivates, then press the Start/Pause button.

GB

Important Information

Installation

Description

The Display

Start and Programmes

Laundry

Warnings and Suggestions

Maintenance and Care

Troubleshooting

Service

# Laundry

GB

## Sorting your laundry

- Check symbols on clothing labels to make sure that the articles can be tumble dried.
  - Sort laundry by fabric type.
  - Empty pockets and check buttons.
  - Close zippers and hooks and tie loose belts and strings.
  - Wring out each item in order to eliminate as much excess water as possible.
- ! Do not load dripping wet clothes into the dryer.

### Maximum load size

Do not load more than maximum capacity.

These numbers refer to dry weight:

Natural fibres: 8kg max (18lb)

Synthetic fibres: 3kg max (6.6lb)

! DO NOT overload the dryer as this could result in reduced drying performance.

## Typical weights

**Note:** 1kg = 1000g (1lb = 16oz)





Clothes			
Blouse	Cotton	150g	(5oz)
	Other	100g	(3oz)
Dress	Cotton	500g	(1lb 2oz)
	Other	350g	(12oz)
Jeans		700g	(1lb 6oz)
10 nappies		1000g	(2lb 3oz)
Shirt	Cotton	300g	(10oz)
	Other	200g	(7oz)
T-Shirt		125g	(4oz)

Household Items			
Duvet cover (Double)	Cotton	1500g	(3lb 5oz)
	Other	1000g	(2lb 3oz)
Large Tablecloth		700g	(1lb 6oz)
Small Tablecloth		250g	(9oz)
Tea Towel		100g	(3oz)
Bath Towel		700g	(1lb 6oz)
Hand Towel		350g	(12oz)
Double Sheet		500g	(1lb 2oz)
Single Sheet		350g	(12oz)

At the end of a drying cycle, cottons could still be damp if you grouped cottons and synthetics together. If this happens simply give them an additional short period of drying.

## Wash Care Labels

Look at the labels on your garments, especially when tumble drying for the first time. The following symbols are the most common:

-  May be tumble dried
-  Do **not** tumble dry
-  Tumble dry at high heat setting
-  Tumble dry at low heat setting

## Items not suitable for tumble drying

- Articles that containing rubber or rubber-like materials or plastic film (pillows, cushions, or PVC rainwear), any other flammable articles or objects that contain flammable substances (towels soiled with hair spray).
- Glass fibres (certain types of draperies)
- Items which have been dry cleaned
- Items with the ITCL Code  (*see Special clothing items*). These can be cleaned with special at-home dry cleaning products. Follow instructions carefully.
- Large bulky items (quilts, sleeping bags, pillows, cushions, large bedspreads etc). These expand when drying and would prevent airflow through the dryer.

## Special clothing items

**Blankets and Bedspreads:** acrylic items (Acilan, Courtelle, Orion, Dralon) **must be dried** with special care on LOW heat setting. Avoid drying for a long period of time.

**Pleated or creased garments:** read the manufacturer's drying instructions on the garment.

**Starched articles:** do not dry these with non-starched items. Make sure that as much of the starch solution is removed from the load as possible before placing it in the dryer. Do not over-dry: the starch will become powdery and leave your clothing limp, which defeats the purpose of starch.

## Drying times

The table (*see below*) presents APPROXIMATE drying times in Minutes. Weights refer to dry garments.

Times are approximate and can vary depending upon:

- Amount of water retained in clothes after spin cycle: towels and delicates retain a lot of water.

- Fabrics: items that are the same type of fabric but different textures and thicknesses may not have the same drying time.
- Quantity of laundry: single items or small loads may take longer to dry.
- Dryness: If you are going to iron some of your clothes, they can be taken out while still a bit damp. Others can be left longer if you need them to be completely dry.
- Heat setting.
- Room temperature: if the room where the dryer is located is cold, it will take longer for the dryer to dry your clothes.
- Bulk: some bulky items can be tumble dried with care. We suggest that you remove these items several times, shake them out, and return them to the dryer until finished.

**!** Do not over-dry your clothes. All fabrics contain a little natural moisture, which keeps them soft and fluffy.

<b>Cottons</b>  High/Full Heat	Drying times 800-1000 rpm in washing machine.							
	1 kg	2 kg	3 kg	4 kg	5 kg	6 kg	7 kg	8 kg
	30 - 40	40 - 55	55 - 70	70 - 80	80 - 90	95 - 120	120 - 140	130 - 150
<b>Synthetics</b>  Gentle/Low Heat	Drying times on reduced spin in washing machine.							
	1 kg		2 kg			3 kg		
	40 - 50		50 - 70			70 - 90		
<b>Acrylics</b>  Gentle/Low Heat  (Use Timed Dry programmes)	Drying times on reduced spin in washing machine.							
	1 kg				2 kg			
	30				60			

# Warnings and Suggestions

GB

! The appliance has been designed and built according to international safety standards. These warnings are given for safety reasons and must be followed carefully.

## General safety

- This tumble dryer is not intended for use by persons (including children) with reduced physical, sensory or mental capabilities, or lack of experience and knowledge, unless they have been given supervision or instruction concerning use of the appliance by a person responsible for their safety.
- This tumble dryer has been designed for home, and not professional use.
- Do not touch the appliance while barefoot or with wet hands or feet.
- Unplug the machine by pulling on the plug, not the cord.
- Children must not be in proximity of the dryer when in use. After using the dryer, turn it off and unplug it. Keep the door closed to make sure that children do not use it as a toy.
- Children should be supervised to ensure that they do not play with the dryer.
- The appliance must be installed correctly and have proper ventilation. The air intake at the front of the dryer should never be obstructed (*see Installation*).
- Never use the dryer on carpeting where the pile height would prevent air from entering the dryer from the base.
- Check to see if the dryer is empty before loading it.
-  The back of the dryer could become very hot. Never touch it while in use.
- Do not use the dryer unless the filter, water container and condenser are securely in place (*see Maintenance*).
- Do not overload the dryer (*see Laundry* for maximum loads).
- Do not load items that are dripping wet.
- Carefully check all instructions on clothing labels (*see Laundry*).
- Do not tumble dry large, very bulky items.
- Do not tumble dry acrylic fibres at high temperatures.
- Complete each programme with its Cool Tumble Phase.
- Do not turn off the dryer when there are still warm items inside.
- Clean the filter after each use (*see Maintenance*).
- Empty the water container after each use (*see Maintenance*).
- Clean the condenser unit at regular intervals (*see Maintenance*).
- Do not allow lint to collect around the dryer.
- Never climb on top of the dryer. It could result in damage.
- Always follow electrical standards and requirements (*see Installation*).
- Always buy original spare parts and accessories (*see Service*).

## To minimise the risk of fire in your tumble dryer, the following should be observed:

- Tumble dry items only if they have been washed with detergent and water, rinsed and been through the spin cycle. It is a fire hazard to dry items that HAVE NOT been washed with water.
- Do not dry garments that have been treated with chemical products.
- Do not tumble dry items that have been spotted or soaked with vegetable or cooking oils, this constitutes a fire hazard. Oil-affected items can ignite spontaneously, especially when exposed to heat sources such as a tumble dryer. The items become warm, causing an oxidation reaction with the oil. Oxidation creates heat. If the heat cannot escape, items can become hot enough to catch fire. Piling, stacking or storing oil-affected items can prevent heat from escaping and so create a fire hazard. If it is unavoidable that fabrics containing vegetable or cooking oil or those that have been contaminated with hair care products be placed in a tumble dryer they should first be washed with extra detergent - this will reduce, but not eliminate the hazard. The cool tumble phase should be used to reduce the temperature of the items. They should not be removed from the dryer and piled or stacked while hot.
- Do not tumble dry items that have previously been cleaned in or washed in, soaked in or soiled with petrol/gasoline, dry cleaning solvents or other flammable or explosive substances. Highly flammable substances commonly used in domestic environments including cooking oil, acetone, denatured alcohol, kerosene, spot removers, turpentine, waxes and wax removers. Ensure these items have been washed in hot water with an extra amount of detergent before being dried in the tumble dryer.
- Do not tumble dry items containing foam rubber (also known as latex foam), or similarly textured rubber like materials. Foam rubber materials can, when heated, produce fire by spontaneous combustion.
- Fabric softener or similar products should not be used in a tumble dryer to eliminate the effects of static electricity unless the practice is specifically recommended by the manufacturer of the fabric softener product.
- Do not tumble dry undergarments that contain metal reinforcements eg. bras with metal reinforcing wires. Damage to the tumble dryer can result if the metal reinforcements come loose during drying.
- Do not tumble dry rubber, plastic articles such as shower caps or babies waterproof covers, polythene or paper.
- Do not tumble dry rubber backed articles, clothes fitted with foam rubber pads, pillows, galoshes and rubber coated tennis shoes.
- Remove all objects from pockets, especially lighters (risk of explosion).

! WARNING: Never stop the dryer before the end of the drying cycle unless all items are quickly removed and spread out so that the heat is dissipated.

## Saving energy and respecting the environment

- Wring out items to eliminate excess water before tumble drying (if you use a washing machine first, select a high spin cycle). Doing this will save time and energy during drying.
- Always dry full loads - you save energy: single items or small loads take longer to dry.
- Clean the filter after each use to contain energy consumption costs (*see Maintenance*).

## Switching off the electricity

! Unplug your dryer when not using it, when cleaning it and during all maintenance operations.

## Clean the filter after each cycle

The filter is an important part of your dryer: it accumulates lint and fluff that is formed while drying. When finished drying, clean the filter by rinsing it under running water or with your vacuum cleaner. Should the filter become clogged up, the airflow inside the dryer will be seriously compromised: drying times lengthen and you will consume more energy. It may also damage your dryer.

The filter is found in front of the dryer trim (*see diagram*). Removing the filter:

1. Pull the plastic grip of the filter upwards (*see diagram*).
2. Open the filter and clean the lint from the inside.
3. Replace it correctly. Ensure the filter is fully located flush into the tumble dryer trim.
4. Remove any lint that has built up on the inside of the door and around the door seal.

! Do not use the dryer without replacing the filter.

## Check the drum after each cycle

Turn the drum manually in order to remove small items (handkerchiefs) that could have been left behind.

## Empty the water container after each cycle

Pull the container out of the dryer and remove either the small or large cap and empty it into a sink or other suitable drain. Refit the cap and replace the container securely.

! Always check and empty the container before you start a new drying programme.

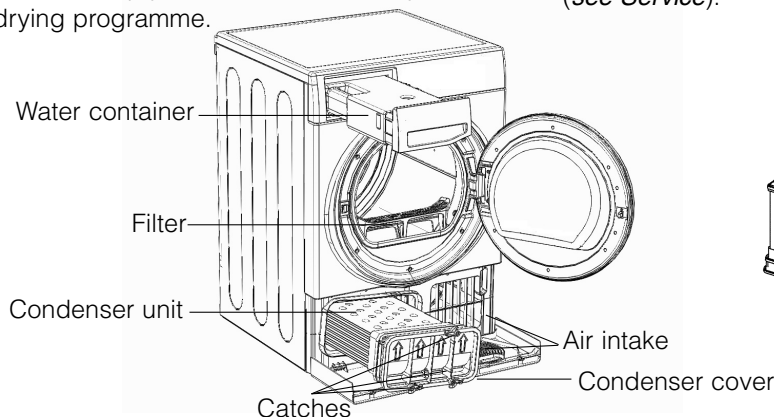

## Cleaning the drum

! Do not use abrasives, steel wool or stainless steel cleaning agents to clean the drum.

A coloured film may start to appear on the stainless steel drum, this may be caused by a combination of water and, or cleaning agents such as fabric conditioner from the wash. This coloured film will not affect the dryer performance.

## Cleaning the condenser unit

Periodically (every month) remove the condenser unit and clean any build up of fluff from between the plates by rinsing it under the tap with cold water.

This should be done with cold water from the rear of the condenser.

Removing the condenser:

1. Unplug the dryer and open the door.
2. Pull open the condenser cover (*see diagram*). Release the three catches by turning 90° counter-clockwise then pull on the grip and remove from the dryer.
3. Clean the surface of the seals and replace, making sure that the catches have been secured.

## Cleaning the dryer

- External parts in metal or plastic and rubber parts can be cleaned with a damp cloth.
- Periodically (every 6 months) vacuum the front air intake grille, to remove any build up of fluff, lint or dust. Also to remove accumulation of fluff from the front of the condenser and filter areas, clean occasionally with a vacuum cleaner.

! Do not use solvents or abrasives.

! Your dryer uses special bearing components which do not need lubrication.

! Have your dryer checked regularly by authorised technicians to ensure electrical and mechanical safety (*see Service*).



# Troubleshooting

GB

One day your dryer seems not to be working. Before you call your Service Centre (*see Service*), go through the following troubleshooting suggestions:

## Problem:

## Possible causes / Solution:



### The tumble dryer won't start.

- The plug is not plugged into the socket, or not making contact.
- There has been a power failure.
- The fuse has blown. Try to plug another appliance into the socket.
- You are using an extension cord? Try to plug the dryer's power cord directly into the socket.
- The door is not closed securely?
- The PROGRAMMES knob has not been set properly (*see Start and Programmes*).
- The START/PAUSE button has not been pressed (*see Start and Programmes*).

### Drying cycle will not begin.

- You have set a delayed time (*see Start and Programmes*).

### Its taking a long time to dry.

- The filter has not been cleaned (*see Maintenance*).
- The water container needs emptying... The 'water container full' icon  is flashing, the display shows  and the 'empty water' icon  is on (*see Maintenance*).
- The condenser needs cleaning? (*see Maintenance*).
- The temperature setting is not ideal for the type of fabric you are drying (*see Start and Programmes, and see Laundry*).
- The correct drying time has not been selected for the load (*see Laundry*).
- The air intake grille is obstructed (*see Installation, and see Maintenance*).
- The items were too wet (*see Laundry*).
- The dryer was overloaded (*see Laundry*).

### The 'water container full' icon is flashing and displayed but the dryer has only been running for a short period.

- The water container was probably not emptied at the start of the programme. Do not wait for the empty water signal, always check and empty the container before starting a new drying programme (*see Maintenance*).

### Empty water icon is on and the water container is not full.

- This is normal. If the icon is on it is just a reminder to empty the container (*see Start and Programmes*).

### Programme finishes and clothes are damper than expected.

! For safety the dryer has a maximum programme time of 4 hours. If an automatic programme has not sensed the required final moisture in this time the dryer will complete the programme and stop. Check the above points and run the programme again, if the results are still damp, contact the Service Centre (*see Service*).

### The display shows a fault code F followed by one or two numbers

- If the display shows a fault:
  - Turn off and remove the plug. Clean the filter and the condenser unit (*see Maintenance*). Then replace the plug, turn on and start another programme. If a fault is then displayed: Note down the code and contact the Service Centre (*see Service*).

## Before calling the Service Centre:

- Use the troubleshooting guide to see if you can solve the problem yourself (*see Troubleshooting*).
- If not, turn off the dryer and call the Service Centre closest to you.

### What to tell the Service Centre:

- name, address and post code.
- telephone number.
- the type of problem.
- the date of purchase.
- the appliance model (Mod.).
- the serial number (S/N).

This information can be found on the data label inside the door of the machine.

## Spare Parts

This dryer is a complex machine. Repairing it yourself or having a non-authorised person try to repair it could cause harm to one or more persons, could damage the machine and could invalidate the spare parts warranty.

Call an authorised technician if you experience problems while using the machine.

# Recycling and Disposal Information



As part of our continued commitment to helping the environment, we reserve the right to use quality recycled components to keep down customer costs and minimise material wastage.

- Disposing of the packaging material: follow local regulations, so the packaging can be recycled.
- To minimise risk of injury to children, remove the door and plug - then cut off mains cable, flush with the appliance. Dispose of these parts separately to ensure that the appliance can no longer be plugged into a mains socket.

## Disposal of old electrical appliances

The European Directive 2012/19/EC on Waste Electrical and Electronic Equipment (WEEE), requires that old household electrical appliances must not be disposed of in the normal unsorted municipal waste stream. Old appliances must be collected separately in order to optimise the recovery and recycling of the materials they contain and reduce the impact on human health and the environment.



The crossed out "wheeled bin" symbol on the product reminds you of your obligation, that when you dispose of the appliance it must be separately collected.

Consumers should contact their local authority or retailer for information concerning the correct disposal of their old appliance.



This appliance conforms to the following EC Directives:

- 2006/95/EC (Low Voltage Equipment)
- 2004/108/EC (Electromagnetic Compatibility)





## Guarantee

### 12 months Parts and Labour Guarantee

Your appliance has the benefit of our manufacturers' guarantee, which covers the cost of breakdown repairs for twelve months from the date of purchase.

This gives you the reassurance that if, within that time, your appliance is proven to be defective because of either workmanship or materials, we will, at our discretion, either repair or replace the appliance at no cost to you.

#### The guarantee is subject to the following conditions:

- The appliance has been installed and operated correctly and in accordance with our operating and maintenance instructions.
- The appliance is only used on the electricity or gas supply printed on the rating plate.
- The appliance has been used for normal domestic purposes only.
- The appliance has not been altered, serviced, maintained, dismantled or otherwise interfered with by any person not authorised by us.
- Any repair work must be undertaken by us or our appointed agent.
- Any parts removed during repair work or any appliance that is replaced become our property.
- The appliance is used in the United Kingdom or Republic of Ireland.

#### The guarantee does not cover:

- Damage resulting from transportation, improper use, neglect or interference or as a result of improper installation.
- Replacement of any consumable item or accessory. These include but are not limited to: plugs, cables, batteries, light bulbs, fluorescent tubes and starters, covers and filters.
- Replacement of any removable parts made of glass or plastic.

THE GUARANTEE WILL NOT APPLY IF THE APPLIANCE HAS BEEN USED IN COMMERCIAL OR NON-DOMESTIC PREMISES.

#### Non-Domestic Usage Policy:

Indesit Company manufactures appliances for domestic use only. We understand that in some cases our appliances are used in commercial and/or non-domestic situations. We still provide a full 12 month manufacturers' guarantee, provided the appliance has not been:

- Accidentally damaged** - Damage that occurs suddenly as a result of an unexpected and non-deliberate external action.
- Maliciously damaged** - The deliberate and intentional damage to the product.
- Subjected to misuse** - Incorrect or careless or improper use.
- Subjected to overuse** - Excessive usage versus that expected of a domestically situated appliance.

### 5 Year Parts Guarantee

Hotpoint also offers you a FREE 5 year parts guarantee. This additional guarantee is conditional on you registering your appliance with us and the parts being fitted by one of our authorised engineers. There will be a charge for our engineer's time.

To activate the extra parts warranty on your appliance, simply call our **free phone** registration line on **0800 519 2102 (Republic of Ireland 1800 844 347)**



195108466.01 N

01/2013 - LION fpg - Four Ashes, Wolverhampton



### **Extended Guarantees**

We offer a selection of protection plans that enable you to fully cover yourself against the expense of repair bills for the life of your policy. To find the ideal plan for you please call our advice line on

**UK: 08448 226 226**

**Republic of Ireland: 01 230 0233**

### **Free Helpdesk Service**

We have a dedicated team who can provide free advice and assistance with your appliance if you experience any technical difficulties within the first 90 days of ownership. Simply call our Hotpoint Service Hotline on **08448 224 224 (Republic of Ireland 0818 313 413)** for telephone assistance, or, where necessary, to arrange for an engineer to call.

## **After Sales Service**

No one is better placed to care for your Hotpoint appliance during the course of its working life than us - the manufacturer.

## **Essential Contact Information**

### **Hotpoint Service**

We are the largest service team in the country offering you access to 400 skilled telephone advisors and 1100 fully qualified engineers on call to ensure you receive fast, reliable, local service.

**UK: 08448 224 224**

**Republic of Ireland: 0818 313 413**

**[www.hotpointservice.co.uk](http://www.hotpointservice.co.uk)**

**Please note: Our advisors will require the following information:**

Model number

Serial number

### **Parts and Accessories**

We supply a full range of genuine replacement parts as well as accessory products that protect and hygienically clean your appliance to keep it looking good and functioning efficiently throughout its life.

**UK: 08448 225 225**

**Republic of Ireland: 0818 313 413**

**[www.hotpointservice.co.uk](http://www.hotpointservice.co.uk)**

### **Appliance Registration**

We want to give you additional benefits of Hotpoint ownership. To activate your FREE 5 year parts guarantee you must register your appliance with us.

**Free phone UK: 0800 519 2102**

**Republic of Ireland: 1800 844 347**

**[www.hotpointservice.co.uk](http://www.hotpointservice.co.uk)**