

SHARP®

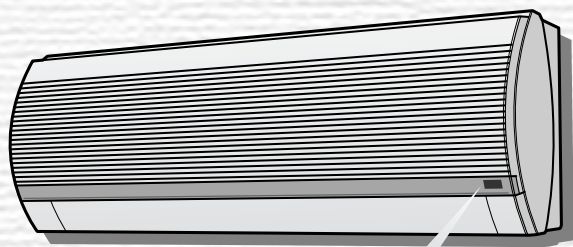

**SPLIT TYPE
ROOM AIR CONDITIONER**

OPERATION MANUAL

INDOOR UNIT

AY-AP09DJ

OUTDOOR UNIT

AE-A09DJ

Thank you for purchasing a SHARP air conditioner. Please read this manual carefully before operating the product.

CONTENTS

• PRECAUTIONS	1	• PLASMACLUSTER OPERATION	11
• ADDITIONAL NOTES ON OPERATION	3	• ONE-HOUR OFF TIMER	11
• TIPS ON SAVING ENERGY	3	• TIMER OPERATION	12
• PART NAMES	4	• AUXILIARY MODE	14
• USING THE REMOTE CONTROL	6	• MAINTENANCE	15
• TIPS ABOUT PLASMACLUSTER OPERATION	7	• BEFORE CALLING FOR SERVICE	16
• BASIC OPERATION	8	• SPECIFICATIONS	17
• ADJUSTING THE AIR FLOW DIRECTION	10		

PRECAUTIONS

WARNINGS FOR USE

- 1** This model should be installed with a fixed power cord to the meter box.
- 2** Be careful not to expose your body to the outlet air for prolonged periods. It may affect your physical condition.
- 3** When using the air conditioner for infants, children, elderly, bedridden or disabled people make sure the room temperature is suitable for those in the room.
- 4** Never insert objects into the unit. Inserting objects can result in injury due to the high speed rotation of the internal fans.
- 5** If anything abnormal with the air conditioner (eg burning smell), stop the operation immediately and turn the circuit breaker off.
- 6** This air conditioner should be installed by a licensed air conditioning contractor in accordance with AS/NZS 3000:2000 and your electricity suppliers rules.
- 7** There are local council rules regarding maximum allowable noise levels emitted by air conditioners, your licensed air conditioning contractor will advise you on the correct location of your outdoor unit.
- 8** Use only the manufacture-specified power cord for replacement. Replacement should be performed by a service centre approved by SHARP.

WARNINGS FOR INSTALLATION / REMOVAL / REPAIR

For your safety, ensure that your new air conditioner is installed by a licensed air conditioning contractor in accordance with the AUSTRALIAN/NEW ZEALAND WIRING RULES.

- Do not attempt to install/remove/repair the unit by yourself. Incorrect work will cause electric shock, water leak, fire etc. Consult a licensed air conditioning contractor for the installation/removal/repair of the unit.

PRECAUTIONS

CAUTIONS FOR USE

- 1** If a gas appliance is used in the same room as the air conditioner, ventilate the room periodically to prevent oxygen depletion.
- 2** For safety, do not touch the unit with wet hands, it may cause an electric shock.
- 3** For safety, turn the circuit breaker off when not using the unit for an extended period of time.
- 4** For safety, do not place anything on top of the outdoor unit or step on it.
- 5** This unit is designed for residential use. Do not use for other applications such as in a kennel or greenhouse to raise animals or grow plants.
- 6** Do not block the air inlets or outlets of the unit.
- 7** For safety, be sure to turn the unit off the circuit breaker before performing any maintenance or cleaning.
- 8** Do not pour water directly on the unit. Water can cause electrical shock or equipment failure.
- 9** This appliance is not intended for use by young children or infirm persons without supervision.
Young children should be supervised to ensure that they do not play with the appliance.

CAUTIONS FOR LOCATION / INSTALLATION

To ensure that your warranty is not cancelled, both the indoor/outdoor units and supply/interconnecting cables must be installed by a licensed air conditioning contractor.

- The unit is designed to operate on 230-240 VAC, 50Hz
- Do not install the unit where flammable gas may leak. It may cause a fire.

ADDITIONAL NOTES ON OPERATION

OPERATING TEMPERATURE RANGE

		INDOOR TEMP.	OUTDOOR TEMP.
COOLING	upper limit	32°C D.B. 23°C W.B.	46°C D.B. -
	lower limit	21°C D.B. 15°C W.B.	21°C D.B. -
HEATING	upper limit	27°C D.B. -	24°C D.B. 18°C W.B.
	lower limit	20°C D.B. -	-8.5°C D.B. -9.5°C W.B.

D.B. = Dry-bulb W.B. = Wet-bulb

- The built-in protective device may prevent the unit from operating when used out of this range.
- Condensation may form on the air outlet if the unit operates continuously in the COOL or DRY mode when humidity is over 80 percent.

WHEN POWER FAILURE OCCURS

This air conditioner has a memory function to store settings when a power failure occurs.

After power recovery, the unit will automatically re-start in the same settings which were active before the power failure, except for timer settings.

If the timers were set before a power failure, they will need to be re-set after power recovery.

PREHEATING FUNCTION

In the HEAT operation, the indoor fan may not start for two to five minutes after the unit is turned on to prevent cold air from blowing out of the unit.

DE-ICING FUNCTION

- When ice forms on the heat exchanger in the outdoor unit during the HEAT operation, an automatic de-icer provides heat for about 5 to 10 minutes to remove the ice. During de-icing, the inside and outside fans stop operating.
- After de-icing is completed, the unit automatically resumes operation in the HEAT mode.

HEATING EFFICIENCY

- The unit employs a heat pump that draws heat from the outside air and releases it into the room. The outside air temperature therefore greatly affects the heating efficiency.
- If the heating efficiency is reduced due to low outside temperatures, use an additional heater.
- It takes time to warm up and heat the entire room because of the forced air circulation system.

TIPS ON SAVING ENERGY

Below are some simple ways to save energy when you use your air conditioner.

SET THE CORRECT TEMPERATURE

- Setting the thermostat 1°C higher than the desired temperature in the COOL mode and 2°C lower in the HEAT mode will save approximately 10 percent in power consumption.
- Setting the temperature lower than necessary during cooling operation will result in increased power consumption.

BLOCK DIRECT SUNLIGHT AND PREVENT DRAFTS

- Blocking direct sunlight during cooling operation will reduce power consumption.
- Close the windows and doors during operation.

SET PROPER AIR FLOW DIRECTION TO OBTAIN THE BEST AIR CIRCULATION

KEEP FILTER CLEAN TO ENSURE THE MOST EFFICIENT OPERATION

MAKE MOST OF THE TIMER OFF FUNCTION





DISCONNECT THE POWER CORD WHEN THE UNIT IS NOT USED FOR AN EXTENDED PERIOD OF TIME

- The indoor unit still consumes a small amount of power when it is not operating.

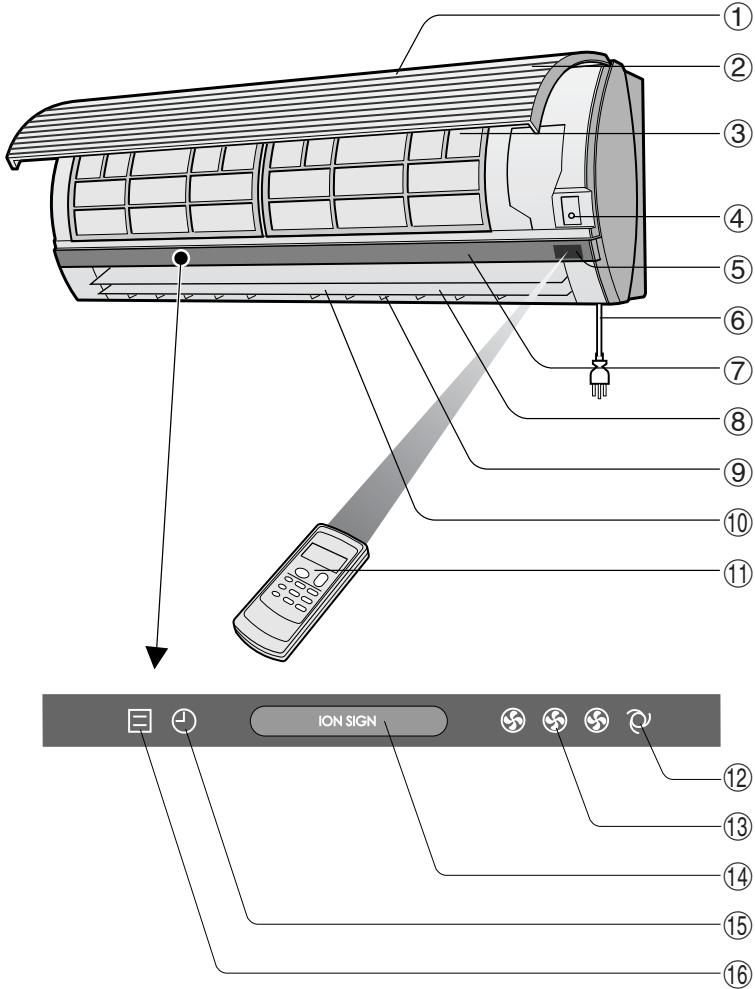
PART NAMES

INDOOR UNIT



- ① Inlet (Air)
- ② Open Panel
- ③ Air Filters
- ④ AUX. Button
- ⑤ RECEIVER Window
- ⑥ Power Supply Cord
- ⑦ Indicator Panel
- ⑧ Vertical Adjustment Louvres
- ⑨ Horizontal Adjustment Louvres
- ⑩ Outlet (Air)
- ⑪ Remote Control
- ⑫ AUTO FAN SPEED Lamp (green )
- ⑬ FAN SPEED Lamp (green )
- ⑭ PLASMACLUSTER Lamp (blue, green)
- ⑮ TIMER Lamp (orange )
- ⑯ OPERATION Lamp (red )

OUTDOOR UNIT

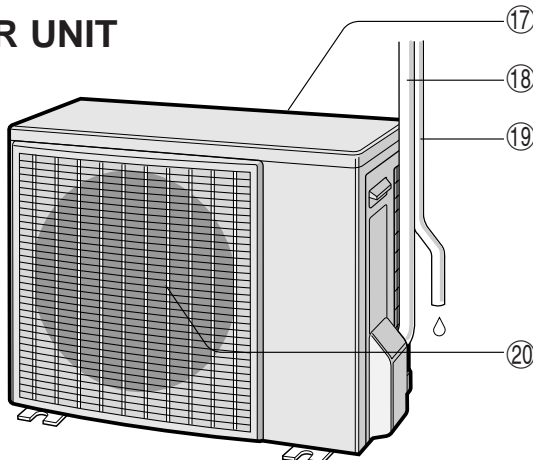

- ⑰ Inlet (Air)
- ⑱ Refrigerant Tube and Interconnecting Cord
- ⑲ Drainage Hose
- ⑳ Outlet (Air)

NOTE: Actual units might vary slightly from those shown above.

REMOTE CONTROL

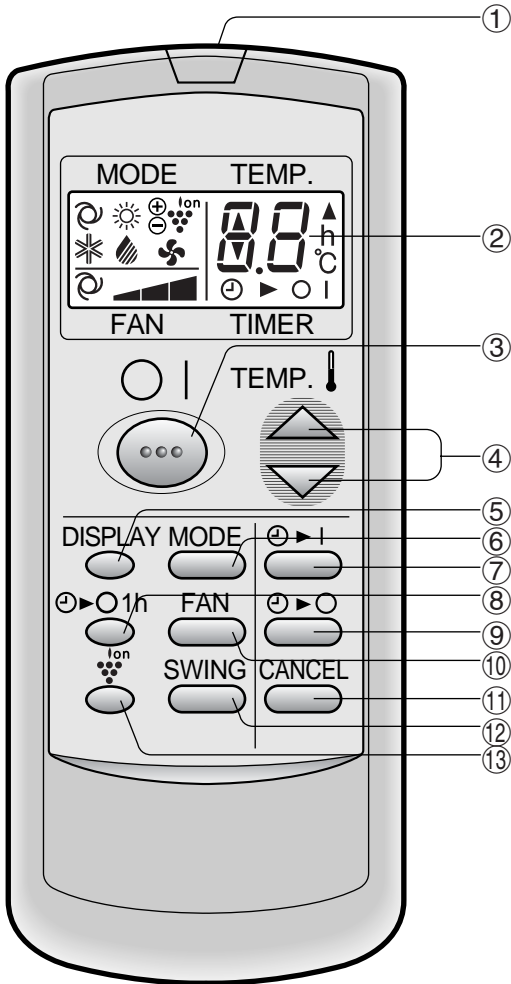

- ① TRANSMITTER
- ② DISPLAY (Liquid Crystal Display)
- ③ ON/OFF Button
- ④ THERMO. (Thermostat) Button
- ⑤ DISPLAY Button
- ⑥ MODE Button
- ⑦ TIMER ON Button (for setting the timer)
- ⑧ ONE-HOUR OFF TIMER Button
- ⑨ TIMER OFF Button (for setting the timer)
- ⑩ FAN Button
- ⑪ TIMER CANCEL Button
- ⑫ SWING Button
- ⑬ PLASMACLUSTER Button

L.C.D. REMOTE CONTROL DISPLAY

⑭ MODE SYMBOLS

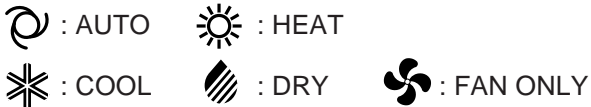

⑮ FAN SPEED SYMBOLS



⑯ PLASMACLUSTER SYMBOL

⑰ TEMPERATURE AND TIMER COUNT DOWN INDICATOR

⑱ TRANSMITTING SYMBOL

⑲ TIMER ON/TIMER OFF INDICATOR

Indicates when timer on or timer off is set.

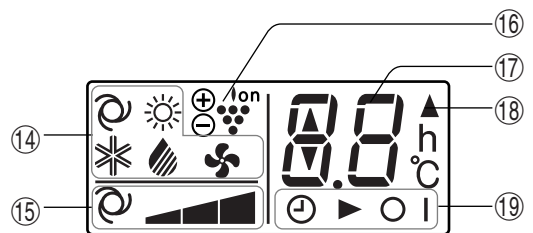

USING THE REMOTE CONTROL

LOADING BATTERIES Use two size-AAA (R03) batteries.

- 1 Remove the battery cover at the back of the remote control.
- 2 Insert batteries in the compartment, making sure the \oplus and \ominus polarities are correctly aligned.
 - Lines will be indicated on the display when batteries are properly installed.
- 3 Replace the battery cover.

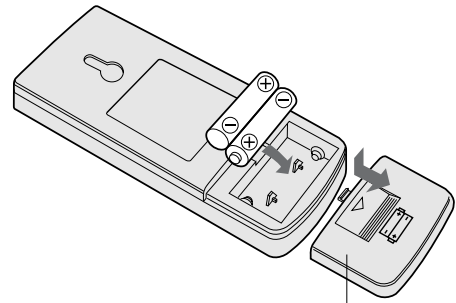

Battery cover

NOTES:

- The battery life is approximately one year in normal use.
- When you replace the batteries, always change both batteries, and make sure they are the same type.
- If the remote control does not operate properly after replacing the batteries, take out the batteries and reinstall them again after 30 seconds.
- If you will not be using the unit for a long time, remove the batteries from the remote control.

HOW TO USE THE REMOTE CONTROL

Point the remote control towards the unit's signal receiver window and press the desired button. The unit generates a beep when it receives the signal.

- Make sure there is no curtain or other object between the remote control and the unit.
- The operation range of the remote control is up to 7 metres.

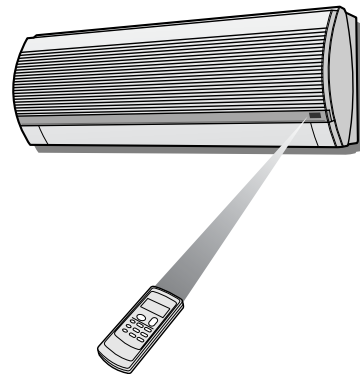

CAUTION

- Do not allow the signal receiver window to receive strong direct sunlight, since it can adversely affect its operation. If the signal receiver window is exposed to direct sunlight, close a curtain to block the light.
- Using a fluorescent lamp with a quick starter in the same room may interfere with transmission of the signal.
- The unit can be affected by signals transmitted from the remote control of a television, VCR or other equipment used in the same room.
- Do not leave the remote control in direct sunlight or near a heater. Also, protect the unit and remote control from moisture and shock which can discolour or damage them.

TIPS ABOUT PLASMACLUSTER OPERATION

The ionizer inside the air conditioner will release cluster ions, which are collective mass of positive and negative ions, into the room. The cluster ions reduce airborne mold fungus.

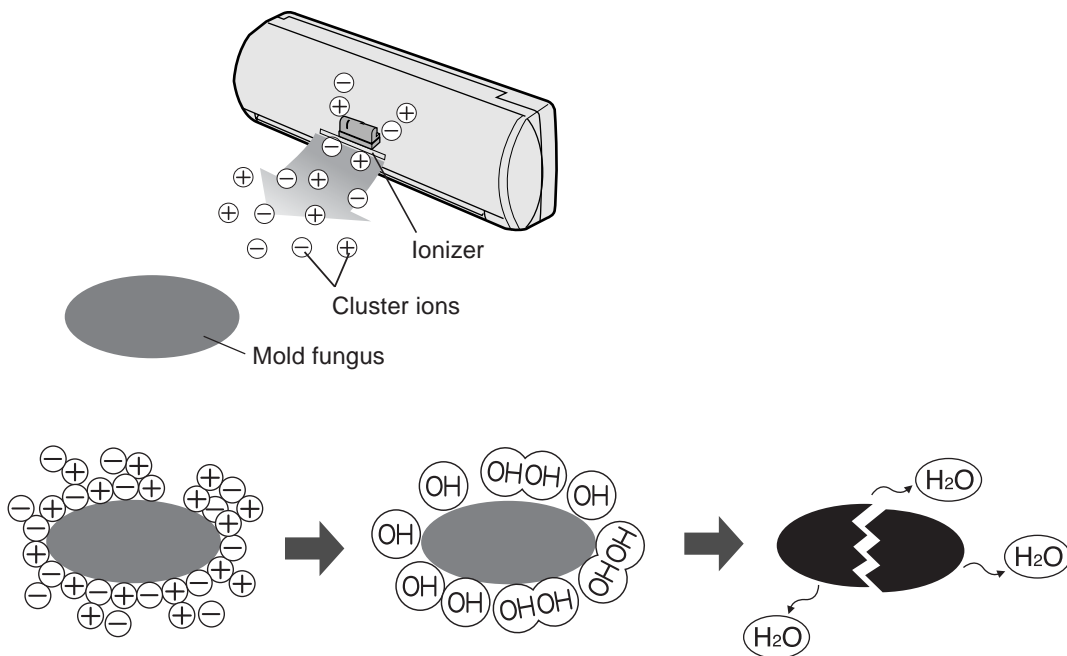

AIR CLEAN OPERATION

Cluster ions released into the air will reduce airborne mold fungus.

ION BALANCE OPERATION

It is said that plenty of negative ions exist in places such as waterfalls or waterside in natural environment. In this operation mode, negative ions will be released in an increased rate, in order to bring the room air close to this condition.

Please refer to page 11 for operation.

BASIC OPERATION

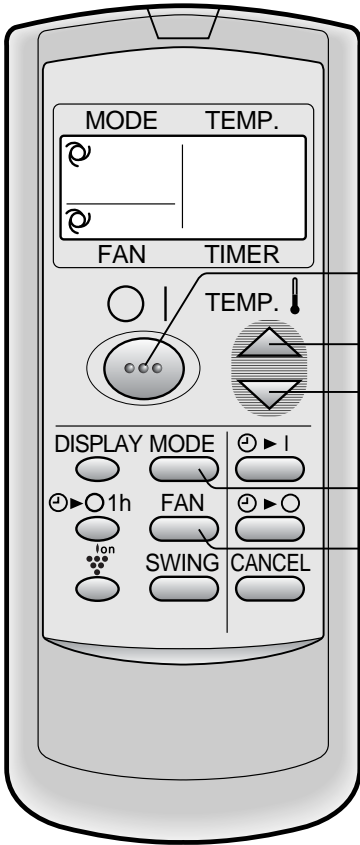

1 Press the MODE button to select the operation mode.

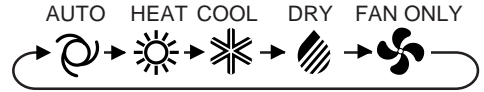

2 Press the ON/OFF button to start operation.

- The red OPERATION lamp () on the unit will light.

3 Press the THERMO. button to set the desired temperature.

AUTO/DRY MODE

The temperature can be changed in 1°C increments within the range of 2°C higher to 2°C lower from the temperature automatically determined by the air conditioner.



COOL/HEAT MODE

The temperature can be set within the range of 18 to 32°C.

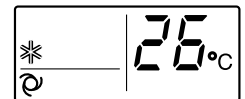

FAN ONLY MODE

The temperature setting cannot be made.

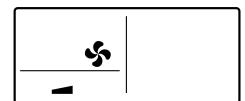

4 Press the FAN button to set the desired fan speed.



- In the DRY mode, the fan speed is pre-set to AUTO and cannot be changed.
- In the FAN ONLY mode, the fan speed cannot be set to AUTO.

5 To turn off the unit, press the ON/OFF button again.

- The red OPERATION lamp () on the unit will turn off.

TIPS ABOUT AUTO MODE

In the AUTO mode, the temperature setting and mode are automatically selected according to the room temperature when the unit is turned on.

Modes and Temperature Settings

Room temp. at operation start-up	Automatic Operation	
	Mode	Thermostat Setting
Below 21°C	HEAT	23°C
21°C-24°C	DRY	Room Temp. at start-up
24°C-26°C	COOL	24°C
26°C-28°C	COOL	25°C
Above 28°C	COOL	26°C

TIPS ABOUT FAN SPEED LAMP

During operation, the FAN SPEED Lamp will light up in 3 levels (2 levels for DRY mode) on the indicator panel of the unit to indicate the fan speed.

When fan speed is set to AUTO

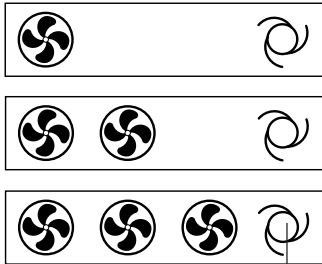

The AUTO FAN SPEED Lamp will light up.

When fan speed is set to manual

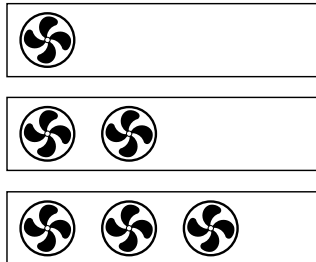

Soft speed

Low speed

High speed

To turn off the FAN SPEED Lamp, press the DISPLAY button.
The PLASMACLUSTER Lamp will also go off.

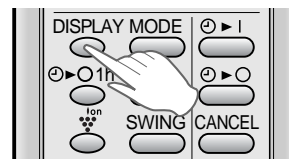

ADJUSTING THE AIR FLOW DIRECTION

VERTICAL AIR FLOW DIRECTION

The air flow direction is automatically preset in each mode as follows for optimum comfort:

COOL and DRY mode	Horizontal air flow
HEAT and FAN ONLY mode	Diagonal air flow

HOW TO ADJUST THE AIR FLOW DIRECTION

Press the SWING button on the remote control once.

- The vertical adjustment louvre will change its angle continuously.

Press the SWING button again when the vertical adjustment louvre is at the desired position.

- The louvre will stop moving within the range shown in the diagram.
- The adjusted position will be memorized and will be automatically set to the same position when operated the next time.

Adjustment range

COOL and DRY mode HEAT and FAN ONLY mode

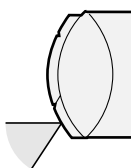

The adjustment range is narrow in order to prevent condensation from dripping.

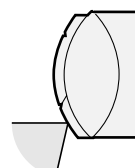

The range is wide so the air flow can be directed toward the floor.

HORIZONTAL AIR FLOW DIRECTION

Hold the horizontal adjustment louvre as shown in the diagram and adjust the air flow direction.

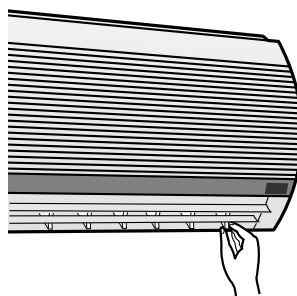

CAUTION

Never attempt to adjust the vertical adjustment louvres manually.

- Manual adjustment of the vertical adjustment louvre can cause the unit to malfunction when the remote control is used for the adjustment.
- When the vertical adjustment louvre is positioned at the lowest position in the COOL or DRY mode for an extended period of time, condensation may result.

Do not adjust the horizontal adjustment louvre extremely to the right or left when operating the air conditioner with fan speed "SOFT" for an extended period of time.

Condensation may form on the louvres.

PLASMACLUSTER OPERATION

AIR CLEAN OPERATION : Cluster ions released into air will reduce airborne mold fungus.

ION BALANCE OPERATION : Negative ions will be released in an increased rate.

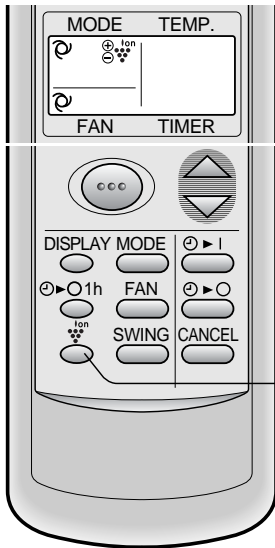

1 During operation, press the PLASMACLUSTER button to select the mode.

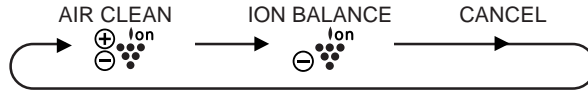

- In the AIR CLEAN operation, the blue PLASMACLUSTER lamp on the unit will light up.
- In the ION BALANCE operation, the green PLASMACLUSTER lamp on the unit will light up.

TO CANCEL

Press the PLASMACLUSTER button until PLASMACLUSTER symbol on the remote control display goes off.

- The PLASMACLUSTER lamp on the unit will turn off.

NOTE:

- Setting of the PLASMACLUSTER operation will be memorized and will operate in the same mode, the next time you turn on the air conditioner.
- To turn off the PLASMACLUSTER Lamp, press the DISPLAY button.

ONE-HOUR OFF TIMER

When the ONE-HOUR OFF TIMER is set, the unit will stop operating after one hour.

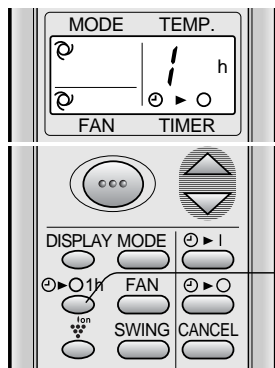

1 Press the ONE-HOUR OFF TIMER button.

- The remote control displays "1h 0▶0".
- The orange TIMER lamp (⌚) on the unit will light up.
- The unit will stop operating after one hour.

TO CANCEL

Press the CANCEL button.

- The orange TIMER lamp (⌚) on the unit will turn off.

Or, turn the unit off by pressing the ON/OFF button.

- The red OPERATION lamp (⏻) and the orange TIMER lamp (⌚) on the unit will turn off.

NOTES:

- The ONE-HOUR OFF TIMER operation has priority over TIMER ON and TIMER OFF operations.
- When the ONE-HOUR OFF TIMER is set while the unit is not operating, the unit will operate for an hour with the formerly set condition.
- If you wish to operate the unit for another hour before the ONE-HOUR OFF TIMER activates, press the ONE-HOUR OFF TIMER button again during operation.

TIMER OPERATION

TIMER OFF

The unit will turn off automatically according to your setting.

Timer duration can be set from minimum 0.5 hours (30 minutes) to maximum 12 hours.

Up to 9.5 hours, you can set by 0.5 hours (30 minutes) increments and from 10 to 12 hours, by 1 hour increment.

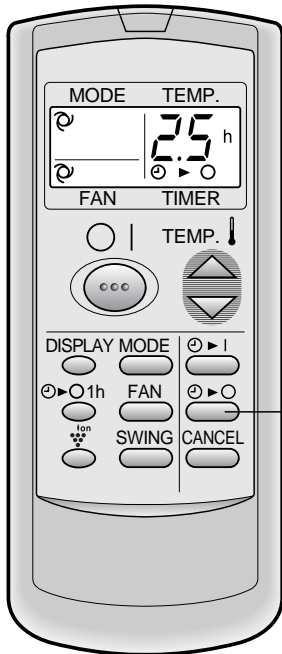

Point the remote control at the signal receiver window on the unit.

1 Press the TIMER OFF () button and set time as desired.

- The time setting will change as you press the button as follows.



Hold the button pressed down for fast setting.

- The orange TIMER lamp () on the unit will light.
- The unit will generate a beep when it receives the signal.
- The time setting will count down to show remaining time.

Example : When you wish to stop the operation 2.5 hours later.

TIPS ABOUT TIMER OFF OPERATION

When the TIMER OFF is set, the temperature setting is automatically adjusted to prevent the room from becoming excessively hot or too cold while you sleep. (Auto Sleep function)

COOL/DRY MODE:

- One hour after the timer operation begins, the temperature setting rises 1°C higher than the original thermostat setting.

HEAT MODE:

- One hour after the timer operation begins, the temperature setting drops 3°C lower than the original thermostat setting.

NOTE:

- The Auto Sleep function will not activate during the FAN ONLY mode.

TO CANCEL TIMER

Press the CANCEL button.

- The orange TIMER lamp () on the unit will turn off.

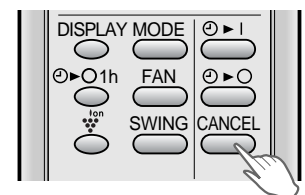

TO CHANGE TIMER SETTING

Press the TIMER button which you wish to change, (TIMER OFF or TIMER ON) and change the time setting.

TIMER ON

The unit will turn on automatically according to your setting.

Timer duration can be set from minimum 0.5 hours (30 minutes) to maximum 12 hours.

Up to 9.5 hours, you can set by 0.5 hours (30 minutes) increments and from 10 to 12 hours, by 1 hour increment.

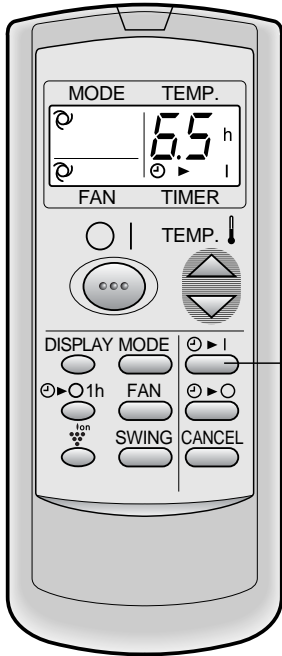

Point the remote control at the signal receiver window on the unit.

1 Press the TIMER ON () button.

- The time setting will change as you press the button as follows.

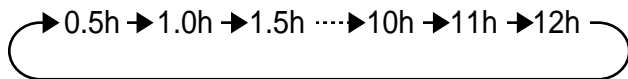

Hold the button pressed down for fast setting.

- The orange TIMER lamp () on the unit will light.
- The unit will generate a beep when it receives the signal.
- The time setting will count down to show remaining time.

Select the mode, temperature, fan speed setting and PLASMACLUSTER operation as desired.

- When the temperature is set with the TIMER ON, the temperature will show in the display for 5 seconds and then return to the time display.
- If you do not change the setting, the unit will operate with the latest setting.
- The unit will turn on prior to the set time to allow the room to reach the desired temperature by the programmed time. (Awaking function)

Example : When you wish the room temperature to be as desired 6.5 hours later.

NOTES FOR TIMER SETTING AND OPERATION

- The latest time setting will be memorized and will appear on the remote control display the next time you set the TIMER OFF or TIMER ON.
- TIMER OFF and TIMER ON can not be set together.
The latest set TIMER will be active.
- When ONE-HOUR OFF TIMER is set, TIMER OFF and TIMER ON will not be available.
- When ONE-HOUR OFF TIMER is set during TIMER OFF or TIMER ON duration, the TIMER ON or TIMER OFF will be cancelled.

AUXILIARY MODE

Use this mode when the remote control is not available.

TO TURN ON

Lift the front panel of the indoor unit and press the AUX. button on the operation panel.

- The red OPERATION lamp () on the unit will light and the unit will start operating in the AUTO mode.
- The fan speed and temperature setting are set to AUTO.

TO TURN OFF

Press the AUX. button on the operation panel again.

- The red OPERATION lamp () on the unit will turn off.

NOTE:

If the AUX. button is pressed during normal operation, the unit will turn off.



MAINTENANCE

Be sure to disconnect the power cord from the wall outlet or turn off the circuit breaker before performing any maintenance.

CLEANING THE FILTERS The air filters should be cleaned every two weeks.

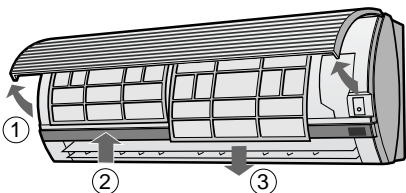

1 TURN OFF THE UNIT

2 REMOVE THE FILTERS

- ① Lift the open panel.
- ② Push the air filters up slightly to unlock them.
- ③ Pull the air filters down to remove them.

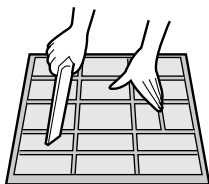

3 CLEAN THE FILTERS

Use a vacuum cleaner to remove dust. If the filters are dirty, wash them with warm water and a mild detergent. Dry filters in the shade before reinstalling.

4 REINSTALL THE FILTERS

- ① Reinstall the filters in the original positions.
- ② Close the open panel.
- ③ Push the arrow-marked of the panel firmly to lock it in place.

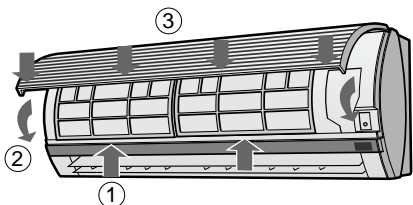

CLEANING THE UNIT AND THE REMOTE CONTROL

- Wipe them with a soft cloth.
- Do not directly splash or pour water on them. It can cause electrical shock or damage.
- Do not use hot water, thinner, abrasive powders or strong solvents.

MAINTENANCE AFTER AIR CONDITIONER SEASON

- 1 Operate the unit in the FAN ONLY mode for about half a day to allow the mechanism to thoroughly dry.
- 2 Stop the operation and unplug the unit. Turn off the circuit breaker, if you have one exclusively for the air conditioner.
- 3 Clean the filters, then reinstall them.

MAINTENANCE BEFORE AIR CONDITIONER SEASON

- 1 Make sure that the air filters are not dirty.
- 2 Make sure that nothing obstructs the air inlet or outlet.
- 3 Check the outdoor mounting rack periodically for wear and to make sure it is firmly in place.

BEFORE CALLING FOR SERVICE

The following conditions do not denote equipment malfunctions

<p>UNIT DOES NOT OPERATE The unit will not operate if it is turned on immediately after it is turned off. The unit will not operate immediately after the mode is changed. This is to protect the internal mechanisms. Wait 3 minutes before operating the unit.</p>	<p>SWISHING NOISE The soft, swishing noise is the sound of the refrigerant flowing inside the unit.</p>
<p>UNIT DOES NOT SEND OUT WARM AIR The unit is preheating or de-icing.</p>	<p>WATER VAPOUR</p> <ul style="list-style-type: none"> • In the COOL and DRY operation, water vapour can sometimes be seen at the air outlet due to the difference between the room air temperature and the air discharged by the unit. • In the HEAT operation, water vapour may flow out of the outdoor unit during de-icing.
<p>ODORS Carpet and furniture odors that entered into the unit and the air conditioner's inner component odors at the early stage of installation may be sent out from the unit.</p>	<p>ODOR EMITTED FROM THE PLASMACLUSTER AIR OUTLET This is the smell of ozone generated from the ionizer. Density of the ozone is very little, having no adverse effect over your health. The ozone released into the air will decompose soon, and its density in the room will not increase.</p>
<p>CRACKING NOISE The unit may produce a cracking noise. This sound is generated by the friction of the front panel and other components expanding or connecting due to a temperature change.</p>	
<p>A LOW BUZZ NOISE EMITTED This is a sound emitted when the unit is generating cluster ions.</p>	

If the unit appears to be malfunctioning, check the following points before calling for service.

<p>IF THE UNIT FAILS TO OPERATE</p>
<ul style="list-style-type: none"> • Check to see if the circuit breaker has tripped or the fuse has blown.

<p>IF THE UNIT FAILS TO COOL (OR HEAT) THE ROOM EFFECTIVELY</p>		
<p>Check the filters. If dirty, clean them.</p>	<p>Check the outdoor unit to make sure nothing is blocking the air inlet or outlet.</p>	<p>Check the thermostat is proper setting.</p>
<p>Make sure windows and doors are closed tightly.</p>	<p>A large number of people in the room can prevent the unit from achieving the desired temperature.</p>	<p>Check whether any heat-generating appliances are operating in the room.</p>

<p>IF THE UNIT FAILS TO RECEIVE THE REMOTE CONTROL SIGNAL</p>		
<p>Check whether the remote control batteries have become old and weak.</p>	<p>Try to send the signal again with the remote control pointed properly towards the unit's signal receiver window.</p>	<p>Check whether the remote control batteries are installed with the polarities properly aligned.</p>

Please call for service when OPERATION Lamp and TIMER Lamp on the indicator panel blink.

SPECIFICATIONS

Indoor unit	AY-AP09DJ
Outdoor unit	AE-A09DJ
Rated A.C. voltage (V)	230-240
Rated frequency (Hz)	50
Cooling capacity (kW)*	2.5
Heating capacity (kW)*	3.0

*When tested in accordance with AS/NZS3823.1.1.

SHARP CORPORATION
OSAKA, JAPAN

Printed in Thailand
TINSEA359JBRZ 03HO (TH) ①