

OWNER'S MANUAL

EURO-PRO 

**Steam Station
Model IR4005**

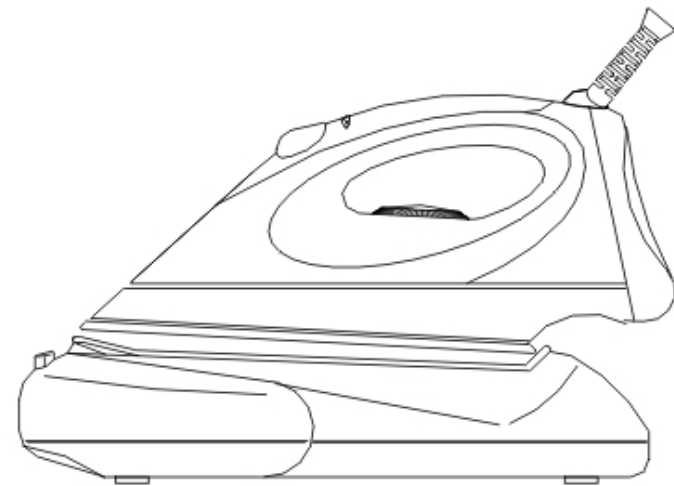

For information or assistance:

EURO-PRO Operating LLC
21 Lawrence Paquette Ind. Dr.
Champlain, NY 12919
Tel.: 800-798-7398
www.euro-pro.com

IMPORTANT SAFETY INSTRUCTIONS

When using your iron, basic safety precautions should always be followed, including the following:

1. Read all instructions carefully.
2. Use iron only for its intended use.
3. To protect against risk of electrical shock, do not immerse the iron in water or other liquids. Always turn the iron to "OFF" before plugging in or unplugging from outlet.
4. Never yank cord to disconnect from outlet. Grasp plug and pull to disconnect.
5. Do not allow cord to touch hot surfaces. Let iron cool completely before putting away.
6. Always disconnect iron from electrical outlet when filling with water, emptying, or when not in use.
7. Do not operate iron with a damaged cord, or after the iron has been dropped or damaged in any manner. To avoid the risk of electric shock, do not disassemble the iron. Send it to **EURO-PRO Operating LLC** for examination and repair. Incorrect re-assembly can cause the risk of electric shock when the iron is used.
8. Close supervision is necessary for any appliance being used by or near children. Do not leave iron unattended while connected or on an ironing board.
9. Burns can occur from touching hot metal parts, hot water or steam. Use caution when you turn a steam iron upside down; there may be hot water in the reservoir.

10. Never direct steam at any person, especially when using the iron in a vertical position. The steam is very hot and could cause burns.
11. The use of accessory attachments not recommended by **EURO-PRO Operating LLC** may result in fire, electrical shock or personal injury.
12. Do not operate in the presence of explosive and/or flammable fumes.
13. Make sure that the cord set never touches the iron soleplate when it is hot.
14. **This appliance is for household use only.**

SPECIAL INSTRUCTIONS

1. To avoid a circuit overload, do not operate another high-wattage appliance on the same circuit.
2. If an extension cord is absolutely necessary, use a 13-ampere cord. Cords rated for less amperage may overheat. Use care to arrange the cord so that it cannot be pulled or tripped over.

WARNING: Water must first be pumped (look for pump light to be illuminated) from the water tank to the iron before steam will exit: water requires approximately 2 minutes to pass through the hose and reach the iron. Once this is done, you will not have to wait again - you will have continuous steam (if you keep pump on). Please note though that you must also adjust variable steam to desired output level or steam will not exit the iron.

POLARIZED PLUG: This appliance has a polarized plug (one blade is wider than the other). As a safety feature, this plug will fit into a polarized outlet only one way. If the plug does not fit fully into the outlet, reverse the plug. If it still does not fit, contact a qualified electrician. Do no attempt to defeat this safety feature.

SAVE THESE INSTRUCTIONS

For Household Use Only

Model IR4005

LIMITED WARRANTY

EURO-PRO Operating LLC warrants this product to be free from defects in material and workmanship for a period of one (1) year from the date of purchase. The liability of **EURO-PRO Operating LLC** is limited solely to the repair or replacement of the product at it's option. This warranty does not cover damage caused by misuse, negligence, use on improper current or voltage, use contrary to operating instructions or disassembly, repair or alteration by any person other than **EURO-PRO Operating LLC**.

Product repair or replacement, at our option, is your sole remedy. This warranty excludes all other legal and/or conventional warranties. The responsibility of **EURO-PRO Operating LLC**, if any, is limited to the specific obligations expressly assumed by it under the terms of the limited warranty. In no event is **EURO-PRO Operating LLC** liable for incidental or consequential damages of any nature whatsoever. Some States do not permit the exclusion or limitation of incidental or consequential damages, so the above may not apply to you. This warranty gives you specific legal rights which vary from state to state.

If you have a claim under this warranty or if you require service
DO NOT RETURN THIS PRODUCT TO THE STORE!

Send the product, postage prepaid to:

In U.S.A.: **EURO-PRO Operating LLC**
21 Lawrence Paquette Ind. Dr.
Champlain, NY 12919
Tel: (800) 798-7398

Please include a copy of your sales receipt, \$9.50 to over the cost of return shipping & handling and a letter explaining the nature of your difficulty. Do not forget to enclose your name, address and telephone number.

If the warranty period has expired, please send your iron postage pre-paid to:

In U.S.A.: Service Department
EURO-PRO Operating LLC
21 Lawrence Paquette Ind. Dr.
Champlain, NY 12919
Tel: (800) 798-7398

You will be advised of the cost of repair before any servicing is done unless you enclose a note indicating that you would like us to proceed with the repairs and return the iron to you C.O.D.



PRODUCT REGISTRATION CARD

Please complete and return within ten (10) days of purchase. The registration will enable us to contact you in the event a product defect is discovered. By returning this card you acknowledge to have read and understood the instructions for use, and warnings set forth in the accompanying instructions.

RETURN TO: **EURO-PRO Operating LLC**, 21 Lawrence Paquette Ind. Dr., CHAMPLAIN, N.Y. 12919

PURCHASER:

ADDRESS:

DATE OF PURCHASE: MODEL **Model IR4005** SERIAL NO:

NAME AND ADDRESS OF STORE:

TROUBLESHOOTING

PROBLEM	POSSIBLE REASONS & SOLUTIONS
Iron does not heat	<ul style="list-style-type: none"> • Iron should be plugged into a 120V AC electrical outlet only. Make sure that the plug is securely in the socket. • Temperature setting too low. Turn to higher setting. • Iron not properly placed in stand.
Thermostat ready light goes On and Off	<ul style="list-style-type: none"> • This is normal. The light goes On and Off as the thermostat is switching the heating element On and Off to maintain the selected temperature.
Some odor or small particles come out of steam vents of new iron	<ul style="list-style-type: none"> • This is normal. Follow instructions for first use and allow iron to steam through 2-3 fillings & press the steam burst button occasionally to eliminate small white particles.
Iron does not steam	<ul style="list-style-type: none"> • Water tank may be empty or water level is very low. Add water. • Make sure that the temperature control dial is correctly set. For maximum steam, temperature control dial should be set on '***'. • Make sure the temperature control dial is set in the correct steam area, e.g. '•', for more steam, turn temperature dial to higher setting, e.g. '***'. • If temperature setting is correct and there is no steam, <u>gently</u> tap the soleplate on the ironing board a few times.
Water droplets coming from steam vents	<ul style="list-style-type: none"> • Iron may not be hot enough. Set temperature control dial to the 'Max' position. Always allow iron sufficient time to heat up (thermostat light goes off) before pressing the steam button. • Overuse of steam burst. Allow more time between each burst. • Iron may have been overfilled. Turn iron off, empty water and follow instructions for filling. • Steam performance may be low if iron requires seasoning. To season, use regular tap water for 1 or 2 tanks until steam performance improves.

ADDITIONAL IMPORTANT SAFEGUARDS

1. Your Steam Station iron is designed to rest only on the iron rest provided with the iron. Do not rest iron on soleplate.
 2. Never use or rest iron on an unstable surface.
 3. While the iron is hot, never set iron on an unprotected surface - even if it is on its heel rest.
 4. **WARNING! TO PREVENT ELECTRIC SHOCK OR OTHER INJURY, before filling the iron with water, make sure that the plug is removed from the outlet.**
 5. **CAUTION: Never fill the iron with fabric conditioner, starches or any other solution, as these will damage the steam mechanism. Do not use contaminated water.**
 6. **WARNING! TO AVOID FIRE, never leave iron unattended while it is plugged in.**
 7. **WARNING! TO PREVENT ELECTRIC SHOCK, never immerse the iron in water or other liquid.**
 8. **WARNING! TO PREVENT ELECTRIC SHOCK, never use the iron in a location where it can fall or be pulled into water or any other liquid. If the iron falls into water or any other liquid, unplug it immediately. DO NOT reach into the water or liquid.**
 9. **CAUTION: Never use scouring pads, abrasive or chemical cleaners, or solvents to clean the exterior or soleplate of your iron. Doing so will scratch and/or damage the surface.**
 10. **WARNING! DO NOT aim iron at face, towards yourself, or anyone else while using or adjusting steam. Burns or serious injury may occur.**
 11. Always store your iron on the iron rest provided with your iron, not on the soleplate. If stored face down, even the smallest amount of moisture will cause the soleplate to corrode and stain.
- 12. DANGER! Never use the iron if it is damaged or dropped. Using the iron when it is damaged could create the risks of fire, electric shock, injury or death.**

GETTING TO KNOW YOUR STEAM STATION IRON

Before using your Steam Station Iron, remove any labels, stickers or tags that may be attached to the body or soleplate of the iron.

When turned on for the first time, your new iron may emit an odor for up to 10 minutes. This is due to the initial heating of the materials used in making the iron.

The odor is safe and should not reoccur after initial heating.

Also, before ironing with steam for the first time, allow iron to heat, hold in a horizontal position and hit the steam button several times. The iron may emit some small particles from the steam holes. This is normal and will clear after pressing the steam button several times.

1. Temperature Control Dial (Rotate Dial)
2. Steam Button
3. Temperature Pilot Light
4. Iron Stand
5. Water Tank
6. Water Filling Hole
7. Rubber Mat
8. Power Cord
9. Connecting Hose/Supply Hose
10. Anti-Calc Cassette
11. Water Tank Lock
12. Pump "On" Light

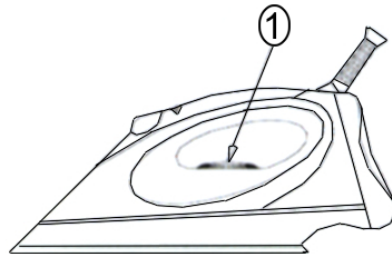
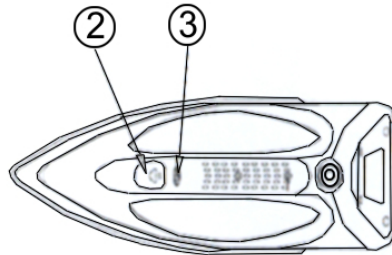

Technical Specifications

Voltage: 120V., 60Hz.
Power: 1400 Watts

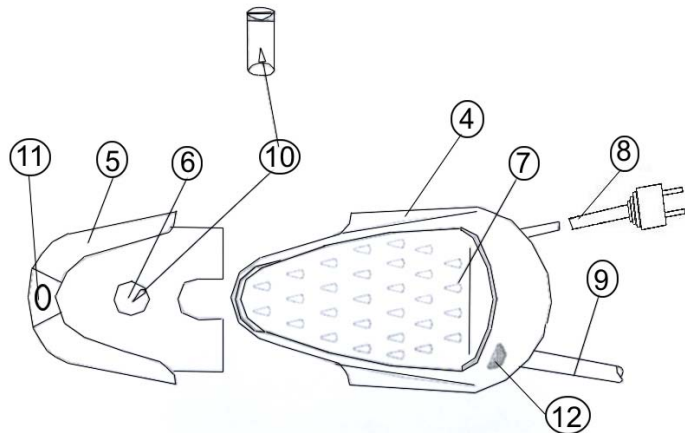

USER MAINTENANCE INSTRUCTIONS

Cleaning the Iron

1. Unplug the steam station from the electrical outlet
2. When finished using the iron, turn the temperature control dial to "MIN".
3. Allow the iron to cool down before cleaning.
4. Scale and other deposits can be wiped off the soleplate with a damp cloth and some non-scratching (fluid) abrasive.
5. Keep the soleplate smooth, avoid hard contact with metal objects.
6. From time to time, clean the inside of the water tank by filling with water and shaking.

Storage

- Remove the power cord from the wall outlet.
- Pour any remaining water out of the water tank.
- Set the steam control to position "0".
- Put the iron on the rubber mat on its stand and let cool down sufficiently before you store it.
- Regularly check if the power cord is still in a good and safe condition.

HOW TO REPLACE THE "ANTI-CALC" CASSETTE

- The "Anti-Calc" cassette should be replaced after 9-12 months of usage depending on the amount of usage and water hardness.
- Rotate and release the head of the cassette, then take it out.
- Empty the water from the water tank and cassette housing.
- Fill the water tank with water.
- Insert the new cassette and lock it into the water filling hole.
- Push steam button for about one minute. The new cassette is now filled with water.
- You can resume ironing.

To order additional "Anti-Calc" cassettes or for customer service:

Call Customer Service

In US.: 800-798-7398

Monday to Friday 8:30 AM – 5:00 PM Eastern Standard Time

or visit our website at: www.euro-pro.com

OPERATING INSTRUCTIONS (CONT.)

Ironing With Steam

Always read garment labels and follow the manufacturer's ironing instructions. Refer to the "Ironing Chart" on page 6 for temperature recommendations:

- Use low settings for synthetics and silks.
- Use moderate settings for wool and blends.
- Use high settings for cottons and linens.
- Make sure that the steam station is plugged into the electrical outlet.
- Set the temperature dial to the desired temperature. (Fig. 4)
- Fill the water tank with water, following the instructions on page 5 for filling the water tank.
- Make sure that the iron is resting on top of the rubber mat on the water tank/stand.
- When steam is desired, simply push the steam button.

Important: Do **NOT** remove rubber mat from water tank and place on a table or any other surface which may be damaged by heat.

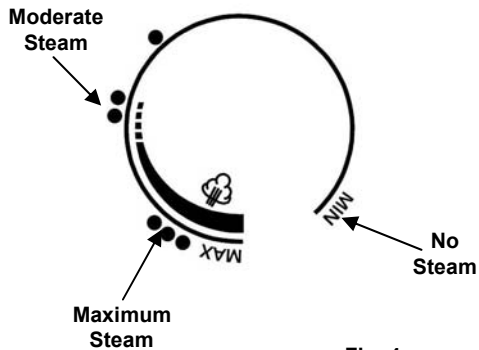

Fig. 4

Important: Make sure that the iron has reached the selected temperature before using steam.

Steaming in a Vertical Position

For vertical steaming, simply lift the iron in a vertical position and press the steam button. (See fig. 5)

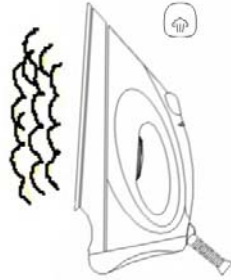

Fig. 5

Ironing With No Steam

All marked settings on the temperature control dial can be used for dry ironing.

1. Plug the cord into a polarized, 120V AC electrical outlet. The Temperature Pilot light will come on, indicating that the iron is receiving power.
2. Turn temperature dial to "MIN".
3. Turn the temperature control dial to the desired setting. (See "Ironing Chart" for a guide to temperature selection.)
4. Place iron on its rubber mat on the water tank while iron is warming to desired temperature.
5. When the temperature pilot light goes, the iron is ready for ironing.

OPERATING INSTRUCTIONS

Before First Use

Remove any labels, stickers or tags which may be attached to the body or the soleplate of the iron before using the iron.

Read all instructions carefully. Always follow the Important Safeguards.

Important: The first time an iron is used, some odor and small white particles may come out of the steam vents. This is perfectly normal and will cease to occur after the iron has been in use for a short while. Before you start using your iron, follow the instructions in manual and do the following in order to eliminate any odor and small white residue particles and to ensure optimum steam performance.

How the Water is Pumped to the Iron

1. The water is pumped from the water tank to the iron through the supply hose by a built-in water pump.
 2. This water pump is activated by pushing on the steam button. The water pump pilot light will go on.
 3. The water pump will stay activated as long as your finger pushes the steam button.
- Fill the water tank according to instructions on filling (see page 5).
 - Set the temperature control dial to its highest level.
 - When the "Temperature Pilot Light" goes off, indicating that the iron has reached its selected temperature,

Then

- Push the steam button to activate the internal water pump.
- Steam will come out after about 2 minutes. Please be patient for the first usage after which there will be no further waiting.
- Iron on a piece of cloth / towel for 2 minutes.
- Place the iron on the rubber mat and allow it to steam for 5 minutes.

Rubber Mat

Please note that during transportation, the rubber mat may come off its place.

- The iron stand has 5 holes on the circumference of its top.
- The rubber mat has 5 pins in the corresponding locations.
- Place the rubber mat on top of the iron stand and push each individual pin into its hole.

Important: Never place the hot iron on the plastic iron stand without the rubber mat on top of the iron stand. (See fig. 1)

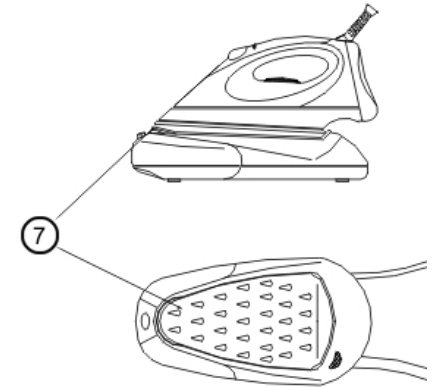

fig. 1

- Do not place the rubber mat alone on a table or any other surface which may be damaged by heat.

OPERATING INSTRUCTIONS (CONT.)

Filling the Water Tank

Steam irons should be used with tap water up to 3 mmol/l alkaline earth ions (check the degree of hardness of your water with your local water authority) or a mixture of distilled/demineralized water with tap water.

If your tap water is very hard, you can mix 1:1 distilled / demineralized water with mineral water so that your steam performance will be good.

Never use water containing additives, battery top-up water from service stations, water from household softening systems or descaling agents.

Distilled/Demineralized Water:

This should normally be mixed 1:1 with tap water. The use of pure distilled/demineralized water creates difficulties with steam production and can cause water to escape through the soleplate (formation of drops).

Note: If water escapes through the soleplate while you are using distilled/demineralized water, we recommend you use tap water 3 or 4 times.

Water with Additives:

Starch, conditioner, perfume and fabric conditioner should never be added to the water. These result in residues in the steam chamber which will damage your iron and stain your laundry. For this reason, no condensed water (water from driers may be used, as this can contain additives (e.g. conditioner).

Descaling the Iron:

Do not use chemical descaling agents as these can cause damage to the iron and stain your laundry.

Water From Household Water

Softening Systems:

Do not use water from household water softening systems because even though these systems remove calcium from the water, they add other substances to it. Therefore this water is not suitable for steam irons.

Filling the Water Tank

1. Push down the water tank lock.
2. Slide out the water tank from under the iron stand. (Fig. 2)
3. Rotate slightly the top of the "Anti-Calc" Cassette and pull it out of the water tank.
4. Fill the water tank up to the "Max" mark, as shown below in fig. 3.

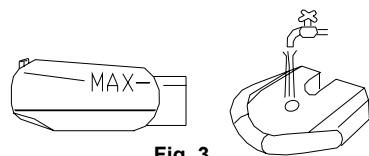
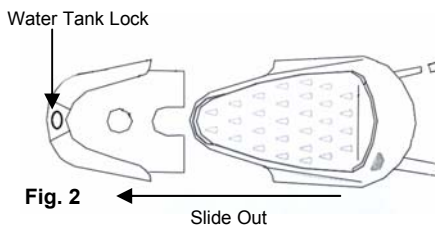

5. Return the water tank to its place, under the iron stand.

Note: Make sure that the water tank is pushed back to its place and the lock is closed. If the water tank is **not** in its place, it will not be able to deliver water from the pump to the iron.

Setting the Ironing Temperature

- Place the iron on the rubber mat on the water tank.
- Plug the power cord into the electrical outlet.
- Select the required temperature setting on the temperature control dial using the Ironing Chart on page 6.
- The temperature pilot light will come "On" indicating that the iron is heating up.
- When the temperature pilot light has gone "Off", the set temperature has been reached and the iron is ready for use.

IRONING CHART

NOTE: Before starting to iron delicate fabrics, it is best to first test the temperature of the iron on a hem or an inside seam.

To select iron temperature, align temperature selected on dial with the indicator on the water tank.

DIRECTIONS ON LABEL					
FABRIC		Synthetic fibers, e.g. acryl, viscose, polyamide (nylon), polyester SILK	WOOL	COTTON LINEN	Please note that in the label means "THIS ARTICLE CANNOT BE IRONED!"
TEMP. CONTROL		•	• •	MAX • • •	
STEAM BUTTON					

Ironing Temperature

Always check first to see whether a label with ironing instructions is attached to the article to be ironed. (See table above.) Follow these ironing instructions in all cases. If ironing instructions are missing, but you do know the kind of fabric, then see the table. The table is valid for the materials only and is not applicable to any applied finish, gloss, etc... Fabric to which some kind of finish has been applied (gloss, wrinkles, relief, etc.) can be ironed at the lowest temperature such as those made of synthetic fibers. Sort the laundry out according to ironing temperature first: wool with wool, cotton with cotton, etc...

The iron heats up quicker than it cools down. Therefore, start ironing the articles requiring the lowest temperature such as those made of synthetic fibers. If the fabric consists of various kinds of fibers, you must always select the lowest ironing temperature of the composition of those fibers. (For example: an article consisting of "60% polyester and 40% cotton" should be ironed at the temperature indicated for polyester (•) and without steam.)

If you do not know what kind(s) of fabric(s) the article has been made of, find a spot which will be invisible when wearing or using the article. Try out the ironing temperature which is most suitable there. (Start at a relatively low temperature.) Pure woollen fabrics (100% wool) may be pressed with the iron set to a steam position. Preferable set the steam control to maximum position and use a dry pressing cloth. When steam-ironing woollen fabrics, shining of the fabric may occur. This can be prevented by turning the article inside out and ironing the reverse side. Velvet and other textures which rapidly acquire shiny spots should be ironed in one direction only (with the nap) applying light pressure. Always keep the iron moving.

Iron the reverse side of synthetic materials and silk to prevent shining spots. Do not use the spray button to prevent stains.