



**24/48-Port 10/100Mbps
+ 4G TP/SFP Combo
Managed Ethernet Switch**

WGSW-2840/WGSW-5240

User's Manual

Trademarks

Copyright © PLANET Technology Corp. 2005.

Contents subject to which revision without prior notice.

PLANET is a registered trademark of PLANET Technology Corp. All other trademarks belong to their respective owners.

Disclaimer

PLANET Technology does not warrant that the hardware will work properly in all environments and applications, and makes no warranty and representation, either implied or expressed, with respect to the quality, performance, merchantability, or fitness for a particular purpose.

PLANET has made every effort to ensure that this User's Manual is accurate; PLANET disclaims liability for any inaccuracies or omissions that may have occurred.

Information in this User's Manual is subject to change without notice and does not represent a commitment on the part of PLANET. PLANET assumes no responsibility for any inaccuracies that may be contained in this User's Manual. PLANET makes no commitment to update or keep current the information in this User's Manual, and reserves the right to make improvements to this User's Manual and/or to the products described in this User's Manual, at any time without notice.

If you find information in this manual that is incorrect, misleading, or incomplete, we would appreciate your comments and suggestions.

FCC Warning

This equipment has been tested and found to comply with the limits for a Class A digital device, pursuant to Part 15 of the FCC Rules. These limits are designed to provide reasonable protection against harmful interference when the equipment is operated in a commercial environment. This equipment generates, uses, and can radiate radio frequency energy and, if not installed and used in accordance with the Instruction manual, may cause harmful interference to radio communications. Operation of this equipment in a residential area is likely to cause harmful interference in which case the user will be required to correct the interference at whose own expense.

CE Mark Warning

This is a Class A product. In a domestic environment, this product may cause radio interference, in which case the user may be required to take adequate measures.

WEEE Warning



To avoid the potential effects on the environment and human health as a result of the presence of hazardous substances in electrical and electronic equipment, end users of electrical and electronic equipment should understand the meaning of the crossed-out wheeled bin symbol. Do not dispose of WEEE as unsorted municipal waste and have to collect such WEEE separately.

Revision

PLANET Ethernet Switch User's Manual

FOR MODELS: WGSW-2840, WGSW-5240

Part No. 2081-A92310-000

Table of Contents

1. INTRODUCTION	5
1.1 PACKET CONTENTS.....	5
1.2 HOW TO USE THIS MANUAL.....	5
1.3 PRODUCT FEATURE	5
1.4 PRODUCT SPECIFICATION.....	6
2. INSTALLATION	8
2.1 PRODUCT DESCRIPTION.....	8
2.1.1 <i>Product Overview</i>	8
2.1.2 <i>Switch Front Panel</i>	8
2.1.3 <i>LED Indications</i>	9
2.1.4 <i>Switch Rear Panel</i>	9
2.2 INSTALL THE SWITCH.....	9
2.2.1 <i>Desktop Installation</i>	10
2.2.2 <i>Rack Mounting</i>	10
3. CONSOLE MANAGEMENT	12
3.1 CONNECTING TO THE SWITCH.....	12
3.2 LOGIN IN THE CONSOLE INTERFACE	12
3.3 CONSOLE MANAGEMENT.....	13
3.4 TELNET LOGIN	14
3.5 COMMANDS	14
3.5.1 <i>First level commands</i>	14
3.5.2 <i>Privileged Command</i>	15
4. WEB-BASED MANAGEMENT	20
4.1 ABOUT WEB-BASED MANAGEMENT	20
4.2 PREPARING FOR WEB MANAGEMENT	20
4.3 SYSTEM LOGIN	20
4.4 SYSTEM	21
4.4.1 <i>IP Configuration</i>	21
4.4.2 <i>SNMP</i>	22
4.4.2.1 <i>Theory</i>	22
4.4.3 <i>Password</i>	26
4.4.4 <i>CONSOLE</i>	26
4.4.5 <i>System Upgrade</i>	26
4.4.6 <i>Saving Parameters</i>	27
4.4.7 <i>Parameters Backup & Recovery</i>	27

4.4.8 Load Default.....	28
4.4.9 Reboot	28
4.5 PORT MANAGEMENT	29
4.5.1 Port Configuration.....	29
4.5.2 Port Statistics	29
4.5.3 Port Band Restrict.....	30
4.6 REDUNDANCY	31
4.6.1 Spanning Tree.....	31
4.6.2 Spanning Tree Configuration	37
4.6.3 Link Aggregation	38
4.7 SECURITY.....	39
4.7.1 VLAN.....	39
4.7.2 MAC Address Bind.....	48
4.7.3 MAC Address Filtering	49
4.7.4 MAC Address Learning.....	50
4.7.5 MAC Address Aging Time.....	51
4.8 QoS	52
4.8.1 Understand QOS	52
4.8.2 QOS Configuration.....	53
4.9 MULTICAST	58
4.9.1 IGMP Snooping.....	58
4.9.2 Static Routing Port.....	60
4.10 PORT ANALYSIS	60
4.10.1 Port Analysis	60
4.10.2 Port Mirror	61
4.11 STORM CONTROL.....	62
5. TROUBLE SHOOTING	63
5.1 INCORRECT CONNECTIONS	63
5.1.1 Faulty or loose cables.....	63
5.1.2 Non-standard cables.....	63
5.1.3 Improper Network Topologies	63
5.2 DIAGNOSING LED INDICATORS	63
5.2.1 Cabling.....	64
6. APPENDIX	65
6.1 CONSOLE PORT PIN ASSIGNMENTS	65
6.2 100BASE-TX/10BASE-T PIN ASSIGNMENTS.....	66

1. INTRODUCTION

1.1 Packet Contents

Check the contents of your package for following parts:

- Ethernet Switch x1
- CD-ROM user's manual x1
- Quick installation guide x1
- 19" rack mounting kit x1
- Power cord x1
- Rubber feet x 4

If any of these are missing or damaged, please contact your dealer immediately, if possible, retain the carton including the original packing material, and use them against to repack the product in case there is a need to return it to us for repair.

1.2 How to Use This Manual

This User Manual is structured as follows:

Chapter 2, **INSTALLATION**

The chapter explains the functions of the Switch and how to physically install the Switch.

Chapter 3, **CONSOLE MANAGEMENT**

The chapter explains how to manage the switch by Console interface.

Chapter 4, **WEB-BASED MANAGEMENT**

The chapter explains how to manage the switch by Web interface.

Chapter 5, **TROUBLE SHOOTING**

The chapter explains how to trouble shooting of the Switch.

Chapter 6, **APPENDIX**

The chapter contains cable information of the Switch.

In the following section, terms "**SWITCH**" with upper case denotes the WGSW-2840/WGSW-5240

Ethernet switch. Terms with lower case "switch" means any Ethernet switches.

1.3 Product Feature

- 24/48-Port 10/100Mbps TP interfaces
- 4G TP/SFP combo interface
- Complies with IEEE802.3, 10Base-T, IEEE802.3u, 100Base-Tx, IEEE 802.3ab 1000Base-T,

- IEEE 802.3z 1000Base-LX/SX Ethernet standards
- High back-plane bandwidth 12.8/17.6Gbps
- Console/Web/SNMP management.
- Configuration backup and recovery.
- Per port Ingress/Egress bandwidth restriction.
- Configurable spanning tree aging time, STP port configuration.
- 12 trunk groups, up to 8 ports per trunk.
- Port-based/802.1Q VLAN with 4K VLAN ID.
- MAC Binding/Filtering/Learning, configurable MAC Aging time.
- 8 mappings ID to 4 priority queues, Support MAC/LAN/802.1p/Port to CoS mapping.
- IGMP snooping and IGMP Query mode for Multi-media application
- Statistic Routing Port.
- 1 to many Ingress/Egress Port mirror and Port analysis
- Broadcast/Multicast/Flooded storm control.

1.4 Product Specification

Model	WGSW-2840	WGSW-5240
Hardware Specification		
Network Connector	24-Port RJ-45 for 10/100Base-TX 4-Port Gigabit TP/SFP mini-GBIC combo interfaces	48-Port RJ-45 for 10/100Base-TX
RS-232 connector	One RS-232 DB-9 male connector for switch management	
Switch architecture	Store and forward switch architecture.	
Switch Fabric	Back-plan up to 12.8/17.6Gbps	
MAC address	8K MAC address table with Auto learning function	
Shared Buffer	4Mbit	7Mbit
Power requirement	90~240V AC, 50/60Hz,	
Operating environment	0~50 degree C, 5%~90%RH	
Storage environment	-20~70 degree C, 5%~90%RH	
Dimension (W x D x H)	440 x 248 x 44 mm	440 x 280 x 44 mm
Switch Specification		
Spanning Tree	802.1d, 802.1w	
Link Aggregation	12 groups, up to 8 ports per group	
Priority Queue	802.1p Class of Service (4 Queues)	
Port Mirror	RX/TX/Both	
Bandwidth Control	Yes, per port per 64kbps, up to 80Mbps	
Strom Control	Per 64kbps, up to 80Mbps	
IGMP Snooping	v1, v2	
MAC Filtering	Yes	
VLAN	Port-Based/ 802.1q, 4K VLAN ID, 256 groups	
Port Analysis	Yes	
Static Routing Port	Yes	
Management Function		

Management Interface	Console/Web/Telnet/SNMP
SNMP Version	v1, v2c
Support MIB	Support SNMP MIB (RFC 1213), Bridge MIB (RFC 1493), RMON group 1,2,3,9 Enterprise private MIB
Standard Compliance	
Network Standard	IEEE802.3 10Base-T IEEE802.3u 100Base-TX IEEE802.3z Gigabit SX/LX IEEE802.3ab Gigabit 1000Base-T IEEE802.3x Flow Control and Back pressure IEEE802.3ad Port trunk with LACP IEEE802.1d Spanning tree protocol IEEE802.1w Rapid Spanning Tree IEEE802.1p Class of service IEEE802.1Q VLAN Tagging
EMI	FCC Class A, CE

2. INSTALLATION

This section describes the functionalities of the Switch's components and guides how to install it on the desktop or shelf. Basic knowledge of networking is assumed. Please read this chapter completely before continuing.

2.1 Product Description

2.1.1 Product Overview

The PLANET WGSW-2840/5240 is a 24/48-Port 10/100Mbps fast Ethernet Switch with 4-Port Gigabit TP/SFP Combo interface which boasts a high performance switch architecture that is capable of providing non-blocking switch fabric and wire-speed throughput as high as 12.8/17.6Gbps. Its four built-in GbE uplink ports also offer incredible extensibility, flexibility and connectivity to the Core switch or Servers.

The IEEE 802 standard-based firmware provides a rich set of features and ensures interoperability with equipment from other vendors. Additionally, the firmware includes advanced features such as IGMP snooping, broadcast storm control, and MAC address filtering, to enhance security and bandwidth utilization.

With its built-in web-based management, the PLANET WGSW-2840/WGSW-5240 offers an easy-to-use, platform-independent management and configuration facility. The PLANET WGSW-2840/WGSW-5240 supports standard Simple Network Management Protocol (SNMP) and can be managed via any standard-based management software. For text-based management, the WGSW-2840/WGSW-5240 can also be accessed via Telnet and the console port.

2.1.2 Switch Front Panel

Figure 2-1 shows the front panel of the switch.

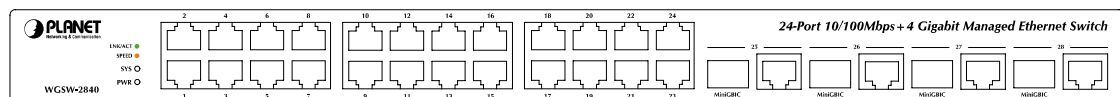

Figure 2-1 WGSW-2840 front panel.

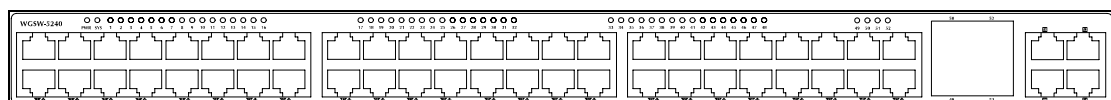

Figure 2-2 WGSW-5240 front panel

2.1.3 LED Indications

WGSW-2840:

LED	Color	Function
PWR	Green	Lights to indicate that the Switch is powered on.
SYS	Green	Lights to indicate the system is working.
LNK/ACT	Green	Blink to indicate that the switch is actively sending or receiving data over that port.
Speed	Orange	Lights to indicate the link through that port is successfully established.

WGSW-5240:

LED	Color	Function
PWR	Green	Lights to indicate that the Switch is powered on.
SYS	Green	Lights to indicate the system is working.
LNK/ACT	Green	Lights to indicate the port is linked. Blinks to indicate that the switch is actively sending or receiving data over that port.

2.1.4 Switch Rear Panel

Figure 2-2 shows the rear panel of the switch



Figure 2-3 WGSW-2840 rear panel

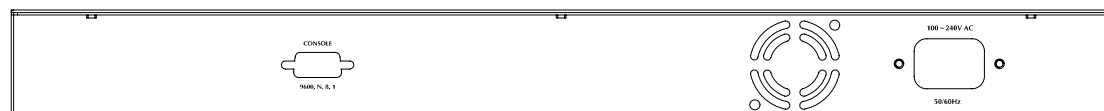

Figure 2-4 WGSW-5240 rear panel

Power Notice:

1. The device is a power-required device, it means, it will not work till it is powered. If your networks should active all the time, please consider using UPS (Uninterrupted Power Supply) for your device. It will prevent you from network data loss or network downtime.
2. In some area, installing a surge suppression device may also help to protect your switch from being damaged by unregulated surge or current to the Switch or the power adapter.

2.2 Install the Switch

This section describes how to install the Ethernet Switch and make connections to it. Please read the following topics and perform the procedures in the order being presented.

2.2.1 Desktop Installation

To install the Switch on desktop or shelf, please follows these steps:

Step1: Attach the rubber feet to the recessed areas on the bottom of the switch.

Step2: Place the switch on the desktop or the shelf near an AC power source.

Step3: Keep enough ventilation space between the switch and the surrounding objects.

Note: When choosing a location, please keep in mind the environmental restrictions discussed in Chapter 1, Section 4, in Specification.

Step4: Connect the Switch to network devices.

- A. Connect one end of a standard network cable to the 10/100/1000 RJ-45 ports on the front of the Switch
- B. Connect the other end of the cable to the network devices such as printer servers, workstations or routers...etc.

Note: Connection to the Switch requires UTP Category 5 network cabling with RJ-45 tips. For more information, please see the Cabling Specification in Appendix A.

Step5: Supply power to the switch.

- A. Connect one end of the power cable to the switch.
- B. Connect the power plug of the power cable to a standard wall outlet.

When the switch receives power, the Power LED should remain solid Green.

2.2.2 Rack Mounting

To install the switch in a 19-inch standard rack, please follows the instructions described below.

Step1: Place the switch on a hard flat surface, with the front panel positioned towards the front side.

Step2: Attach the rack-mount bracket to each side of the switch with supplied screws attached to the package.

Figure 2-5 shows how to attach brackets to one side of the switch.

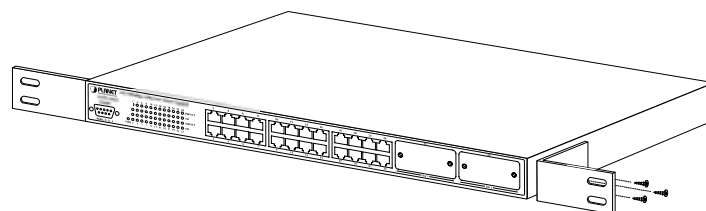

Figure 2-5 Attach brackets to the switch.

Caution:

You must use the screws supplied with the mounting brackets. Damage caused to the parts by using incorrect screws would invalidate the warranty.

Step3: Secure the brackets tightly.

Step4: Follow the same steps to attach the second bracket to the opposite side.

Step5: After the brackets are attached to the Switch, use suitable screws to securely attach the brackets to the rack, as shown in Figure 2-6

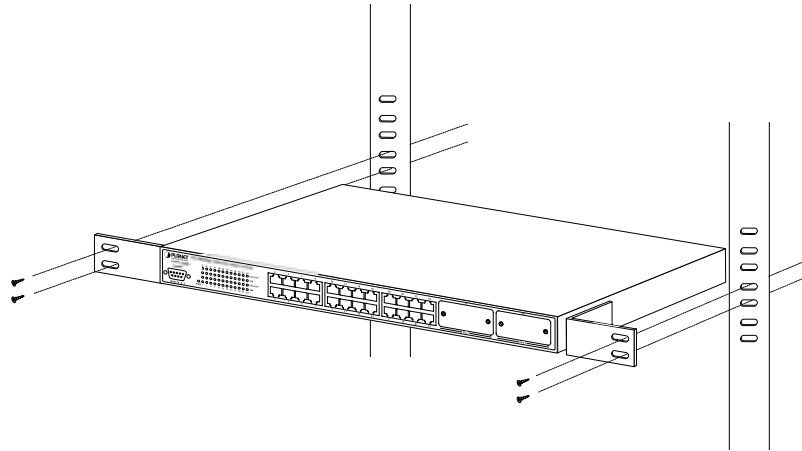

Figure 2-6 Mounting the Switch in a Rack

Step6: Proceeds with the steps 4 and steps 5 of session 2.2.1 Desktop Installation to connect the network cabling and supply power to the switch.

3. CONSOLE MANAGEMENT

3.1 Connecting to the Switch

The console port is a female DB-9 connector that enables a connection to a PC or terminal for monitoring and configuring the Switch. Use the supplied RS-232 cable with a male DB-9 connector to connect a terminal or PC to the Console port. The Console configuration (out of band) allows you to set Switch for remote terminal as if the console terminal were directly connected to it.

3.2 Login in the Console Interface

When the connection between Switch and PC is ready, turn on the PC and run a terminal emulation program or Hyper Terminal and configure its communication parameters to match the following default characteristics of the console port:

Baud Rate: 9600 bps

Data Bits: 8

Parity: none

Stop Bit: 1

Flow control: None

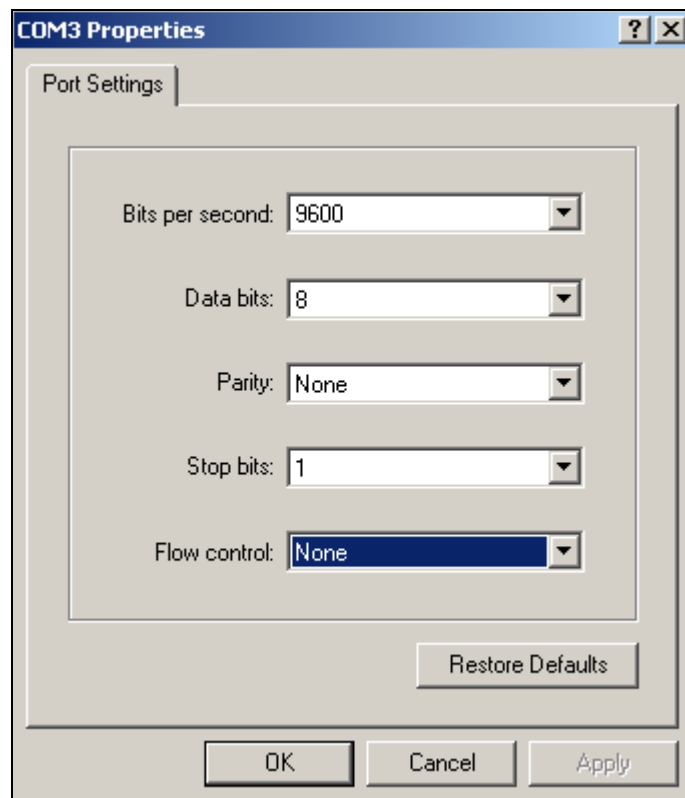

The settings of communication parameters

After finished the parameter settings, click "OK". When the prompt shows "**switch>**", type "?" for help or

type **“enable”** for further configuration. The system needs password for further configuration. After the **“enable”** command, the system asks for password, please enter **“admin”** for the default password. As shows in the following screen:

```

Register Protocol Module: Snmp Module           ... Ok!
Register Protocol Module: Snmp Rmon           ... Ok!
Register Protocol Module: STP                 ... Ok!
Register Hardware Module: STP                 ... Ok!
Register Protocol Module: QVlan               ... Ok!
Register Hardware Module: HwQVlan             ... Ok!
Register Protocol Module: PVlan               ... Ok!
Register Hardware Module: HwPVlan             ... Ok!
Register Protocol Module: Mirror              ... Ok!
Register Hardware Module: Mirror              ... Ok!
Register Protocol Module: mac table           ... Ok!
Register Hardware Module: new mac table driver. ... Ok!
Register Protocol Module: Counter             ... Ok!
Register Hardware Module: HwCounter           ... Ok!
Register Protocol Module: Ruby_QoS            ... Ok!
Register Hardware Module: Ruby_QoS           ... Ok!
Register Protocol Module: IGMP Snooping       ... Ok!
Register Hardware Module: IGMP Snooping Driver ... Ok!
Register Protocol Module: Rate Shaping        ... Ok!
Register Hardware Module: Rate Shaping Driver ... Ok!
Register Protocol Module: Command Line        ... Ok!
Switch>enable
Please input password:
Switch\enable>

```

Console login screen

3.3 Console Management

Entering a question mark "?" at the prompt displays the list of commands available for command mode.

As shows in the following screen:

```

clear manage ip                               Clear manage ip address
clear mirror monitored-port egress            Clear egress monitored port for mirror
clear mirror monitored-port ingress          Clear ingress monitored port for mirror
clear multicast router                       Clear router port
clear port counters                          Clear port statistics counter
clear port rate-shaping                      Clear rate-shaping of all ports
clear port spantree portcost                 Restore spanning tree port cost to
                                             default value
clear port spantree portpri                  Restore spanning tree port priority to
                                             default value
clear port strom-limit                       Clear strom limit of all ports
clear qos map cos-queue-map                  Reset cos-queue map to default
clear qos map dot1p-cos-map                  Reset dot1p_cos map to default
clear qos map mac-cos-map                    Clear qos map mac-cos-map
clear qos map vlan-cos-map                   Clear qos map vlan-cos-map
clear security filter-MAC                    Clear MAC filter entry
clear security static-MAC                    Clear static MAC entry
clear snmp community                         Clear snmp community entry
clear snmp trap                              Clear snmp trap management host
clear spantree root                          Restore spanning tree parameters

clear trunk                                  Clear trunk port from vlans
clear vlan                                    Clear member from vlan
-----MORE-----

```

The question mark “?” command

3.4 Telnet login

The switch also supports telnet for remote management. The switch asks for user name and password for remote login when using telnet, please use “**admin**” for username and “**admin**” for password.

3.5 Commands

There are two levels for console commands. The first level provides commands to show system informations and current configurations. The second level (**privileged mode**) provides commands to set, clear and show the configuration.

3.5.1 First level commands

The follow table lists the first commands and the equivalent usages.

Command	Description
enable	Enable privileged mode
show channel	Show channel information
show console-info	Show console-info
show igmp-snooping	Show igmp snooping information
show ip http server	Show http server information
show ip telnet server	Show telnet server information
show mirror	Show mirror information
show multicast router	Show multicast router port information
show port counter	Show port counter information
show port rate-shaping	Show port ingress and egress rate-shaping
show port spantree	Show spantree information on ports
show port state	Show port information
show port storm-limit	Show port storm limit mode and rate
show qos map cos-queue-map	Show qos map cos-queue-map
show qos map dot1p-cos-map	Show qos map cos-queue-map
show qos map mac-cos-map	Show qos map mac-cos-map
show qos map port-cos-map	Show each port's cos
show qos map vlan-cos-map	Show qos map vlan-cos-map
show qos queue egress-policy	Show qos queue egress-policy
show security MAC-aging	Show MAC aging time
show security filter-MAC	Show MAC filter entry

show security mac-learning	Show port security status
show security static-MAC	Show static mac table information
show snmp	Show snmp information
show snmp rmon	Show snmp rmon state
show spantree	Show spanning tree information
show syntax	Show basic help information
show system	Show system information
show trunk	Show trunk information
show version	Get last software version
show vlan	Show vlan information
show vlan type	Show current vlan type

3.5.2 Privileged Command

To access to the second level, enter the “**enable**” command in the first level. The system then prompts for a password. Please enter “**password**” for the password.

The prompt then changes to “**Switch\enable>**”. Entering a question mark “?” at the prompt displays the list of commands available for command mode.

3.5.2.1 Clear command

Clear command is to clear the parameter. The following table lists the clear commands and the equivalent usages.

Command	Description
clear channel	Clear member from channel
clear mirror monitored-port egress	Clear egress monitored port for mirror
clear mirror monitored-port ingress	Clear ingress monitored port for mirror
clear multicast router	Clear router port
clear port counters	Clear port statistics counter
clear port rate-shaping	Clear rate-shaping of all ports
clear port spantree portcost	Restore spanning tree port cost to default value
clear port spantree portpri	Restore spanning tree port priority to default value
clear port storm-limit	Clear storm limit of all ports
clear qos map cos-queue-map	Reset cos-queue map to default
clear qos map dot1p-cos-map	Reset dot1p_cos map to default
clear qos map mac-cos-map	Clear qos map mac-cos-map
clear qos map vlan-cos-map	Clear qos map vlan-cos-map
clear security filter-MAC	Clear MAC filter entry

clear security static-MAC	Clear static MAC entry
clear snmp community	Clear snmp community entry
clear snmp trap	Clear snmp trap management host
clear spantree root	Restore spanning tree parameters
clear trunk	Clear trunk port from vlans
clear vlan	Clear member from vlan
copy config flash	Copy system configuration parameters to default value
clear port storm-limit	Clear strom limit of all ports
clear qos map cos-queue-map	Reset cos-queue map to default
clear qos map dot1p-cos-map	Reset dot1p_cos map to default
clear qos map mac-cos-map	Clear qos map mac-cos-map
clear qos map vlan-cos-map	Clear qos map vlan-cos-map
clear security filter-MAC	Clear MAC filter entry
clear security static-MAC	Clear static MAC entry
clear snmp community	Clear snmp community entry
clear snmp trap	Clear snmp trap management host
clear spantree root	Restore spanning tree parameters
clear trunk	Clear trunk port from vlans
clear vlan	Clear member from vlan

3.5.2.2 Copy command

Once the configuration is changed, it remains the original after a reboot unless the configuration is saved.

Copy command is to save the current configuration to the flash, this saves the configuration to next reboot.

Command	Description
copy config flash	Copy system configuration parameters to flash

3.5.2.3 Disable command

Disable command is to exit the privileged mode and back to the first level of command line interface.

Command	Description
Disable	Disable privileged mode

3.5.2.4 Reboot command

Reboot command is to reboot the switch, please beware to check if the configuration is saved..

Command	Description
Reboot	Reboot system

3.5.2.5 Set command

Set command is to change the parameter of the switch functions. The follow table lists the set commands and the equivalent usages.

Command	Description
set channel	Set ports to be channel
set default	Set system load default parameters
set enable password	Set the password for the privileged level of the CLI
set igmp-snooping disable	Disable igmp snooping
set igmp-snooping enable	Enable igmp snooping
set ip http server disable	Disable http server
set ip http server enable	Enable http server
set ip telnet server disable	Disable telnet server
set ip telnet server enable	Enable telnet server
set mirror	Enable/Disable mirror function
set mirror capture-port	Set a port to capture traffic
set mirror monitored-port egress	Capture egress traffic
set mirror monitored-port ingress	Capture ingress traffic
set multicast router	Set multicst router port
set password	Set the password for telnet
set port disable	Disable a port
set port duplex	Set port transmission type
set port enable	Enable a port
set port flow-control	Set port traffic flowcontrol
set port rate-shaping egress	Set port egress rate-shaping rate
set port rate-shaping ingress	Set port ingress rate-shaping rate
set port rate-shaping egress	Set port egress rate-shaping rate
set port rate-shaping ingress	Set port ingress rate-shaping rate
set port spantree <port_num> portco	Set spanning tree port cost
set port spantree <port_num> portfa	Set spanning tree PortFast feature
set port spantree <port_num> portpr	Set spanning tree port priority
set port speed	Set port transmission speed
set port storm-limit mode	Set port storm limit mode
set port storm-limit rate	Set port storm limit rate
set qos map cos-queue-map	Set the queue number of each cos
set qos map dot1p-cos-map	Set the cos value of each dot1p priority
set qos map mac-cos-map	Set MAC based qos
set qos map port-cos-map	Set port's cos

set qos map vlan-cos-map	Set vlan based qos
set qos queue egress-policy	Set the egress policy
set security MAC-aging	Set MAC aging time
set security filter-MAC	Create MAC filter entry
set security mac-learning	Set port learning MAC (enable disable)
set security static-MAC	Create static MAC entry
set snmp	Enable/Disable snmp agent
set snmp community	Set snmp community string
set spantree fwddelay	Set the forward delay for the spanning tree
set spantree hello	Set the hello interval for the spanning tree
set spantree maxage	Set the max age interval for the spanning
set spantree priority	Set the bridge priority for the spanning tree
set system contact	Set system contact
set system default-gateway	Set default gateway
set system ip	Set system ip mask
set system location	Set system location
set system mac	Set system mac address
set system management-vlan	Specify a vlan for system management
set system name	Set system name
set trunk	Set vlan trunk port
set vlan <vid> name	Set vlan name
set vlan <vlan id> <portlist>	Set vlan members
set vlan type port-based	Set system be port-based vlan
set vlan type dot1q-based	Set system be dot1q-based vlan
set snmp rmon	Enable/Disable rmon state
set snmp trap	Set snmp trap receive host
set spantree disable	Disable spanning tree

3.5.2.6 Show command

Show command is to display the current parameter of the switch functions. The follow table lists the show commands and the equivalent usages.

Command	Description
show channel	Show channel information
show console-info	Show console-info
show igmp-snooping	Show igmp snooping information
show ip http server	Show http server information
show ip telnet server	Show telnet server information

show mirror	Show mirror information
show multicast router	Show multicast router port information
show port counter	Show port counter information
show port rate-shaping	Show port ingress and egress rate-shaping
show port spantree	Show spantree information on ports
show port state	Show port information
show port storm-limit	Show port storm limit mode and rate
show qos map cos-queue-map	Show qos map cos-queue-map
show qos map dot1p-cos-map	Show qos map cos-queue-map
show qos map mac-cos-map	Show qos map mac-cos-map
show qos map port-cos-map	Show each port's cos
show qos map vlan-cos-map	Show qos map vlan-cos-map
show qos queue egress-policy	Show qos queue egress-policy
show security MAC-aging	Show MAC aging time
show security filter-MAC	Show MAC filter entry
show security mac-learning	Show port security status
show security static-MAC	Show static mac table information
show snmp	Show snmp information
show snmp rmon	Show snmp rmon state
show spantree	Show spanning tree information
show syntax	Show basic help information
show system	Show system information
show trunk	Show trunk information
show version	Get last software version
show vlan	Show vlan information
show vlan type	Show current vlan type

4. WEB-BASED MANAGEMENT

This section introduces the configuration and functions of the Web-Based management.

4.1 About Web-based Management

The switch offers management features that allow users to manage the switch from anywhere on the network through a standard browser such as Microsoft Internet Explorer.

The Web-Based Management supports Internet Explorer 5.0. It is based on Java Applets with an aim to reduce network bandwidth consumption, enhance access speed and present an easy viewing screen.

Note: By default, IE5.0 or later version does not allow Java Applets to open sockets. The user has to explicitly modify the browser setting to enable Java Applets to use network ports.

4.2 Preparing for Web Management

Before use web management, you can use console to login the Switch checking the default IP of the Switch. Please refer to Console Management Chapter for console login. If you need change IP address in first time, you can use console mode to modify it. The default value is as below:

IP Address: **192.168.0.100**

Subnet Mask: **255.255.255.0**

Default Gateway: **192.168.0.254**

User Name: **admin**

Password: **admin**

4.3 System Login

1. Launch the Internet Explorer.
2. Enter the IP address of the switch.
3. When the login screen appears, use **admin/admin** as the default username/password respectively to login.
4. The main web page of the Web-based management appears. As shows in the following screen.

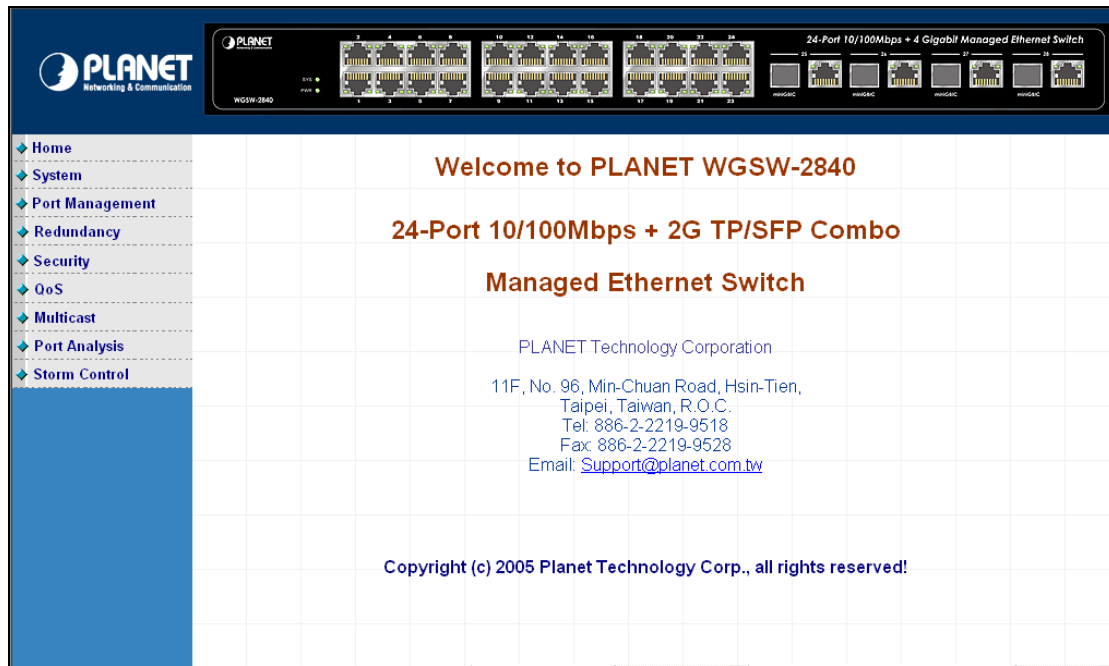

WGSW-2840 Web Management Interface

4.4 System

4.4.1 IP Configuration

The switch can be managed by the Web/Telnet/SNMP interfaces. Administrators can access the management interface via the IP address of the switch. The default IP address of the switch is 192.168.0.100. You can change the IP address to be in the same IP segment as your LAN network for convenience.

To change the IP address, click on the **System/IP Address** menu button. The IP address configuration screen then shows in the main page on the web. Enter the new IP address, Submask and Gateway then click on the **OK** button to change.

IP Address Configuration

**NOTE:**

1. The Switch's factory-default IP address is 192.168.0.100 with Submask 255.255.255.0 and a default gateway of 192.168.0.254
2. The changed IP address take effect immediately after click on the OK button, you need to use the new IP address to access the Web interface.
3. The changed IP address remains the original after reboot the switch unless the configuration is saved.
To save the changed IP address, please move to **System/Saving Parameters** menu.

4.4.2 SNMP

4.4.2.1 Theory

The Simple Network Management Protocol (SNMP) is an application layer protocol that facilitates the exchange of management information between network devices. It is part of the Transmission Control Protocol/Internet Protocol (TCP/IP) protocol suite. SNMP enables network administrators to manage network performance, find and solve network problems, and plan for network growth.

An SNMP-managed network consists of three key components: Network management stations (NMSs), SNMP agents, Management information base (MIB) and network-management protocol :

- **Network management stations (NMSs)** : Sometimes called consoles, these devices execute management applications that monitor and control network elements. Physically, NMSs are usually engineering workstation-caliber computers with fast CPUs, megapixel color displays, substantial memory, and abundant disk space. At least one NMS must be present in each managed environment.
- **Agents** : Agents are software modules that reside in network elements. They collect and store management information such as the number of error packets received by a network element.
- **Management information base (MIB)** : A MIB is a collection of managed objects residing in a virtual information store. Collections of related managed objects are defined in specific MIB modules.
- **network-management protocol** : A management protocol is used to convey management information between agents and NMSs. SNMP is the Internet community's de facto standard management protocol.

SNMP Operations

SNMP itself is a simple request/response protocol. NMSs can send multiple requests without receiving a response.

- **Get** -- Allows the NMS to retrieve an object instance from the agent.
- **Set** -- Allows the NMS to set values for object instances within an agent.
- **Trap** -- Used by the agent to asynchronously inform the NMS of some event. The SNMPv2 trap

message is designed to replace the SNMPv1 trap message.

SNMP community

An SNMP community is the group that devices and management stations running SNMP belong to. It helps define where information is sent. The community name is used to identify the group. A SNMP device or agent may belong to more than one SNMP community. It will not respond to requests from management stations that do not belong to one of its communities. SNMP default communities are:

- **Write** = private
- **Read** = public

4.2.2.2 SNMP Configuration

To configure SNMP management, click on **System/SNMP** menu button, and the web main page changes to the SNMP Management function, as shows in the following:

The screenshot displays the 'SNMP Management' web interface. It is divided into four main sections:

- SNMP Agent Status Configuration:** Features a dropdown menu for 'SNMP Agent Status' set to 'Enable' and an 'OK' button.
- System Options:** Includes text input fields for 'System Name' (containing 'Switch'), 'System Location', and 'Contact', with an 'OK' button below.
- Community Configuration:** Split into two columns. The left column has an 'Add Community' field, radio buttons for 'Read Only' (selected) and 'Read/Write', and an 'Add' button. The right column has a 'Current Communities' list showing 'public-----Read Only' and a 'Delete' button.
- Management Station Configuration:** Split into two columns. The left column has an 'Add Management Station' section with an 'IP Address' field. The right column has a 'Current Management Stations' list.

The followings are the description of the sub-table.

1. SNMP Agent Status Configuration

This block enables to turn on SNMP Agent.

Enabled / Disabled: To turn on or turn off the SNMP function on the Switch.

This is a close-up of the 'SNMP Agent Status Configuration' section. It shows a label 'SNMP Agent Status:' followed by a dropdown menu currently displaying 'Enable'. Below the dropdown is an 'OK' button.

2. System Options

This table is to define the system name, system location and the contact person of the switch. These informations show in the SNMP software of the management workstation which helps to identify the switch that is looking into.

There are three fields in the “**system options**” configuration block:

- **System Name:** The system name of the switch which would show in the SNMP software.
- **System Location:** The system location of the switch which would show in the SNMP software.
- **Contact:** The contact person of the switch which would show in the SNMP software.

Fill the fields and click on the “**OK**” button to save.

System Options	
System Name:	WGSW-2840
System Location:	TAIPEI
Contact:	SYSTEM MANAGER
OK	

3. Community Configuration

Use this table to configure the SNMP community strings and define the policy of the relative string. The community string acts like a password to permit access to the agent on the Switch. One or more of the following characteristics can be associated with the community string:

- **Add Community:** enter private or public
- Chooses community strings for the Switch management access: read only or read/write
- **Read only:** Enables requests accompanied by this string to display MIB-object information.
- **Read/Write:** Enables requests accompanied by this string to display MIB-object information and to set MIB objects.

Complete the above steps and click on the “**Add**” button.

Community Configuration	
Add Community	Current Communities
private	
<input checked="" type="radio"/> Read Only <input type="radio"/> Read/Write	
Add	Delete

The added string then shows in the Current Communities field.

- **Current Communities:** show the list in input field

Community Configuration	
Add Community	Current Communities
<input type="text"/>	private-----Read Only
<input checked="" type="radio"/> Read Only <input type="radio"/> Read/Write	
<input type="button" value="Add"/>	<input type="button" value="Delete"/>

4. Management Station Configuration

A trap manager is a management station (SNMP application) that receives traps (the system alerts generated by the switch). If no trap manager is defined, no traps are issued. Create a trap manager by entering the IP address of the station and a community string.

- Enter Network management stations IP address: 192.168.0.53 (for example)
- **Trap Community:** must be the same string as “Add community”

Then click on “Add” button.

Management Station Configuration	
Add Management Station	Current Management Stations
IP Address <input type="text" value="192.168.0.53"/>	<input type="text"/>
Trap Community <input type="text" value="private"/>	
<input type="button" value="Add"/>	<input type="button" value="Delete"/>

The “Current Management Stations” field shows the trap list.

Management Station Configuration	
Add Management Station	Current Management Stations
IP Address <input type="text"/>	192.168.0.53-----private
Trap Community <input type="text"/>	
<input type="button" value="Add"/>	<input type="button" value="Delete"/>

4.4.3 Password

The **Password** management menu is to set or change the password of the Web Management Interface. Click on **System/Password** menu button, and the **Modify Password** table shows in the main web page. Enter “old password “, “new password”, “confirm password” Click “OK” to change the password.



Modify Password	
Old Password	<input type="text"/>
New Password	<input type="text"/>
Confirm Password	<input type="text"/>
<input type="button" value="OK"/>	

4.4.4 CONSOLE

This function shows the connection parameters for the Console Management Interface. Click on the **System/CONSOLE** menu button, and the following table shows in the main page of the web.

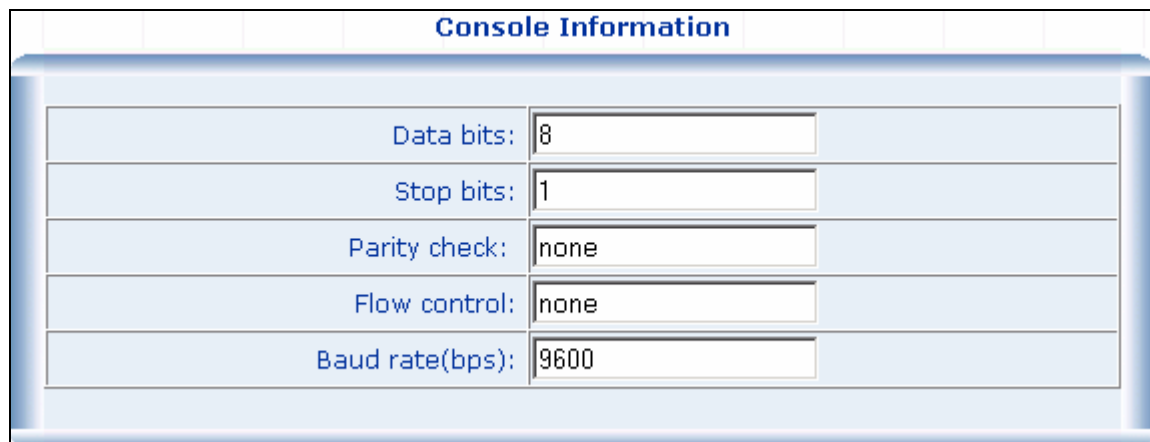

Console Information	
Data bits:	<input type="text" value="8"/>
Stop bits:	<input type="text" value="1"/>
Parity check:	<input type="text" value="none"/>
Flow control:	<input type="text" value="none"/>
Baud rate(bps):	<input type="text" value="9600"/>

4.4.5 System Upgrade

This function allows performing firmware update from the web interface.

Click on the **System/System Upgrade** menu button, and the following table shows in the main page of the web.

Click on the “**Browse**” button of the main page, the system would pop up the file selection menu to choose firmware. Select on the firmware, and the **Update Status** would show the file upload status.

System Upgrade	
The File's Name	<input type="text"/> <input type="button" value="Browse..."/>
Update Status:	<input type="text"/>
<input type="button" value="Update"/>	



CAUTION: Do not power off the switch until the update progress is complete.

4.4.6 Saving Parameters

It takes effect immediately when you change the parameters of the management function when the switch is running. But the parameters would not be saved after reboot the switch. To keep the changed parameters, Click on the **System/Saving Parameters** menu button, and click on the “**Save**” button on the web main page as show in the following.

Parameters Saving	
	This operation will save all your parameters on the switch. After reboot the switch, all the parameters are still valid.
<input type="button" value="Save"/>	

4.4.7 Parameters Backup & Recovery

This function is to backup the running configuration to the workstation and to restore the configuration you had saved in the workstation.

Click on the **System/Backup & Recovering** menu button, and the following table shows in the web main page.

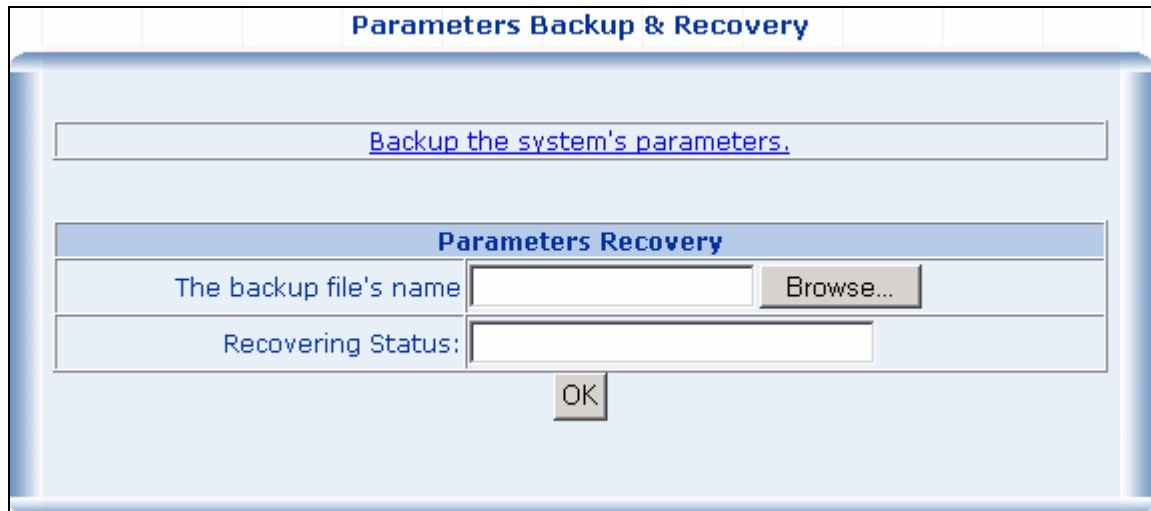

To backup the running configuration, click on the “**Backup the system’s parameters**” link, and a pop up window shows to save the configuration of the switch to your workstation.

To recover a saved configuration, click on the “**Browse**” button in the Parameters Recovery table. A pop up window would direct you to upload the configuration file.

4.4.8 Load Default

This function is to reset the configuration of switch to the factory default. Click on the **System/Load Default** menu button, and the following table shows in the web main page.

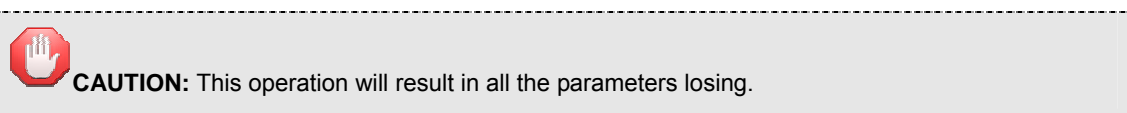
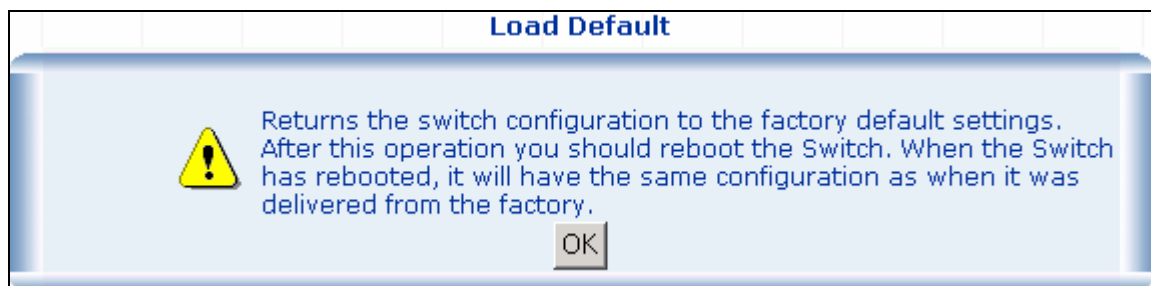

4.4.9 Reboot

This function is to reboot the system.

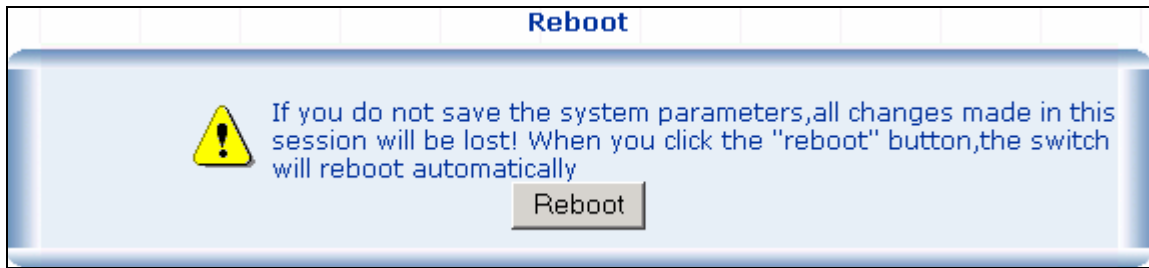

4.5 Port Management

4.5.1 Port Configuration

This function is to configure and to view the configured port management status, port negotiation mode and the port flow control function.

- **Management Status:** Display port status: Enable or Disable. Disable is to turn off the port.
- **Link Status:** "Up" to indicate the port is linked while "Down" to indicate the port is not connectd.
- **Speed:** Shows the negotiation mode and the running speed on the port.
- **Duplex:** Displays full-duplex or half-duplex mode.
- **Flow Control:** Display Flow status of port: Enable or Disable, Disable indicates Flow control is off.
- **Auto:** Display which mode the port is auto-negotiated
- **Config:** (configured) Displays the state defined by the user.
- **Atual:** Displays the negotiation result.

Port Configuration									
Port Configuration									
Port List (e.g. 1-3,7)	Management Status	Speed/Duplex	Flow Control						
<input type="text" value=""/>	Enable ▾	Auto ▾	Disable ▾						
<input type="button" value="OK"/>									
Port status									
Port	Management Status	Link Status	Speed		Duplex		Flow Control		
			Config	Actual	Config	Actual	Config	Actual	
Port 1	Enable	Down	Auto	NA	Auto	NA	Disable	NA	
Port 2	Enable	Down	Auto	NA	Auto	NA	Disable	NA	
Port 3	Enable	Down	Auto	NA	Auto	NA	Disable	NA	
Port 4	Enable	Down	Auto	NA	Auto	NA	Disable	NA	
Port 5	Enable	Down	Auto	NA	Auto	NA	Disable	NA	
Port 6	Enable	Up	Auto	100M	Auto	Full	Disable	Disable	
Port 7	Enable	Down	Auto	NA	Auto	NA	Disable	NA	
Port 8	Enable	Down	Auto	NA	Auto	NA	Disable	NA	

4.5.2 Port Statistics

The Port Statistics page provides a view of the current status of every port on the Switch.

Pressing the "Reset" button will reset all port counters to zero.

Port Statistics								
Port	Management Status	Link Status	Rx Bytes	Rx Pkts	Tx Bytes	Tx Pkts	Collision Pkts	Discard Pkts
Port1	Enable	Down	0	0	0	0	0	0
Port2	Enable	Down	0	0	0	0	0	0
Port3	Enable	Down	0	0	0	0	0	0
Port4	Enable	Down	0	0	0	0	0	0
Port5	Enable	Down	0	0	0	0	0	0
Port6	Enable	Up	1355316	11613	6544539	22163	0	0
Port7	Enable	Down	0	0	0	0	0	0
Port8	Enable	Down	0	0	0	0	0	0

4.5.3 Port Band Restrict

The function provides the In-Band and Out-Band connection speed restriction on the ports. The Band of the connection speed ranges from 64Kbps to 80000Kbps.

Ingress Port List/Egress Port List field can be filled in distinct number or a port range. For example, you can fill with "1, 3" for port 1 and port 3 and "3-5" for port 3 to port 5.

Band(64~80000Kbps) field can be filled with any number between 64 and 80000.

Port Band Restrict			
In-Band Restrict			
Ingress Port List		Band(64~80000Kbps)	
<input type="text"/>		<input type="text"/> Kbps	
Out-Band Restrict			
Egress Port List		Band(64~80000Kbps)	
<input type="text"/>		<input type="text"/> Kbps	
OK			
Port Status			
Port	In-Band Restrict(Kbps)	Out-Band Restrict(Kbps)	Delete
1	64	0	Delete
2	64	500	Delete
3	64	500	Delete
4	64	0	Delete
5	0	0	Delete
6	0	0	Delete
7	0	0	Delete
8	0	0	Delete

4.6 Redundancy

4.6.1 Spanning Tree

1. Spanning Tree Protocol

The IEEE 802.1D Spanning Tree Protocol and IEEE 802.1W Rapid Spanning Tree Protocol allow for the blocking of links between switches that form loops within the network. When multiple links between switches are detected, a primary link is established. Duplicated links are blocked from use and become standby links. The protocol allows for the duplicate links to be used in the event of a failure of the primary link. Once the Spanning Tree Protocol is configured and enabled, primary links are established and duplicated links are blocked automatically. The reactivation of the blocked links (at the time of a primary link failure) is also accomplished automatically without operator intervention.

This automatic network reconfiguration provides maximum uptime to network users. However, the concepts of the Spanning Tree Algorithm and protocol are a complicated and complex subject and must be fully researched and understood. It is possible to cause serious degradation of the performance of the network if the Spanning Tree is incorrectly configured. Please read the following before making any changes from the default values.

The Switch STP performs the following functions:

- Creates a single spanning tree from any combination of switching or bridging elements.
- Creates multiple spanning trees – from any combination of ports contained within a single switch, in user specified groups.
- Automatically reconfigures the spanning tree to compensate for the failure, addition, or removal of any element in the tree.
- Reconfigures the spanning tree without operator intervention.

Bridge Protocol Data Units

For STP to arrive at a stable network topology, the following information is used:

- The unique switch identifier
- The path cost to the root associated with each switch port
- The port identifier

STP communicates between switches on the network using Bridge Protocol Data Units (BPDUs). Each BPDU contains the following information:

- The unique identifier of the switch that the transmitting switch currently believes is the root switch
- The path cost to the root from the transmitting port
- The port identifier of the transmitting port

The switch sends BPDUs to communicate and construct the spanning-tree topology. All switches connected to the LAN on which the packet is transmitted will receive the BPDU. BPDUs are not directly forwarded by the switch, but the receiving switch uses the information in the frame to calculate a BPDU, and, if the topology changes, initiates a BPDU transmission.

The communication between switches via BPDUs results in the following:

- One switch is elected as the root switch
- The shortest distance to the root switch is calculated for each switch
- A designated switch is selected. This is the switch closest to the root switch through which packets will be forwarded to the root.
- A port for each switch is selected. This is the port providing the best path from the switch to the root switch.
- Ports included in the STP are selected.

Creating a Stable STP Topology

It is to make the root port a fastest link. If all switches have STP enabled with default settings, the switch with the lowest MAC address in the network will become the root switch. By increasing the priority (lowering the priority number) of the best switch, STP can be forced to select the best switch as the root switch.

When STP is enabled using the default parameters, the path between source and destination stations in a switched network might not be ideal. For instance, connecting higher-speed links to a port that has a higher number than the current root port can cause a root-port change.

STP Port States

The BPDUs take some time to pass through a network. This propagation delay can result in topology changes where a port that transitioned directly from a Blocking state to a Forwarding state could create temporary data loops. Ports must wait for new network topology information to propagate throughout the network before starting to forward packets. They must also wait for the packet lifetime to expire for BPDU packets that were forwarded based on the old topology. The forward delay timer is used to allow the network topology to stabilize after a topology change. In addition, STP specifies a series of states a port must transition through to further ensure that a stable network topology is created after a topology change.

Each port on a switch using STP exists in one of the following five states:

- **Blocking** – the port is blocked from forwarding or receiving packets
- **Listening** – the port is waiting to receive BPDU packets that may tell the port to go back to the blocking state
- **Learning** – the port is adding addresses to its forwarding database, but not yet forwarding packets
- **Forwarding** – the port is forwarding packets
- **Disabled** – the port only responds to network management messages and must return to the blocking state first

A port transitions from one state to another as follows:

- From initialization (switch boot) to blocking
- From blocking to listening or to disabled

- From listening to learning or to disabled
- From learning to forwarding or to disabled
- From forwarding to disabled
- From disabled to blocking

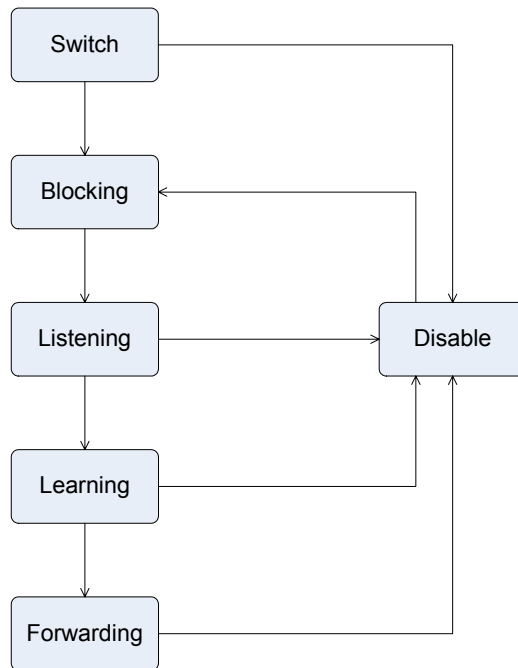

STP Port State Transitions

You can modify each port state by using management software. When you enable STP, every port on every switch in the network goes through the blocking state and then transitions through the states of listening and learning at power up. If properly configured, each port stabilizes to the forwarding or blocking state. No packets (except BPDUs) are forwarded from, or received by, STP enabled ports until the forwarding state is enabled for that port.

2. STP Parameters

STP Operation Levels

The Switch allows for two levels of operation: the switch level and the port level. The switch level forms a spanning tree consisting of links between one or more switches. The port level constructs a spanning tree consisting of groups of one or more ports. The STP operates in much the same way for both levels.



NOTICE: On the switch level, STP calculates the Bridge Identifier for each switch and then sets the Root Bridge and the Designated Bridges.

On the port level, STP sets the Root Port and the Designated Ports.

The following are the user-configurable STP parameters for the switch level:

Parameter	Description	Default Value
Bridge Identifier(Not user	A combination of the User-set priority and	32768 + MAC

configurable except by setting priority below)	the switch's MAC address. The Bridge Identifier consists of two parts: a 16-bit priority and a 48-bit Ethernet MAC address 32768 + MAC	
Priority	A relative priority for each switch – lower numbers give a higher priority and a greater chance of a given switch being elected as the root bridge	32768
Hello Time	The length of time between broadcasts of the hello message by the switch	2 seconds
Maximum Age Timer	Measures the age of a received BPDU for a port and ensures that the BPDU is discarded when its age exceeds the value of the maximum age timer.	20 seconds
Forward Delay Timer	The amount time spent by a port in the learning and listening states waiting for a BPDU that may return the port to the blocking state.	15 seconds

The following are the user-configurable STP parameters for the port or port group level:

Variable	Description	Default Value
Port Priority	A relative priority for each port –lower numbers give a higher priority and a greater chance of a given port being elected as the root port	32768
Port Cost	A value used by STP to evaluate paths – STP calculates path costs and selects the path with the minimum cost as the active path	19-100Mbps Fast Ethernet ports 4-1000Mbps Gigabit Ethernet ports

Default Spanning-Tree Configuration

Feature	Default Value
Enable state	STP enabled for all ports
Port priority	128
Port cost	19
Bridge Priority	32,768

User-Changeable STA Parameters

The Switch's factory default setting should cover the majority of installations. However, it is advisable to keep the default settings as set at the factory; unless, it is absolutely necessary. The user changeable

parameters in the Switch are as follows:

Priority – A Priority for the switch can be set from 0 to 65535. 0 is equal to the highest Priority.

Hello Time – The Hello Time can be from 1 to 10 seconds. This is the interval between two transmissions of BPDU packets sent by the Root Bridge to tell all other Switches that it is indeed the Root Bridge. If you set a Hello Time for your Switch, and it is not the Root Bridge, the set Hello Time will be used if and when your Switch becomes the Root Bridge.

 **NOTICE:** The Hello Time cannot be longer than the Max. Age. Otherwise, a configuration error will occur.

Max. Age – The Max Age can be from 6 to 40 seconds. At the end of the Max Age, if a BPDU has still not been received from the Root Bridge, your Switch will start sending its own BPDU to all other Switches for permission to become the Root Bridge. If it turns out that your Switch has the lowest Bridge Identifier, it will become the Root Bridge.

Forward Delay Timer – The Forward Delay can be from 4 to 30 seconds. This is the time any port on the Switch spends in the listening state while moving from the blocking state to the forwarding state.

 **NOTICE:** Observe the following formulas when setting the above parameters:

Max. Age $\geq 2 \times$ (Forward Delay - 1 second)
Max. Age $\geq 2 \times$ (Hello Time + 1 second)

Port Priority – A Port Priority can be from 0 to 255. The lower the number, the greater the probability the port will be chosen as the Root Port.

Port Cost – A Port Cost can be set from 0 to 65535. The lower the number, the greater the probability the port will be chosen to forward packets.

3. Illustration of STP

A simple illustration of three switches connected in a loop is depicted in Figure 5-7. In this example, you can anticipate some major network problems if the STP assistance is not applied. If switch A broadcasts a packet to switch B, switch B will broadcast it to switch C, and switch C will broadcast it to back to switch A ... and so on. The broadcast packet will be passed indefinitely in a loop, potentially causing a network failure. In this example, STP breaks the loop by blocking the connection between switch B and C. The decision to block a particular connection is based on the STP calculation of the most current Bridge and Port settings. Now, if switch A broadcasts a packet to switch C, then switch C will drop the packet at port 2 and the broadcast will end there. Setting-up STP using values other than the defaults, can be complex. Therefore, you are advised to keep the default factory settings and STP will automatically assign root bridges/ports and block loop connections. Influencing STP to choose a particular switch as the root bridge using the Priority setting, or influencing STP to choose a particular port to block using the Port Priority and Port Cost settings is, however, relatively straight forward.

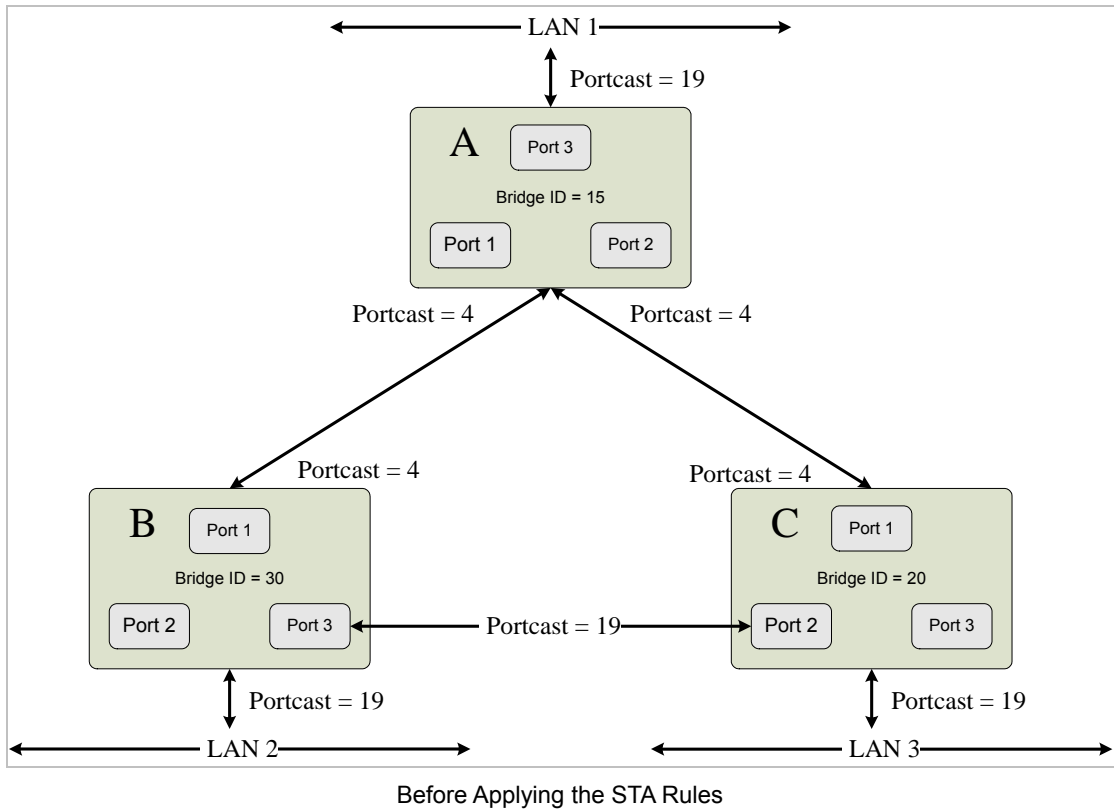

In this example, only the default STP values are used.

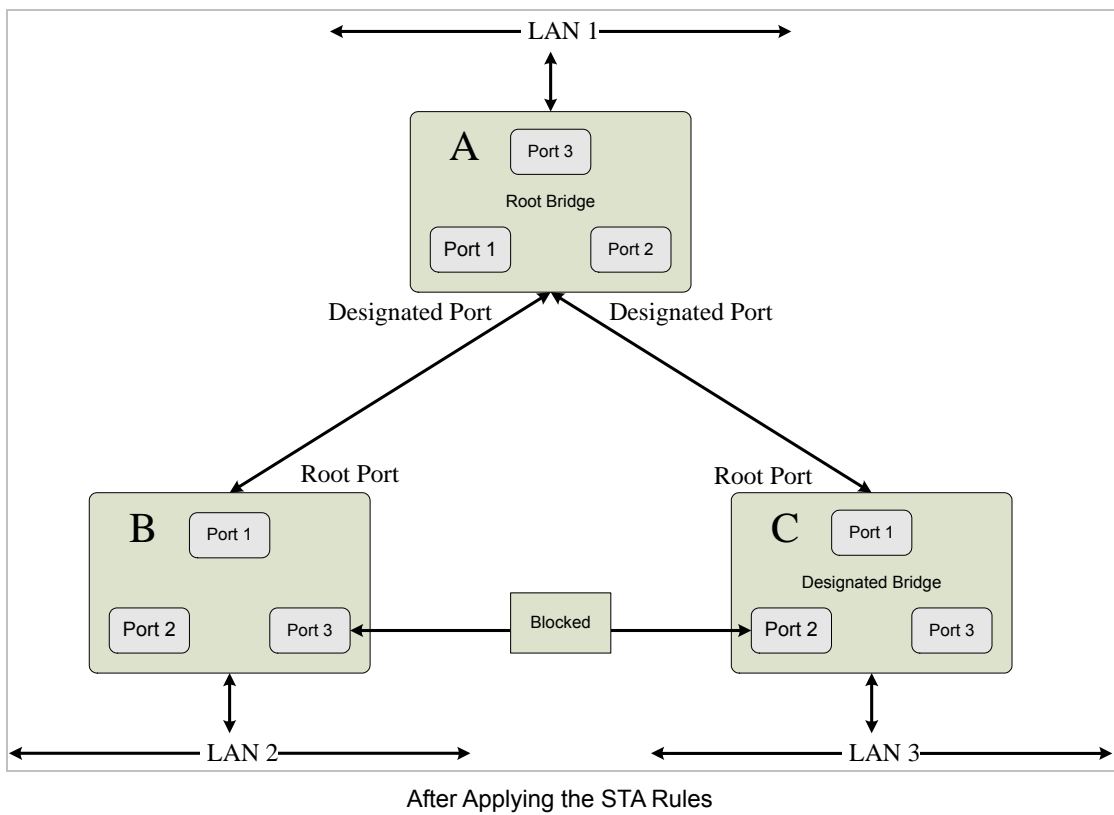

The switch with the lowest Bridge ID (switch C) was elected the root bridge, and the ports were selected to give a high port cost between switches B and C. The two (optional) Gigabit ports (default port cost = 4) on switch A are connected to one (optional) Gigabit port on both switch B and C. The redundant link

between switch B and C is deliberately chosen as a 100 Mbps Fast Ethernet link (default port cost = 19). Gigabit ports could be used, but the port cost should be increased from the default to ensure that the link between switch B and switch C is the blocked link.

4.6.2 Spanning Tree Configuration

The Spanning Tree Protocol (STP) operates on two levels: On the switch level, the settings are globally implemented. On the port level, the settings are implemented on a per user-defined Group of ports.

1. Spanning Tree Configuration

The “**Rapid Spanning Tree Bridge Configure**” table allows configuring the spanning tree parameters.

Rapid Spanning Tree Status: The spanning tree function of the switch is default disabled. This field enables to turn on the spanning tree on the switch.

Force Protocol Version: 0 for IEEE 802.1D Spanning Tree, 2 for IEEE 802.1W Rapid Spanning Tree

Max Age: (6 - 40 sec) the default setting is 20

Hello Time: (1 - 10sec) the default setting is 2

Forward Delay: (4 -30 sec) the default setting is 15

Bridge Priority: (0 - 61440) the default setting is 32768

Rapid Spanning Tree Bridge Configuration	
Rapid Spanning Tree Status:	Enable ▾
Force Protocol Version :	2 ▾
Max Age(6-40s):	20
Hello Time(1-10s):	2
Forward Delay(4-30s):	15
Bridge Priority(0-61440):	32768
OK	

2. Bridge Information

The informations of the STP Root show in the Bridge Information table.

Bridge Information	
Root Bridge Priority:	32768
Root Bridge M&C:	00-00-01-01-02-02
Root Path Cost:	0
Root Port:	N/A
Root Bridge MAX age:	20
Root Bridge Hello Time:	2
Root Bridge Forward Delay:	15

3. STP Port Configuration

The following fields can be set for STP port configuration:

Port Priority: Defines if this port is more or less likely to become the root port. The range is from 0 to 255,

the default setting is 128. The lower number has the highest priority.

Path Cost: Specifies the path cost of the port. The switch uses this parameter to help determine which port will become a forwarding port. Lower numbers will be used as forwarding ports first. The range is from 0 to 65535. The default values based on IEEE802.1D are: 10Mb/s = 50-600, 100Mb/s = 10-60, 1000Mb/s = 3-10

RSTP Port Configuration				
Port List(e.g. 1-3,7)	Edge Port	P2P Status	Path Cost(0-200000000,0 means Auto)	Port Priority(0-240)
<input type="text"/>	True <input type="button" value="v"/>	Auto <input type="button" value="v"/>	<input type="text"/>	<input type="text"/>
<input type="button" value="OK"/>				

4.6.3 Link Aggregation

The Link Aggregation Control Protocol (LACP) provides a standardized means for exchanging information between Partner Systems that require high speed redundant links. Link aggregation lets you group up to eight consecutive ports into a single dedicated connection. This feature can expand bandwidth to a device on the network. LACP operation requires full-duplex mode, more detail information refer to the IEEE 802.3ad standard.

Port link aggregations can be used to increase the bandwidth of a network connection or to ensure fault recovery. Link aggregation lets you group up to 4 consecutive ports into a single dedicated connection between any two the Switch or other Layer 2 switches. However, before making any physical connections between devices, use the Link aggregation Configuration menu to specify the link aggregation on the devices at both ends. When using a port link aggregation, note that:

- The ports used in a link aggregation must all be of the same media type (RJ-45, 100 Mbps fiber).
- The ports that can be assigned to the same link aggregation have certain other restrictions (see below).
- Ports can only be assigned to one link aggregation.
- The ports at both ends of a connection must be configured as link aggregation ports.
- None of the ports in a link aggregation can be configured as a mirror source port or a mirror target port.
- All of the ports in a link aggregation have to be treated as a whole when moved from/to, added or deleted from a VLAN.
- The Spanning Tree Protocol will treat all the ports in a link aggregation as a whole.
- Enable the link aggregation prior to connecting any cable between the switches to avoid creating a data loop.
- Disconnect all link aggregation port cables or disable the link aggregation ports before removing a port link aggregation to avoid creating a data loop.

It allows a maximum of eight ports to be aggregated at the same time. The Switch support Gigabit Ethernet ports (up to 12 groups). If the group is defined as a LACP static link aggregating group, then any extra ports selected are placed in a standby mode for redundancy if one of the other ports fails. If the group is defined as a local static link aggregating group, then the number of ports must be the same as the group member ports.

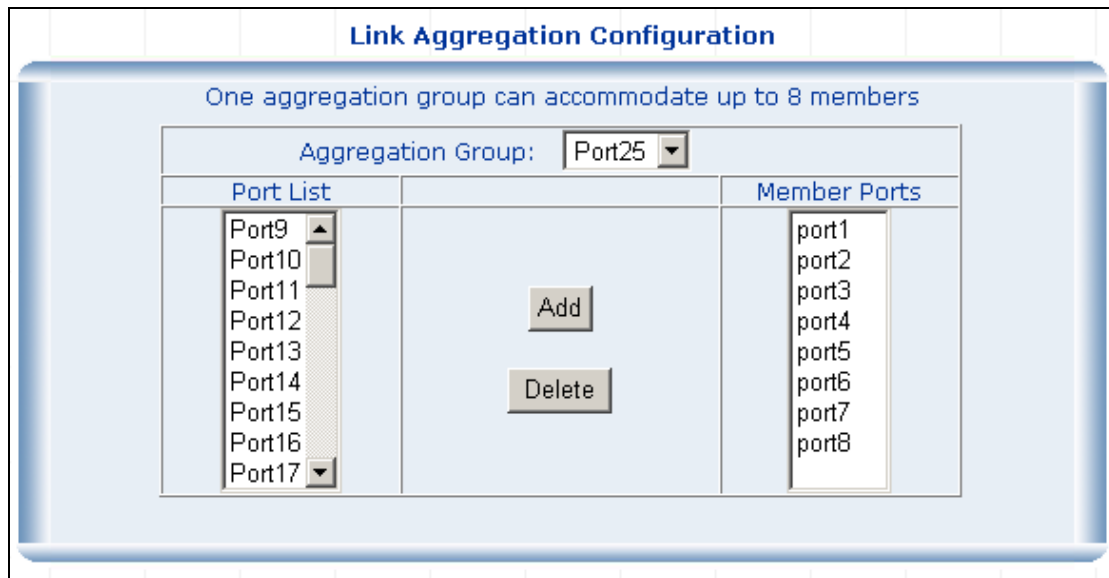

4.7 Security

4.7.1 VLAN

4.7.1.1 Theory

Understanding IEEE 802.1p Priority

Priority tagging is a function defined by the IEEE 802.1p standard designed to provide a means of managing traffic on a network where many different types of data may be transmitted simultaneously. It is intended to alleviate problems associated with the delivery of time critical data over congested networks. The quality of applications that are dependent on such time critical data, such as video conferencing, can be severely and adversely affected by even very small delays in transmission.

Network devices that are in compliance with the IEEE 802.1p standard have the ability to recognize the priority level of data packets. These devices can also assign a priority label or tag to packets. Compliant devices can also strip priority tags from packets. This priority tag determines the packet's degree of expeditiousness and determines the queue to which it will be assigned.

Priority tags are given values from 0 to 7 with 0 being assigned to the lowest priority data and 7 assigned to the highest. The highest priority tag 7 is generally only used for data associated with video or audio

applications, which are sensitive to even slight delays, or for data from specified end users whose data transmissions warrant special consideration.

The Switch allows you to further tailor how priority tagged data packets are handled on your network. Using queues to manage priority tagged data allows you to specify its relative priority to suit the needs of your network. There may be circumstances where it would be advantageous to group two or more differently tagged packets into the same queue. Generally, however, it is recommended that the highest priority queue, Queue 1, be reserved for data packets with a priority value of 7. Packets that have not been given any priority value are placed in Queue 0 and thus given the lowest priority for delivery.

A weighted round robin system is employed on the Switch to determine the rate at which the queues are emptied of packets. The ratio used for clearing the queues is 4:1. This means that the highest priority queue, Queue 1, will clear 4 packets for every 1 packet cleared from Queue 0.

Remember, the priority queue settings on the Switch are for all ports, and all devices connected to the Switch will be affected. This priority queuing system will be especially beneficial if your network employs switches with the capability of assigning priority tags.

VLAN Description

A Virtual Local Area Network (VLAN) is a network topology configured according to a logical scheme rather than the physical layout. VLAN can be used to combine any collection of LAN segments into an autonomous user group that appears as a single LAN. VLAN also logically segment the network into different broadcast domains so that packets are forwarded only between ports within the VLAN. Typically, a VLAN corresponds to a particular subnet, although not necessarily.

VLAN can enhance performance by conserving bandwidth, and improve security by limiting traffic to specific domains.

A VLAN is a collection of end nodes grouped by logic instead of physical location. End nodes that frequently communicate with each other are assigned to the same VLAN, regardless of where they are physically on the network. Logically, a VLAN can be equated to a broadcast domain, because broadcast packets are forwarded to only members of the VLAN on which the broadcast was initiated.



NOTICE:

1. No matter what basis is used to uniquely identify end nodes and assign these nodes VLAN membership, packets cannot cross VLAN without a network device performing a routing function between the VLAN.
2. The Switch supports Port-based VLAN and IEEE 802.1Q VLAN. The port untagging function can be used to remove the 802.1 tag from packet headers to maintain compatibility with devices that are tag-unaware.
3. The Switch's default is to assign all ports to a single 802.1Q VLAN named DEFAULT_VLAN. As

new VLAN is created, the member ports assigned to the new VLAN will be removed from the DEFAULT_VLAN port member list. The DEFAULT_VLAN has a VID = 1.

Port-based VLAN

Port-based VLAN limit traffic that flows into and out of switch ports. Thus, all devices connected to a port are members of the VLAN(s) the port belongs to, whether there is a single computer directly connected to a switch, or an entire department.

On port-based VLAN, NIC do not need to be able to identify 802.1Q tags in packet headers. NIC send and receive normal Ethernet packets. If the packet's destination lies on the same segment, communications take place using normal Ethernet protocols. Even though this is always the case, when the destination for a packet lies on another switch port, VLAN considerations come into play to decide if the packet is dropped by the Switch or delivered.

IEEE 802.1Q VLANs

IEEE 802.1Q (tagged) VLAN are implemented on the Switch. 802.1Q VLAN require tagging, which enables them to span the entire network (assuming all switches on the network are IEEE 802.1Q-compliant).

VLAN allow a network to be segmented in order to reduce the size of broadcast domains. All packets entering a VLAN will only be forwarded to the stations (over IEEE 802.1Q enabled switches) that are members of that VLAN, and this includes broadcast, multicast and unicast packets from unknown sources.

VLAN can also provide a level of security to your network. IEEE 802.1Q VLAN will only deliver packets between stations that are members of the VLAN. Any port can be configured as either tagging or untagging. The untagging feature of IEEE 802.1Q VLAN allows VLAN to work with legacy switches that don't recognize VLAN tags in packet headers. The tagging feature allows VLAN to span multiple 802.1Q-compliant switches through a single physical connection and allows Spanning Tree to be enabled on all ports and work normally.

Any port can be configured as either tagging or untagging. The untagging feature of IEEE 802.1Q VLAN allow VLAN to work with legacy switches that don't recognize VLAN tags in packet headers. The tagging feature allows VLAN to span multiple 802.1Q-compliant switches through a single physical connection and allows Spanning Tree to be enabled on all ports and work normally.

Some relevant terms:

Tagging - The act of putting 802.1Q VLAN information into the header of a packet.

Untagging - The act of stripping 802.1Q VLAN information out of the packet header.

802.1Q VLAN Tags

The figure below shows the 802.1Q VLAN tag. There are four additional octets inserted after the source

MAC address. Their presence is indicated by a value of 0x8100 in the Ether Type field. When a packet's Ether Type field is equal to 0x8100, the packet carries the IEEE 802.1Q/802.1p tag. The tag is contained in the following two octets and consists of 3 bits of user priority, 1 bit of Canonical Format Identifier (CFI - used for encapsulating Token Ring packets so they can be carried across Ethernet backbones), and 12 bits of VLAN ID (VID). The 3 bits of user priority are used by 802.1p. The VID is the VLAN identifier and is used by the 802.1Q standard. Because the VID is 12 bits long, 4094 unique VLAN can be identified. The tag is inserted into the packet header making the entire packet longer by 4 octets. All of the information originally contained in the packet is retained.

802.1Q Tag

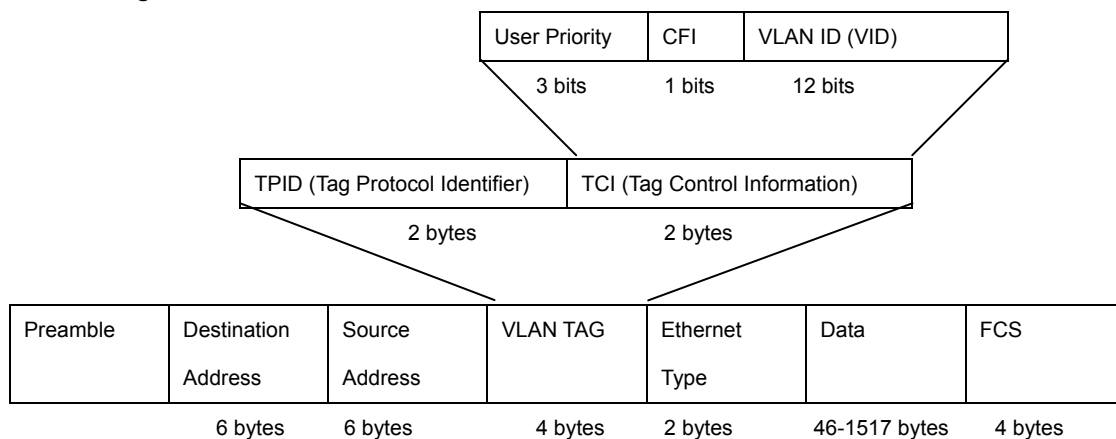

The Ether Type and VLAN ID are inserted after the MAC source address, but before the original Ether Type/Length or Logical Link Control. Because the packet is now a bit longer than it was originally, the Cyclic Redundancy Check (CRC) must be recalculated.

Adding an IEEE802.1Q Tag

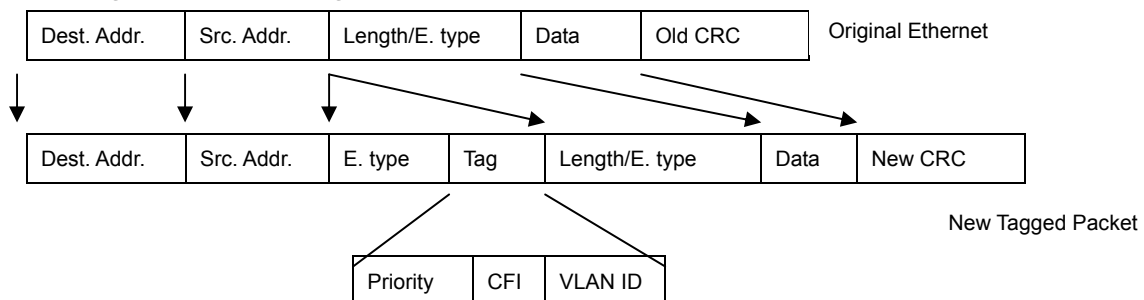

Port VLAN ID

Packets that are tagged (are carrying the 802.1Q VID information) can be transmitted from one 802.1Q compliant network device to another with the VLAN information intact. This allows 802.1Q VLAN to span network devices (and indeed, the entire network – if all network devices are 802.1Q compliant).

Every physical port on a switch has a PVID. 802.1Q ports are also assigned a PVID, for use within the switch. If no VLAN are defined on the switch, all ports are then assigned to a default VLAN with a PVID equal to 1. Untagged packets are assigned the PVID of the port on which they were received. Forwarding

decisions are based upon this PVID, in so far as VLAN are concerned. Tagged packets are forwarded according to the VID contained within the tag. Tagged packets are also assigned a PVID, but the PVID is not used to make packet forwarding decisions, the VID is.

Tag-aware switches must keep a table to relate PVID within the switch to VID on the network. The switch will compare the VID of a packet to be transmitted to the VID of the port that is to transmit the packet. If the two VID are different the switch will drop the packet. Because of the existence of the PVID for untagged packets and the VID for tagged packets, tag-aware and tag-unaware network devices can coexist on the same network.

A switch port can have only one PVID, but can have as many VID as the switch has memory in its VLAN table to store them.

Because some devices on a network may be tag-unaware, a decision must be made at each port on a tag-aware device before packets are transmitted – should the packet to be transmitted have a tag or not? If the transmitting port is connected to a tag-unaware device, the packet should be untagged. If the transmitting port is connected to a tag-aware device, the packet should be tagged.

Default VLANs

The Switch initially configures one VLAN, VID = 1, called "**default**." The factory default setting assigns all ports on the Switch to the "**default**". As new VLAN are configured in Port-based mode, their respective member ports are removed from the "default."

VLAN and Link aggregation Groups

In order to use VLAN segmentation in conjunction with port link aggregation groups, you can first set the port link aggregation group(s), and then you may configure VLAN settings. If you wish to change the port link aggregation grouping with VLAN already in place, you will not need to reconfigure the VLAN settings after changing the port link aggregation group settings. VLAN settings will automatically change in conjunction with the change of the port link aggregation group settings

4.7.1.2 VLAN Configuration

Port-based VLAN

Packets can only be broadcast among other members of the same VLAN group. Note all unselected ports are treated as belonging to the default system VLAN. If port-based VLAN are enabled, then VLAN-tagging is ignored.

1. On **VLAN Configuration** table, choose **Port-based VLAN**. Click on the "OK" button.

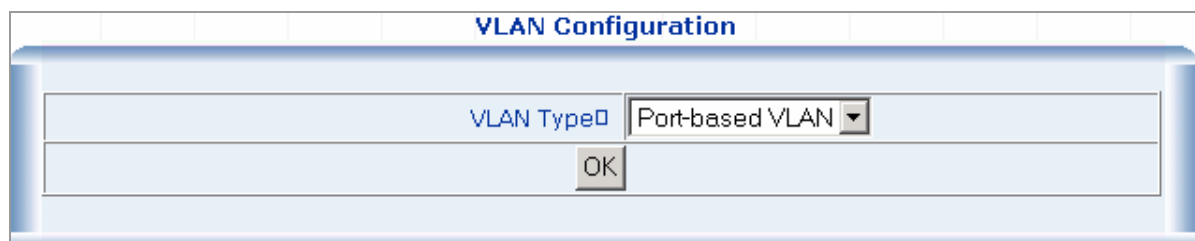

2. The main page then change to **Port-based VLAN** table, click on the “**Add/Modify**” button to create a new VLAN group.

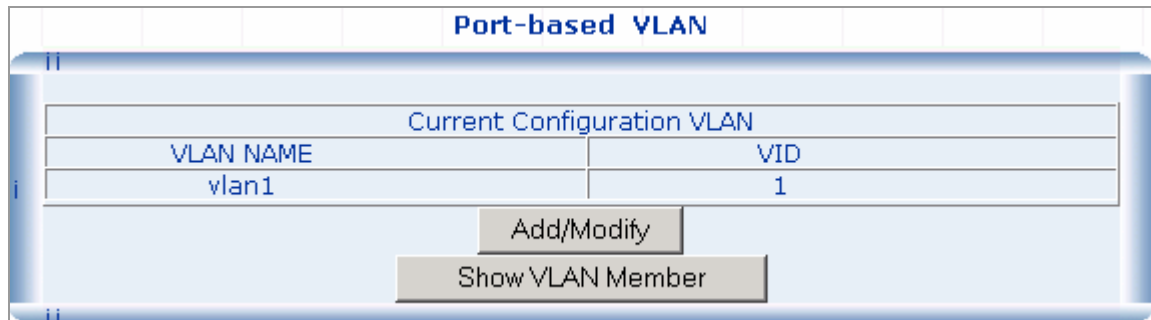

3. The **Port-based VLAN Configuration** table then pops up, enter the VLAN group ID, VLAN name and select the member ports for the VLAN.

4. Click the “**OK**” button to add the VLAN.

5. Select the ports in the **Port List** field and click on the Add button to add the member ports to the VLAN.

The selected VLAN member then shows in the **VLAN Member** field.

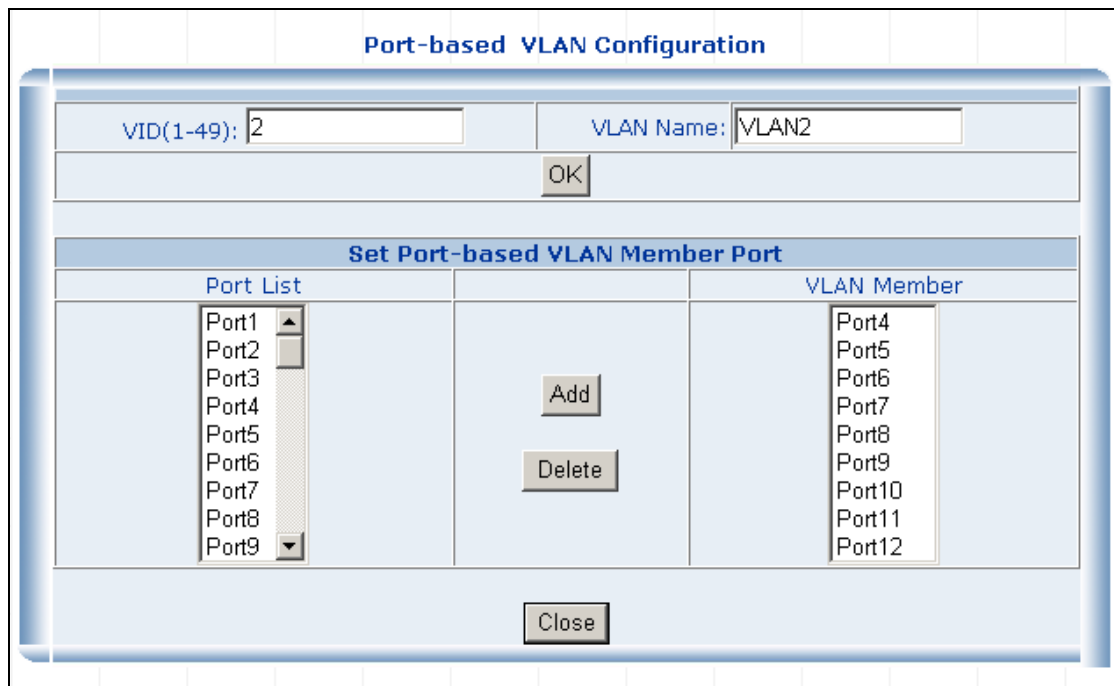

6. Click on the “**Close**” button and back to the **Port-based VLAN** main page.

The “**Show VLAN Member**” button is to list the valid VLANs. You can also remove the added VALN by click on this button.

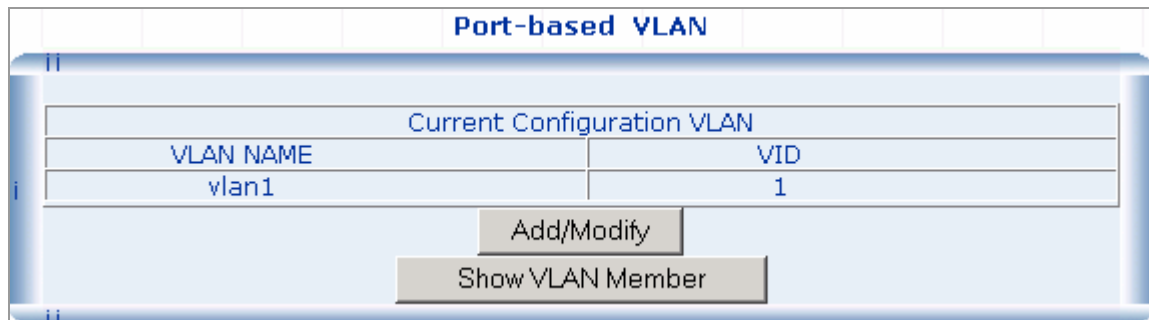

802.1Q VLAN

There are up to 256 configurable VLAN groups. By default when 802.1Q is enabled, all ports on the switch belong to default VLAN (VID 1). The default VLAN cannot be deleted.

Understand nomenclature of the Switch

Tagging and Untagging

Every port on an 802.1Q compliant switch can be configured as tagging or untagging.

- **Tagging:** Ports with tagging enabled will put the VID number, priority and other VLAN information into the header of all packets that flow into those ports. If a packet has previously been tagged, the port will not alter the packet, thus keeping the VLAN information intact. The VLAN information in the tag can then be used by other 802.1Q compliant devices on the network to make packet-forwarding decisions.
- **Untagging:** Ports with untagging enabled will strip the 802.1Q tag from all packets that flow into those ports. If the packet doesn't have an 802.1Q VLAN tag, the port will not alter the packet. Thus, all packets received by and forwarded by an untagging port will have no 802.1Q VLAN information. (Remember that the PVID is only used internally within the Switch). Untagging is used to send packets from an 802.1Q-compliant network device to a non-compliant network device.

Here pay attention to the explanation of “**Access**” and “**Trunk**”.

- **Access:** Ports will strip the 802.1Q tag from all packets that out of those ports. If the packet doesn't have an 802.1Q VLAN tag, the port will not alter the packet. Thus, all packets received by and forwarded by an untagging port will have no 802.1Q VLAN information. Untagging is used to send packets from an 802.1Q-compliant network device to a non-compliant network device.
- **Trunk:** Ports with tagging enabled will put the VID number, priority and other VLAN information into the header of all packets that out of those ports. If a packet has previously been tagged, the port will not alter the packet, thus keeping the VLAN information intact. The VLAN information in the tag can then be used by other 802.1Q compliant devices on the network to make packet forwarding decisions.

Port VID (PVID)

Set the port VLAN ID that will be assigned to untagged traffic on a given port. This feature is useful for accommodating devices that you want to participate in the VLAN but that don't support tagging. The

Switch allows each port to set one PVID, the range is 1~255, default PVID is 1. The PVID must be the same as the VLAN ID that the port was defined as belonging to in the VLAN group, or the untagged traffic will be dropped.

1. Select **802.1Q VLAN** in the **VLAN Type** field and click on the “OK” button.

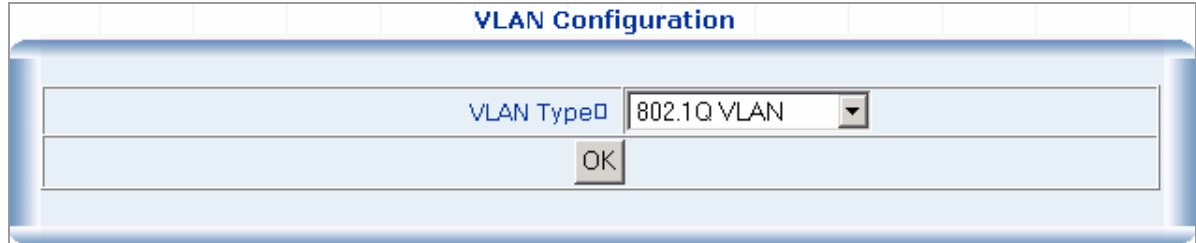

The screenshot shows a dialog box titled "VLAN Configuration". It features a dropdown menu labeled "VLAN Type" with "802.1Q VLAN" selected. Below the dropdown is an "OK" button.

The main page then changes to the **802.1Q VLAN** table which displays the VLAN configuration of each port.

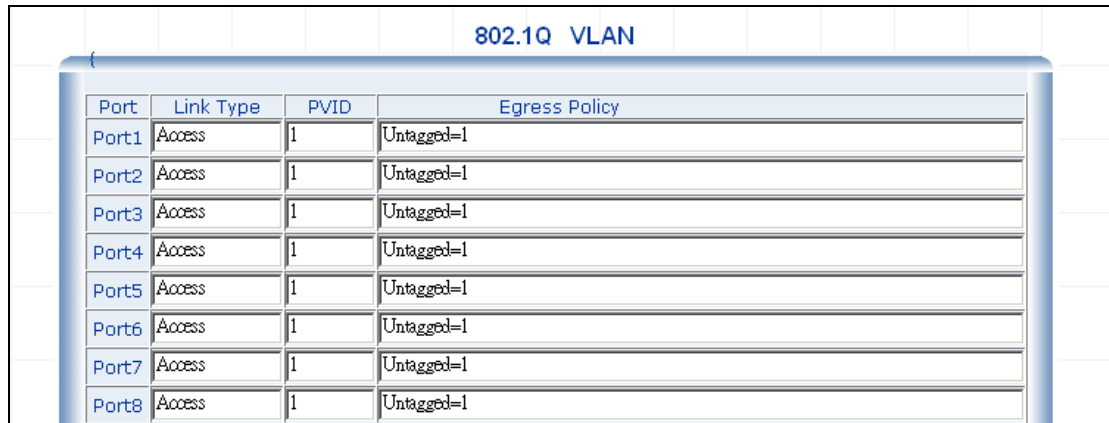

Port	Link Type	PVID	Egress Policy
Port1	Access	1	Untagged=1
Port2	Access	1	Untagged=1
Port3	Access	1	Untagged=1
Port4	Access	1	Untagged=1
Port5	Access	1	Untagged=1
Port6	Access	1	Untagged=1
Port7	Access	1	Untagged=1
Port8	Access	1	Untagged=1

2. If you want to configure port #2 to be in a VLAN other than default VLAN. Double click on “**port2**” to enter into VLAN port configuration window.

802.1Q VLAN Port Configuration---Port 2

Link Type: PVID:

Set Trunk Port for VLAN

VLAN Table		VLAN with The Trunk Port								
<table border="1" style="width: 100%; border-collapse: collapse;"> <thead> <tr> <th style="width: 15%;">VID</th> <th style="width: 85%;">VLAN NAME</th> </tr> </thead> <tbody> <tr> <td style="text-align: center;">1</td> <td>default vlan</td> </tr> </tbody> </table>	VID	VLAN NAME	1	default vlan	<input type="button" value="Add"/> <input type="button" value="Delete"/>	<table border="1" style="width: 100%; border-collapse: collapse;"> <thead> <tr> <th style="width: 15%;">VID</th> <th style="width: 85%;">VLAN NAME</th> </tr> </thead> <tbody> <tr> <td> </td> <td> </td> </tr> </tbody> </table>	VID	VLAN NAME		
VID	VLAN NAME									
1	default vlan									
VID	VLAN NAME									

Set VLAN's VID & Name

VID VLAN Name

3. Choose the **Link Type** in the drop drop down menu: **Access** or **Trunk**.

Note that if the **Access** type is chosen, it will strip the 802.1Q tag from all packets that out of this port. On the other hand, if the **Trunk** type is chosen, it will put the VID number, priority and other VLAN information into the header of all packets that out of this port.

4. Define the PVID for the port

Set the port VLAN ID that will be assigned to untagged traffic on a given port. This feature is useful for accommodating devices that you want to participate in the VLAN but that don't support tagging.

Link Type: PVID:

5. **Trunk configuration:** If the **Trunk** type is chosen, please follow the steps to set the Trunk of the port.

5.1 Add and define the names and VIDs for new VLANs. The VID number ranges from 2 to 4094. Fill the **VID** field and the **VLAN Name** field in the **Set VLAN's VID & Name** table and click on the "**Add/Modify**" button to save.

Set VLAN's VID & Name

VID VLAN Name

5.2 The added new VLAN then shows the the **VLAN Table** field in the **Set Trunk Port for VLAN** table.

Set Trunk Port for VLAN										
VLAN Table		VLAN with The Trunk Port								
<table border="1"> <thead> <tr> <th>VID</th> <th>VLAN NAME</th> </tr> </thead> <tbody> <tr> <td>1</td> <td>default vlan</td> </tr> <tr> <td>2</td> <td>VLAN2</td> </tr> </tbody> </table>	VID	VLAN NAME	1	default vlan	2	VLAN2	<input type="button" value="Add"/> <input type="button" value="Delete"/>	<table border="1"> <thead> <tr> <th>VID</th> <th>VLAN NAME</th> </tr> </thead> <tbody> </tbody> </table>	VID	VLAN NAME
VID	VLAN NAME									
1	default vlan									
2	VLAN2									
VID	VLAN NAME									

5.3 Select on the VLAN which you want to tag with in the **VLAN Table** field and click on the “**Add**” button to add. This will add the VLAN in to the **VLAN with The Trunk Port** field.

Set Trunk Port for VLAN										
VLAN Table		VLAN with The Trunk Port								
<table border="1"> <thead> <tr> <th>VID</th> <th>VLAN NAME</th> </tr> </thead> <tbody> <tr> <td>1</td> <td>default vlan</td> </tr> <tr style="background-color: #e0e0e0;"> <td>2</td> <td>VLAN2</td> </tr> </tbody> </table>	VID	VLAN NAME	1	default vlan	2	VLAN2	<input type="button" value="Add"/> <input type="button" value="Delete"/>	<table border="1"> <thead> <tr> <th>VID</th> <th>VLAN NAME</th> </tr> </thead> <tbody> </tbody> </table>	VID	VLAN NAME
VID	VLAN NAME									
1	default vlan									
2	VLAN2									
VID	VLAN NAME									

5.4 Click on the “**close**” button to close the VLAN port configuration table of port #2, and back to the 802.1Q main page.

5.5 Click on the “**Show VLAN Members**” button to show the VLAN members.

<input type="button" value="Show VLAN Members"/>
--

5.6 As shows in the following screen:

Show VLAN Member			
VID	VLAN Name	VLAN Member	Delete
1	vlan1	Port3.Port5.Port7.Port8.	<input type="button" value="Delete"/>
2	vlan2	Port1.Port2.Port4.Port6.	<input type="button" value="Delete"/>

4.7.2 MAC Address Bind

This function is based upon for the switch security. When you add one MAC Address is bind with one port. It remains in the switch's address table, regardless of whether the device is physically connected to the switch. This saves the switch from having to re-learn a device's MAC address after it has been

disconnected or powered-off from the network, and then reconnected at some time later. If the Network station is connected with one port want to control the switch, the station's MAC Address must be the same as one MAC Address

To bind the MAC Address, click on the **Security/MAC Address Binding** menu button, the main web page then shows the **MAC Address Bind** function table.

1. Fill the **MAC Address** field with MAC address in the format **"xx-xx-xx-xx-xx-xx "** and choose the port to bind the MAC Address in the **Port** field.
2. Click on the **"Add"** button.
3. To remove the MAC Address binded by the port. Simply click on the **"Delete"** button of the MAC Address in the **Show MAC Address Table**.

The screenshot shows the 'MAC Address Bind' web interface. At the top, there is a title 'MAC Address Bind'. Below it is a section titled 'Bind New MAC Address'. This section contains two input fields: 'MAC Address' with the value '00-E0-4F-48-3A-7E' and 'Port' with a dropdown menu set to 'Port1'. Below these fields is an 'Add' button. Underneath the 'Add' button is another section titled 'Show Mac Address Table'. This section contains a table with three columns: 'MAC Address', 'Port', and 'Delete'.

MAC Address Bind		
Bind New MAC Address		
MAC Address	Port	
00-E0-4F-48-3A-7E	Port1	
Add		
Show Mac Address Table		
MAC Address	Port	Delete

The screenshot shows the 'MAC Address Bind' web interface. At the top, there is a title 'MAC Address Bind'. Below it is a section titled 'Bind New MAC Address'. This section contains two input fields: 'MAC Address' which is empty and 'Port' with a dropdown menu set to 'Port1'. Below these fields is an 'Add' button. Underneath the 'Add' button is another section titled 'Show Mac Address Table'. This section contains a table with three columns: 'MAC Address', 'Port', and 'Delete'. The table has one row with the MAC Address '00-E0-4F-48-3A-7E', Port 'Port1', and a 'Delete' button.

MAC Address Bind		
Bind New MAC Address		
MAC Address	Port	
	Port1	
Add		
Show Mac Address Table		
MAC Address	Port	Delete
00-E0-4F-48-3A-7E	Port1	Delete

4.7.3 MAC Address Filtering

MAC address filtering allows the switch to drop unwanted traffic. Traffic is filtered based on the destination addresses.

To filter the MAC Address, click on the **Security/MAC Address Filtering** menu button, the main web page then shows the **MAC Address Filtering** function table.

1. Fill the **MAC Address** field with MAC address in the format **"xx-xx-xx-xx-xx-xx "**.
2. Click on the **"Add"** button to add.

3. To remove the MAC Address filtered by the port. Simply click on the “Delete” button of the MAC Address in the **Current Filtering MAC** Table.

MAC Address Filtering

Add New Mac Address	
MAC Address	
<input type="text" value="00-E0-4F-48-3A-7E"/>	
<input type="button" value="Add"/>	
Current Filtering MAC	
MAC Address	Delete

MAC Address Filtering

Add New Mac Address	
MAC Address	
<input type="text"/>	
<input type="button" value="Add"/>	
Current Filtering MAC	
MAC Address	Delete
00-E0-4F-48-3A-7E	<input type="button" value="Delete"/>

4.7.4 MAC Address Learning

The switch is able to disable MAC Address learning function on ports.

1. Fill the **Port List** field in the **MAC Address Learning** table and select Enable/Disable in the **MAC Address Learning** field.
2. Click on the “OK” button to save.

MAC Address Learning	
MAC Address Learning	
Port List(e.g. 1-3,7)	MAC Address Learning
<input type="text"/>	Disable ▾
OK	
Show Port Table	
Port	MAC Address Learning
Port1	Enable
Port2	Enable
Port4	Enable
Port6	Enable
Port7	Enable
Port8	Enable

4.7.5 MAC Address Aging Time

The Aging Time affects the learning process of the Switch. Dynamic forwarding table entries, which are made up of the source and destination MAC addresses and their associated port numbers, are deleted from the table if they are not accessed within the aging time.

The aging time can be from 30 to 1,000,000 seconds with a default value of 300 seconds. A very long aging time can result in dynamic forwarding table entries that are out-of-date or no longer exist. This may cause incorrect packet forward indecisions by the Switch.

If the Aging Time is too short however, many entries may be aged out too soon. This will result in a high percentage of received packets whose source addresses cannot be found in the forwarding table, in which case the switch will broadcast the packet to all ports, negating many of the benefits of having a switch.

Static forwarding entries are not affected by the aging time.

To set the Aging Time, enter the number in the **MAC Address Aging Time** field, and click on the “OK” button to save. The valid range is 30~1000 seconds. Default is 300 seconds.

MAC Address Aging Time Configuration	
MAC Address Aging Time(30-1000s):	<input type="text" value="300"/>
OK	

4.8 QoS

4.8.1 Understand QoS

Quality of Service (QoS) is an advanced traffic prioritization feature that allows you to establish control over network traffic. QoS enables you to assign various grades of network service to different types of traffic, such as multi-media, video, protocol-specific, time critical, and file-backup traffic.

QoS reduces bandwidth limitations, delay, loss, and jitter. It also provides increased reliability for delivery of your data and allows you to prioritize certain applications across your network. You can define exactly how you want the switch to treat selected applications and types of traffic.

You can use QoS on your system to:

- Control a wide variety of network traffic by:
- Classifying traffic based on packet attributes.
- Assigning priorities to traffic (for example, to set higher priorities to time-critical or business-critical applications).
- Applying security policy through traffic filtering.
- Provide predictable throughput for multimedia applications such as video conferencing or voice over IP by minimizing delay and jitter.
- Improve performance for specific types of traffic and preserve performance as the amount of traffic grows.
- Reduce the need to constantly add bandwidth to the network.
- Manage network congestion.

QoS Terminology

Classifier - classifies the traffic on the network. Traffic classifications are determined by protocol, application, source, destination, and so on. You can create and modify classifications. The Switch then groups classified traffic in order to schedule them with the appropriate service level.

DiffServ Code Point (DSCP) - is the traffic prioritization bits within an IP header that are encoded by certain applications and/or devices to indicate the level of service required by the packet across a network.

Service Level - defines the priority that will be given to a set of classified traffic. You can create and modify service levels.

Policy - comprises a set of "rules" that are applied to a network so that a network meets the needs of the business. That is, traffic can be prioritized across a network according to its importance to that particular business type.

QoS Profile - consists of multiple sets of rules (classifier plus service level combinations). The QoS profile is assigned to a port(s).

Rules - comprises a service level and a classifier to define how theSwitch will treat certain types of traffic.

Rules are associated with a QoS Profile (see above).

To implement QoS on your network, you need to carry out the following actions:

1. Define a service level to determine the priority that will be applied to traffic.
2. Apply a classifier to determine how the incoming traffic will be classified and thus treated by the Switch.
3. Create a QoS profile which associates a service level and a classifier.
4. Apply a QoS profile to a port(s).

4.8.2 QOS Configuration

QoS settings allow customization of packet priority in order to facilitate delivery of data traffic that might be affected by latency problems. The IEEE 802.1p Priority specification uses 8 priority levels to classify data packets. In 802.1p compliant devices, a tag inserted into the packet header is used to identify the priority level of data packets.

The Switch supports four kinds of Traffic classifiers: 802.1P/ Port/MAC/VLANs and four queues.



NOTE: COS: Priority classifiers of the Switch forward packet. COS range is from 0 to 7. Seven is the high class. Zero is the less class. The user may configure the mapping between COS and Traffic classifiers.

1. MAC-COS Mapping

QoS settings allow customization of MAC address to Traffic classifiers.

1. Fill the MAC Address field in the MAC-CoS Mapping Configuration Table in the In the format “**xx-xx-xx-xx-xx-xx** “.
2. Fill the mapping number in the **CoS (0-7)** field.
3. Click on the “**OK**” button to save.
4. To remove the MAC-CoS mapping item, simply click on the “**Delete**” button in the **Show MAC-CoS Mapping** table.

MAC-CoS Mapping		
MAC-CoS Mapping Configuration		
MAC Address	CoS (0-7)	
00-E0-4F-48-3A-7E	7	
OK		
Show MAC-CoS Mapping		
MAC Address	CoS	Delete

MAC-CoS Mapping		
MAC-CoS Mapping Configuration		
MAC Address	CoS (0-7)	
<input type="text"/>	<input type="text"/>	
<input type="button" value="OK"/>		
Show MAC-CoS Mapping		
MAC Address	CoS	Delete
00-E0-4F-48-3A-7E	7	<input type="button" value="Delete"/>

2. VLAN-COS Mapping

QoS settings allow customization of VLAN ID to Traffic classifiers

1. Fill the **VID (1-2094)** field in the **VLAN-CoS Mapping** Table.
2. Fill the mapping number in the **CoS (0-7)** field.
3. Click on the “**OK**” button to save.
4. To remove the VLAN-CoS mapping item, simply click on the “**Delete**” button in the **Show VLAN-CoS Mapping** table.

VLAN-CoS Mapping			
VLAN-CoS Mapping			
VID (1-4094)	CoS (0-7)		
<input type="text" value="255"/>	<input type="text" value="3"/>		
<input type="button" value="OK"/>			
Show VLAN-CoS Mapping			
VID	VLAN Name	CoS	Delete

VLAN-CoS Mapping

VLAN-CoS Mapping	
VID (1-4094)	CoS (0-7)
<input type="text"/>	<input type="text"/>
<input type="button" value="OK"/>	

Show VLAN-CoS Mapping			
VID	VLAN Name	CoS	Delete
255	vlan3	5	<input type="button" value="Delete"/>

3. 802.1p-CoS Mapping

QoS settings allow customization of packet priority in order to facilitate delivery of data traffic that might be affected by latency problems. The IEEE 802.1p Priority specification uses 8 priority levels to classify data packets. In 802.1p compliant devices, a tag inserted into the packet header is used to identify the priority level of data packets.

1. Fill the **802.1p Priority (0-7)** field in the **802.1p-priority-CoS Mapping Configuration Table**.
2. Fill the mapping number in the **CoS (0-7)** field.
3. Click on the **“OK”** button to save.

802.1p-priority-CoS Configuration

802.1p-priority-CoS Mapping Configuration	
802.1p Priority (0-7)	CoS (0-7)
<input type="text" value="2"/>	<input type="text" value="3"/>
<input type="button" value="OK"/>	

Show 802.1p-priority-CoS Mapping Table	
802.1p Priority	CoS
0	0
1	1
2	2
3	3
4	4
5	5
6	6
7	7

802.1p-priority-CoS Configuration

802.1p-priority-CoS Mapping Configuration	
802.1p Priority (0-7)	CoS (0-7)
<input style="width: 90%;" type="text"/>	<input style="width: 90%;" type="text"/>
<input type="button" value="OK"/>	
Show 802.1p-priority-CoS Mapping Table	
802.1p Priority	CoS
0	0
1	1
2	3
3	3
4	4
5	5
6	6
7	7

4. Port-COS Mapping

QoS settings allow customization of VLAN ID to Traffic classifiers

1. Fill the **Port List (e.g. 1-3,7)** field in the **port-based QoS Configuration Table**.
2. Fill the mapping number in the **CoS (0-7)** field.
3. Click on the **“OK”** button to save.

port-based QoS Configuration	
Port List(e.g. 1-3,7)	CoS (0-7)
<input style="width: 90%;" type="text" value="4"/>	<input style="width: 90%;" type="text" value="5"/>
<input type="button" value="OK"/>	
Show port-based QoS Table	
Port	CoS
1	0
2	0
4	0
6	0
7	0

5. CoS-Queue Mapping

1. Fill the **CoS (0-7)** field in the **CoS-Queue Mapping Configuration Table**.
2. Fill the mapping number in the **Queue (0-3)** field.
3. Click on the **“OK”** button to save.

CoS-Queue Mapping

CoS-Queue Mapping Configuration

CoS (0-7)	Queue (0-3)
<input style="width: 80%;" type="text"/>	<input style="width: 80%;" type="text"/>
<input type="button" value="OK"/>	

Show CoS-Queue Mapping Table

CoS	Queue
0	0
1	0
2	1
3	1
4	2
5	2
6	3
7	3

6. Queue Management

There are two rules for the Priority Queue: Weighted Round Robin (**WRR**) and **Always Hight**.

To configure Queue Rule, select the **Queue Policy** drop down menu in the **Queue Rule Configuration** table. And Click on the “**OK**” button to save.

Queue Rule Configuration

Queue Policy	WRR <input type="button" value="v"/>
<input type="button" value="OK"/>	

If the WRR was chosen as the Queue Policy, the page would show in the main page.

Queue Management

Queue Rule Configuration

Queue Policy	WRR <input type="button" value="v"/>
<input type="button" value="OK"/>	

Show Queue Weight

Queue	Weight
Queue 3	8
Queue 2	4
Queue 1	2
Queue 0	1

4.9 Multicast

4.9.1 IGMP Snooping

Theory

Computers and network devices that want to receive multicast transmissions need to inform nearby routers that they will become members of a multicast group. The Internet Group Management Protocol (IGMP) is used to communicate this information. IGMP is also used to periodically check the multicast group for members that are no longer active. In the case where there is more than one multicast router on a sub network, one router is elected as the 'queried'. This router then keeps track of the membership of the multicast groups that have active members. The information received from IGMP is then used to determine if multicast packets should be forwarded to a given sub network or not. The router can check, using IGMP, to see if there is at least one member of a multicast group on a given subnet work. If there are no members on a sub network, packets will not be forwarded to that sub network.

IGMP Versions 1 and 2

Multicast groups allow members to join or leave at any time. IGMP provides the method for members and multicast routers to communicate when joining or leaving a multicast group.

IGMP version 1 is defined in RFC 1112. It has a fixed packet size and no optional data.

The format of an IGMP packet is shown below:

IGMP Message Format

Octets

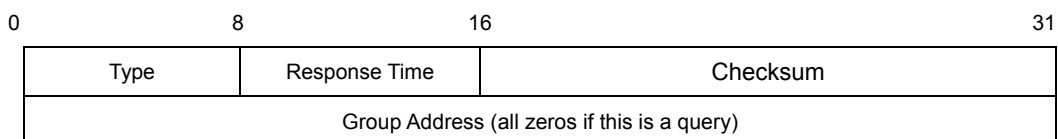

The IGMP Type codes are shown below:

Type Meaning

- 0x11** Membership Query (if Group Address is 0.0.0.0)
- 0x11** Specific Group Membership Query (if Group Address is Present)
- 0x16** Membership Report (version 2)
- 0x17** Leave a Group (version 2)
- 0x12** Membership Report (version 1)

IGMP packets enable multicast routers to keep track of the membership of multicast groups, on their respective sub networks. The following outlines what is communicated between a multicast router and a multicast group member using IGMP.

A host sends an IGMP “**report**” to join a group

A host will never send a report when it wants to leave a group (for version 1).

A host will send a “**leave**” report when it wants to leave a group (for version 2).

Multicast routers send IGMP queries (to the all-hosts group address: 224.0.0.1) periodically to see whether any group members exist on their sub networks. If there is no response from a particular group, the router assumes that there are no group members on the network.

The Time-to-Live (TTL) field of query messages is set to 1 so that the queries will not be forwarded to other sub networks.

IGMP version 2 introduces some enhancements such as a method to elect a multicast queried for each LAN, an explicit leave message, and query messages that are specific to a given group.

The states a computer will go through to join or to leave a multicast group are shown below:

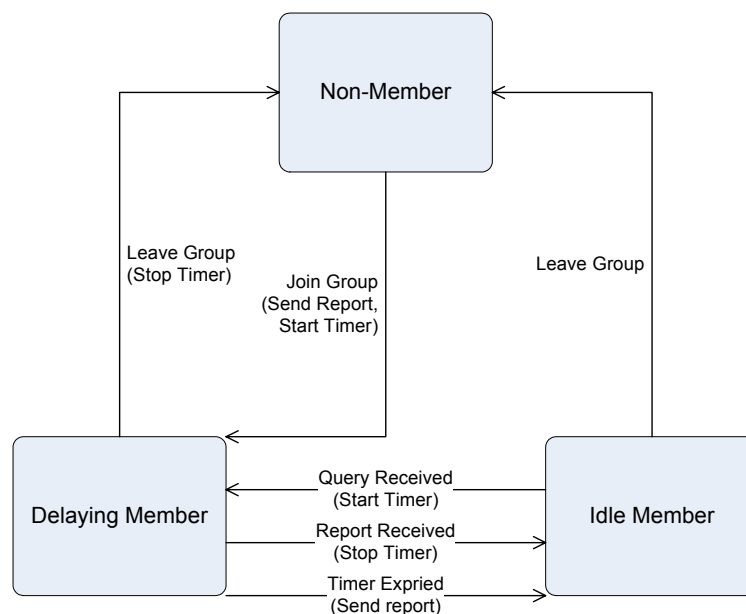

IGMP State Transitions

IGMP Snooping Configuration

The default status of the IGMP Snooping function is disabled. To turn on the IGMP Snooping, select “**Enable**” of the **IGMP Snooping Status** field and click on the “**OK**” button to save.

IGMP Snooping

IGMP Snooping Status:

Show The Multicast Group Table

Multicast	VID	Port

4.9.2 Static Routing Port

This function is to configure ports to be the member of IGMP Groups in VLANs.

To do this, fill the **Port List** field and the **VID** field for the static routing and click on the “**Add**” button to save.

Static Routing Port

Static Routing Port Configuration

Port List(e.g. 1-3,7)

VID(VLAN 0 means All VLAN)

Show Static Routing Port Table

Port	VID	VLAN Name	Type	Delete
Port3	2	Vlan 2	Static	<input type="button" value="Delete"/>

4.10 Port Analysis

4.10.1 Port Analysis

This function shows the statistical information of each port, it helps to diagnose the network malfunction.

The following example shows the statistic table of port #6.

Port Analysis

Port Selecting

Port:

Show Statistic Table

Statistic Item	Total	Average	Max
Tx bytes:	6577715	469836	469836
Tx packets:	22661	1618	1618
Rx bytes:	1357570	96969	96969
Rx packets:	11629	830	830
Rx Unicast packets:	11493	820	820
Rx Multicast packets:	0	0	0
Rx Broadcast packets:	136	9	9
Tx/Rx packets of 64 bytes:	22953	1639	1639
Tx/Rx packets of 65~127 bytes:	2594	185	185
Tx/Rx packets of 128~255 bytes:	2110	150	150
Tx/Rx packets of 256~511 bytes:	1956	139	139
Tx/Rx packets of 512~1023 bytes:	2444	174	174
Tx/Rx packets of 1024~1518 bytes:	2188	156	156
Rx correct packets of less than 64 bytes:	0	0	0
Rx correct packets of exceed 1518 bytes:	0	0	0
Rx error packets of less than 64 bytes:	0	0	0
Rx error packets of exceed 1518 bytes:	0	0	0

4.10.2 Port Mirror

Port Mirroring is a method of monitoring network traffic that forwards a copy of each incoming and/or outgoing packet from one port of a network switch to another port where the packet can be studied. It enables the manager to keep close track of switch performance and alter it if necessary.

Configuring the port mirroring by assigning a source port from which to copy all packets and a sniffer port where those packets will be sent.

Capture Port: Use this option to select the destination port for monitored traffic. This is the port that your network analyzer would be connected to.

Ingress Port: Duplicate the data transmitted from the source port and forward it to the Capture port.

Egress Port: Duplicate the data sent to the source and forward it to the Capture port.

Port Mirror

Flow Capture Configuration

Capture Port:	Port1 ▾
Capture Status:	Enable ▾
<input type="button" value="OK"/>	

Mirror Port Configuration

Ingress Port List(e.g. 1-3,7)	Egress Port List(e.g. 1-3,7)
<input type="text" value="5"/>	<input type="text" value="6"/>
<input type="button" value="OK"/>	

4.11 Storm Control

This function is to control the Broadcast Storm, Multicast Storm and Flooded Storm packet on each port. To configure the Storm Control, click on the **Storm Control** menu button. The web main page then shows the Storm Restricting function table.

1. Fill the **Port List** field in the **Broadcast Storm Restricting** table, select the type in the **Restricting Type** drop down menu and enter the packet size in the **Flow** field.
2. Click on the “**OK**” button to save.
3. To remove the Storm Restricting function on the port, simply click on the “**Delete**” button in the **Show Port Restricting Table** table.

Storm Restricting

Broadcast Storm Restricting

Port List(e.g.1-3,7)	Restricting Type	Flow(64~80000Kbps)
<input type="text"/>	Broadcast ▾	<input type="text"/>
<input type="button" value="Add"/>		

Show Port Restricting Table

Port	Restricting Type	Flow	Delete
1	Broadcast only	64	<input type="button" value="Delete"/>
1	Broadcast only	64	<input type="button" value="Delete"/>
3	Broadcast,Multicast And Flooded	256	<input type="button" value="Delete"/>

5. TROUBLE SHOOTING

This section is intended to help you solve the most common problems on the 8 10/100TX plus 100FX Exp. Slot managed POE switch.

5.1 Incorrect connections

The switch port can auto detect straight or crossover cable when you link switch with other Ethernet device. For the RJ-45 connector should use correct UTP or STP cable, 10/100Mbps port use 2 pairs twisted cable. If the RJ-45 connector is not correct pin on right position then the link will fail. For fiber connection, please notice that fiber cable mode and fiber module should be match.

5.1.1 Faulty or loose cables

Look for loose or obviously faulty connections. If they appear to be OK, make sure the connections are snug. IF that does not correct the problem, try a different cable.

5.1.2 Non-standard cables

Non-standard and miss-wired cables may cause numerous network collisions and other network problem, and can seriously impair network performance. A category 5-cable tester is a recommended tool for every 100Base-T network installation.

5.1.3 Improper Network Topologies

It is important to make sure that you have a valid network topology. Common topology faults include excessive cable length and too many repeaters (hubs) between end nodes. In addition, you should make sure that your network topology contains no data path loops. Between any two ends nodes, there should be only one active cabling path at any time. Data path loops will cause broadcast storms that will severely impact your network performance.

5.2 Diagnosing LED Indicators

The Switch can be easily monitored through panel indicators to assist in identifying problems, which describes common problems you may encounter and where you can find possible solutions.

IF the power indicator does turn on when the power cord is plugged in, you may have a problem with power outlet, or power cord. However, if the Switch powers off after running for a while check for loose power connections, power losses or surges at power outlet. IF you still cannot resolve the problem, contact your local dealer for assistance.

5.2.1 Cabling

RJ-45 ports: use unshielded twisted-pair (UTP) or shield twisted-pair (STP) cable for RJ-45 connections: 100Ω Category 3, 4 or 5 cable for 10Mbps connections or 100Ω Category 5 cable for 100Mbps connections. Also be sure that the length of any twisted-pair connection does not exceed 100 meters (328 feet).

6. APPENDIX

6.1 Console Port Pin Assignments

The DB-9 serial port on the front panel is used to connect to the switch for out-of-band console configuration. The console menu-driven configuration program can be accessed from a terminal or a PC running a terminal emulation program. The pin assignments used to connect to the serial port are provided in the following tables.

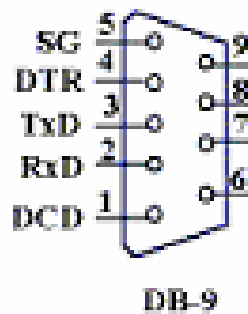

DB-9 Console Port Pin Numbers

DB-9 Port Pin Assignments

EIA Circuit	CCITT Signal	Description	Switch's DB9 DTE Pin #	PC DB9 DTE Pin #
BB	104	RxD (Received Data)	2	2
BA	103	TxD (Transmitted Data)	3	3
AB	102	SGND (Signal Ground)	5	5

Console Port to 9-Pin DTE Port on PC

Switch's 9-Pin Serial Port	CCITT Signal PC's 9-Pin	DTE Port
2 RXD	<-----RXD -----	3 TxD
3 TXD	-----TXD ----->	2 RxD
5 SGND	-----SGND -----	5 SGND

Cable Types and Specifications

Cable	Type	Max. Length	Connector
10BASE-T	Cat. 3, 4, 5 100-ohm	UTP 100 m (328 ft)	RJ-45
100BASE-TX	Cat. 5 100-ohm UTP	100 m (328 ft)	RJ-45
100BASE-FX	50/125 or 62.5/125 micron core multimode fiber (MMF)	2 km (1.24 miles)	SC or ST

6.2 100BASE-TX/10BASE-T Pin Assignments

With 100BASE-TX/10BASE-T cable, pins 1 and 2 are used for transmitting data, and pins 3 and 6 for receiving data.

RJ-45 Pin Assignments

Pin Number	Assignment
1	Tx+
2	Tx-
3	Rx+
6	Rx-

Note: "+" and "-" signs represent the polarity of the wires that make up each wire pair.

All ports on this switch support automatic MDI/MDI-X operation, you can use straight-through cables for all network connections to PCs or servers, or to other switches or hubs. In straight-through cable, pins 1, 2, 3, and 6, at one end of the cable, are connected straight through to pins 1, 2, 3 and 6 at the other end of the cable. The table below shows the 10BASE-T/ 100BASE-TX MDI and MDI-X port pin outs.

Pin MDI-X	Signal Name	MDI Signal Name
1	Receive Data plus (RD+)	Transmit Data plus (TD+)
2	Receive Data minus (RD-)	Transmit Data minus (TD-)
3	Transmit Data plus (TD+)	Receive Data plus (RD+)
6	Transmit Data minus (TD-)	Receive Data minus (RD-)