

M3097G
IMAGE SCANNER
OEM MANUAL

REVISION RECORD

Edition	Date published	Revised contents
01	Apr., 1993	
02	Feb., 1996	Gray scale added
Specification No.: 50FH5043E		

The contents of this manual is subject to change without prior notice.

All Rights Reserved,
Copyright © 1993, 1996 FUJITSU LIMITED

This page is intentionally left blank.

CONTENTS

	page
CHAPTER 1 GENERAL	1-1
1.1 General	1-1
1.2 Features	1-3
1.3 Part Names and Functions	1-4
1.3.1 Exterior view of image scanner	1-4
1.3.2 Functions of each part	1-5
CHAPTER 2 SPECIFICATIONS	2-1
2.1 Function Specifications	2-1
2.2 Physical Specifications	2-3
2.3 Optional Circuit Feature	2-4
2.3.1 Image processing circuit II (IPC II)	2-4
2.3.1.1 Dynamic threshold function	2-4
2.3.1.2 Image processing function	2-5
CHAPTER 3 CONFIGURATION	3-1
3.1 Outer Dimensions	3-1
3.2 Circuit Configuration	3-3
3.3 Operator panel	3-4
CHAPTER 4 INTERFACE	4-1
4.1 Physical Specifications	4-3
4.2 SCSI Bus	4-6
4.2.1 System configuration	4-6
4.2.2 Bus signals	4-7
4.2.3 Bus signal drive conditions	4-8
4.3 Bus Phases	4-9
4.3.1 BUS FREE phase	4-12
4.3.2 ARBITRATION phase	4-13
4.3.3 SELECTION phase	4-15
4.3.4 RESELECTION phase	4-16
4.3.5 INFORMATION TRANSFER phases	4-17

4.4	Commands	4-20
4.4.1	RESERVE UNIT command	4-22
4.4.2	RELEASE UNIT command	4-24
4.4.3	INQUIRY command	4-25
4.4.4	REQUEST SENSE command	4-29
4.4.5	SEND DIAGNOSTIC command	4-34
4.4.6	TEST UNIT READY command	4-36
4.4.7	SET WINDOW command	4-37
4.4.8	SET SUBWINDOW command	4-56
4.4.9	OBJECT POSITION command	4-64
4.4.10	SEND command	4-68
4.4.11	READ command	4-73
4.4.12	MODE SELECT (6)	4-79
4.4.13	MODE SENSE (6)	4-84
4.5	Status: STATUS phase (target → initiator)	4-88
4.6	Messages	4-89
4.6.1	ATN detection	4-89
4.6.2	Message types	4-89
4.7	Command Sequence	4-97
4.7.1	Initial sequence	4-97
4.7.2	Command sequence to read	4-98
4.7.3	READ command sequence	4-99
4.7.3.1	Single READ (without CMP II option: disconnect disabled)	4-99
4.7.3.2	Single READ (with CMP II option: disconnect disabled)	4-100
4.7.3.3	Single READ (with CMP II option: disconnect enabled)	4-101
4.7.3.4	Multiple READ (with CMP II option: disconnect disabled)	4-102
4.7.3.5	Multiple READ (with CMP II option: disconnect enabled)	4-103
4.8	Status Transition of Logical Unit	4-105
4.9	Error Table	4-106
4.10	Items for Specifying Window and Subwindow	4-107

APPENDIX A PAPER SPECIFICATIONS	A-1
A.1 Paper Size	A-2
A.2 Paper Conditions	A-3
A.2.1 Paper type	A-3
A.2.2 Ream weight	A-3
A.2.3 Paper quality	A-3
A.2.4 ADF document feeder capacity	A-4
A.3 Paper Limitations (for ADF Reading Only)	A-5
A.3.1 Areas that must not be perforated	A-5
A.3.2 Reverse unprintable areas	A-6
A.4 Grounding Color Area	A-7
A.5 Job Separation Sheet	A-8
A.5.1 Shape	A-8
A.5.2 Paper conditions	A-8
 APPENDIX B ADF SCANNING SPEED	 B-1
 APPENDIX C DROP-OUT COLOR	 C-1
C.1 Print Density Measurement	C-1
C.2 Drop-out Color	C-2
 APPENDIX D DIFFERENCES BETWEEN THE M3097G AND M3096G IMAGE SCANNERS	 D-1
D.0 Preface	D-1
D.1 Enhanced Functions and Functional Differences	D-2
D.1.1 Functions added	D-3
D.1.1.1 Paper size detection	D-3
D.1.1.2 Job separation sheet detection	D-5
D.1.1.3 Error diffusion	D-8
D.1.1.4 Contrast	D-8
D.1.1.5 Gamma correction	D-8
D.1.1.6 Dynamic threshold	D-9
D.1.1.7 Lamp timer function	D-10
D.1.1.8 Added sense code	D-10
D.2 Supplement	D-11
D.2.1 Unified terminology	D-11
D.2.2 Corrections	D-11

D.2.3	Notes on compatibility	D - 12
D.2.3.1	Resolution	D - 12
D.2.3.2	Brightness	D - 13
D.2.3.3	Threshold	D - 13
D.2.3.4	Downloaded dither pattern and Brightness	D - 13
D.2.3.5	Simplified DTC	D - 14

FIGURES

	page
1.1 M3097G outer view	1 – 2
1.2 M3097G part names	1 – 4
3.1 Outer dimensions of M3097G	3 – 2
3.2 Function block diagram	3 – 3
3.3 M3097G operator panel	3 – 4
4.1 Pin assignment	4 – 5
4.2 Phase sequence	4 – 10
A.1 Paper size specification	A – 2
A.2 Areas that must not be perforated	A – 5
A.3 Reverse unprintable areas	A – 6
A.4 Grounding color area	A – 7
C.1 Spectrum band	C – 2
D.1.1 Command sequence	D – 3

TABLES

	page
2.1 Function specifications	2 – 1
2.2 Physical specifications	2 – 3
2.3 Image processing function	2 – 5
3.1 Lamp functions	3 – 4
4.1 SCSI physical specifications	4 – 4
4.2 Bus phases vs. signal drive sources	4 – 8
4.3 Method of driving the interface signal	4 – 9
4.4 Signal delay times definition	4 – 10
4.5 INFORMATION TRANSFER phase type	4 – 17
4.6 Commands	4 – 21
D.1.1 Added functions	D – 2
D.1.2 Functional differences	D – 2

CHAPTER 1 GENERAL

1.1	General
1.2	Features
1.3	Part Names and Functions

1.1 General

M3097G image scanners produce excellent electronic images from documents using the high quality optical image scanning technology and output to the host system.

The M3097G can scan a single page (including a page of a book) of a double-letter size (17 in.×11 in.) or A3 size (420 mm×297mm) in maximum on the standard flat-bed. The M3097G has an Automatic Document Feeder (ADF) that can accommodate up to 100 pages.

The M3097G outputs only binary data on the Small Computer System Interface (SCSI).

Figure 1.1 shows outer view of this scanner.

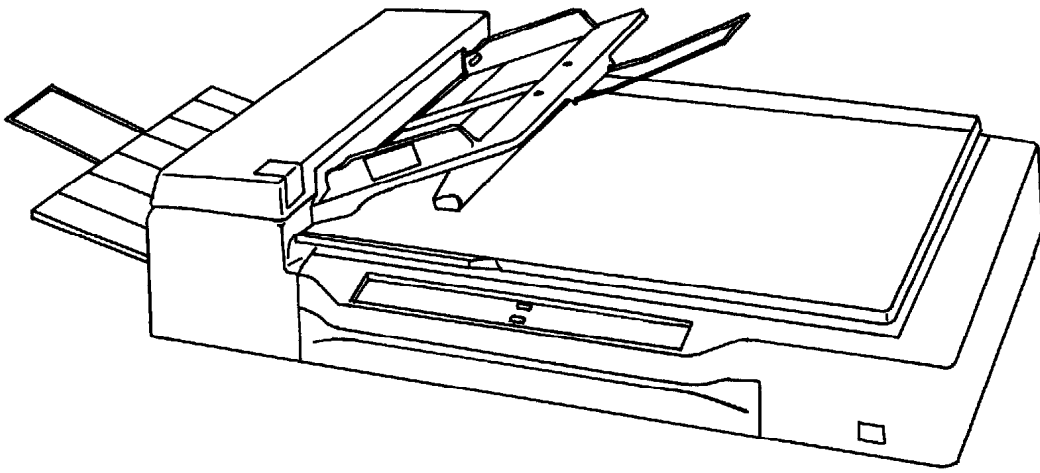

Figure 1.1 M3097G outer view

1.2 Features

(1) Fast reading

This scanner can read data about twice as fast as the M3096G.

For flatbed reading: 1.3 seconds (A4, 200 dpi) (M3096G: 2.3 seconds)

For ADF reading: 36 pages per minute (A4, 200 dpi) (M3096G: 18 pages per minute)

(2) Large-capacity document feeder

Up to 100 pages (A4, 55-kg continuous forms) can be loaded into the document feeder. (M3096G: Up to 50 pages)

(3) High-quality image

This scanner uses a compact optical system that provides sharper focus. Furthermore, the use of new LSI chips produces finer images.

(4) New image processing

The standard version of this scanner has error diffusion function. Dithering or error diffusion can be applied to those areas judged to be photographs by automatic separation (image processing II option).

(5) Compact

This scanner is small and light. (Its size is almost the same as that of the M3096G)

1.3 Part Names and Functions

This section shows the exterior view of image scanner. This section also provides names of each part and describes their functions.

1.3.1 Exterior view of image scanner

The image scanner can read a document of A3 or double-letter size at maximum.

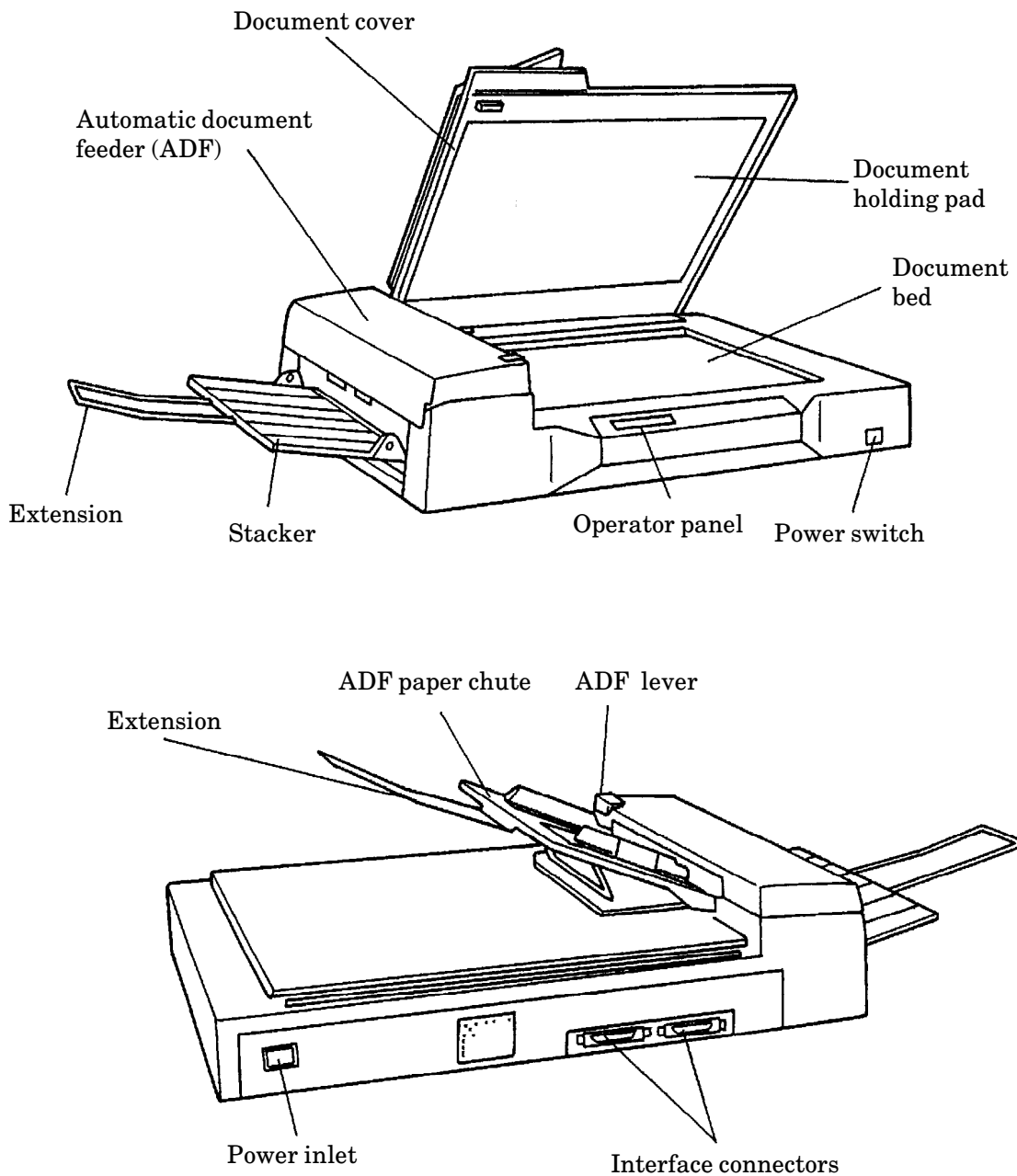

Figure 1.2 M3097G part names

1.3.2 Functions of each part

Document cover:	Closed over and holds a document to be read.
Document bed:	A document to be read is placed on the bed also called Flatbed (FB).
Document holding pad:	Presses a document to the document bed.
Automatic document feeder (ADF):	Automatically feeds documents to the reading position.
Stacker:	Stacks the read documents.
Extension:	Keeps the stacked documents from overhanging.
Power switch:	Turns the power on or off.
Operator panel:	Used to control image scanner operations. See the next section for details of the functions.
ADF paper chute:	Holds the documents to be fed by the automatic document feeder.
ADF lever:	Opens or closes the automatic document feeder to remove documents jammed in the feeder.
Power inlet:	To be connected to an AC power outlet with the power cable.
Interface connectors:	To be connected to the host system with interface cables.

This page is intentionally left blank.

CHAPTER 2 SPECIFICATIONS

<p>2.1 Function Specifications</p> <p>2.2 Physical Specifications</p> <p>2.3 Optional Circuit Feature</p>
--

2.1 Function Specifications

Table 2.1 Function specifications (1/2)

No.	Item	Specification	
1	Technology	CCD image sensor	
2	Operating method	Flatbed + ADF (automatic document feeder)	
3	Document size	Flatbed	MAX 297 × 432 mm
		ADF	MAX 297 × 432 mm MIN 105 × 148 mm
4	Light source	Green fluorescent lamp	
5	ADF capacity	MAX 100 (55 kg/continuous forms, A4 paper)	
6	Resolution	Horizontal scanning	400 dpi
		Vertical scanning	400, 300, 240, 200 dpi
7	Gray scale	256 steps	
8	Interface	SCSI-II	
9	Scanning speed	A4/200 dpi: 1.3 s A3/400 dpi: 3.7 s	
10	Output resolution	Standard	400, 300, 240, 200 dpi (For horizontal scanning and vertical scanning)
		If the image processing II option is installed	50 dpi to 1600 dpi (Horizontal scanning and vertical scanning are independent.)

Table 2.1 Functional specifications (2/2)

No.	Item	Specification	
11	Binarization and halftone function	Standard	Fixed binarization (Line art) Dither (Halftone) Error diffusion (Halftone)
		Image processing II option installed	Automatic separation Image emphasis Outline extraction Mirror image Reverse image Simplified dynamic threshold Dynamic threshold Smoothing Filtering Noise removing
12	Compression	Standard	Non
		CMP II option installed	MH, MR, or MMR
13	Image memory	Standard	Non
		CMP II option installed	4 MB

2.2 Physical Specifications

Table 2.2 Physical specifications

No.	Item		Specification
1	Dimensions (mm)	Height	173
		Width	696
		Depth	497
2	Weight (kg)		25
3	Power requirements	Voltage (VAC)	100 to 120, 220 to 240 VAC $\pm 10\%$
		Phase	Single
		Frequency	50/60 Hz $+2\%$ -4%
4	Power consumption (VA)		150 or less
5	Surge current (A)		30 or less
6	Momentary power failure		100% 0.5 Hz
7	Leakage current (mA)		1 or less
8	Dielectric strength		AC 1 KV or more for one minute or more (between FG and AG lines)
9	AC line noise		Voltage 1.2 KV pulse duration 5 μ s
10	Temperature (°C)	Operating	5 to 35
		Nonoperating	-20 to +60
11	Relative humidity (%)	Operating	20 to 80 (no condensation)
		Nonoperating	8 to 95 (no condensation)
12	Vibration (G)	Operating	0.2
		Nonoperating	0.4
13	Indication (%)	Operating	5
		Nonoperating	10
14	ESD (KV)		8 or more
15	Acoustic noise (dBA)	Operating	53 or less (ISO DIS 9296)
		Nonoperating	40 or less (ISO DIS 9296)

2.3 Optional Circuit Feature

The following option is provided for this scanner:

- Image processing circuit II (M3097E0191)

For the details, refer to Subsection 2.3.1.

- CMP II (M3097G0196)

2.3.1 Image processing circuit II (IPC II)

This option has the dynamic threshold function and image processing function.

2.3.1.1 Dynamic threshold function

The main purpose of this function is to read handwritten characters.

Handwritten character recognition preprocessing involves specifying required values for threshold curve setting, smoothing mode, and filtering mode.

Noise removal reduces noise often found in images after dynamic threshold processing.

Threshold curve setting, smoothing mode, filtering mode, and noise removal are all dynamic threshold circuit (DTC) functions.

(1) Threshold curve setting

The contrast level of the dynamic threshold circuit can be changed with setting 3 bits (8 levels).

(2) Smoothing mode

The convex portion of the segment is removed and the concave portion is filled up to smooth the segment.

(3) Filtering mode

(a) Ball-point pen mode

This mode is used when this scanner is used as the input device of OCR system. When using writing materials caused inter-ommission, e.g. ball-point pen, the density of the omission portion is increased according to the density of surrounding portion to get the picture does not have inter-ommission.

(b) Normal mode

This mode is used when using writing materials other than above.

(4) Noise removal

Among black-dots in the binary picture code, the black-dot for the noise is changed to white-dot.

2.3.1.2 Image processing function

Table 2.3 Image processing function

No.	Function name	Details function
1	Automatic separation (Line-drawing/Photo) automatic separation	Recognizes the photo area and Line-drawing area in one scanning automatically, and outputs data with applying dither processing or error diffusion for the photo and the binarizing for the line-drawing.
2	Outline extraction	Extracts the outline of the Line-drawing such as a thick character.
3	Image emphasis	Emphasizes the black-white contrast to raise the contrast.
4	Overlay (*1)	Overlays the pattern on the scanned data and make the overlaid black data to white data.
5	Reverse image (White/black conversion)	Converts white into black and black into white of read data (binary data).
6	Mirror image	Turns over the both sides of read data.
7	Simplified dynamic threshold	Changes the slice level of the binarizing according to the density of the document.
8	Zooming	Magnifies or reduces the image data in the range between 25% and 400% with 1% step.
9	Subwindow	4 Subwindow can be specified on Main window.

The functions above are all image processing circuit (IPC) functions.

*1 M3097G does not support overlay function.

This page is intentionally left blank.

CHAPTER 3 CONFIGURATION

- | |
|---|
| <p>3.1 Outer Dimensions</p> <p>3.2 Circuit Configuration</p> <p>3.3 Operator Panel</p> |
|---|

3.1 **Outer Dimensions**

Figure 3.1 shows the outer dimensions of M3097G.

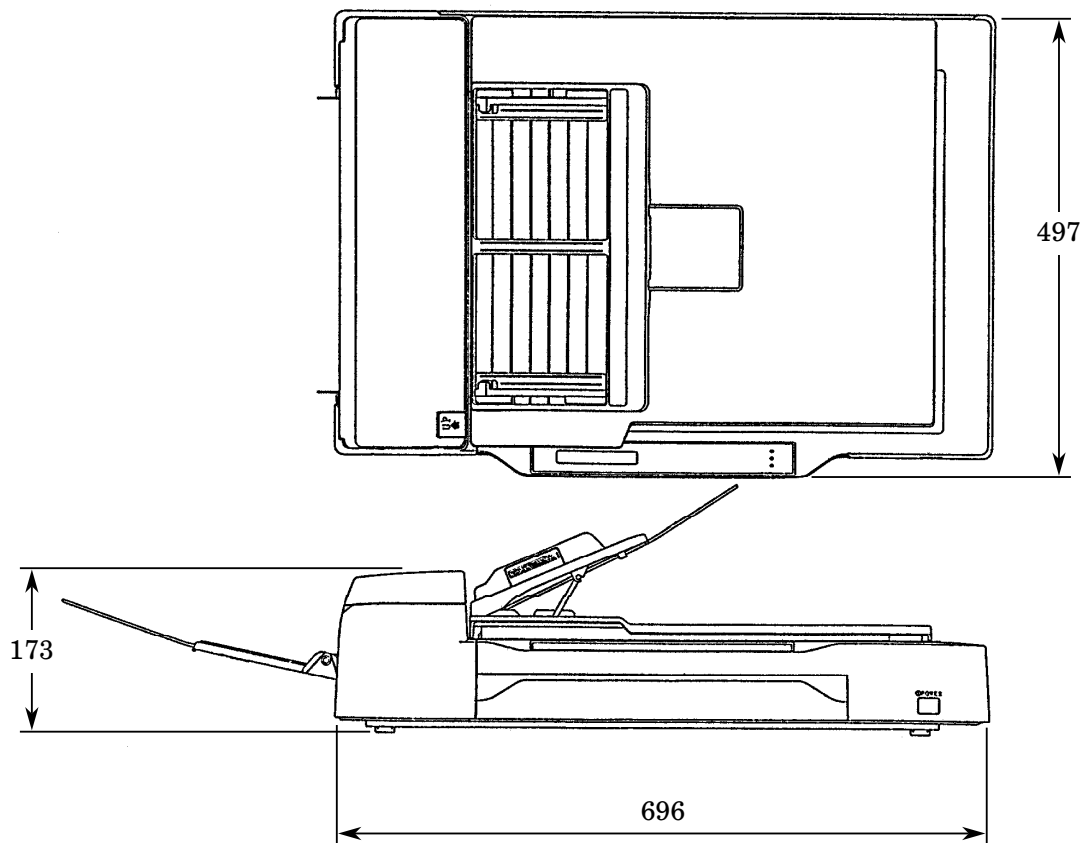

Unit: mm

Figure 3.1 Outer dimensions of M3097G

3.2 Circuit Configuration

This scanner uses CCD image sensor scanning system. This scanner consists of following sections;

- Optical system (including fluorescent lamp, lenses, and CCD sensor)
- Video circuit (including amplifier and A/D converter)
- Scanner driver (including stepping motor and motor driver circuit)
- Control circuit (MPU circuit)
- Power section

Figure 3.2 is the function block diagram of this scanner.

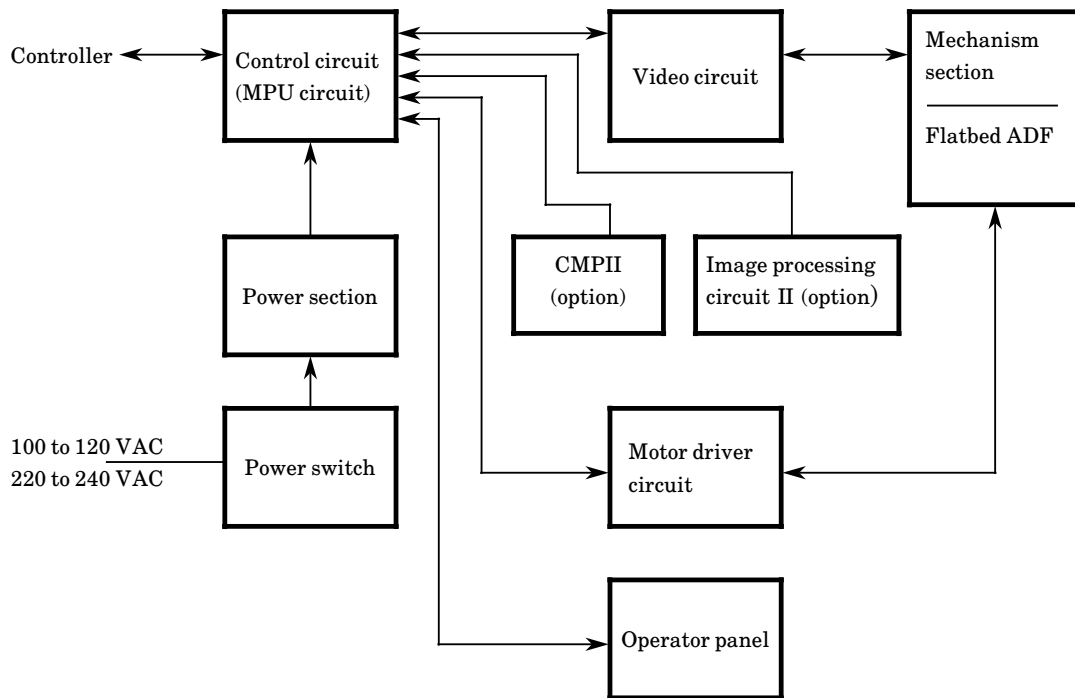

Figure 3.2 Function block diagram

3.3 Operator panel

Figure 3.3 shows the operator panel and Table 3.1 shows lamp functions.

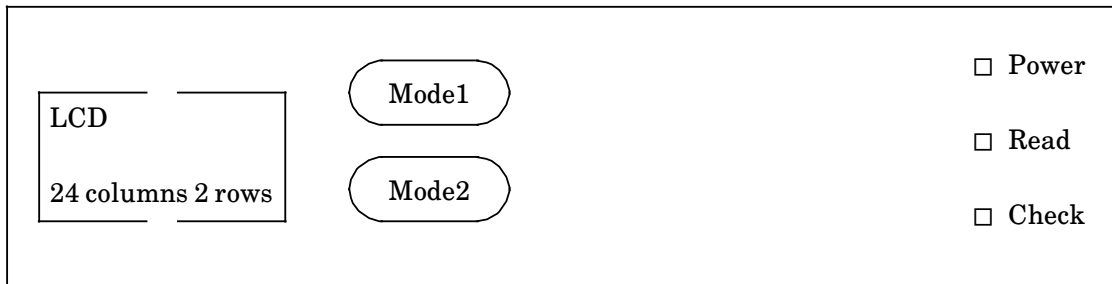

Figure 3.3 M3097G operator panel

Table 3.1 Lamp functions

Lamp name	Color	Functions
Power	Green	This lamp lights when the power is on.
Read	Green	This lamp lights during reading.
Check	Yellow	This lamp lights when an unrecoverable error occurs. This lamp brinks when a paper jam occurs in ADF. After jammed paper is removed and ADF cover is closed, this lamp goes off.

CHAPTER 4 INTERFACE

4.1	Physical Specifications
4.2	SCSI Bus
4.3	Bus Phases
4.4	Commands
4.5	Status
4.6	Messages
4.7	Command Sequence
4.8	Status Transition of Logical Unit
4.9	Error Table
4.10	Items for Specifying Window and Subwindows

This image scanner and the host are connected via an 8-bit parallel interface. The interface follows the ANSI (American National Standards Institute) SCSI 2 (Small Computer System Interface 2) Revision 10c.

This chapter provides an overview of SCSI (minimum information necessary for understanding this scanner), as well as descriptions peculiar to the scanner. For details of SCSI, refer to the ANSI standard.

The following terms are needed to understand this section.

- **SCSI device:** A host adapter or a target controller that can be attached to the SCSI bus
- **Initiator:** An SCSI device (usually a host system) that requests an I/O process to be performed by another SCSI device (a target)
- **Target:** An SCSI device that performs an operation requested by an initiator
- **Logical unit:** A physical or virtual peripheral device that is addressable through a target

Range of support

- (1) System configuration

This scanner operates under the multiinitiator, multitarget environment. An initiator function is not provided. This scanner incorporates an integrated target and logical unit (image scanner).

SCSI ID: 0 to 7, variable by EEPROM: default is 5.

Logical unit number (LUN): 000, fixed

(2) Bus phases

All phases are supported.

(3) Commands

The following commands are supported by this scanner:

- INQUIRY
- OBJECT POSITION
- MODE SELECT
- MODE SENSE
- READ
- RELEASE UNIT
- REQUEST SENSE
- RESERVE UNIT
- SEND
- SEND DIAGNOSTIC
- SET SUBWINDOW
- SET WINDOW
- TEST UNIT READY

A control byte is not supported. If the value other than X'00' is specified, an error is generated.

(4) Statuses

The following statuses are supported by this scanner:

- BUSY
- CHECK CONDITION
- GOOD
- RESERVATION CONFLICT

(5) Messages

The following messages are supported by this scanner:

- ABORT
- BUS DEVICE RESET
- COMMAND COMPLETE
- DISCONNECT
- IDENTIFY
- INITIATOR DETECTED ERROR
- MESSAGE PARITY ERROR
- MESSAGE REJECT
- NO OPERATION
- RESTORE POINTERS
- SAVE DATA POINTER

(6) Others

The bits and fields for which the word “Reserved” is described are checked. For a non-zero, an error is returned.

4.1 Physical Specifications

The devices linked to this interface are daisy-chained with each other. A terminator is attached to the ends of the interface. Interface specifications are shown below.

(1) Connection

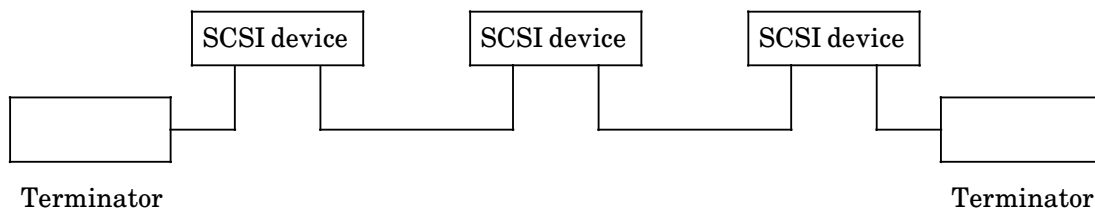

Note:

Use shielded interface cable to avoid unintentional errors.

(2) Physical specifications

Table 4.1 SCSI physical specifications

Item		Specification
Driver/Receiver		Single-ended
Connector		50 Contact Shielded Low Density
Cable	Max. cable length	6 m
	Characteristic impedance	132 Ω
	Cable type	25 signal twisted pair
	Stub wire	≤ 0.1 mm (from main cable in scanner to internal wiring)
Signal level	Terminator	See the figure under (3).
	Driver/receiver	Open collector or three- state driver
	Output characteristics	Low level (true) = 0.0 to 0.5 VDC High level (false) = 2.5 to 5.25 VDC Output current = 48 mA (corresponding output voltage ≤ 0.5 V)
	Input characteristics	Low level (true) = 0.0 to 0.8 VDC High level (false) = 2.0 to 5.25 VDC Input load = -0.4 mA max. (at 0.4 V input voltage) Input hysteresis = 0.2 VDC min.
Connector pin assignments for signal lines		See (4).

(3) Termination

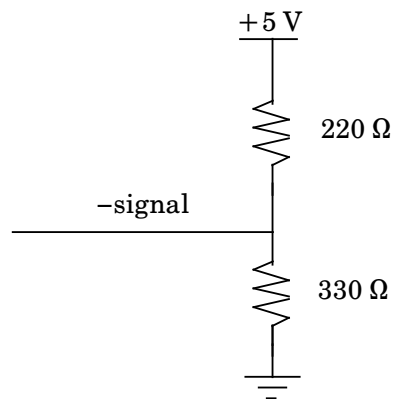

(4) Pin assignments

Signal name	Pin number		Signal name
GND	1	26	-DB (0)
GND	2	27	-DB (1)
GND	3	28	-DB (2)
GND	4	29	-DB (3)
GND	5	30	-DB (4)
GND	6	31	-DB (5)
GND	7	32	-DB (6)
GND	8	33	-DB (7)
GND	9	34	-DB (P)
GND	10	35	GND
GND	11	36	GND
Reserved	12	37	Reserved
(Open)	13	38	TERMPWR
Reserved	14	39	Reserved
GND	15	40	GND
GND	16	41	-ATN
GND	17	42	GND
GND	18	43	-BSY
GND	19	44	-ACK
GND	20	45	-RST
GND	21	46	-MSG
GND	22	47	-SEL
GND	23	48	-C/ D
GND	24	49	-REQ
GND	25	50	-I/ O

Note:

Reserved pins are connected to GND.

Figure 4.1 Pin assignment

4.2 SCSI Bus

4.2.1 System configuration

(1) System configuration

The SCSI bus connects up to eight SCSI devices, each linked with a daisy chain. The both ends of the daisy chain require a terminator.

Each SCSI device operates as an initiator or a target, so that a series of operations are performed between a pair of initiator and target pair.

The system may be configured with any combination of initiators and targets as long as the number of the initiators and targets combined does not exceed eight.

(2) Addresses of SCSI devices

Every SCSI device on the bus is assigned a unique address (SCSI ID) that corresponds to the data bus bit number. ID#7 through ID#0 correspond to DB7 through DB0. The SCSI ID provides identification for specifying particular SCSI device when an initiator selects a target or when a target reconnects an initiator.















SCSI ID also represents the priority for using the bus in the arbitration phase. (A description regarding the bus phase is given later.) Priorities are given in the descending order of data bus bit numbers (DBn), with the highest priority placed on ID#7 (DB7) and the lowest priority on ID#0 (DB0).

(3) Peripheral equipment

With the basic specification, an initiator can designate up to eight peripheral devices (logical units) belonging to a single target, where the peripheral devices are used as the I/O units of the initiator. Logical units are identified and selected by specifying their LUNs (logical unit numbers) in the IDENTIFY message or command (CDB: command descriptor block).

This scanner is equipped with a target and a logical unit, and its LUN is 000.

4.2.2 Bus signals

Signal name		Type of signal	Initiator  Target 
Data	DB0 DB1 DB2 DB3 DB4 DB5 DB6 DB7 (Data Bus n) DBP (Data Bus Parity)	<p>Eight data-bit signals, plus a parity-bit signal that form a DATA BUS. DB(7) is the most significant bit and has the highest priority during the ARBITRATION phase. Bit number, significance, and priority decrease downward to DB(0).</p> <p>A data bit is defined as one when the signal value is true. A data bit is defined as zero when the signal value is false. Data parity DB(P) shall be odd. Parity is undefined during the ARBITRATION phase.</p>	 
Control signals	BSY (Busy)	An “ORtied” signal that indicates that the bus is being used	 
	SEL (Select)	An “ORtied” signal used either by an initiator to select a target or by a target to reselect an initiator	 
	RST (Reset)	An “ORtied” signal that indicates the RESET condition	 
	C/ D (Control/Data) I/ O (Input/Output) MSG (Message)	The C/D, I/O, and MSG signals are used to distinguish between the different information transfer phases.	
	REQ (Request)	During an information transfer phase, the target uses this signal to request the initiator to transfer data	
	ACK (Acknowledge)	A signal driven by an initiator to indicate an acknowledgement for REQ/ACK data transfer handshake	
	ATN (Attention)	A signal driven by an initiator to indicate the ATTENTION condition	

4.2.3 Bus signal drive conditions

SCSI devices drive signals of the SCSI bus. The types of SCSI devices are summarized in the following table, showing the signals that they can drive for each operating phase of the interface.

There are two kinds of signal driving methods, OR tied and NON-OR tied, as shown in Table 4.2. During an interface operating sequence, the BSY signal could be driven simultaneously by two or more SCSI units when the data bus is in the ARBITRATION or RESELECTION phase. This situation also occurs with the RST signal (Reset). These two signals must be ORtied. For the other signals, either of the two methods may be used; further more, different drive methods may coexist for a signal on the bus.

Table 4.2 Bus phases vs. signal drive sources (1/2)

Signal Bus phase	BSY	SEL	I/O	C/D MSG	REQ	ACK	DB7 to 0 DBP	ATN	RST
BUS FREE	N	N	N	N	N	N	N	N	A
ARBITRATION	A	W	N	N	N	N	ID	N	A
SELECTION	I&T	I	N	N	N	I	I	I	A
RESELECTION	I&T	T	T	T	T	I	T	I	A
COMMAND	T	N	T	T	T	I	I	I	A
DATA IN	T	N	T	T	T	I	T	I	A
DATA OUT	T	N	T	T	T	I	I	I	A
STATUS	T	N	T	T	T	I	T	I	A
MESSAGE IN	T	N	T	T	T	I	T	I	A
MESSAGE OUT	T	N	T	T	T	I	I	I	A

N: The signal shall be released, since it is not being driven by any SCSI device.

A: The signal shall be driven by all SCSI devices that are actively arbitrating.

I: If driven, this signal shall be driven only the active initiator.

T: If the signal is driven, it shall be driven only by the active target.

W: The signal shall be driven by the one SCSI device that wins arbitration.

Table 4.2 Bus phases vs. signal drive sources (2/2)

- ID:** A unique data bit (the SCSI ID) shall be driven by each SCSI device that is actively arbitrating. The other seven data bits shall be released (shall not driven) by this SCSI device. The parity bit (DB(P)) may be released or driven to the true state, but shall never be driven to the false state during this phase.
- I&T:** The initiator and target drive the signal according to the interface operating sequence. The RESELECTION phase includes a sequence in which the initiator and target simultaneously drive the signal.

The signal shall be driven by the initiator, target, or both, as specified in the SELECTION phase and RESELECTION phase.

Table 4.3 Method of driving the interface signal

	OR connection	NON-OR connection
False	No signal is driven by any SCSI device. Signal status is made false by the termination resistor circuits.	The signal is driven false by a certain SCSI device (initiator or target), or is not driven by any SCSI device.
True	A SCSI device drives the signal true.	

4.3 Bus Phases

The SCSI architecture includes the following eight distinct phases:

- BUS FREE phase
 - ARBITRATION phase
 - SELECTION phase
 - RESELECTION phase
 - COMMAND phase
 - DATA phase
 - STATUS phase
 - MESSAGE phase
- } INFORMATION TRANSFER phase

The SCSI bus can never be in more than one phase at any given time.

The following diagram shows how each phase transits to another.

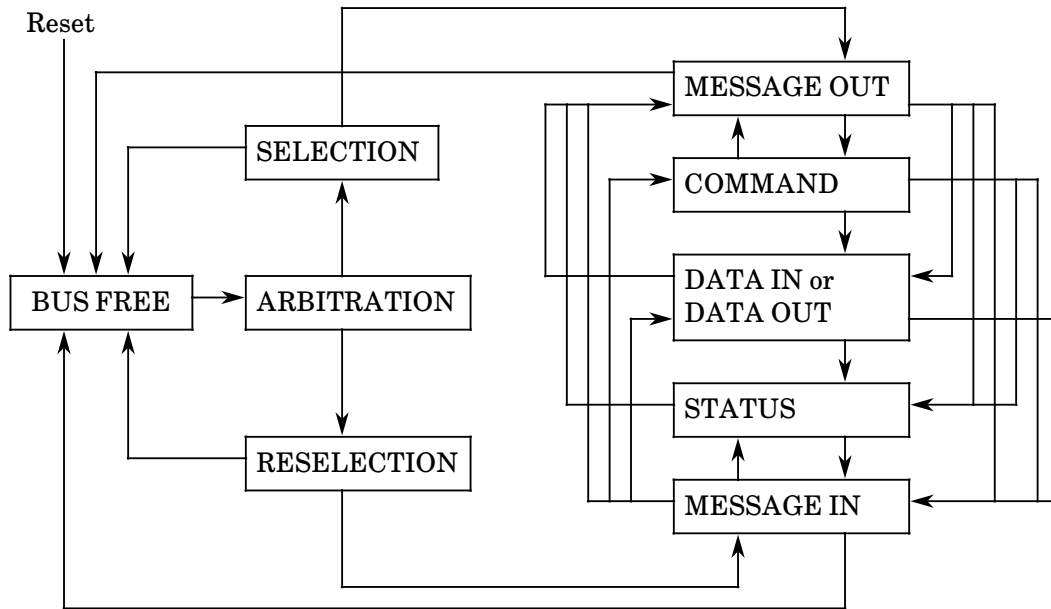

Figure 4.2 Phase sequence

The signal delay times for each bus phase are defined as follows:

Table 4.4 Signal delay times definition (1/3)

No.	Item	Time	Definition
1	Arbitration delay	2.4 μ s	The minimum time an SCSI device shall wait from asserting BSY for arbitration until the DATA BUS can be examined to see if arbitration has been won. There is no maximum time.
2	Assertion period	90 ns	The minimum time that a target shall assert REQ (or REQB) while using synchronous data transfers. Also, the minimum time that an initiator shall assert ACK while using synchronous data transfers.
3	Bus Clear delay	800 ns	<p>The maximum time for an SCSI device to stop driving all bus signals after:</p> <ol style="list-style-type: none"> (1) The BUS FREE phase is detected (BSY and SEL both false for a bus settle delay) (2) SEL is received from another SCSI device during the ARBITRATION phase (3) The transition of RST to true. <p>For the first condition listed, the maximum time for an SCSI device to clear the bus is 1200 nanoseconds from BSY and SEL first becoming both false. If an SCSI device requires more than a bus settle delay to detect BUS FREE phase, it shall clear the bus within a bus clear delay minus the excess time.</p>

Table 4.4 Signal delay times definition (2/3)

No.	Item	Time	Definition
4	Bus free delay	800 ns	The minimum time that an SCSI device shall wait from its detection of the BUS FREE phase (BSY and SEL both false for a bus settle delay) until its assertion of BSY when going to the ARBITRATION phase
5	Bus set delay	1.8 μ s	The maximum time for an SCSI device to assert BSY and its SCSI ID bit on the DATA BUS after it detects BUS FREE phase (BSY and SEL both false for a bus settle delay) for the purpose of entering the ARBITRATION phase
6	Bus settle delay	400 ns	The minimum time to wait for the bus to settle after changing certain control signals as called out in the protocol definitions
7	Cable skew delay	10 ns	The maximum difference in propagation time allowed between any two SCSI bus signals measured between any two SCSI devices
8	Data release delay	400 ns	The maximum time for an initiator to release the DATA BUS signals following the transition of the I/O signal from false to true
9	Deskew delay	45 ns	The minimum time required for deskew of certain signals
10	Disconnection delay	200 μ s	The minimum time that a target shall wait after releasing BSY before participating in an ARBITRATION phase when honoring a DISCONNECT message from the initiator
11	Hold time	45 ns	The minimum time added between the assertion of REQ (or REQ _B) or ACK (or ACK _B) and the changing of the data lines to provide hold time in the initiator or target while using synchronous data transfers. REQ _B and ACK _B timings only apply to optional wide data transfers.
12	Negation period	90 ns	The minimum time that a target shall negate REQ (or REQ _B) while using synchronous data transfers. Also, the minimum time that an initiator shall negate ACK (or ACK _B) while using synchronous data transfers. REQ _B and ACK _B timings only apply to optional wide data transfers.
13	Power-on to selection time	10 sec (recommended)	The recommended maximum time from power application until an SCSI target is able to respond with appropriate status and sense data to the TEST UNIT READY, INQUIRY, and REQUEST SENSE commands

Table 4.4 Signal delay times definition (3/3)

No.	Item	Time	Definition
14	Reset to selection time	250 ms (recommended)	The recommended maximum time after a hard RESET condition until an SCSI target is able to respond with appropriate status and sense data to the TEST UNIT READY, INQUIRY, and REQUEST SENSE commands
15	Reset hold time	25 μ s	The minimum time over which RST must be kept asserted
16	Selection abort time	200 μ s	The maximum time required from the moment when selection or deselection of an initiator or target is detected until BSY is asserted
17	Selection timeout delay	250 ms (recommended)	The minimum time required for an initiator or target in the selection or deselection phase to wait for a BSY response before it starts the timeout procedure
18	Transfer period		The minimum allowable period, during sync data transfer, between the start of consecutive REQ pulses and the start of consecutive ACK pulses

4.3.1 BUS FREE phase

The BUS FREE phase is used to indicate that no SCSI device is actively using the SCSI bus, and that it is available.

SCSI devices shall detect the BUS FREE phase after the SEL and BSY signals are both false for at least a bus settle delay.

SCSI devices shall release all SCSI bus signals within a bus clear delay after the BSY and SEL signals become continuously false for a bus settle delay.

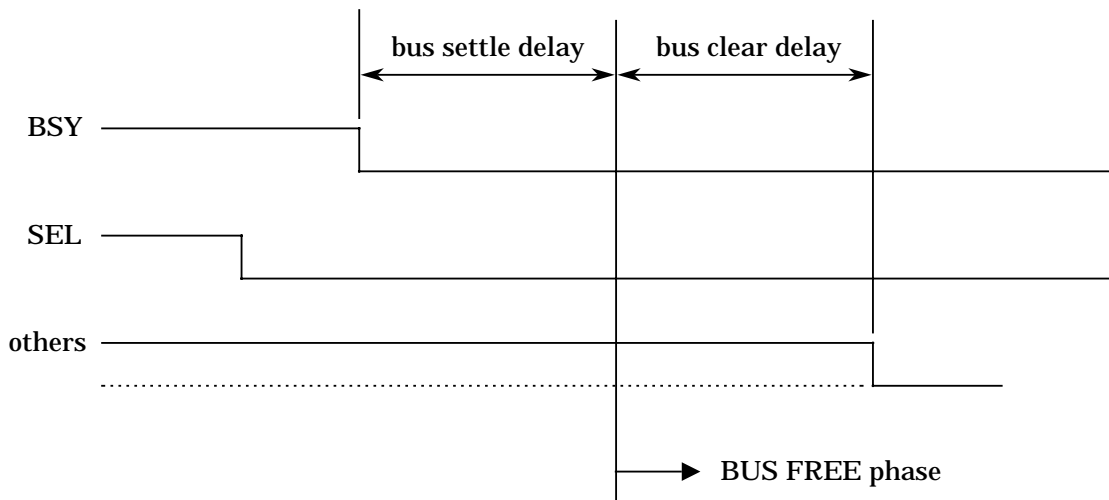

4.3.2 ARBITRATION phase

The ARBITRATION phase allows one SCSI device to gain control of the SCSI bus so that it can initiate or resume an I/O process. The procedure for an SCSI device to obtain control of the SCSI bus is as follows:

- ① The SCSI device shall first wait for the BUS FREE phase to occur.
- ② The SCSI device shall wait a minimum of a bus free delay after detection of the BUS FREE phase (i.e. after the BSY and SEL signals are both false for a bus settle delay) before driving any signal.
- ③ Following the bus free delay in Step ②, the SCSI device may arbitrate for the SCSI bus by asserting both the BSY signal and its own SCSI ID, however, the SCSI device shall not arbitrate (i.e. assert the BSY signal and its SCSI ID) if more than a bus set delay has passed since the BUS FREE phase was last observed.
- ④ After waiting at least an arbitration delay (measured from its assertion) the SCSI device shall examine the DATA BUS. If a higher priority SCSI ID bit is true on the DATA BUS (DB(7) is the highest), then the SCSI device has lost the arbitration and the SCSI device may release its signals and return to Step ①. If no higher priority SCSI ID bit is true on the DATA BUS, then the SCSI device has won the arbitration and it shall assert the SEL signal. Any SCSI device other than the winner has lost the arbitration and shall release the BSY signal and its SCSI ID bit within a bus clear delay after the SEL signal becomes true. An SCSI device that loses arbitration may return to Step ①.
- ⑤ The SCSI device that wins arbitration shall wait at least a bus clear delay plus a bus settle delay after asserting the SEL signal before changing any signals.

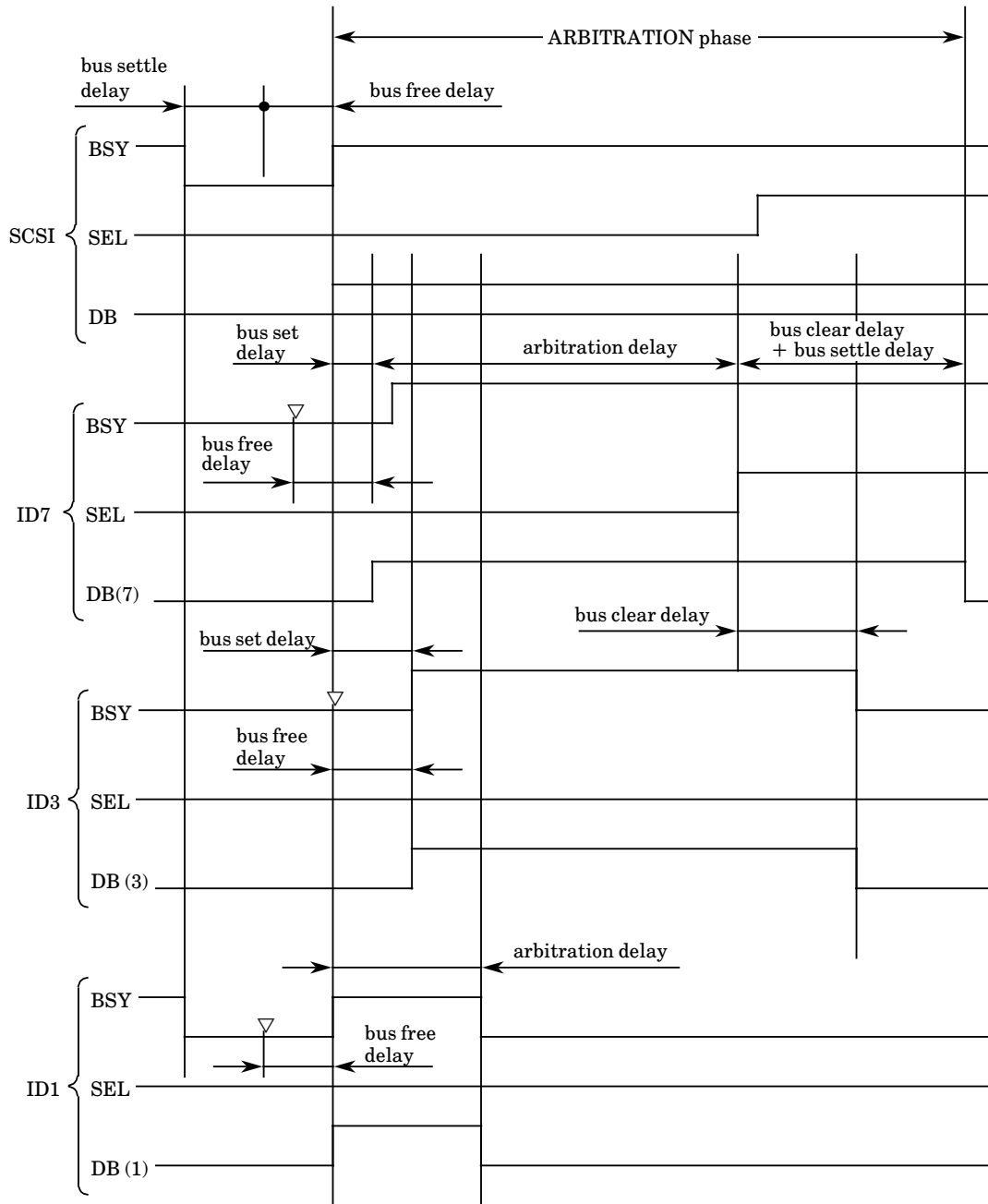

ID7: Succeeds in ARBITRATION

ID3: Detects the SEL signal of other SCSI unit

ID1: Detects the SCSI ID with higher priority than itself

▽: The point at which the BUS FREE phase is detected by each SCSI unit.

4.3.3 SELECTION phase

The SELECTION phase allows an initiator to select a target for the purpose of initiating some target function (e.g., READ or WRITE command). During the SELECTION phase the I/O signal is negated so that this phase can be distinguished from the RESELECTION phase.

- ① The SCSI device that won the arbitration has both the BSY and SEL signals asserted and has delayed at least a bus clear delay plus a bus settle delay before ending the ARBITRATION phase. The SCSI device that won the arbitration becomes an initiator by not asserting the I/O signal.
- ② The initiator shall set the DATA BUS to a value which is the OR of its SCSI ID bit and the target's SCSI ID bit, and it shall assert the ATN signal.
- ③ The initiator shall then wait at least two deskew delays and release the BSY signal.
- ④ The initiator shall then wait at least a bus settle delay before looking for a response from the target.
- ⑤ The target shall determine that it is selected when the SEL signal and its SCSI ID bit are true and the BSY and I/O signals are false for at least a bus settle delay. The selected target may examine the DATA BUS in order to determine the SCSI ID of the selecting initiator. The selected target shall then assert the BSY signal within a selection abort time of its most recent detection of being selected; this assertion is required for correct operation of the selection time-out procedure.

The target shall not respond to a selection if bad parity is detected. Also, if more than two SCSI ID bits are on the DATA BUS, the target shall not respond to selection.

- ⑥ No less than two deskew delays after the initiator detects the BSY signal is true, it shall release the SEL signal and may change the DATA BUS. The target shall wait until the SEL signal is false before asserting the REQ signal to enter an information transfer phase.

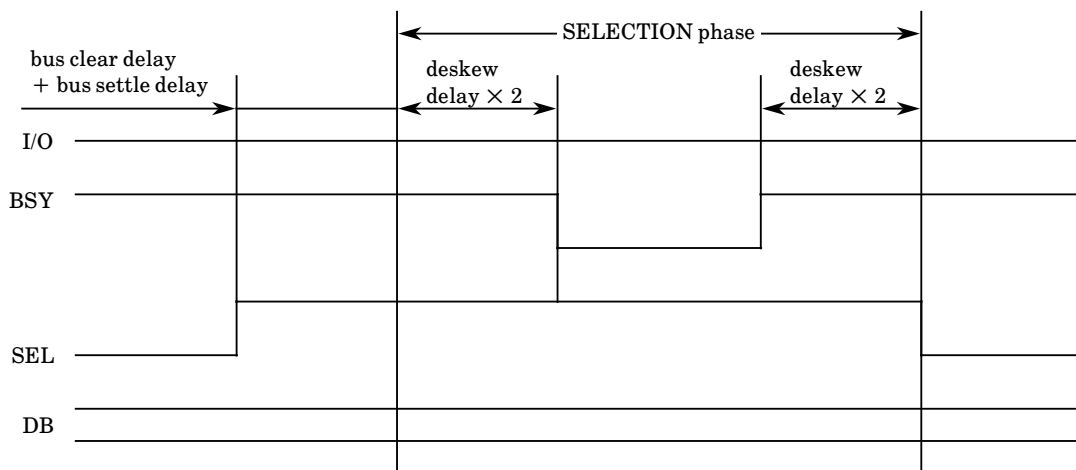

4.3.4 RESELECTION phase

RESELECTION is an optional phase that allows a target to reconnect to an initiator for the purpose of continuing some operation that was previously started by the initiator but was suspended by the target (i.e., the target disconnected by allowing a BUS FREE phase to occur before the operation was complete).

- ① Upon completing the ARBITRATION phase, the winning SCSI device has both the BSY and SEL signals asserted and has delayd at least a bus clear delay plus a bus settle delay. The winning SCSI device becomes a target by asserting the I/O signal.
- ② The winning SCSI device shall also set the DATA BUS to a value that is the logical OR of its SCSI ID bit and the initiator's SCSI ID bit.
- ③ The target shall wait at least two deskew delays and release the BSY signal.
- ④ The target shall then wait at least a bus settle delay before looking for a response from the initiator.
- ⑤ The initiator shall determine that it is reselected when the SEL and I/O signals and its SCSI ID bit are true and the BSY signal is false for at least a bus settle delay. The reselected initiator may examine the DATA BUS in order to determine the SCSI ID of the reselecting target. The reselected initiator shall then assert the BSY signal within a selection abort time of its most recent detection of being reselected; this is required for correct operation of the time-out procedure. The initiator shall not respond to a RESELECTION phase if bad parity is detected. Also, the initiator shall not respond to a RESELECTION phase if other than two SCSI ID bits are on the DATA BUS.
- ⑥ After the target detects the BSY signal is true, it shall also assert the BSY signal and wait at least two deskew delays and then release the SEL signal. The target may then change the I/O signal and the DATA BUS. After the reselected initiator detects the SEL signal is false, it shall release the BSY signal. The target shall continue asserting the BSY signal until it relinquishes the SCSI bus.

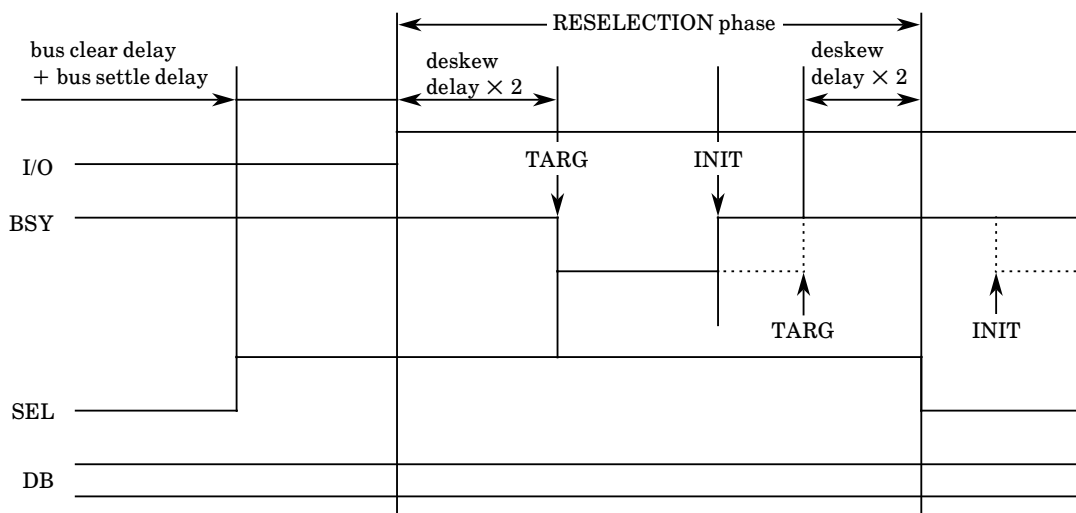

4.3.5 INFORMATION TRANSFER phases

Note:

The COMMAND, DATA, STATUS, and MESSAGE phases are all grouped together as the information transfer phases because they are all used to transfer data or control information via the DATA BUS. The actual content of the information is beyond the scope of this section.

The C/D, I/O, and MSG signals are used to distinguish between the different information transfer phases (see Table 4.5). The target drives these three signals and therefore controls all changes from one phase to another. The initiator can request a MESSAGE OUT phase by asserting the ATN signal, while the target can cause the BUS FREE phase by releasing the MSG, C/D, I/O, and BSY signals.

Table 4.5 INFORMATION TRANSFER phase type

Phase	C/D	I/O	MSG	DB7 to 0, P	Transfer direction
DATA OUT	0	0	0	Data	INIT ⇒ TARG
DATA IN	0	1	0	Data	INIT ⇐ TARG
COMMAND	1	0	0	Command	INIT ⇒ TARG
STATUS	1	1	0	Status	INIT ⇐ TARG
*	0	0	1		
*	0	1	1		
MESSAGE OUT	1	0	1	Message	INIT ⇒ TARG
MESSAGE IN	1	1	1	Message	INIT ⇐ TARG

* : Reserved for future standardization

0: False
1 True
INIT: Initiator
TARG: Target

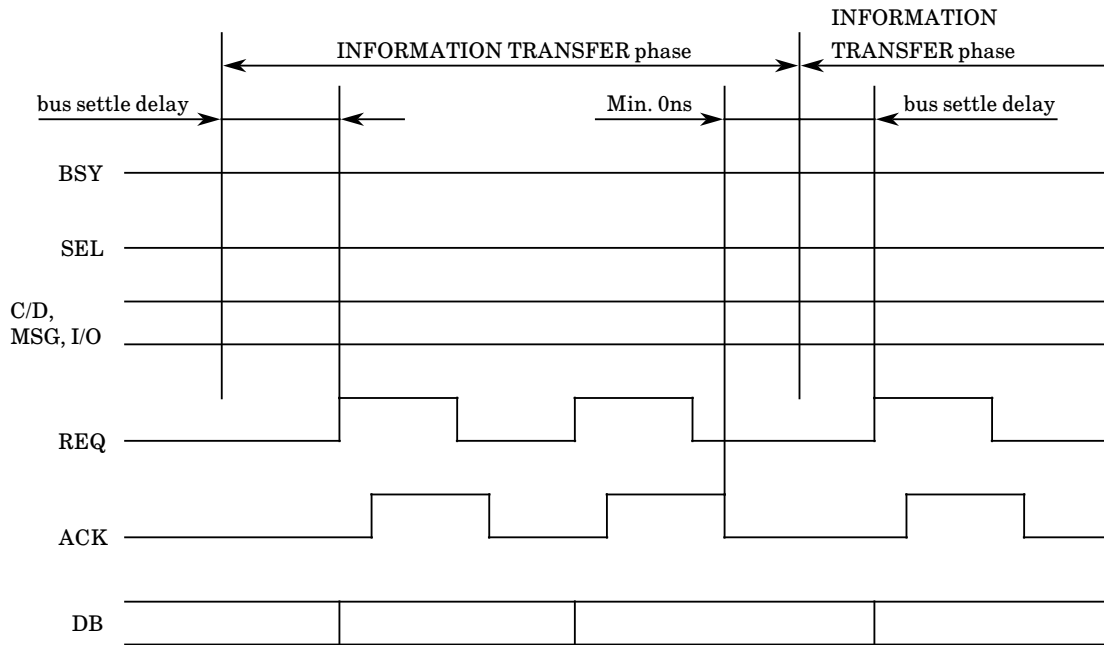

The INFORMATION TRANSFER phases use one or more REQ/ACK handshakes to control the information transfer. Each REQ/ACK handshake allows the transfer of one byte of information. During the INFORMATION TRANSFER phases the BSY signal shall remain true and the SEL signal shall remain false. Additionally, during the INFORMATION TRANSFER phases, the target shall continuously envelope the REQ/ACK handshake (s) with the C/D, I/O, and MSG signals in such a manner that these control signals are valid for a bus settle delay before the assertion of the REQ signal of the first handshake. These control signals remain valid until after the negation of the ACK signal at the end of the handshake of the last transfer of the phase.

(1) Asynchronous information transfer

The target shall control the direction of information transfer by means of the I/O signal. When the I/O signal is true, information shall be transferred from the target to the initiator. When the I/O signal is false, information shall be transferred from the initiator to the target.

a. Asynchronous transfer from target to initiator

If the I/O signal is true (transfer to the initiator), the target shall first drive the DB(7-0, P) signals to their desired values, delay at least one deskew delay plus a cable skew delay then assert the REQ signal. The DB(7-0, P) signals shall remain valid until the ACK signal is true at the target. The initiator shall read the DB(7-0, P) signals after the REQ signal is true then indicate its acceptance of the data by asserting the ACK signal. When the ACK signal becomes true at the target, the target may change or release the DB(7-0, P) signals and shall negate the REQ signal. After the REQ signal is false, the initiator shall then negate the ACK signal.

After the ACK signal is false, the target may continue the transfer by driving the DB(7-0, P) signals and asserting the REQ signal, as previously described.

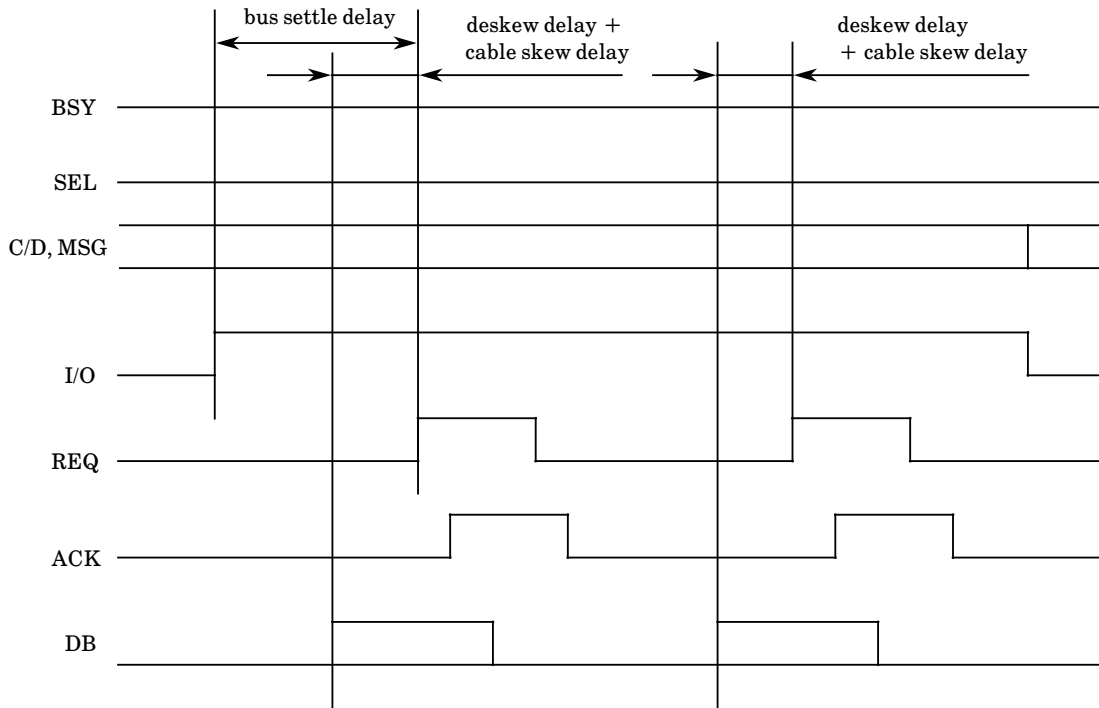

b. Asynchronous transfer from initiator to target

If the I/O signal is false (transfer to the target), the target shall request information by asserting the REQ signal. The initiator shall drive the DB(7-0, P) signals to their desired values, delay at least one deskew delay plus a cable skew delay then assert the ACK signal. The initiator shall continue to drive the DB(7-0, P) signals until the REQ signal is false. When the ACK signal becomes true at the target, the target shall read the DB(7-0, P) signals then negate the REQ signal. When the REQ signal becomes false at the initiator, the initiator may change or release the DB(7-0, P) signals and shall negate the ACK signal. The target may continue the transfer by asserting the REQ signal, as previously described.

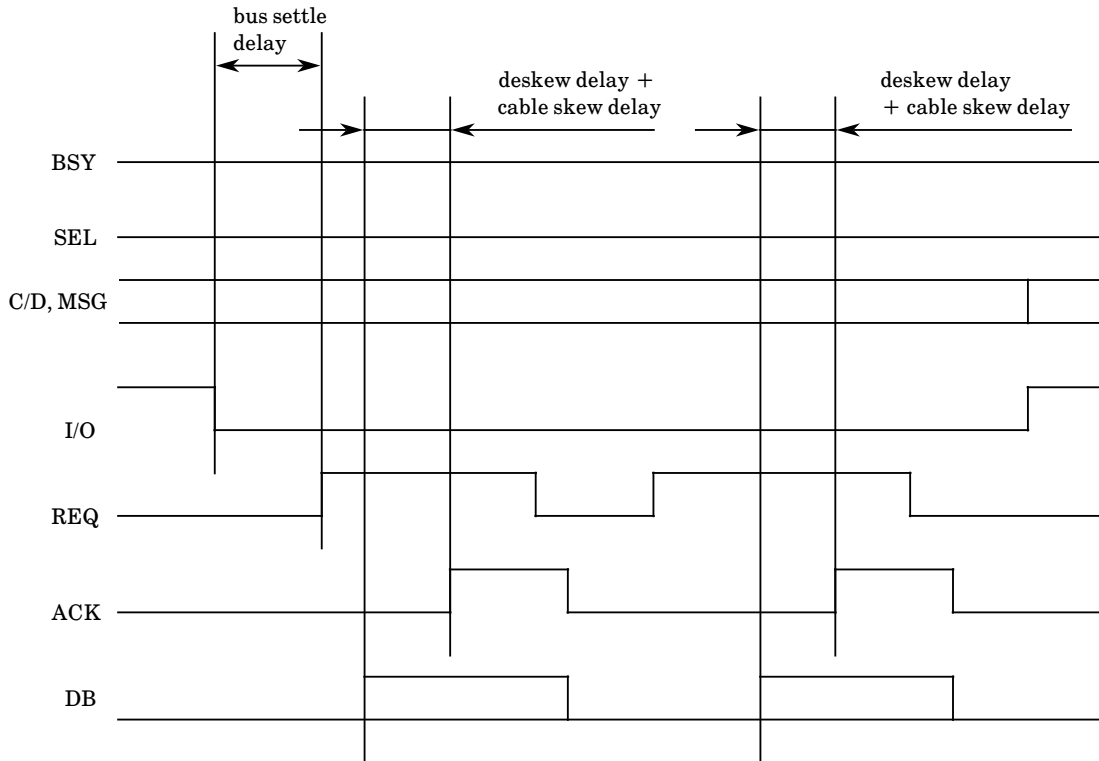

4.4 Commands

Commands are directions issued from an initiator to a target. This image scanner supports the following range of the commands specified by the SCSI standard.

- (a) The identification number of logical unit (LUN: logical unit number) is B'000'.

If this scanner receives a value other than 000, it returns error information as follows:

- Status key: B'00001' (CHECK CONDITION)
- Sense key: X'5' (ILLEGAL REQUEST)

- (b) Relative addressing is not supported.

If this scanner receives a relative address (RelAdr) = 1, it returns error information as follows:

- Status key: B'00001' (CHECK CONDITION)
- Sense key: X'5' (ILLEGAL REQUEST)

- (c) A control byte is not supported.

If this scanner receives a control byte \neq X'00', it returns error information as follows:

- Status key: B'00001' (CHECK CONDITION)
- Sense key: X'5' (ILLEGAL REQUEST)

(d) A bit and field described as “Reserved” are 0.

If this scanner receives a value other than 0, it returns error information as follows:

- Status key: B‘00001’ (CHECK CONDITION)
- Sense key: X‘5’ (ILLEGAL REQUEST)

The commands supported by this scanner are listed below.

Table 4.6 Commands

Command	Operation code (hex)	Description
RESERVE UNIT	16	Declares the exclusive use of a logical unit
RELEASE UNIT	17	Cancels the declaration of the exclusive use of a logical unit
INQUIRY	12	Examines the information regarding the target and logical unit
REQUEST SENSE	03	Requests a target for sense data
SEND DIAGNOSTIC	1D	Requests a target for self-check
TEST UNIT READY	00	Checks whether or not a logical unit is ready
SET WINDOW	24	Sets a window
SET SUBWINDOW	C0	Sets subwindows
SEND	2A	Sends Dither Matrix
OBJECT POSITION	31	Controls the automatic document feeder
READ	28	Requests transfer of image data
MODE SELECT	15	Selects operating mode of the device.
MODE SENSE	1A	Requests operating mode of the device.

4.4.1 RESERVE UNIT command

The following table shows the normal sequence of the RESERVE UNIT command when used with this scanner.

Step	Bus phase	Initiator operation	← →	Target operation
1	BUS FREE	Verifies bus free		
2	ARBITRATION	Obtains bus-usage right		
3	SELECTION	Selects target	→	
				Drives BSY signal
4	MESSAGE OUT	Selects logical unit	→	
5	COMMAND	Specifies RESERVE UNIT (CDB)	→	
6	STATUS		←	Reports GOOD status
7	MESSAGE IN		←	Reports message (Command Complete)
				Releases BSY signal
8	BUS FREE			

(1) RESERVE UNIT command: COMMAND phase (initiator → target)

Where a logical unit can be accessed by two or more initiators, there could be interferences with command sequences, data, etc. This situation can be avoided by issuing the RESERVE UNIT command before initiating a series of operations.

Once a logical unit has properly accepted the RESERVE UNIT command, it will be occupied by the initiator that issued the RESERVE UNIT command. If the 3rd party reservation option is supported, the logical unit might be occupied by another SCSI unit — one having an initiator function — which is specified TPID. In this condition, called “reserved,” the logical unit cannot be accessed from any other initiators. The reserved condition remains effective until one of the following events take place:

- ① The reservation is replaced by a new RESERVE COMMAND from the same initiator that has reserved the logical unit. (Issuing another RESERVE UNIT command with the reservation still effective does not results in an error. The previously established reservation is released as a result of ②, ③ or ④ described below.)
- ② The RELEASE UNIT command is issued from the same initiator that has reserved the logical unit.

- ③ The BUS DEVICE RESET message is sent from any initiator.
- ④ A hardware reset condition is detected.

The condition in effect after ③ or ④ is indicated by a sense key X'6' (UNIT ATTENTION), which is returned in response to a subsequent command.

When a logical unit is already reserved by another initiator, if a command other than RELEASE UNIT, INQUIRY, or REQUEST SENSE is issued, the target returns the following status:

- Status: B'01100' (RESERVATION CONFLICT)

The initiator having reserved a logical unit can change the reservation by issuing the RESERVE UNIT command to the same logical unit.

The command descriptor block (CDB) of this command is shown in the following illustration.

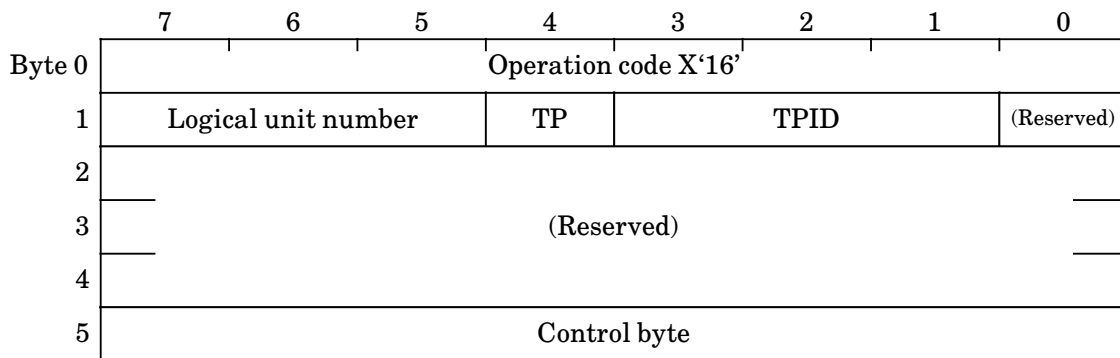

- a. TP (third party) : Byte 1

As this scanner does not support the 3rd party reservation option, setting this bit to 1 causes the target to return the following error information:

- Status: B'00001' (CHECK CONDITION)
- Sense key: X'5' (ILLEGAL REQUEST)

- b. TPID (third party device ID) : Byte 1

This scanner ignores TPID.

4.4.2 RELEASE UNIT command

The following table shows the normal sequence of the RESERVE UNIT command when used with this scanner.

Step	Bus phase	Initiator operation	← →	Target operation
1	BUS FREE	Verifies bus free		
2	ARBITRATION	Obtains bus-usage right		
3	SELECTION	Selects target	→	
				Drives BSY signal
4	MESSAGE OUT	Selects logical unit	→	
5	COMMAND	Specifies RELEASE UNIT (CDB)	→	
6	STATUS		←	Reports GOOD status
7	MESSAGE IN		←	Reports message (Command Complete)
				Releases BSY signal
8	BUS FREE			

- (1) RELEASE UNIT command: COMMAND phase (initiator → target)

The RELEASE UNIT command releases a reserved status. If this command comes from an initiator that has not declared reservation, the target ignores the command and responds with the GOOD status (the reserved status is not released).

The CDB of this command is shown in the following illustration.

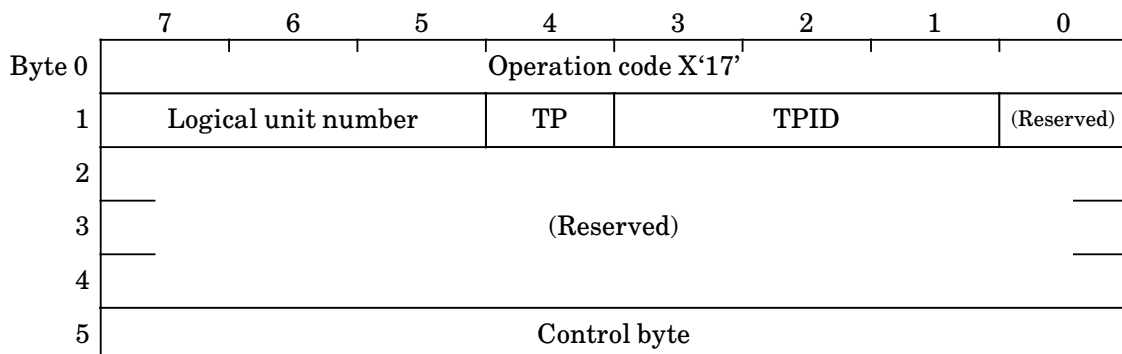

a. TP (third party) : Byte 1

As this scanner does not support the 3rd party reservation option, setting this bit to 1 causes the target to return the following error information:

- Status: B'00001' (CHECK CONDITION)
- Sense key: X'5' (ILLEGAL REQUEST)

b. TPID (third party device ID) : Byte 1

This scanner ignores TPID.

4.4.3 INQUIRY command

The following table shows the normal sequence of the INQUIRY command when used with this scanner.

Step	Bus phase	Initiator operation	← →	Target operation
1	BUS FREE	Verifies bus free		
2	ARBITRATION	Obtains bus-usage right		
3	SELECTION	Selects target	→	
				Drives BSY signal
4	MESSAGE OUT	Selects logical unit	→	
5	COMMAND	Specifies INQUIRY (CDB)	→	
6	DATA IN		←	Reports inquiry data
7	STATUS		←	Reports GOOD status
8	MESSAGE IN		←	Reports message (Command Complete)
				Releases BSY signal
9	BUS FREE			

(1) INQUIRY command: COMMAND phase (initiator → target)

The INQUIRY command used to check information regarding a target and logical unit.

The CDB of this command is shown in the following illustration.

	7	6	5	4	3	2	1	0
Byte 0	Operation code X'12'							
1	Logical unit number			(Reserved)			EVPD	
2	Page code							
3	(Reserved)							
4	Allocation length							
5	Control byte							

a. EVPD (enable vital product data) : Byte 1

This scanner does not support EVPD. If this bit is set to 1, the scanner returns the following error information:

- Status: B'00001' (CHECK CONDITION)
- Sense key: X'5' (ILLEGAL REQUEST)

b. Page code: Byte 2

This scanner does not support page code. If this bit is set to 1, the scanner returns the following error information:

- Status: B'00001' (CHECK CONDITION)
- Sense key: X'5' (ILLEGAL REQUEST)

c. Allocation length: Byte 4

This field specifies the storage area in bytes that the initiator allocates for inquiry data. If a 0 is set here, inquiry data is not transferred, but this is not regarded as an error. The target terminates the DATA IN phase when it has transferred either the bytes of inquiry data specified in this field or all of effective inquiry data.

(2) Inquiry data: DATA IN pahse (target → initiator)

	7	6	5	4	3	2	1	0
Byte 0	Peripheral qualifier			Peripheral device type				
1	RMB	Device type qualifier						
2	ISO version		ECMA version		ANSI approved version			
3	AENC	(Reserved)		Response data format				
4	Additional length (n-4)							
5	(Reserved)							
6	(Reserved)							
7	RelAdr	Wbus32	Wbus16	SYNC	LINKED	CACHE	CMDQUE	SftRst
8	(MSB)							
	Vendor identification							
F	(LSB)							
10	(MSB)							
{	Product identification							
1F	(LSB)							
20	(MSB)							
{	Product revision level							
23	(LSB)							
24	(Reserved)							
{	(Reserved)							
5F	(Reserved)							

a. Peripheral qualifier: Byte 0

Indicates the connection status of the devices under control of the target. This scanner returns B'000'.

b. Peripheral device type: Byte 0

Indicates the type of the devices under control of the target. This scanner returns B'00110' (scanner).

- c. Removable medium (RMB) : Byte 1
This scanner does not support RMB. This scanner returns B'0'.
- d. Device type qualifier: Byte 1
This scanner does not support this field. This scanner always returns B'0000000'.
- e. ISO version, ECMA version, ANSI approved version: Byte 2
Indicates the version number of the governing standard. This scanner returns X'02' (SCSI-2).
- f. Asynchronous event notification capability (AENC) : Byte 3
This scanner does not support this field, so it returns B'0'.
- g. Response data format: Byte 3
Indicates the standard, and its version number, that governs the format of inquiry data. This scanner returns B'0010' (SCSI-2).
- h. Additional length (n-4) : Byte 4
Specifies the number of bytes, from byte 5 to the last byte. This value will not change with the allocation length value specified in CDB. This scanner returns X'5B' (the 91 bytes from byte 5 to byte 5F).
- i. RelAdr, Wbus32, Wbus16: Byte 7
This scanner does not support RelAdr/ Wbus32/ Wbus16. This scanner returns B'000'.
- j. SYNC (synchronous transfer) : Byte 7
This scanner returns B'0' ("synchronous transfer not supported").
- k. Linked, cache, CMDQUE: Byte 7
This scanner does not support linked/cache/CMDQUE. This scanner returns B'000'.
- l. sftRst (Soft Reset) : Byte 7
This scanner performs Hardware Reset. This scanner returns B'0'.
- m. Vendor identification: Bytes 8 to F
Indicates the vendor of the logical unit in ASCII code. The vendor name is left-justified, with the blank filled with spaces (X'20'). This scanner returns "FUJITSU".

n. Product identification: Bytes 10 to 1F

Indicates the product name in ASCII code. The name is left-justified, with the blank filled with spaces (X'20'). This scanner returns one of the following names:

M3097G without option
M3097Gi with image processing II option
M3097Gm with CMPII option
M3097Gim with image processing II option and CMP II option

o. Product revision level: Bytes 20 to 23

Indicates the version number of the product in ASCII code. This number is left-justified, with the blank filled with spaces (X'20').

4.4.4 REQUEST SENSE command

The following table shows the normal sequence of the REQUEST SENSE command when used with this scanner.

Step	Bus phase	Initiator operation	← →	Target operation
1	BUS FREE	Verifies bus free		
2	ARBITRATION	Obtains bus-usage right		
3	SELECTION	Selects target	→	
				Drives BSY signal
4	MESSAGE OUT	Selects logical unit	→	
5	COMMAND	Specifies REQUEST SENSE (CDB)	→	
6	DATA IN		←	Reports sense data
7	STATUS		←	Reports GOOD status
8	MESSAGE IN		←	Reports message (Command Complete)
				Releases BSY signal
9	BUS FREE			

- (1) REQUEST SENSE command: COMMAND phase (initiator → target)

The REQUEST SENSE command requests the sense data that shows the status of a logical unit. On receiving this command, the target sets the unit's status in the sense data and returns it to the initiator.

The CDB of this command is shown in the following illustration.

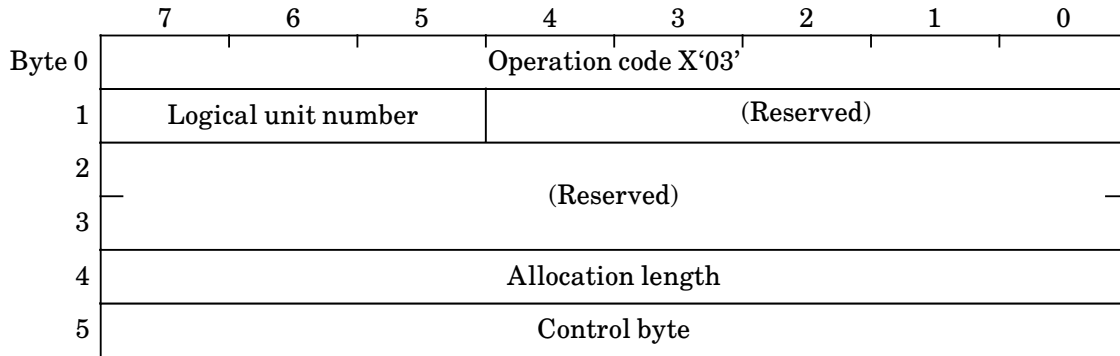

- a. Allocation length: Byte 4

Specifies the storage area in bytes that the initiator allocates for sense data. If a 0 is set here, sense data is not transferred, but this is not treated as an error. The target terminates the DATA IN phase when it has transferred either the bytes of sense data specified in this field or all of effective sense data.

- (2) Sense data: DATA IN phase (target → initiator)

The target creates sense data if its status is B'00001' (CHECK CONDITION) or if a BUS FREE error has occurred. This scanner creates sense data when any of the errors described later is encountered.

The sense data on this scanner is shown in the following illustration.

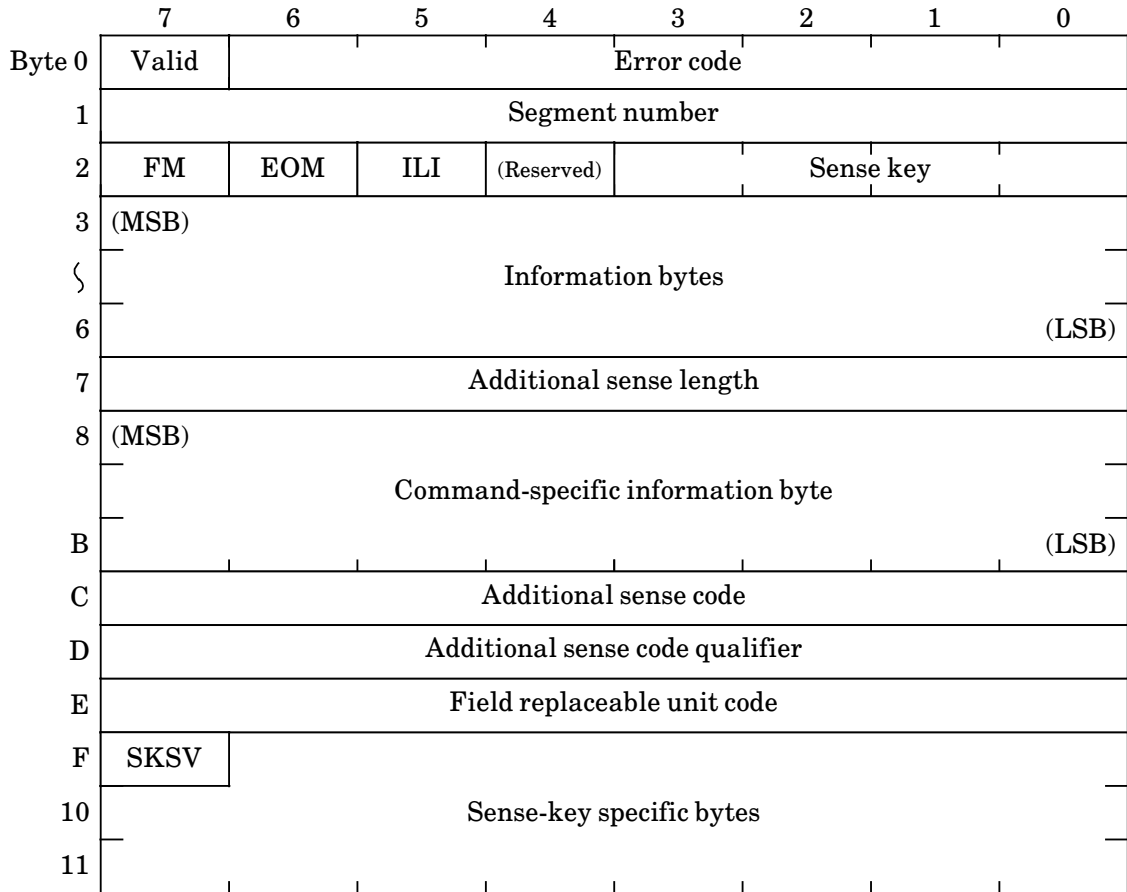

a. Valid: Byte 0

Indicates whether or not the INFORMATION BYTES field is as specified by ANSI. This scanner returns B'1' ("specified by ANSI").

b. Error code: Byte 0

Differentiates between current error or deferred error. This scanner returns X'70' ("CURRENT ERROR").

c. Segment number: Byte 1

This scanner does not support SEGMENT NUMBER. This scanner returns X'00'.

d. FM (file mark): Byte 2

This scanner does not support FM. This scanner returns B'0'.

e. EOM (end of medium): Byte 2

Indicates the completion of window reading: 1 when completed, 0 when not completed

- f. ILI (incorrect length indicator): Byte 2

Indicates that an error in logical block length has been detected

- g. Sense key: Byte 2

Indicates the logical unit status using a sense key. This scanner supports the sense keys shown in the following table:

Sense key	Status of logical unit
0	NO SENSE The logical unit has no information to be specifically described in a sense key. This status occurs because either a command has succeeded, or because a command has terminated in the CHECK CONDITION status since the ILI bit has been set to 1.
2	NOT READY The specified logical unit cannot be accessed.
3	MEIDUM ERROR A command has terminated because of a trouble with the medium. Typical causes of this error with this scanner are that the ADF paper chute is empty, paper is jammed in the ADF, or the ADF cover has been opened.
4	HARDWARE ERROR An unrecoverable error was detected.
5	ILLEGAL REQUEST An illegal parameter exists either in a command (CDB), or in a group of parameters sent in the DATA OUT phase following a command.
6	UNIT ATTENTION The target has been reset.
B	ABORTED COMMAND The target has aborted a command.

- h. Information bytes: Bytes 3 to 6

The information in this field is effective if ILI is 1. This scanner returns the remainder (2's complement for any negative value) so the requested transfer amount subtracted by the actual transfer amount.

- i. Additional sense length: Byte 7

Specifies the number of sense bytes that follows. Even if all additional sense bytes cannot be transferred because the allocation length in CDB is small, the value in this field is not adjusted to indicate the remaining data. This scanner always assumes X'0A'.

- j. Command-specific information bytes: Bytes 8 to B

On this scanner, this field is not supported and is fixed to X'00000000'.

- k. Additional sense code, additional sense code qualifier: Bytes C and D

A combination of these fields specifies detailed information about the error reported in the sense key. This scanner reports the following information:

Sense key	Additional sense code	Additional sense code qualifier	Description
0	00	00	No- sense
2	00	00	Not ready
2	80	01	Interlock switch is opened
3	80	01	Jam
3	80	02	ADF cover open
3	80	03	Document chuter empty of paper
3	80	04	Detects job separation sheet (See Appendix A.5)
4	80	01	Blown fuse for FB motor
4	80	02	Blown fuse for heater
4	80	03	Blown lamp fuse
4	80	04	Blown fuse for ADF motor
4	80	05	Mechanical alarm
4	80	06	Optical alarm
4	44	00	Abnormal internal target
4	47	00	SCSI parity error
5	20	00	Invalid command
5	24	00	Invalid field in CDB
5	25	00	Unsupported logical unit
5	26	00	Invalid field in parameter list
5	2C	02	Wrong window combination
6	00	00	UNIT ATTENTION
B	43	00	Message error
B	80	01	Image transfer error

1. Sense-key specific bytes: Bytes F to 11

This field is reserved on this scanner.

(X'00000000' must not be expected.)

4.4.5 SEND DIAGNOSTIC command

The following table shows the normal sequence of the SEND DIAGNOSTIC command when used with this scanner.

Step	Bus phase	Initiator operation	← →	Target operation
1	BUS FREE	Verifies bus free		
2	ARBITRATION	Obtains bus-usage right		
3	SELECTION	Selects target	→	
				Drives BSY signal
4	MESSAGE OUT	Selects logical unit	→	
5	COMMAND	Specifies SEND DIAGNOSTIC (CDB)	→	Performs self-test
6	STATUS		←	Reports GOOD status
7	MESSAGE IN		←	Reports message (Command Complete)
				Releases BSY signal
8	BUS FREE			

- (1) SEND DIAGNOSTIC command: COMMAND phase (initiator → target)

The SEND DIAGNOSTIC command is used by an initiator to request a target or logical unit for self-test. Two types of self-diagnostic are: (a) the self-test performed by the unit itself, and (b) the test conducted according to the instruction data from the initiator.

This scanner supports the self-test only.

The results of self-test are reported using the status and sense data.

The CDB of this command is shown in the following illustration.

	7	6	5	4	3	2	1	0
Byte 0	Operation code X'1D'							
1	Logical unit number			PF	(Reserved)	SLFTST	D0	U0
2	(Reserved)							
3	(MSB) Parameter list length (LSB)							
4								
5	Control byte							

- a. PF (page format): Byte 1

This scanner ignores PF.

- b. SLFTST (self test): Byte 1

This value is 1 on this scanner.

- c. DO (device offline), UO (unit offline): Byte 1

This scanner ignores DO and UO.

- d. Parameter list length: Bytes 3 to 4

This scanner does not support parameter list length.

(2) Contents of self-test

The contents of self-test shall be an equivalent of NOP (Non Operation), provided that CHECK CONDITION is reported if error information is withheld in the unit.

(3) Response

This scanner reports as follows:

- a. Normal

The GOOD status is returned.

- Status: B'00000' (GOOD)
- Sense key: X'0' (NO SENSE)

- b. Abnormal

If error information is being withheld, the following status is returned:

- Status: B'00001' (CHECK CONDITION)
- Sense key: Error information being withheld

4.4.6 TEST UNIT READY command

The following table shows the normal sequence of the TEST UNIT READY command when used with this scanner.

Step	Bus phase	Initiator operation	← →	Target operation
1	BUS FREE	Verifies bus free		
2	ARBITRATION	Obtains bus-usage right		
3	SELECTION	Selects target	→	
				Drives BSY signal
4	MESSAGE OUT	Selects logical unit	→	
5	COMMAND	Specifies TEST UNIT READY (CDB)	→	
6	STATUS		←	Reports GOOD status
7	MESSAGE IN		←	Reports message (Command Complete)
				Releases BSY signal
8	BUS FREE			

- (1) TEST UNIT READY command: COMMAND phase (initiator → target)

The TEST UNIT READY command checks whether a logical unit is ready. This command does not request self-test. The acknowledgment of this command reported using the status and sense data.

The CDB of this command is shown in the following illustration.

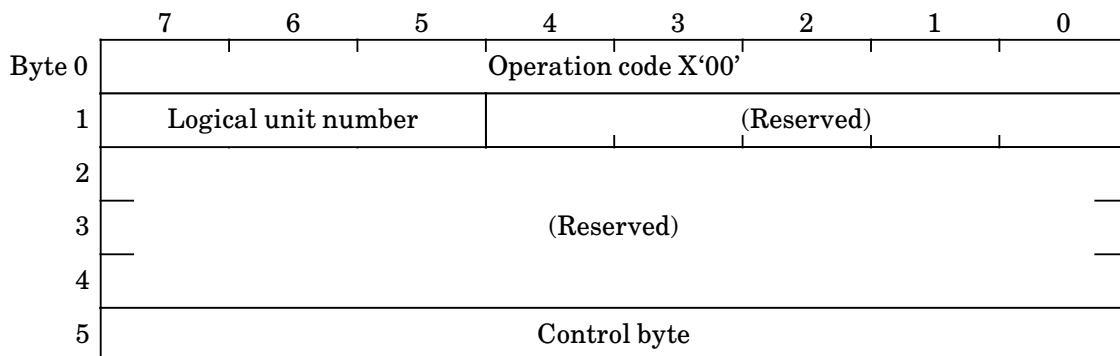

(2) Response

This scanner reports as follows:

a. Normal:

- Status: B'00000' (GOOD)
- Sense key: X'0' (NO SENSE)

b. Abnormal:

- Status: B'00001' (CHECK CONDITION)
- Sense key: X'0', X'2', X'3', X'4', X'5', X'6', or X'B'

4.4.7 SET WINDOW command

The following table shows the normal sequence of the SET WINDOW command when used with this scanner.

Step	Bus phase	Initiator operation	↔	Target operation
1	BUS FREE	Verifies bus free		
2	ARBITRATION	Obtains bus-usage right		
3	SELECTION	Selects target	→	
				Drives BSY signal
4	(MESSAGE OUT)	Selects logical unit	→	
5	COMMAND	Specifies SET WINDOW (CDB)	→	Sets window
6	DATA OUT	Specifies window data	→	
7	STATUS		←	Reports GOOD status
8	MESSAGE IN		←	Reports message (Command Complete)
				Releases BSY signal
9	BUS FREE			

(1) SET WINDOW command: COMMAND phase (initiator → target)

The SET WINDOW command is used to set a window.

The CDB of this command is shown in the following illustration.

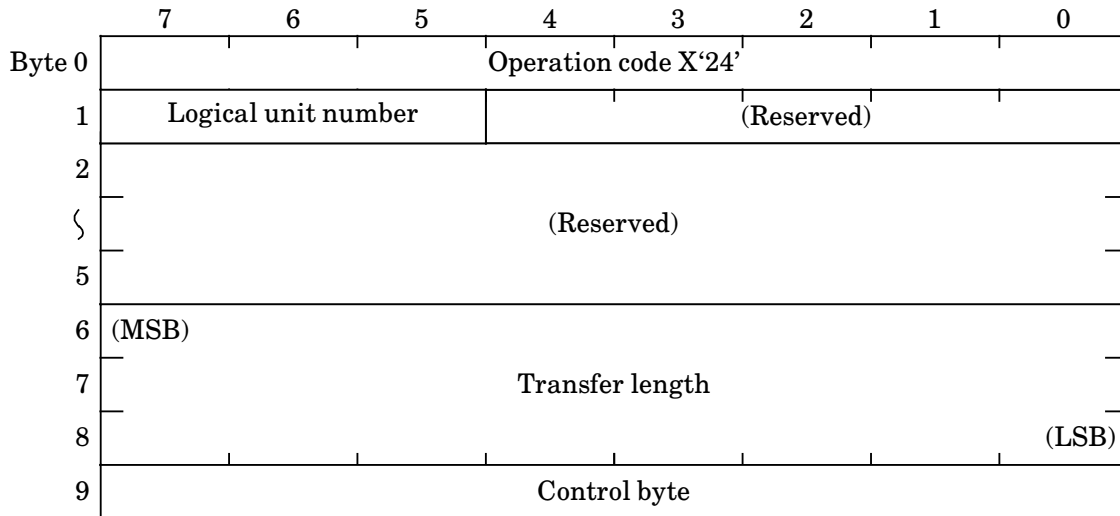

a. TRANSFER LENGTH: Bytes 6 to 8

Specifies the number of window data bytes sent in the DATA OUT phase.

A zero (0) means that no data is to be transferred; this situation is not considered an error.

If the number of bytes is not enough (less than 48) to set a window, the scanner returns the following error information:

- Status: B'00001' (CHECK CONDITION)
- Sense key: X'5' (ILLEGAL REQUEST)

(2) Window data: DATA OUT phase (initiator → target)

Window data specifies the details of a window. Window data contains a head and one or more window descriptor block. Each window descriptor block specifies the attributes of a window (size, position, scan mode, etc.).

If a target receives the SET WINDOW command when it already has window data, the target discards all of the current window data and validates the newly received data.

a. Header

Window data (header) is shown in the following illustration.

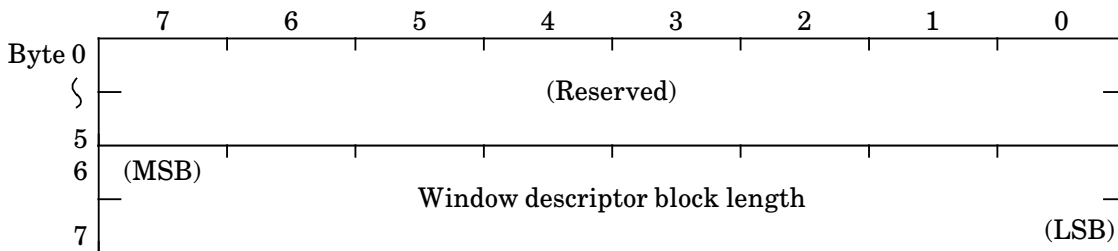

(a) Window descriptor block length: Bytes 6 and 7

Specifies the length in bytes of a window descriptor block. Each block has the same length. The allowable range of length is between 40 and 248 bytes. For a length outside this range, this scanner returns the following error information:

- Status: B'00001' (CHECK CONDITION)
- Sense key: X'5' (ILLEGAL REQUEST)

b. Window descriptor block

Window parameter data (window descriptor block) is shown in the following illustration.

(a) Window identifier: Byte 0

Specifies a unique value that identifies a window. The value may be 0 to 255. If two or more window identifiers are specified for a single set of window data, the most recently specified identifier is validated.

This scanner allows only one window to be set. Therefore, only 0 may be specified in this field. If a value other than 0 is specified, this scanner returns the following error information:

- Status: B'00001' (CHECK CONDITION)
- Sense key: X'5' (ILLEGAL REQUEST)

(b) Auto: Byte 1

This scanner does not support Auto. If a value other than 0 is specified, this scanner returns the following error information:

- Status: B'00001' (CHECK CONDITION)
- Sense key: X'5' (ILLEGAL REQUEST)

(c) X, Y resolution (XR, YR) : Bytes 2 to 3 and 4 to 5

Specified here are the resolutions in the horizontal (X) and vertical (Y) scanning directions, in pixels per inch. If 0 is specified, the default value (400 dpi) is assumed.

If the image processing option is not equipped, the acceptable resolution value is limited to 0, 400, 300, 240 or 200. If the option is equipped, the acceptable value is in the range from 50 to 1600 dpi in steps of 1 dpi. If a value is specified that does not comply with these conditions, this scanner returns the following error information:

- Status: B'00001' (CHECK CONDITION)
- Sense key: X'5' (ILLEGAL REQUEST)

(d) Upper left X, Y (ULX, ULY) : Bytes 6 to 9, A to D

Specified here are the X and Y coordinates of the upper-left corner of the window. The coordinates are expressed in units of 1/1200 inches relative to the upper-left corner of the maximum scan area.

If the ULX or ULY value is outside the maximum scan area of this scanner, this scanner returns the following error information:

- Status: B'00001' (CHECK CONDITION)
- Sense key: X'5' (ILLEGAL REQUEST)

(e) Width, length (W, L) : Bytes E to 11, 12 to 15

Specifies here are the width and length of the window, in units of 1/1200 inches. If the W or L value is outside the maximum scan area of this scanner, the following error information is returned:

- Status: B'00001' (CHECK CONDITION)
- Sense key: X'5' (ILLEGAL REQUEST)

The same error is also returned if this scanner is set to less than one raster line for vertical scanning or to less than two bytes for horizontal scanning.

Notes:

1. ULX, ULY, W, L versus maximum scan area:

$$0 < (ULX + W) \leq 14592 \text{ (in 1/1200 inches)}$$

$$0 < (ULY + L) \leq 20736 \text{ (in 1/1200 inches)}$$

2. Conditions for horizontal scanning:

$$9 \leq [XR \times W/1200] \leq 4864 \text{ (dot)}$$

(Values under 0 in [] are omitted.)

3. Conditions for vertical scanning:

$$1 \leq [YR \times L/1200] \leq 6912 \text{ (line)}$$

(Values under 0 in [] are omitted.)

4. Conditions for horizontal and vertical scanning (in 1/1200 inches):

$$13200 \text{ (11") } < (ULX + W) \leq 14592$$

When this condition is satisfied, following condition must also be satisfied (only for CMPII option equipped).

$$0 < (ULY + L) \leq 19842 \text{ (A3 length)}$$

(f) Brightness: Byte 16

Specifies the brightness for halftone (Byte 19 = X'01') output.

Value (Hex)	Brightness
00	Default: same as value X'80'.
01 ↕ 80 ↕ FF	Brightest Normal Darkest

(g) Threshold: Byte 17

Specifies the threshold value for the line art (Byte 19 = X'00').

Value (Hex)	Threshold
00	Default: <ul style="list-style-type: none">• without IPCII option<ul style="list-style-type: none">- Same as value X'80'.• with IPCII option<ul style="list-style-type: none">- Dynamic threshold, or simplified dynamic threshold
01 ↕ 80 ↕ FF	Brightest Normal Darker

(h) Contrast: Byte 18

Specifies the contrast value for the line art or the halftone.

Value (Hex)	Contrast
00	Default: same as value X'80'.
01 ↕ 80 ↕ FF	Mostly soft Normal Mostly sharp

(i) IMAGE COMPOSITION: Byte 19

Value (Hex)	Image output
00	Line art (Binary image)
01	Halftone (Binary image)
02	Gray scale
03 to FF	(Reserved)

If reserved value is specified, this scanner returns the following error information as follows:

- Status: B'00001' (CHECK CONDITION)
- Sense key: X'5' (ILLEGAL REQUEST)

(j) Bit per pixel: Byte 1A

Specifies the number of bits per pixel.

This scanner supports X'01', and reserves X'00' and X'02' to X'FF'.

If reserved value is specified, this scanner returns the following error information as follows:

- Status: B'00001' (CHECK CONDITION)
- Sense key: X'5' (ILLEGAL REQUEST)

(k) Halftone type: Byte 1B

Value (Hex)	Halftone method
00	Default This scanner applies dither.
01	Dither
02	Error diffusion
03 to FF	(Reserved)

If reserved value is specified, this scanner returns the following error information as follows:

- Status: B'00001' (CHECK CONDITION)
- Sense key: X'5' (ILLEGAL REQUEST)

(k) Halftone Pattern: Byte 1C

Value (Hex)	Halftone pattern
00	Dither pattern 0
01	Dither pattern 1
02	Dither pattern 2
03	Dither pattern 3
04 to 7F	(Reserved)
80 to 84	User down-load pattern
85 to FF	(Reserved)

If reserved value is specified, this scanner returns the following error information as follows:

- Status: B'00001' (CHECK CONDITION)
- Sense key: X'5' (ILLEGAL REQUEST)

(l) RIF (reverse image format): Byte 1D, bit 7

This bit is used when the binary image data output is being reversed.

- 0: Output is not reversed
- 1: Output is reversed

If a 1 is specified for this scanner without the image processing II option, this scanner returns the following error information:

- Status: B'00001' (CHECK CONDITION)
- Sense key: X'5' (ILLEGAL REQUEST)

(m) Padding type: Byte 1D, bits 0 to 2

This scanner does not support Padding type. If a value other than B'000' is specified, this scanner returns following error information:

- Status: B'00001' (CHECK CONDITION)
- Sense key: X'5' (ILLEGAL REQUEST)

(n) Bit ordering: Bytes 1E to 1F

This scanner does not support bit ordering. If a value other than X'0000' is specified, this scanner returns the following error information:

- Status: B'00001' (CHECK CONDITION)
- Sense key: X'5' (ILLEGAL REQUEST)

(o) Compression type, argument: Bytes 20 to 21

Specifies the compression method that is applied before the read data is sent to the initiator

TYPE (Byte 20)	argument (Byte 21)
00 — Not compressed	Reserved
01 — MH	Reserved
02 — MR	K parameter
03 — MMR	Reserved

When the CMPII option is not connected, if a value other than the “Not compressed” is specified, this scanner returns the following error information:

- Status: B'00001' (CHECK CONDITION)
- Sense key: X'5' (ILLEGAL REQUEST)

(p) Vender unique parameter (byte 28 and after)

Specifies, in byte 28 and after, a vender unique parameter, including items such as subwindow list, outline, emphasis, automatic separation, mirroring, and paper size, as required. This parameter is specified in the following format. This parameter does not need data until byte 3F. (It is unnecessary to transfer the unnecessary parameter, but the intermediate parameter cannot be omitted.)

	7	6	5	4	3	2	1	0
28	Vender unique identification code							
29	pattern							
2A	Outline extraction							
2B	Image emphasis							
2C	Automatic separation							
2D	Mirror image							
2E	Variance rate							
2F	DTC mode							
30								
31	Not supported							
32	White level follower mode							
33	(MSB)	Subwindow list						(LSB)
34								
35	Paper size							
36	(MSB)	Paper width X						(LSB)
37								
38								
39								
3A	(MSB)	Paper length Y						(LSB)
3B								
3C								
3D								
3E	DTC selection							
3F	Reserved							

- Vender unique identification code: byte 28

Specifies a vender unique identification code. For this scanner, X'00' must be specified. If other value is specified, this scanner returns the following error information:

- Status: B'00001' (CHECK CONDITION)
- Sense key: X'5' (ILLEGAL REQUEST)

- γ pattern: Byte 29

Specifies the γ pattern number for the line art or the halftone.

Value (Hex)	γ pattern
00	Default This scanner applies "Normal".
01	Normal
02	Soft
03	Sharp
04 to 7F	(Reserved)
80 to 84	User down-load γ pattern
85 to FF	(Reserved)

If reserved value is specified, this scanner returns the following error information as follows:

- Status: B'00001' (CHECK CONDITION)
- Sense key: X'5' (ILLEGAL REQUEST)
- Outline extraction: Byte 2A

Value (Hex)	Meaning
00	Default This scanner not applies outline extraction.
01 to 7F	(Reserved)
80	Enable outline extraction. See note 1.
81 to FF	(Reserved)

If reserved value is specified, this scanner returns the following error information as follows:

- Status: B'00001' (CHECK CONDITION)
- Sense key: X'5' (ILLEGAL REQUEST)

Note 1: If image processing II option is not provided, this scanner will report as error.

- Image emphasis: Byte 2B

This scanner is limited to three levels of emphasis and one level of smoothing. These levels are specified as follows:

Value (Hex)	Meaning
00	Without emphasis and smoothing
01 to 2F	Low emphasis
30 to 4F	Medium emphasis
50 to 7F	High emphasis
80 to FF	Smoothing

When the image processing II option is not provided, and this parameter is specified, this scanner returns the following error information:

- Status: B'00001' (CHECK CONDITION)
- Sense key: X'5' (ILLEGAL REQUEST)
- Automatic separation: byte 2C

Specifies the automatic separation for the window. When the automatic separation is performed, X'80' is specified. When the automatic separation is not performed, X'00' is specified. When the image processing II option is not provided, and X'80' is specified, this scanner returns the following error information:

- Status: B'00001' (CHECK CONDITION)
- Sense key: X'5' (ILLEGAL REQUEST)
- Mirror image: byte 2D

Specifies the mirroring for the window. When the mirroring is performed, X'80' is specified. When the image processing option II is not provided and this parameter is specified, following error information is responded:

- Status: B'00001' (CHECK CONDITION)
- Sense key: X'5' (ILLEGAL REQUEST)

- Variance rate: byte 2E

Specifies variance rate for simplified dynamic threshold.

Value (Hex)	Variance rate
00	Default
01 to 1F	Small
20 to 3F	Small
40 to 5F	↑
60 to 7F	↓
80 to 9F	Normal
A0 to BF	↑
C0 to DF	↓
E0 to FF	Large

- DTC mode: byte 2F

X'A6' is set when the power is turned on.

This byte is valid when IPC II option is installed, and byte 3E is X'40'.

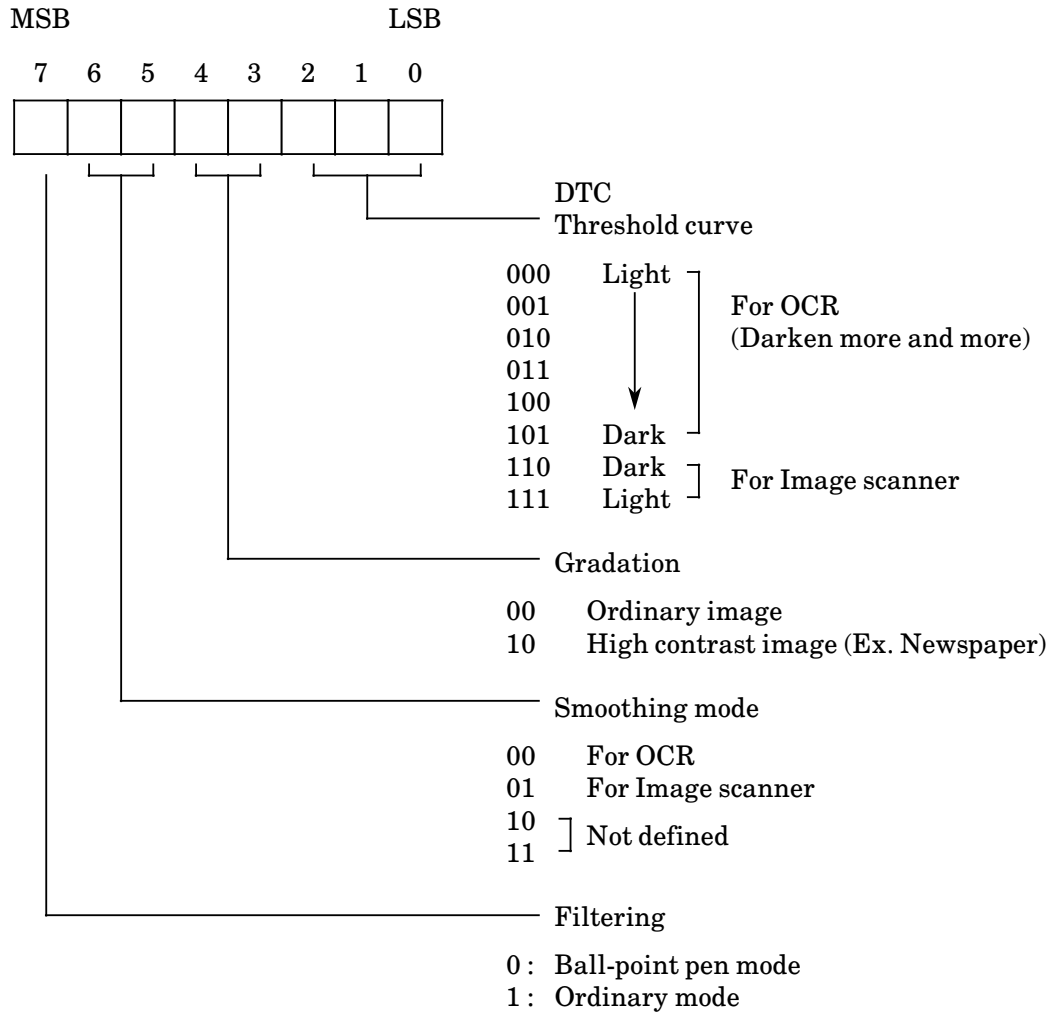

- DTC mode: byte 30

X'20' is set when the power is turned on.

This byte is valid when the IPC II is installed, and byte 3E is X'40'.

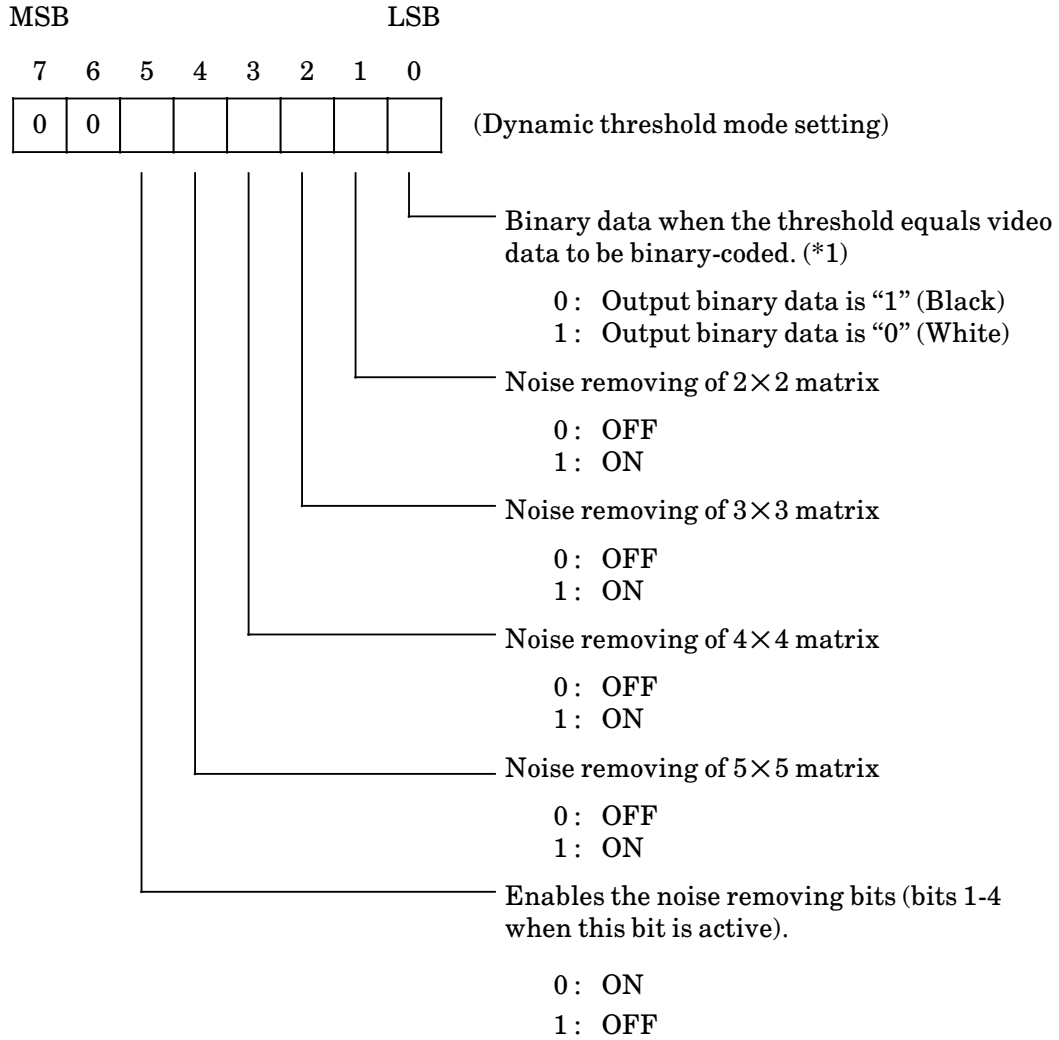

*1 When this bit is "0", the output video data is black if the gradation of the video data is equal to or larger than threshold. When this bit is "1", the output video data is white if the gradation of the video data is equal to or larger than threshold.

- White level follower: byte 32

Value (Hex)	Meaning						
00	Default. White level follower depends on the IMAGE COMPOSITION.						
	<table border="1"> <thead> <tr> <th>IMAGE COMPOSITION</th> <th>White level follower</th> </tr> </thead> <tbody> <tr> <td>Line art (X'00')</td> <td>Enables white level follower</td> </tr> <tr> <td>Halftone (X'01')</td> <td>Disable</td> </tr> </tbody> </table>	IMAGE COMPOSITION	White level follower	Line art (X'00')	Enables white level follower	Halftone (X'01')	Disable
	IMAGE COMPOSITION	White level follower					
	Line art (X'00')	Enables white level follower					
Halftone (X'01')	Disable						
Line art (X'00')	Enables white level follower						
Halftone (X'01')	Disable						
01 to 7F	(Reserved)						
80	Enables white level follower.						
81 to BF	(Reserved)						
C0	Disables white level follower.						
C1 to FF	(Reserved)						

If reserved value is specified, this scanner returns the following error information as follows:

- Status: B'00001' (CHECK CONDITION)
- Sense key: X'5' (ILLEGAL REQUEST)
- Subwindow list: bytes 33 and 34

Specifies the subwindow identifier for a subwindow included in the window according to the specification in bytes 33 and 34. (For example; X'0001' for subwindow 0, X'0002' for subwindow 1, X'0006' for subwindows 1 and 2.)

On this scanner, four subwindows can be included in one window. Thus, bits 0 to 3 of byte 34 can be specified. If other subwindows are specified, this scanner returns the following error information:

- Status: B'00001' (CHECK CONDITION)
- Sense key: X'5' (ILLEGAL REQUEST)
- Paper size: bytes 35

Specifies a paper size when the ADF is used. This parameter is valid when the ADF is used. When the flat-bid being used, this parameter is ignored.

When the ADF is used invalidate the paper size specification by specifying X'00' in this parameter.

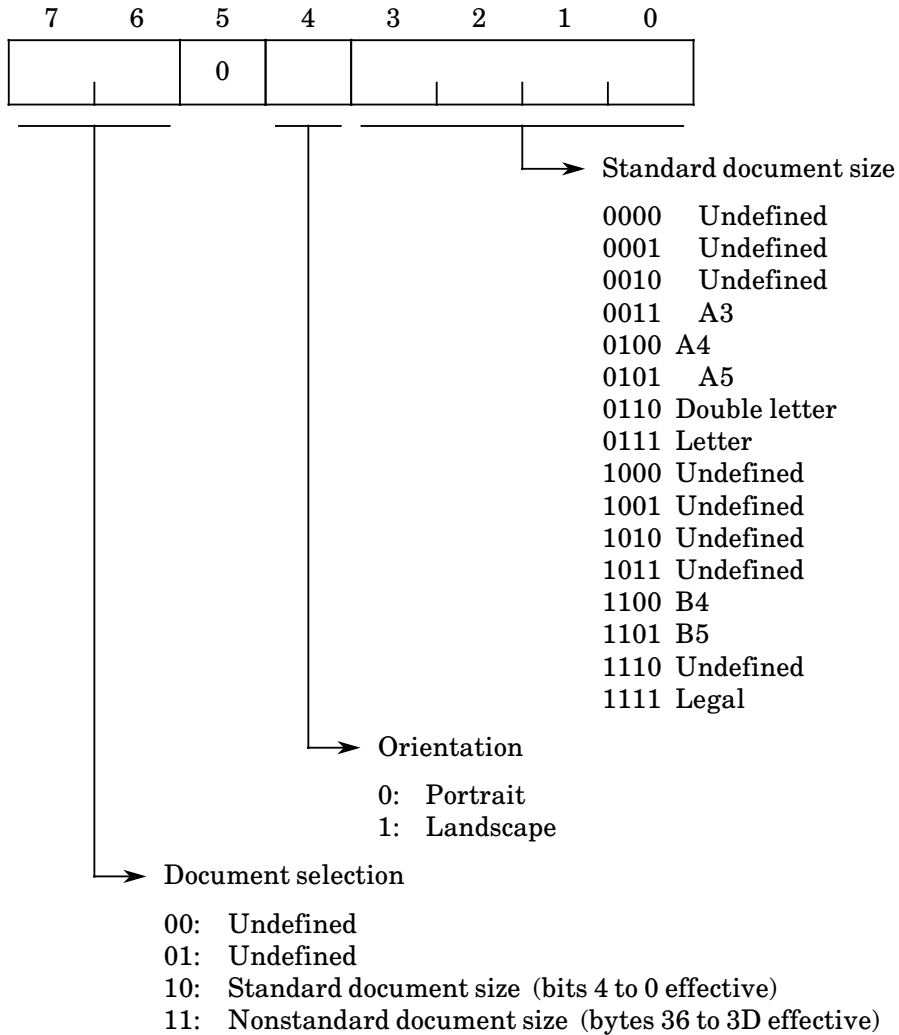

If undefined value is specified this scanner return the following error information:

- Status: B'00001' (CHECK CONDITION)
- Sense key: X'5' (ILLEGAL REQUEST)
- Paper width X, paper length Y: bytes 36 to 39, 3A to 3D

These parameters are valid when the nonstandard size is specified in the paper size parameter (byte 35).

The paper width and length is specified in 1/1200 inches unit.

Notes:

1. If the ADF is used and this parameter has not been specified, the paper is scanned on the default paper size (A3) of this scanner.
 2. The paper size specified here concerns the sheets loaded in the ADF. The area specified by the WINDOW bytes 6 to 15 in the window data should be equal to or smaller than the specified paper size.
 3. The ADF for this scanner positions paper relative to the center. Therefore, if paper size is not specified in the window data bytes 6 to 15, the window cannot be accurately positioned for the paper.
 4. This parameter is only effective for reading with the ADF.
- DTC SELECTION: byte 3E

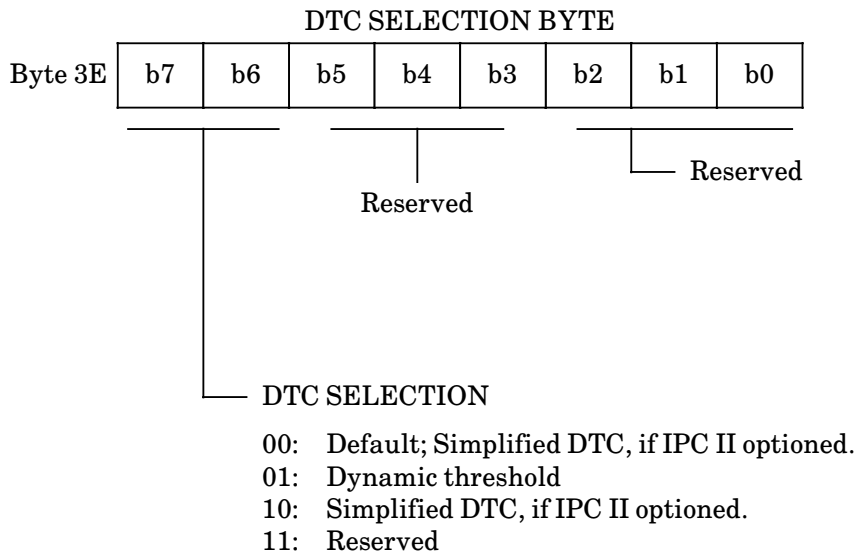

If reserved value is specified, this scanner returns the following error information as follows:

- Status: B'00001' (CHECK CONDITION)
- Sense key: X'5' (ILLEGAL REQUEST)

Note:

If simplified dynamic threshold is selected. (Byte 3E = X'00' or X'80'), variance rate (byte 2E) is valid.

If dynamic threshold is selected (byte 3E = X'40'), DTC mode (byte 2F and 30) are valid.

4.4.8 SET SUBWINDOW command

The following table shows the normal sequence of the SET SUBWINDOW command when used with this scanner.

Step	Bus phase	Initiator operation	↔	Target operation
1	BUS FREE	Verifies bus free		
2	ARBITRATION	Obtains bus-usage right		
3	SELECTION	Selects target	→	
				Drives BSY signal
4	MESSAGE OUT	Selects logical unit	→	
5	COMMAND	Specifies SET SUBWINDOW (CDB)	→	Sets subwindow
6	DATA OUT	Specifies subwindow data	→	
7	STATUS		←	Reports GOOD status
8	MESSAGE IN		←	Reports message (Command Complete)
				Releases BSY signal
9	BUS FREE			

(1) SET SUBWINDOW command: COMMAND phase (initiator → target)

The SET SUBWINDOW command is used to set subwindows. If this command is issued more than once, only the one issued directly before the READ command becomes effective.

The SET SUBWINDOW command only works if the image processing II option is equipped. If this command is received by a scanner without the image processing II option, this scanner returns the following error information:

- Status: B'00001' (CHECK CONDITION)
- Sense key: X'5' (ILLEGAL REQUEST)

The CDB of this command is shown in the following illustration.

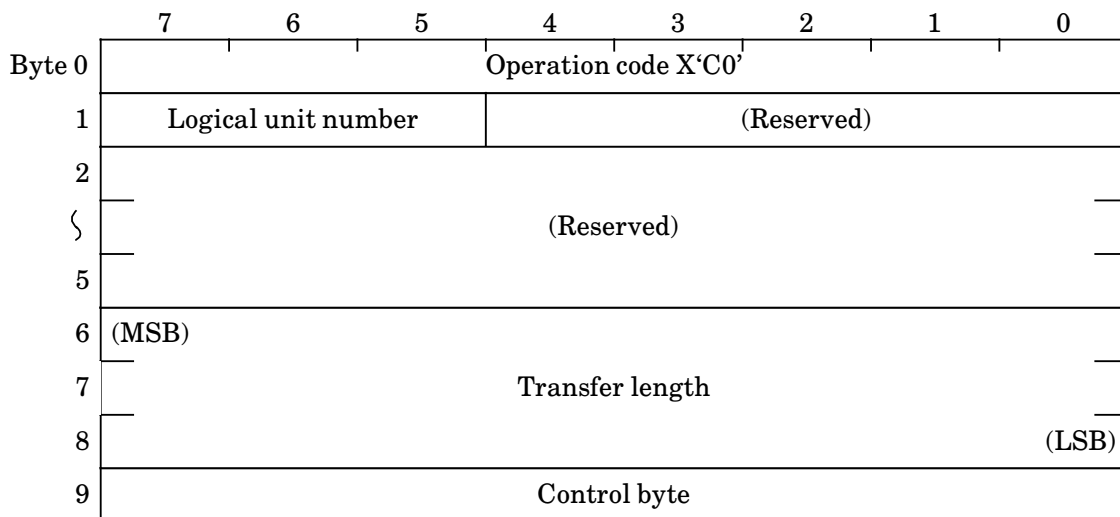

a. Transfer length: Bytes 6 to 8

Specifies the number of subwindow data bytes sent in the Data Out phase. A 0 means no data is to be transferred; it is not considered an error.

If the number of bytes is not enough to set a single subwindow, an error occurs.

(2) Subwindow data: DATA OUT phase (initiator → target)

Subwindow data specifies details of a subwindow.

Subwindow data contains one header and one or more subwindow descriptor blocks. Each subwindow descriptor block specifies the attributes of a subwindow (such as size, position, scan mode).

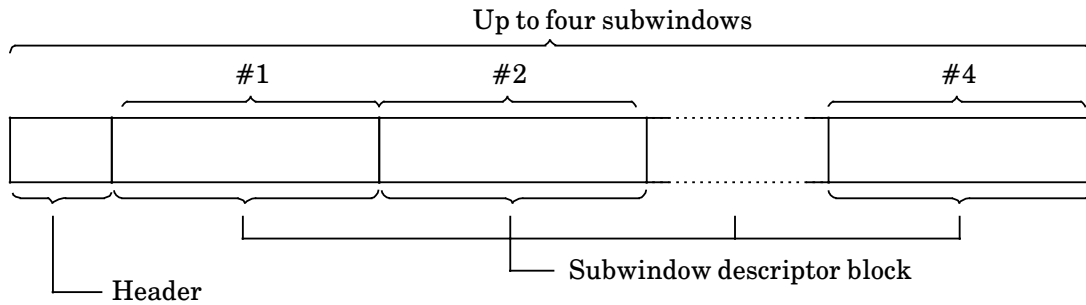

a. Header

Subwindow data (header) is shown in the following illustration.

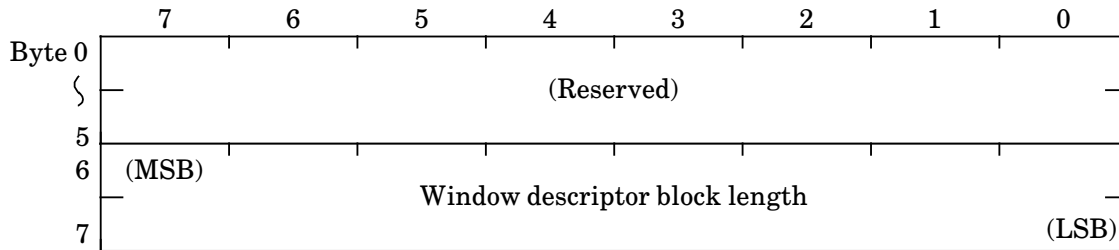

(a) Subwindow descriptor block length: Bytes 6 and 7

Specifies the length in bytes of a subwindow descriptor block. Each block has a same length. The allowable range of length is between 40 and 64 bytes. For a length outside this range, this scanner returns the following error information:

- Status: B'00001' (CHECK CONDITION)
- Sense key: X'5' (ILLEGAL REQUEST)

b. Subwindow descriptor block

Subwindow data (window descriptor block) is shown in the following illustration.

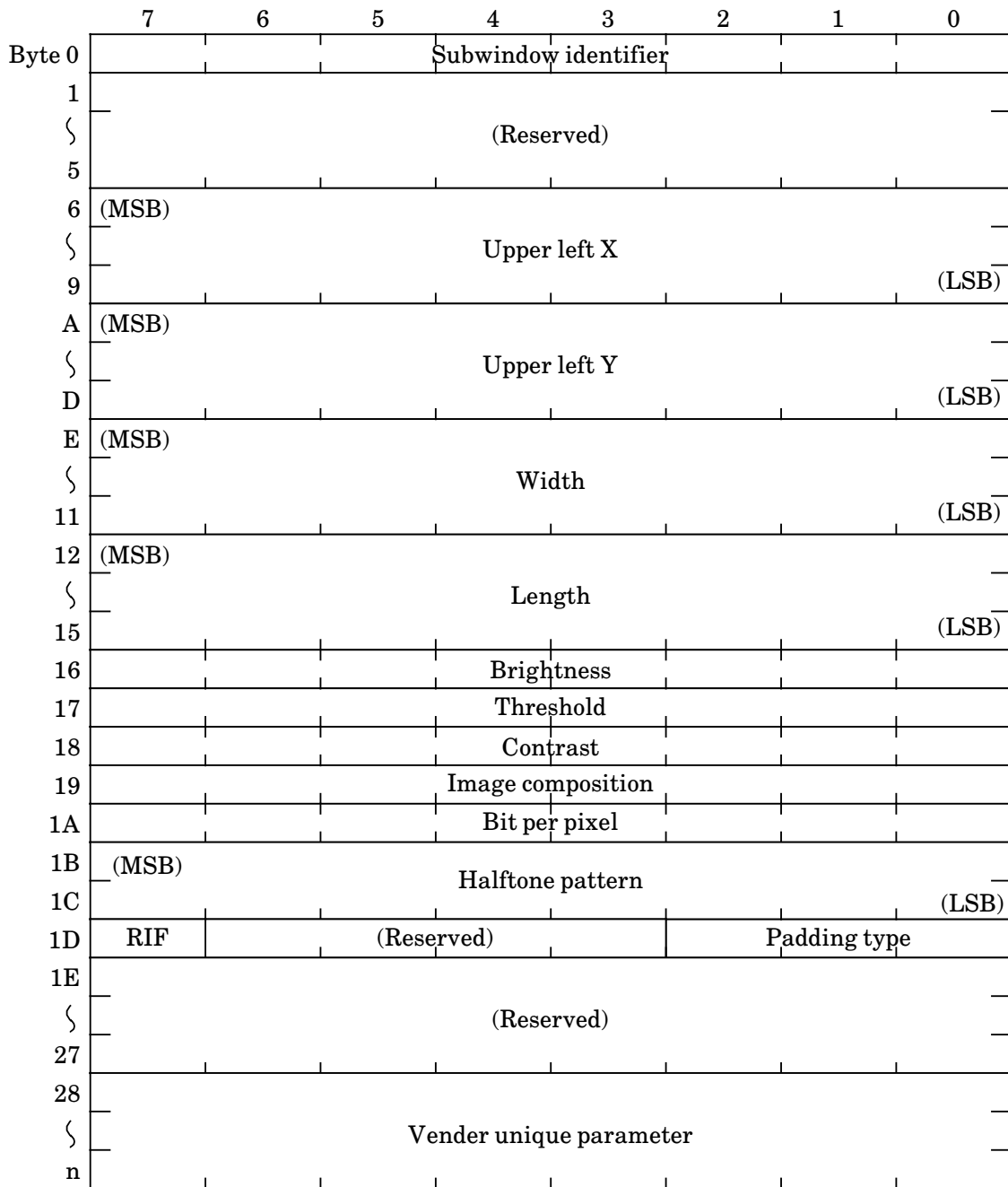

(a) Subwindow identifier: Byte 0

Specifies a unique value that identifies a subwindow. If two or more subwindow identifiers are specified for a single set of subwindow data, the most recently specified identifier is validated.

This scanner allows up to four subwindows for each main window to be set. Therefore, a value 0 to 3 is specified in this field. If a value 4 or greater is specified, this scanner returns the following error information:

- Status: B'00001' (CHECK CONDITION)
- Sense key: X'5' (ILLEGAL REQUEST)

(b) Upper left X, Y (ULX, ULY) : Bytes 6 to 9, A to D

Specified here are the X and Y coordinates of the upper-left corner of the subwindow. The coordinates are expressed in units of 1/1200 inches relative to the upper-left corner of the maximum scan area.

(c) Width, length (W, L) : Bytes E to 11, 12 to 15

Specified here are the width and length of the subwindow, in units of 1/1200 inches.

Notes:

1. If the area specified for any subwindow does not fit in the area of the main window, the portion of the area outside the main window area is ignored. Only the portion where the main and subwindow overlap (shown hatched) is processed.

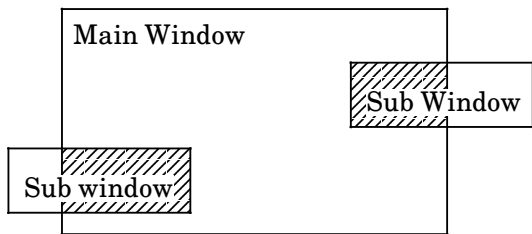

2. If subwindows in a main window overlap with each other as a result of the values ULX, ULY, W and L specified here, this scanner returns the following error information:

- Status: B'00001' (CHECK CONDITION)
- Sense key: X'5' (ILLEGAL REQUEST)

Example:

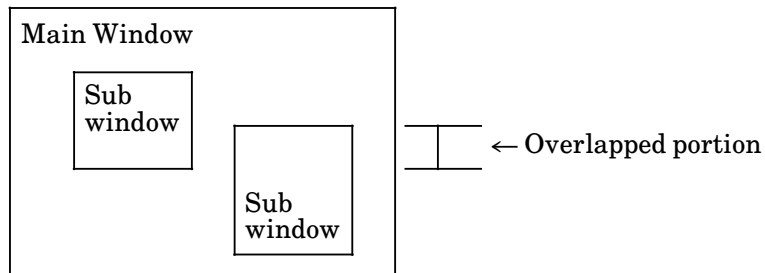

(d) Brightness: Byte 16

Specifies the brightness for half tone. For details, see the SET WINDOW command.

(e) Threshold: Byte 17

Specifies the threshold value for line art. For details, see the SET WINDOW command.

(f) Contrast: Byte 18

Specifies the contrast value for half tone or line art. For details, see the SET WINDOW command.

(g) Image composition: Byte 19

Specifies the type of image to be read. The following values are supported by this scanner:

X'00': Line art
X'01': Half tone

If a value X'02' or greater is specified, this scanner returns the following error information:

- Status: B'00001' (CHECK CONDITION)
- Sense key: X'5' (ILLEGAL REQUEST)

(h) Bit per pixel: Byte 1A

Specifies the number of bits per pixel. On this scanner, X'01' (1 bit) is specified since only binary data is valid for subwindows. If any other value is specified, this scanner returns the following error information:

- Status: B'00001' (CHECK CONDITION)
- Sense key: X'5' (ILLEGAL REQUEST)

(i) Half tone pattern: Byte 1B and 1C

Specify the halftone method and dithered pattern. For details, see the SET WINDOW command.

(j) RIF (reverse image format): Byte 1D

This bit is used to reverse the binary image data output.

0: Output is not reversed
1: Output is reversed

(k) Vender unique parameter: byte 28 and after

Specifies, in byte 28 and after, a vender unique identification parameter, including items such as outline, emphasis, and automatic separation, as required. This parameter is specified in the following format. This parameter does not need data until byte 3E. (It is unnecessary to transfer the unnecessary parameter but the intermediate parameter cannot be omitted.)

28	Vender unique identification code
29	γ Pattern number
2A	Outline extraction
2B	Image emphasis
2C	Automatic separation
2D	Reserved
2E	Variance rate
2F	Reserved
30	
31	
32	
33	
34	
35	
36	
37	
38	
39	
3A	
3B	
3C	
3D	
3E	DTC selection

- Vender unique identification code: byte 28

Specifies a vender unique identification code. For this scanner, X'00' must be specified. If other value is specified, this scanner returns the following error information:

- Status: 00001 (CHECK CONDITION)
- Sense key: X'5' (ILLEGAL REQUEST)

- γ pattern: byte 29

Specifies γ pattern number for subwindow. For details, see the explanation of the SET WINDOW command.

- Outline extraction: byte 2A

Specifies the outlining for the subwindow. For details, see the explanation of the SET WINDOW command.

- Image emphasis: byte 2B
Specifies the emphasis for the subwindow. For details, see the explanation of the SET WINDOW command.
- Automatic separation: byte 2C
Specifies the automatic separation for the subwindow. For details, see the explanation of the SET WINDOW command.
- Variance rate: byte 2E
Specifies variance rate for simplified dynamic threshold. For details, see the explanation of the SET WINDOW command.
- DTC selection: byte 3E

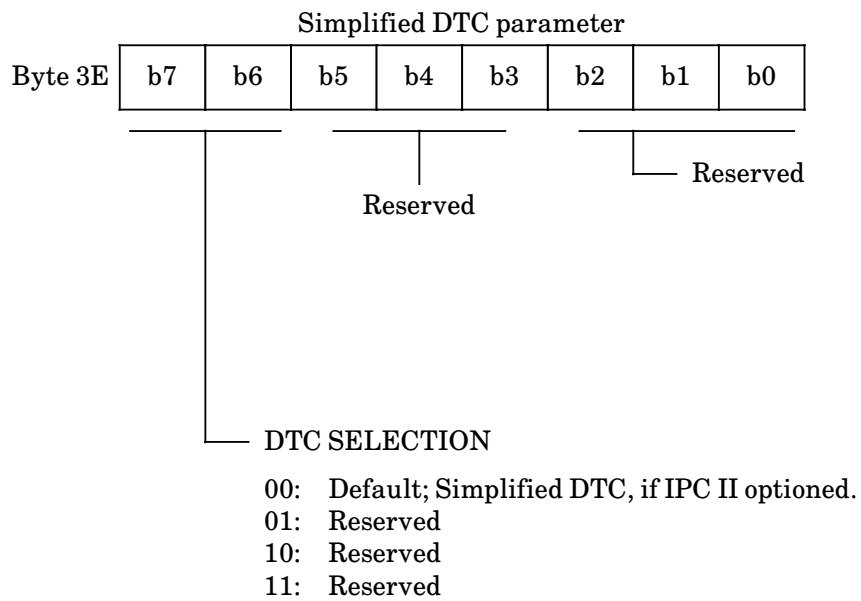

Note:

Dynamic threshold cannot select for subwindow.

4.4.9 OBJECT POSITION command

The following table shows the normal sequence of the OBJECT POSITION command when used with this scanner.

Step	Bus phase	Initiator operation	← →	Target operation
1	BUS FREE	Verifies bus free		
2	ARBITRATION	Obtains bus-usage right		
3	SELECTION	Selects target	→	
				Drives BSY signal
4	MESSAGE OUT	Selects logical unit	→	
5	COMMAND	Specifies OBJECT POSITION (CDB)	→	Loads/unloads paper (ADF)
6	STATUS		←	Reports GOOD status
7	MESSAGE IN		←	Reports message (Command Complete)
				Releases BSY signal
8	BUS FREE			

- (1) OBJECT POSITION command: COMMAND phase (initiator → target)

The OBJECT POSITION command controls the sheets in the ADF. When the ADF is used for reading, document sheets are loaded with this command before the READ command is issued.

The CDB of this command is shown in the following illustration.

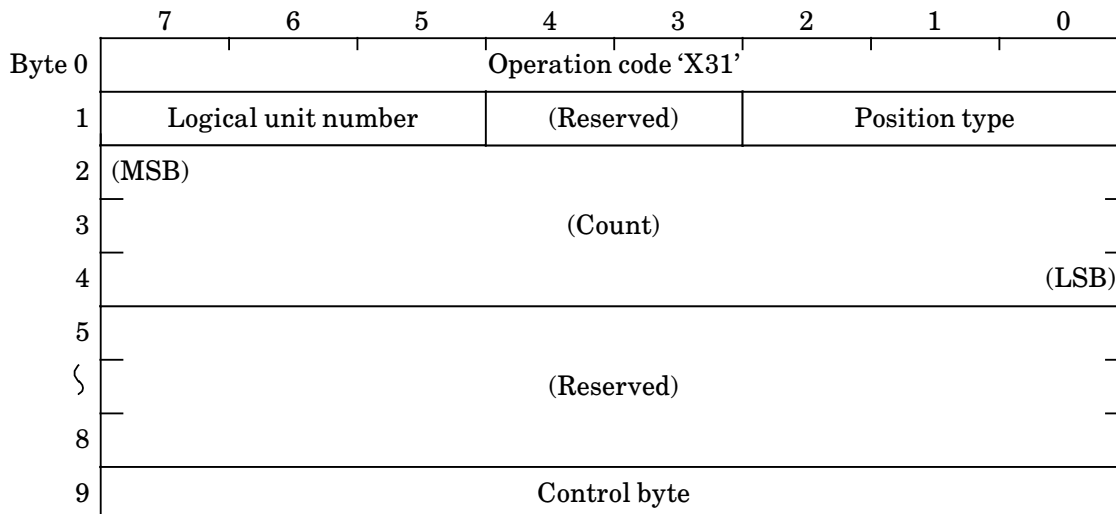

a. Position type: byte 1

Specifies positioning functions

Bit 2	Bit 1	Bit 0	POSITION TYPE
0	0	0	Unload object
0	0	1	Load object

This scanner supports the unload object and load object functions only. If an other value is specified, this scanner returns the following error information:

- Status: B'00001' (CHECK CONDITION)
- Sense key: X'5' (ILLEGAL REQUEST)

(a) Unload object

This scanner unloads a document from the ADF. If the ADF chuter does not contain a document when this command is received, this scanner does not generate an error but returns the GOOD status.

The unload object function is not vital to the scanner. After completion of reading with the READ command, the scanner automatically unloads the document.

(b) Load object

This scanner loads the document from the ADF paper chute. If a document is already loaded in the ADF when this command is received, this scanner does not generate an error but returns the GOOD status.

b. Count: bytes 2 to 4

This scanner does not support this field. If a value other than 0 is specified, this scanner returns the following error information:

- Status: B'00001' (CHECK CONDITION)
- Sense key: X'5' (ILLEGAL REQUEST)

(2) Response

This scanner reports the OBJECT POSITION command as follows:

a. Normal

The GOOD status is returned.

- Status: B'00000' (GOOD)
- Sense key: X'0' (NO SENSE)

b. Abnormal

The CHECK CONDITION status is returned and sense data is created.

- Status: B'00001' (CHECK CONDITION)
- Sense key: X'3' (MEDIUM ERROR)
(The cause of the error is jammed paper, an opened ADF cover, or an empty paper supply.)

(3) Command sequence to select the ADF or FB.

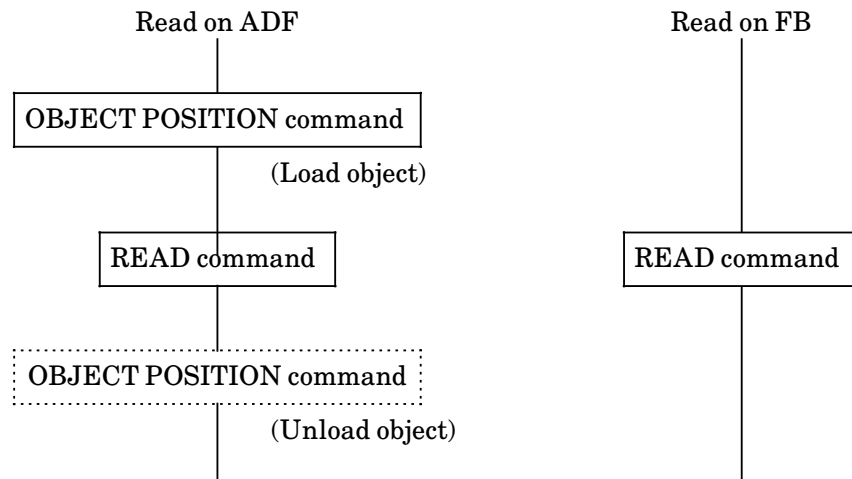

Note:

If the document is shorter than the window area specified by the SET WINDOW command, the deficient portion is supplemented by white data. The deficient portion is supplemented so that the data covers the entire specified window area and is transferred.

When the disconnecting is enabled by the IDENTIFY message, the disconnecting is performed during a loading or unloading operation and the reconnecting is performed after the operation is complete.

4.4.10 SEND command

The following table shows the normal sequence of the SEND command when used with this scanner.

Step	Bus phase	Initiator operation	← →	Target operation
1	BUS FREE	Verifies bus free		
2	ARBITRATION	Obtains bus-usage right		
3	SELECTION	Selects target	→	
				Drives BSY signal
4	MESSAGE OUT	Selects logical unit	→	
5	COMMAND	Specifies SEND (CDB)	→	
6	DATA OUT		→	Transfer data
7	STATUS		←	Reports GOOD status
8	MESSAGE IN		←	Reports Command Complete
				Releases BSY signal
9	BUS FREE			

(1) SEND command: COMMAND phase (initiator → target)

The SEND command is used by an initiator to send data to a target. The CDB of this command is shown in the following illustration.

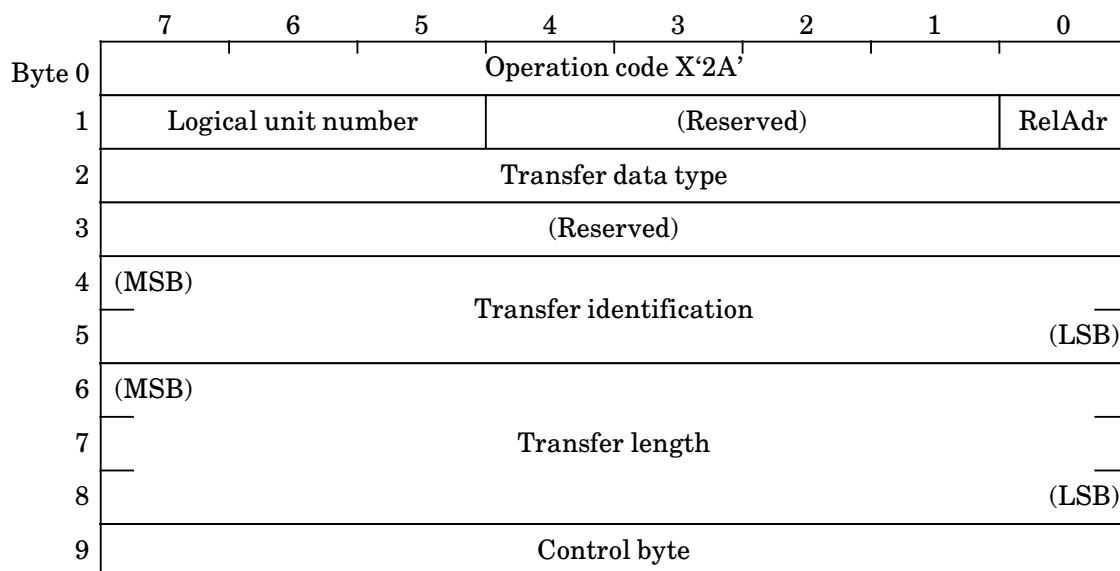

a. Transfer data type: Byte 2

Specifies the type of data to be transferred between the initiator and target. This scanner supports X'02' (dither pattern) and X'03' (γ pattern). If any other value is specified, this scanner returns the following error information:

- Status: B'00001' (CHECK CONDITION)
- Sense key: X'5' (ILLEGAL REQUEST)

b. Transfer identification: Byte 4 to 5

Identifies each data. On this scanner, this field is used to differentiate with a value from 0 to 4 downloadable dither patterns. If a value 5 or larger is specified, this scanner returns the following error information:

- Status: B'00001' (CHECK CONDITION)
- Sense key: X'5' (ILLEGAL REQUEST)

c. Transfer length (TL): Bytes 6 to 8

Specifies the bytes of data to be transferred by the initiator.

If $TL = 0$, no data is transferred. This is not regarded as an error.

If $TL > 1034$ (larger than a dither pattern of 32×32), this scanner returns the following error information:

- Status: B'00001' (CHECK CONDITION)
- Sense key: X'5' (ILLEGAL REQUEST)

(2) SEND data (dither pattern): DATA OUT phase (initiator → target)

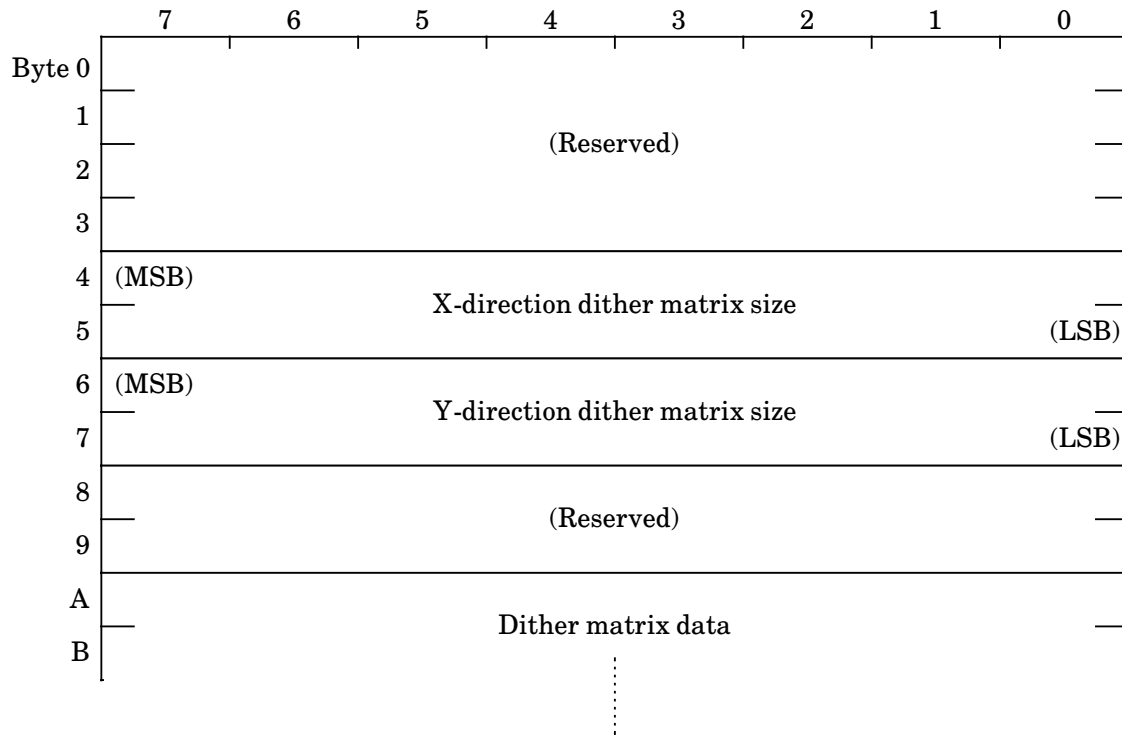

a. Dither matrix size

Specifies the size of dither matrix to be downloaded. This scanner supports 1×1 to 32×32 . If any other value is specified, this scanner returns the following error information:

- Status: B'00001' (CHECK CONDITION)
- Sense key: X'5' (ILLEGAL REQUEST)

b. Dither matrix data

Specifies the values of dither matrix in the range of 0 to 255, starting from the upper-left corner. (Value 0 represents the darkest, with 255 the brightest.)

The number of data values is the sum of the X- and Y-direction elements as specified in the matrix size fields. If the number of data values differs from that sum, this scanner returns the following error information:

- Status: B'00001' (CHECK CONDITION)
- Sense key: X'5' (ILLEGAL REQUEST)

Example:

d11	d12	d13	d14	d15	d16	d17	d18
d21	d22	d23	d24	d25	d26	d27	d28
d31	d32	d33	d34	d35	d36	d37	d38
d41	d42	d43	d44	d45	d46	d47	d48
d51	d52	d53	d54	d55	d56	d57	d58
d61	d62	d63	d64	d65	d66	d67	d68
d71	d72	d73	d74	d75	d76	d77	d78
d81	d82	d83	d84	d85	d86	d87	d88



DATA OUT phase

0	1	2	3	4	5	6	7	8	9
00	00	00	00	00	08	00	08	00	00

A	B	C	D	E	F	10	11
d11	d12	d13	d14	d15	d16	d17	d18
12	13	14	15	16	17	18	19
d21	d22	d23	d24	d25	d26	d27	d28
⋮							
42	43	44	45	46	47	48	49
d81	d82	d83	d84	d85	d86	d87	d88

(3) SEND data (γ pattern): DATA OUT phase (initiator → target)

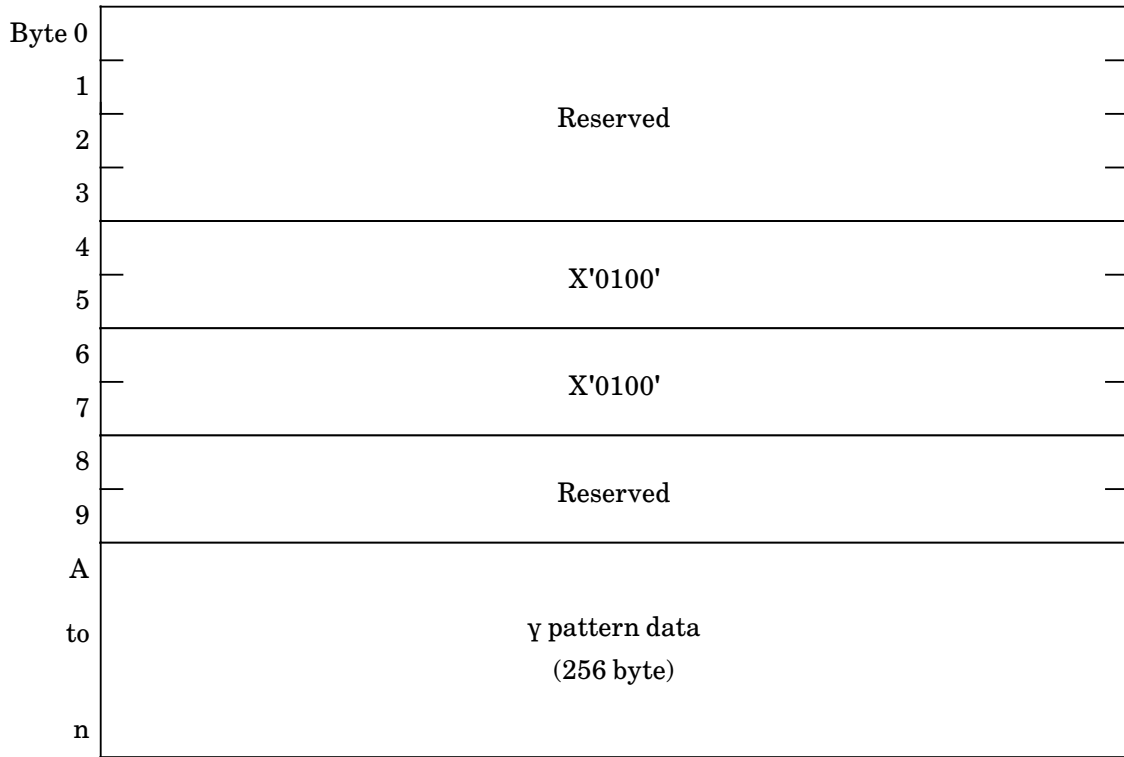

- γ pattern data

The γ pattern data must be transferred in the following order;

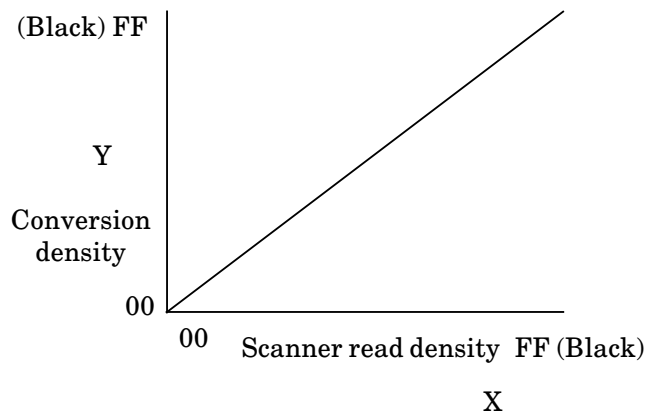
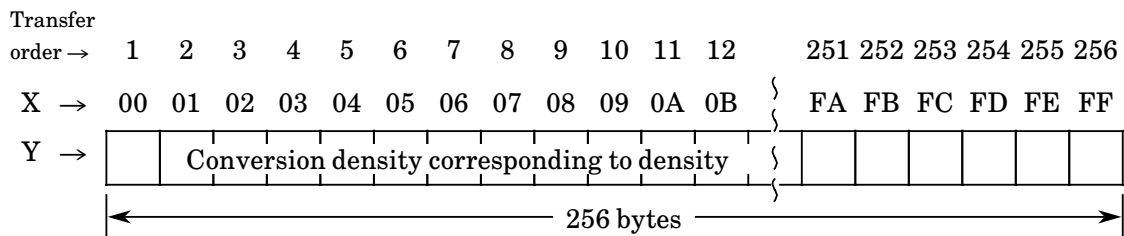

4.4.11 READ command

The following table shows the normal sequence of the READ command when used with this scanner.

Step	Bus phase	Initiator operation	← →	Target operation
1	BUS FREE	Verifies bus free		
2	ARBITRATION	Obtains bus-usage right		
3	SELECTION	Selects target	→	
				Drives BSY signal
4	MESSAGE OUT	Selects logical unit	→	
5	COMMAND	Specifies READ (CDB)	→	Reads document
6	DATA IN		←	Transfers image data
7	STATUS		←	Reports GOOD status
8	MESSAGE IN		←	Reports message (Command Complete)
				Releases BSY signal
9	BUS FREE			

- (1) READ command: COMMAND phase (initiator → target)

The READ command is used by an initiator to request a target for transfer of data. Upon receiving this command, the target returns scan data to the initiator.

The CDB of this command is shown in the following illustration.

	7	6	5	4	3	2	1	0
Byte 0	Operation code X'28'							
1	Logical unit number			(Reserved)			RelAdr	
2	Data type code							
3	(Reserved)							
4	(MSB) Data type qualifier (LSB)							
5								
6	(MSB) Transfer length (LSB)							
7								
8								
9	Control byte							

a. Data type code: Byte 2

Specifies the type of data to be transferred between the initiator and target. This scanner supports X'00' (image data), X'80' (pixel size), and X'81' (detected paper information) only. If any other value is specified, this scanner returns the following error information:

- Status: B'00001' (CHECK CONDITION)
- Sense key: X'5' (ILLEGAL REQUEST)

b. Data type qualifier: Bytes 4 to 5

This scanner requires specifying byte 4 = X'00' and byte 5 = window identifier. If the window identifier specified in byte 5 has not been declared by the DEFINE WINDOW PARAMETERS command, this scanner returns the following error information:

- Status: B'00001' (CHECK CONDITION)
- Sense key: X'5' (ILLEGAL REQUEST)

c. Transfer length (TL): Bytes 6 to 8

Specifies the bytes of storage area that the initiator has allocated for the data to be transferred.

If TL = 0, no data is transferred. This is not assumed an error.

The target does not transfer more data than that which is indicated by TL.

If the actual transfer amount differs from the amount indicated by TL, the target creates the following status and sense data:

- Status: B'00001' (CHECK CONDITION)
- Sense key: X'0' (NOSENSE)
- Sense data (VALID): 1
- Sense data (ILI): 1 (Difference in transfer amount)
- Sense data (INFORMATION): TL indicated transfer amount subtracted by actual transfer amount

Note:

For the read sequence, see Section 4.7.3.

(2) DATA IN phase (target → initiator)

- a. Image data: (DATA TYPE CODE = X'00')
(Not compressed)

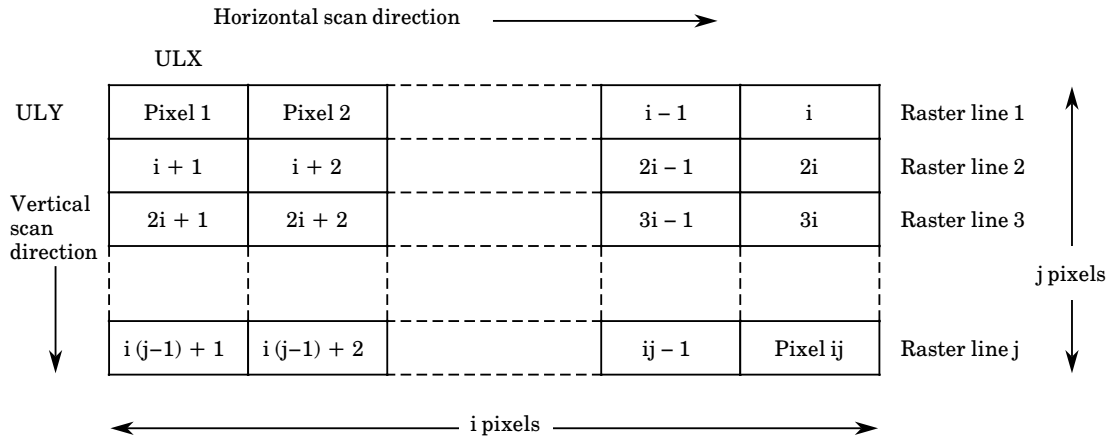

The following format is the data format that this scanner uses when transferring the image data of a window comprising $i \times j$ pixels.

(a) For binary data

1 pixel: 1 bit

8 pixels: 1 byte

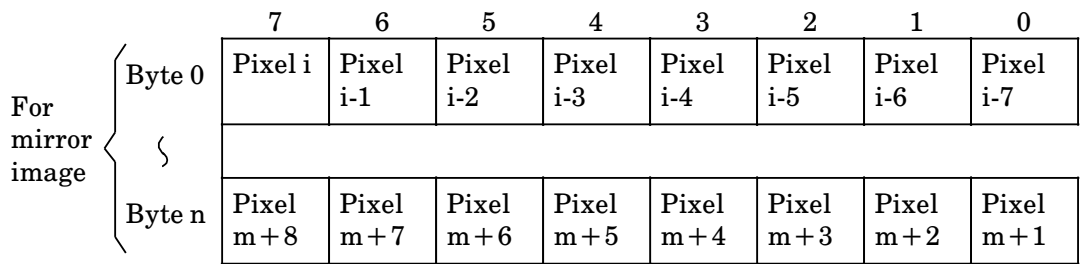
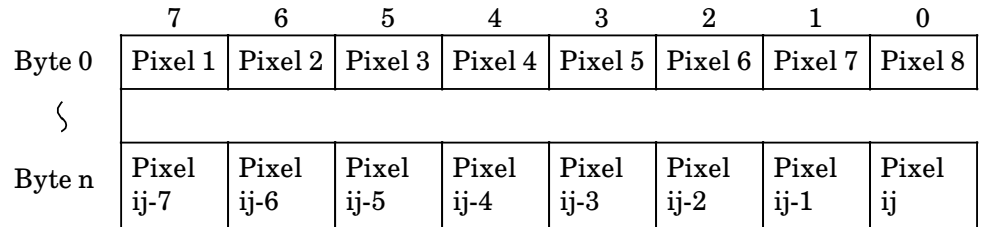
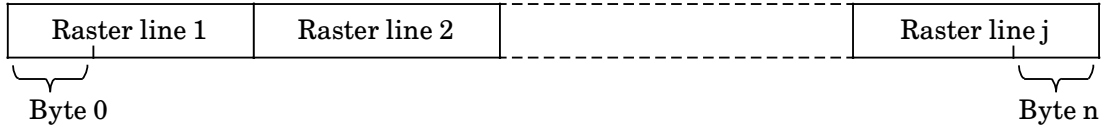

If the data amount per raster line is not a multiple of 8 bits, the window is raised to a multiple of 8 bits.

b. Pixel size data: (DATA TYPE CODE = X'80')

This scanner calculates the numbers of X-direction pixels and Y-direction pixels of the image data to be transferred to the initiator. The scanner performs this calculation by referencing the resolution and area set up with the SET WINDOW command. This data need not be issued if the numbers of pixels are known by the initiator.

The transfer format for this data is shown in the following illustration.

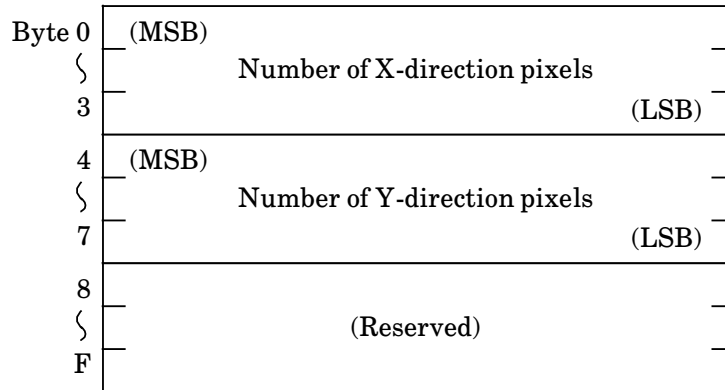

c. Detected paper information (DATA TYPE CODE = X'81')

This scanner detects the paper size and the job separation sheet when OBJECT POSITION (load object) is received.

Read (DATA TYPE CODE = X'81') command is used to get detected paper information from this scanner.

Detected paper information shown below:

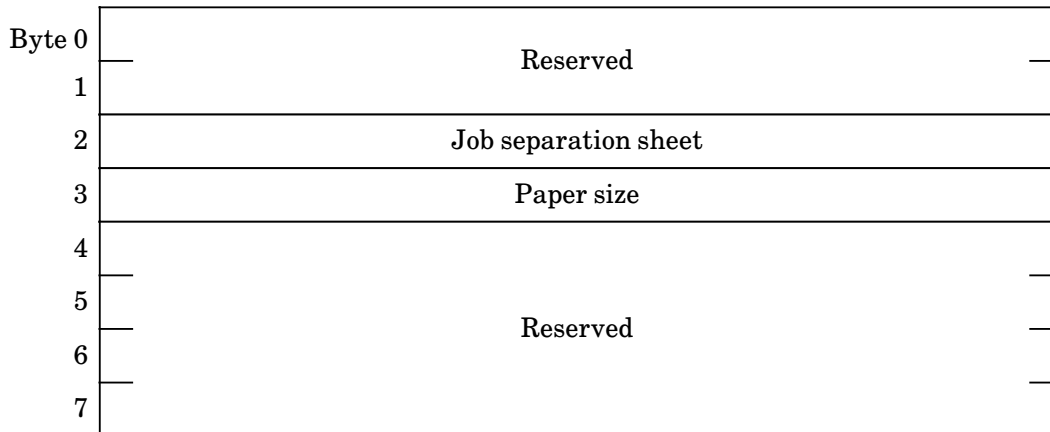

- Job separation sheet: Byte 2

X'80': Job separation sheet detected.

X'00': Job separation sheet not detected.

● Paper size: Byte 3

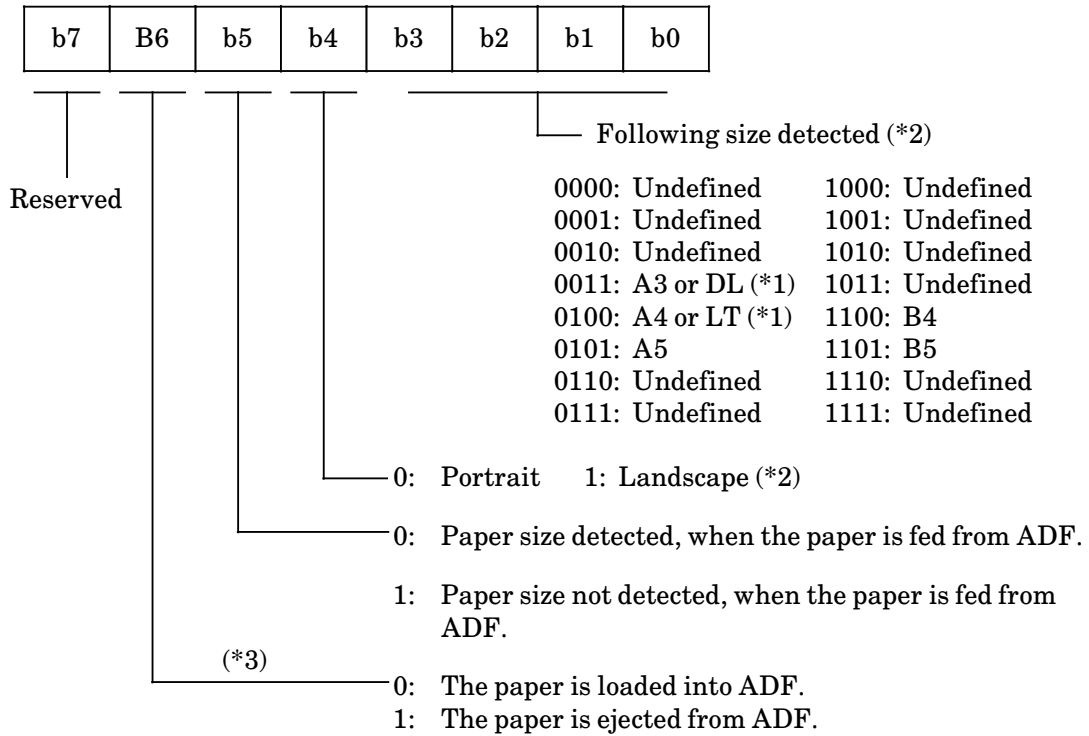

Notes:

- *1 This scanner cannot distinguish DL from A3, or LT from A4.
- *2 When the paper is loaded into ADF by Object position (Load object), this scanner detects paper size assuming the orientation is portrait. After the paper is ejected from ADF by Object position (Unload object), this scanner detects the orientation, and paper size.
- *3 This bit (b6) only valid after Object position (Load/unload object) is completed.

4.4.12 MODE SELECT (6)

The normal sequence related to MODE SELECT (6) of this scanner is listed below:

Procedure	Bus phase	Initiator's operation	← →	Target's operation
1	Bus Free	Checks Bus Free		
2	Arbitration	Acquires right to use the bus		
3	Selection	Selects the target	→	
				Outputs the BSY signal
4	Message Out	Selects the logical device	→	
5	Command	Specifies MODE SELECT (6) (CDB)	→	Sets up mode data
6	Data In	Specifies MODE SELECT parameter data	→	
7	Status		←	Reports the GOOD status
8	Message In		←	Reports Command Complete
				Releases the BSY signal
9	Bus Free			

- (1) MODE SELECT (6) command: Command phase (Initiator to Target)

This command is used to set up miscellaneous parameters in peripheral devices.

CDB of this command is shown below:

	7	6	5	4	3	2	1	0
Byte 0	Operation code X'15'							
1	Logical unit number			PF	(Reserved)			SP
2	(Reserved)							
3								
4	Parameter list length							
5	Control byte							

- PF (PAGE FORMAT): Byte 1

When PF = 1, it is indicated that the parameters of this command is fitted to the SCSI-2 specification.

For this scanner, PF = 1 only is supported.

Otherwise, the following error is returned:

- Status: B'00001' (CHECK CONDITION)
- Sense key: X'5' (ILLEGAL REQUEST)

- SP (SAVE PAGES): Byte 1

This scanner ignores SP.

- PARAMETER LIST LENGTH: Byte 4

Specifies the number of bytes of the mode parameter list sent in the DATA OUT phase.

0 means that there is no data to be transferred. This is not regarded as an error.

(2) Mode parameter list data: DATA OUT phase (Initiator to Target)

The mode parameter list data consists of one header, 0 or more than one descriptor block, and 0 or more than one page as one unit.

In this scanner, the descriptor block and vendor-specific area are omitted, thus the mode parameter list data consists of one header and one page.

a. Header

The mode parameter data (header) is shown below:

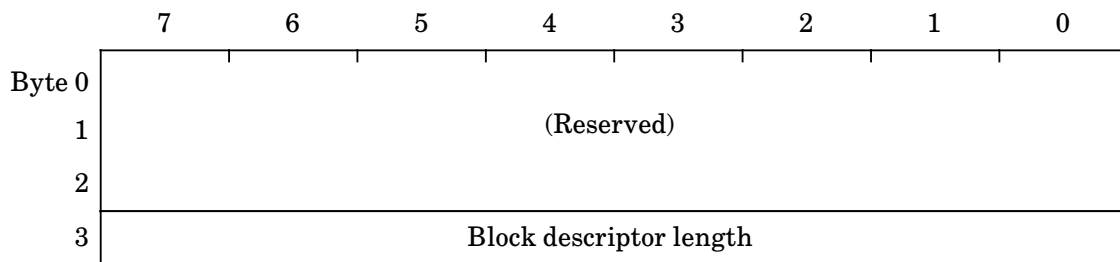

- **BLOCK DESCRIPTOR LENGTH: Byte 3**

Specifies the length of the entire mode parameter descriptor block in units of byte. The page and vendor-specific parameter are not included.

In this scanner, 0 is specified and the succeeding mode descriptor section shall be omitted.

- b. Mode parameter descriptor block (Omitted in this scanner)

The mode parameter data (mode descriptor block) is shown below:

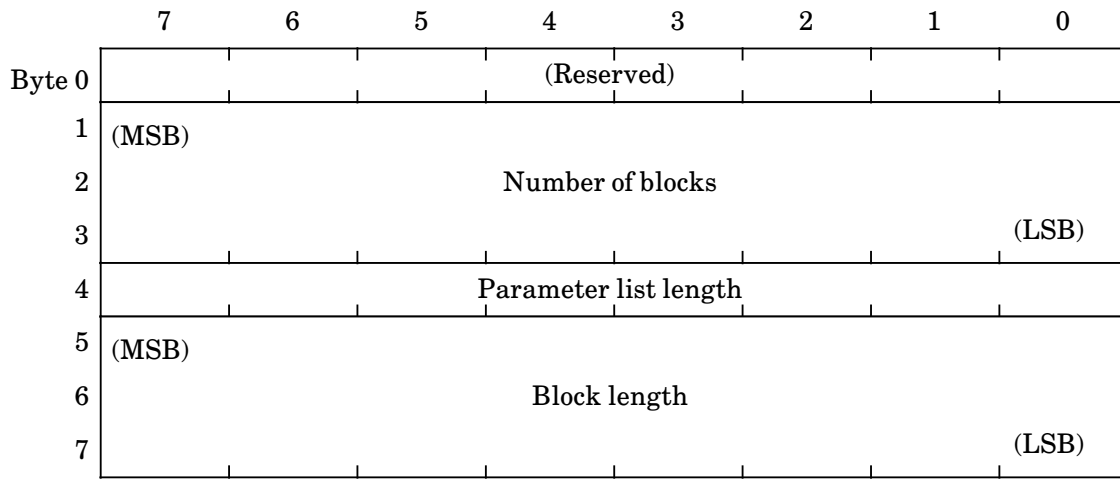

- **NUMBER OF BLOCKS: Byte 1 to 3**

Specifies the number of logical blocks fitted for the DENCITY CODE and BLOCK LENGTH.

- **BLOCK LENGTH: Bytes 5 to 7**

Specifies the length of the logical blocks described in the BLOCK DESCRIPTOR in units of byte.

Note: In this scanner, this descriptor is omitted.

c. Mode page

The mode page format is indicated for each page code.

- Page code

The PAGE CODEs supported in this scanner are as follows:

Page code	Description
X'00'	Don't care (IGNORE)
X'01'	Reserved
X'02'	Not supported
X'03'	Not supported
X'04' to X'3C'	Reserved
X'3D'	Lamp timer
X'3E'	Job separation sheet
X'3F'	Reserved

Each page is described below.

① Lamp timer PAGE (PAGE CODE X'3D')

	7	6	5	4	3	2	1	0
Byte 0	(Reserved)		Page code (X'3D')					
1	Parameter length (X'06')							
2	Lamp timer							
3 to 7	(Reserved)							

- LAMP TIMER: Byte 2

The time during which the fluorescent lamp lights. 0: default (60 seconds). Up to 255 seconds can be set up in units of second.

- ② Job separation sheet (PAGE CODE X'3E')

	7	6	5	4	3	2	1	0
Byte 0	(Reserved)		Page code (X'3E')					
1	Parameter length (X'06')							
2	Parameter							
3 to 7	(Reserved)							

- PARAMETER: Byte 2

X'80': Reports check condition status when detects job separation sheet.

X'00': Does not report check condition status when detects job separation sheet.

Spec. of job separation sheet shown in A.5.

4.4.13 MODE SENSE (6)

The normal MODE SENSE (6) sequence for the scanner is as follows:

Procedure	Bus phase	Initiator operation	↔	Target operation
1	Bus Free	Checks Bus Free		
2	(Arbitration)	Acquires the bus use right		
3	Selection	Selects the target	→	
				Drives the BSY signal
4	(Message Out)	Selects the logical device	→	
5	Command	Specifies MODE SENSE (6) (CDB)	→	Reports mode data
6	Data In	Reports MODE SENSE parameter data	←	
7	Status		←	Reports GOOD status
8	Message In		←	Reports message (Command complete)
				Releases the BSY signal
9	Bus Free			

(1) MODE SENSE (6) command: Command phase (Initiator to Target)

The MODE SENSE (6) command is used for the target to report mode parameters to the initiator.

The command descriptor block (CCD) is as follows:

	7	6	5	4	3	2	1	0
Byte 0	Operation code X'1A'							
1	Logical unit number			Reserved	DBD	Reserved		
2	PC		Page code					
3	Reserved							
4	Allocation length							
5	Control byte							

- DBD (disable block descriptor): Byte 1

When the DBD bit is 1, the target must not return the mode descriptor block in the Data In phase. When this bit is 0, the target may or may not return the block.

This bit must be 0.

- PC (page control): Byte 2

PC specifies the type of parameter returned, defined as follows:

PC	Parameter type
00	Current value
01	Changeable value
10	Default
11	Saved value

Only 00 (current value) can be set. Other values cause the following error:

Status: B'00001' (CHECK CONDITION)

Sense key: X'05' (ILLEGAL REQUEAT)

Page code: Byte 2

The page code specifies the page to be reported. The following are supported:

Page code	Description
X'00'	Don't care (IGNORE)
X'01'	Reserved
X'02'	Not supported
X'03'	Not supported
X'04' to X'3D'	Reserved
X'3D'	Lamp timer
X'3E'	Job separation sheet
X'3F'	Reserved

- Allocation length: Byte 4

The allocation length specifies the storage area allocated by the initiator for the mode sense data in bytes.

0 means no data is transferred. This is not an error.

The target terminates the DATA IN phase when mode sense data for the number of bytes specified in this field is transferred or when the transfer of all valid mode sense data is completed.

(2) Mode data: DATA IN phase (Target to Initiator)

Mode parameter list data consists of a header, 0 or more than one descriptor block, and 0 or more than one page.

a. Header

Mode parameter data (header) is as follows:

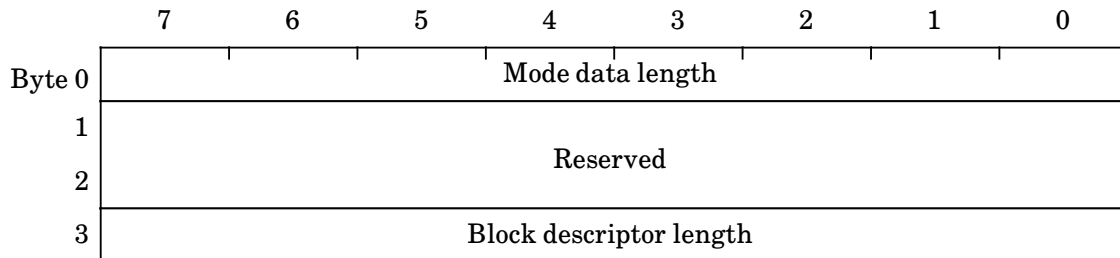

- Mode data length: Byte 0

The length of available data to be successively transferred is specified in the mode data length in bytes. The mode data length itself is not included.

- Block descriptor length: Byte 3

The block descriptor length specifies the length of the entire mode parameter descriptor block in bytes. The page and vendor-specific parameter are not included.

0 is specified.

b. Mode parameter descriptor block (omitted in this scanner)

The mode parameter data (mode descriptor block) is as follows:

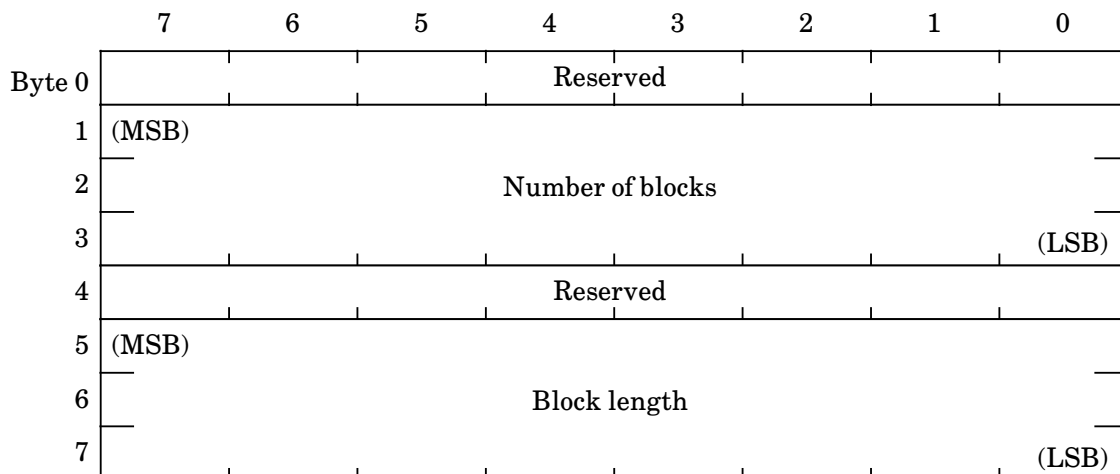

- Number of blocks: Bytes 1 to 3

The number of logical blocks is specified fitted for the density code and block length.

- Block length: Bytes 5 to 7

The block length specifies the length of the logical blocks in the block descriptor in bytes.

Note: This descriptor is omitted.

c. Mode page

The mode page format is as follows:

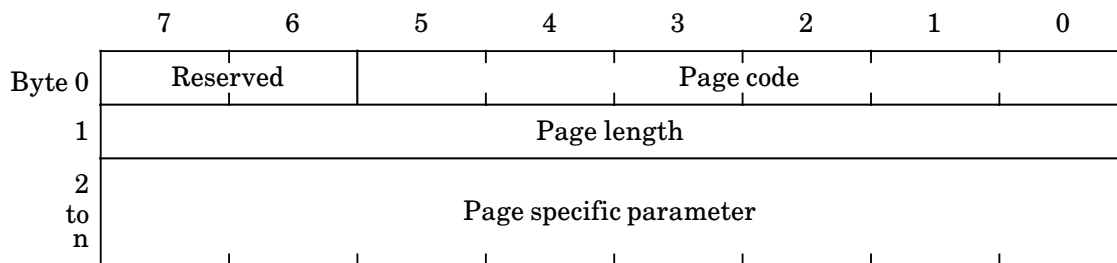

- Page code: Byte 0
- Page length: Byte 1
- Mode parameter: Byte 2

For definitions, see Section 4.4.12, “Mode select (6).”

4.5 Status: STATUS phase (target → initiator)

Each time a command is terminated, the target moves into the STATUS phase and returns a status byte to the initiator to report the completion of the command.

Status byte

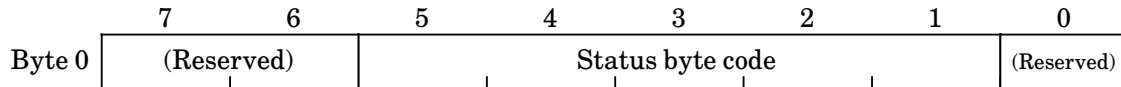

The status supported by this scanner are summarized in the following table.

Code	Status of unit
000000	<p>GOOD</p> <ul style="list-style-type: none"> ● The command has successfully terminated.
000001	<p>CHECK CONDITION</p> <p>a) The command has abnormally terminated. b) An abnormal condition was detected before a unit is selected.</p> <ul style="list-style-type: none"> ● The target detected an error before start of command-controlled processing. ● A unit that switched from the NOT READY status to the READY status was selected for the first time. ● A unit that received a RESET CONDITION or a BUS DEVICE RESET message was selected for the first time.
00100	<p>BUSY</p> <p>A target or logical unit cannot accept a new command.</p> <ul style="list-style-type: none"> ● The logical unit is executing processing. ● The target is executing processing on a specified logical unit or other logical unit. ● The target intends to report to an other initiator the sense data of a specified logical unit. ● The target intends to report to an other initiator the sense data of a logical unit that was not specified. ● The target intends to report the status to any initiator.
01100	<p>RESERVATION CONFLICT</p> <ul style="list-style-type: none"> ● The specified unit is already reserved by another initiator.

When a target is released from the BUSY status, it will not issue a notification of the release. Therefore, the initiator needs to check the status of units periodically and needs to issue the command again.

4.6 Messages

This section describes the detection of an ATN signal and explains the types of messages supported by this scanner.

4.6.1 ATN detection

The following table summarizes the timing at which this scanner detects an ATN signal.

Phase	ATN detection timing
SELECTION	Immediately before a phase change
COMMAND	Immediately before a phase change
DATA OUT	Immediately before a phase change
DATA IN	Immediately before a phase change (*1)
STATUS	Immediately before a phase change
MESSAGE OUT	Upon each reception of a message
MESSAGE IN	Upon each transmission of a message

*1 This scanner detects ATU signal for every Read command during an image data transmission. When an ATN signal is detected, scanning operation is interrupted.

4.6.2 Message types

Messages provide information consisting of one or more bytes that are transferred in the MESSAGE IN and MESSAGE OUT phases. These messages are used to control the bus phase sequence.

The initiator creates an ATTENTION condition for the target, indicating that it has a message to be reported to the target. Only then the target switches to the MESSAGE OUT phase to receive the message.

If the target has completed the SELECTION/RESELECTION phase, it can execute the MESSAGE IN phase at any time to send the message to the initiator.

The messages that can be communicated with this scanner are listed in the following table.

Code	Message
00	COMMAND COMPLETE
05	INITIATOR DETECTED ERROR
06	ABORT
07	MESSAGE REJECT
08	NO OPERATION
09	MESSAGE PARITY ERROR
0C	BUS DEVICE RESET
80 to FF	IDENTIFY
04	DISCONNECT
02	SAVED DATA POINTER
03	RESTORE POINTERS

- (1) **COMMAND COMPLETE (X'00') : MESSAGE IN phase (target → initiator)**

This message indicates that a command has been terminated and a valid status has been reported to the initiator.

The target always reports the **COMMAND COMPLETE** message after the **STATUS** phase at the completion of the input/output operation. (This requirement also applies if the **COMMAND** phase is not executed because of a command cannot be received.)

Upon receiving the **COMMAND COMPLETE** message, the initiator knows that a command has terminated.

After sending the **COMMAND COMPLETE** message, the target switches into the **BUS FREE** phase.

If the **COMMAND COMPLETE** message is rejected with the **MESSAGE REJECT** message, this scanner switches into the **BUS FREE** phase.

- (2) **INITIATOR DETECTED ERROR (X'05') : MESSAGE OUT phase (initiator → target)**

This message indicates that the initiator detected a retrievable error and intends to request the target for retry. The value of the current pointer is not guaranteed.

The initiator does not intend to issue another message by activating **ATN** before it deactivates the **ACK** of the **INITIATOR DETECTED ERROR** message.

When this scanner receives the INITIATOR DETECTED ERROR message, this scanner enters the MESSAGE IN phase and sends the RESTORE POINTERS message to the initiator. Then this scanner returns to the original phase and makes a retry.

After issuing the RESTORE POINTERS message, this scanner takes action as shown in the following table.

ATN detection phase	Action
SELECTION	Moves to the BUS FREE phase
COMMAND	Discards the CDB already received and returns to the COMMAND phase
DATA OUT	Discards the data already received and returns to the DATA OUT phase
DATA IN	<ul style="list-style-type: none"> ● When transferring image data, enters the DATA IN phase. If the memory option is provided, transfers image data again. If no memory option is provided, moves to the STATUS phase (Check Condition) → MESSAGE IN phase (Command Complete) → BUS FREE phase and keeps the sense key X'B' (Aborted Command). ● When transferring inquiry data or sense data, returns to the DATA IN phase and transfers data again
STATUS	Returns to the STATUS phase and sends the status byte again
MESSAGE OUT	Ignores this message (does not issue the RESTORE POINTERS message)
MESSAGE IN	Returns to the MESSAGE IN phase and sends the message byte again

(3) **ABORT (X'06') : MESSAGE OUT phase (initiator → target)**

The initiator requests the target to clear the input/output operation of the specified I/O unit (i.e., the input/output operation ordered by the initiator that issued this message) and to move to the BUS FREE phase. Input/output operations ordered by other initiators are not affected.

If a logical unit is not identified before the ABORT message, the target merely moves to the BUS FREE phase.

If no operation to be cleared, an error does not occur.

The initiator does not intend to issue another message by activating ATN before it deactivates the ACK of the ABORT message.

This scanner does not have a function that clears input/output operation for certain initiators. The scanner must have been reserved when it is operated in multi-initiator environment.

(4) MESSAGE REJECT (X'07) : MESSAGE IN/OUT phase (initiator → target)

This message indicates that a transferred message was rejected by the receiver as invalid or unexecutable.

The initiator does not intend to issue another message by activating ATN before it deactivates the ACK of the MESSAGE REJECT message.

Upon receiving the MESSAGE REJECT message, this scanner takes action as shown in the following table.

Message rejected	Action
COMMAND COMPLETE	Moves to the BUS FREE phase. (It is not assumed as an error.)
MESSAGE REJECT	Responds the CHECK CONDITION status
DISCONNECT	The command execution is continued with connecting the SCSI bus (without disconnecting).
SAVE DATA POINTER	The command execution is continued with connecting the SCSI bus (without disconnecting).
IDENTIFY	When this message is issued for reconnection, the command is terminated with an error. In this case, the reconnection for the command is not performed
RESTORE POINTERS	The error recover is interrupted and the CHECK CONDITION status is responded.
No message issued	Moves to the BUS FREE phase

(5) NO OPERATION (X'08') : MESSAGE OUT phase (initiator → target)

This message is issued in response to a message request from the target and indicates that the initiator does not have a valid message.

The initiator does not intend to issue another message by activating ATN before it deactivates the ACK of the NO OPERATION message.

(6) MESSAGE PARITY ERROR (X'09'): MESSAGE OUT phase (initiator → target)

This message indicates that the initiator detected a parity error in the message received. The target resends only that message.

The initiator does not intend to issue another message by activating ATN before it deactivates the ACK of the MESSAGE PARITY ERROR message.

Upon receiving the MESSAGE PARITY ERROR message, this scanner takes action as shown in the following table.

Phase when ATN is detected	Action
MESSAGE IN	Moves to the MESSAGE IN phase and resends the message (*1)
Other	Moves to the BUS FREE phase

*1 This scanner retries three times with the message in the MESSAGE IN phase. If the third retry fails, this scanner immediately moves to the BUS FREE phase.

(7) BUS DEVICE RESET (X'0C'): MESSAGE OUT phase (initiator → target)

This message addresses any initiators that are operating, or waiting for operation, on the target. The message initializes those initiators by resetting their input/output operations.

The BUS DEVICE RESET message is transferred in the asynchronous mode.

This scanner generates the UNIT ATTENTION condition to all initiators.

After being initialized, the initiators move to the BUS FREE phase.

The initiators do not intend to issue another message by activating ATN before they deactivate the ACK of the BUS DEVICE RESET message.

(8) IDENTIFY (X'80' to X'FF'): MESSAGE OUT phase (initiator → target)

This message specifies either a logical unit under control of the target, or a process incorporated in the target (maintenance, self-diagnostic, etc.).

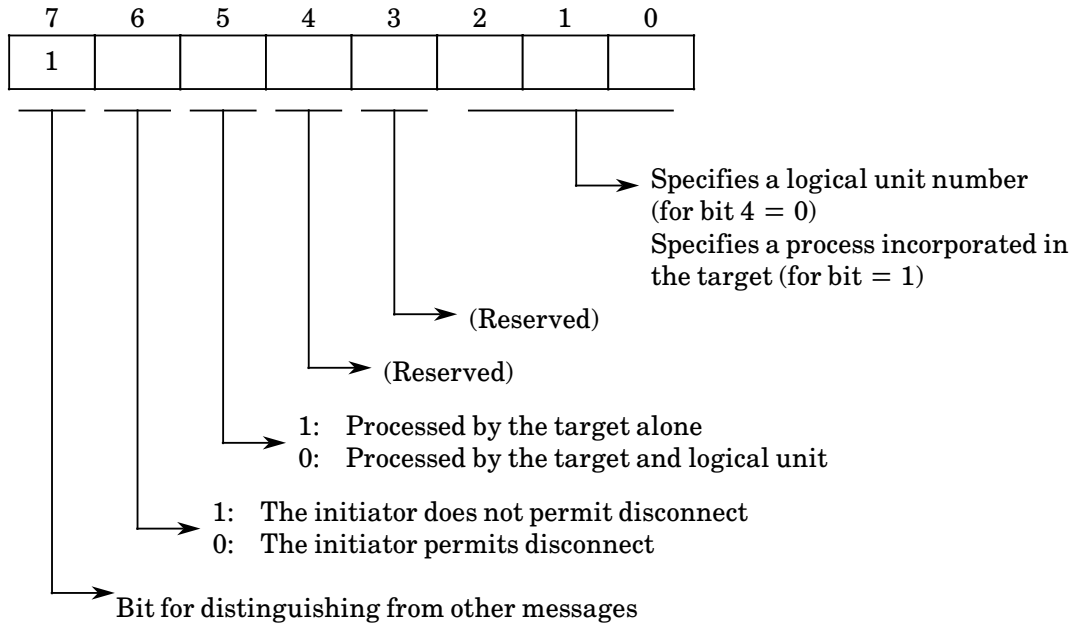

This scanner does not support the target-incorporated process function. Therefore, if a 1 is set in bit 5, the IDENTIFY message is rejected with the MESSAGE REJECT message.

(9) DISCONNECT (X'04'): MESSAGE IN phase (target → initiator)

Sent from the target to the initiator, this message indicates that the current link will be disconnected but it will later have to be reconnected to complete the current process.

After successfully sending the DISCONNECT message, the target releases the BSY signal to switch into the BUS FREE phase. The target assumes the message transfer to be successful if it detects that the ATN signal as well as the ACK signal from the DISCONNECT message are false.

This scanner issues the DISCONNECT message if bit 6 (DiscPriv) in the IDENTIFY message from the initiator is 1 and if a long time is expected for processing in the scanner (e.g., when the scanner receives the READ command and prepares data to be transferred to the initiator).

The link will not be disconnected if bit 6 in the IDENTIFY message is 0. Also, it will not be disconnected if the IDENTIFY message is not issued in a given command sequence. For disconnect to occur therefore, bit 6 in the IDENTIFY message must be set to 1.

When performing the disconnection during data transfer, this scanner sends the SAVE DATA POINTER message before sending the DISCONNECT message so that the data pointer is saved.

Example:

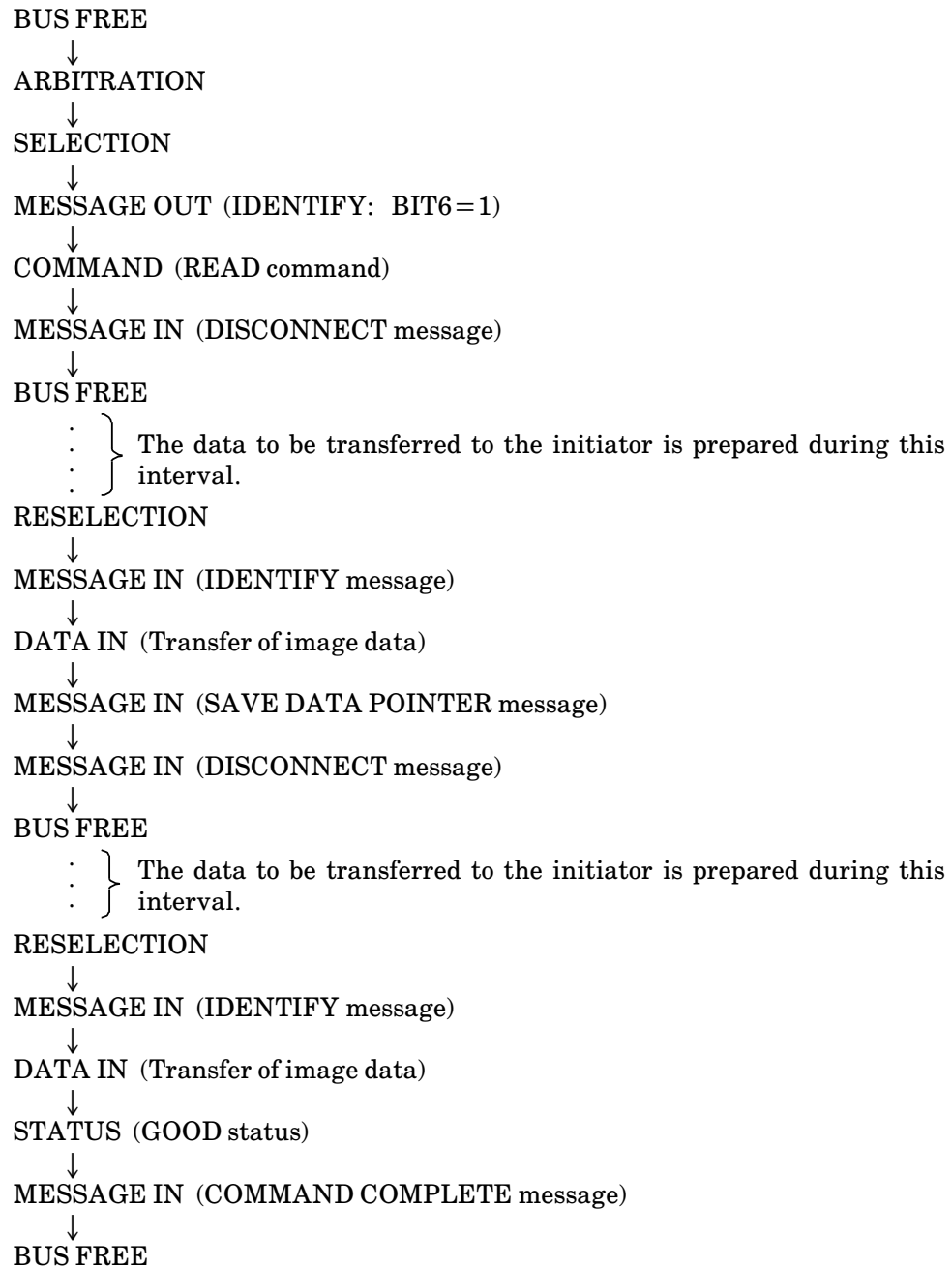

Note:

When no CMP II option is provided, the disconnection is not performed.

(10) **SAVE DATA POINTER (X'02') : MESSAGE IN phase (target → initiator)**

This message is sent from the target to the initiator in order to save the current data pointer. The initiator saves the current data pointer value into the saved pointer for the logical unit currently connected.

When the disconnection is enabled by the IDENTIFY message and this scanner cannot prepare data to be transferred in the DATA IN phase, this scanner issues the DISCONNECT message after issuing the SAVE DATA POINTER message so that the SCSI bus is released.

Notes:

1. When no memory option is provided, this scanner does not issue the SAVE DATA POINTER message.
2. When the required data for the READ command is less than 64 KB, this scanner does not issue the SAVE DATA POINTER message.

(11) **RESTORE POINTERS (X'03') : MESSAGE IN phase (target → initiator)**

The initiator restores the saved pointer by using this message. The initiator restores the command data status pointer value from the saved pointer for the logical unit connected when this message is received. The initiator stores the value into the current pointer.

Note:

This scanner issues the RESTORE POINTER message only during error recovery when the INITIATOR DETECTED ERROR message has been received.

4.7 Command Sequence

This section describes the initial sequence and read sequence.

4.7.1 Initial sequence

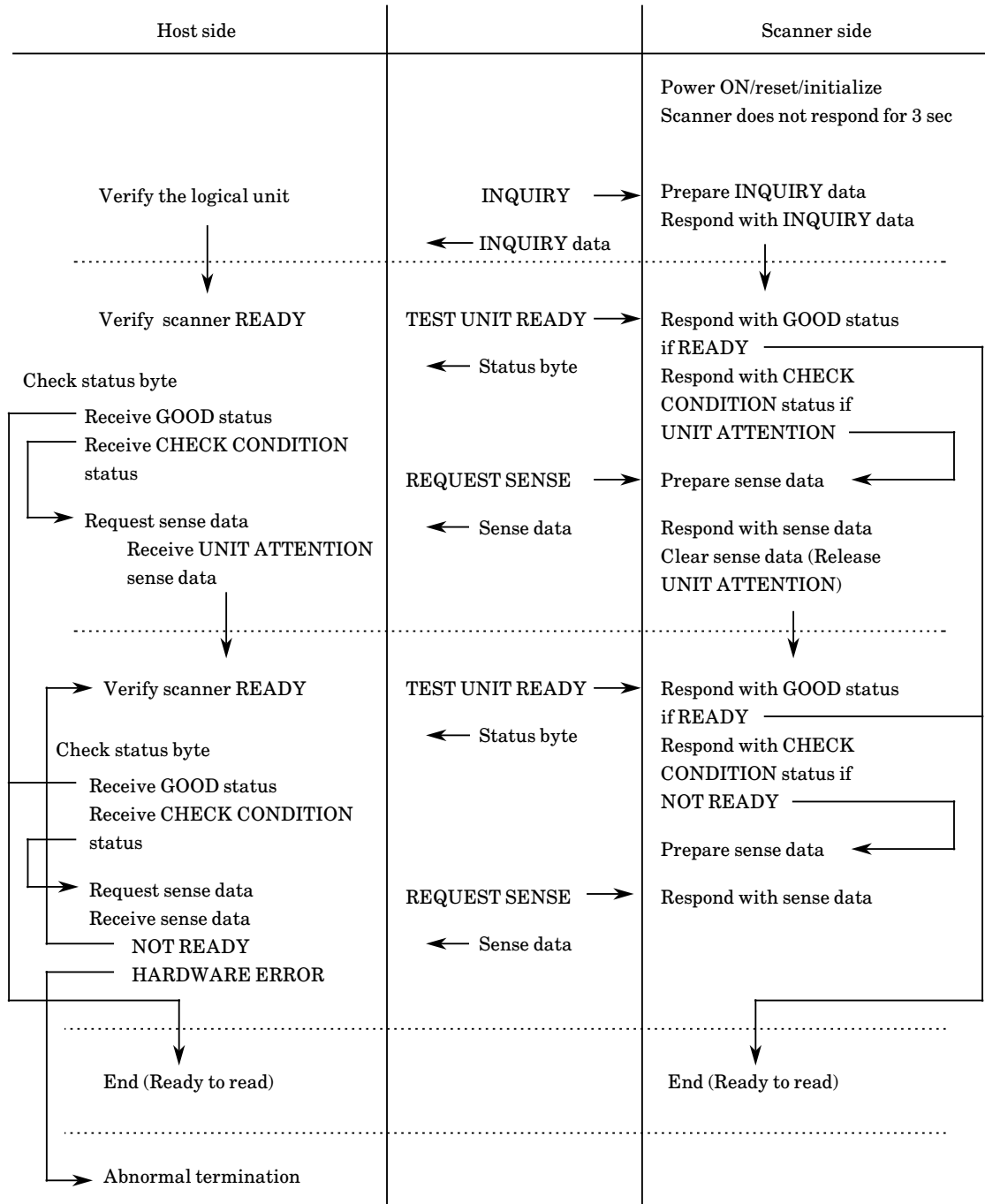

4.7.2 Command sequence to read

The following illustration is an example of the command sequence used with this scanner. All commands are assumed to be issued from a single initiator.

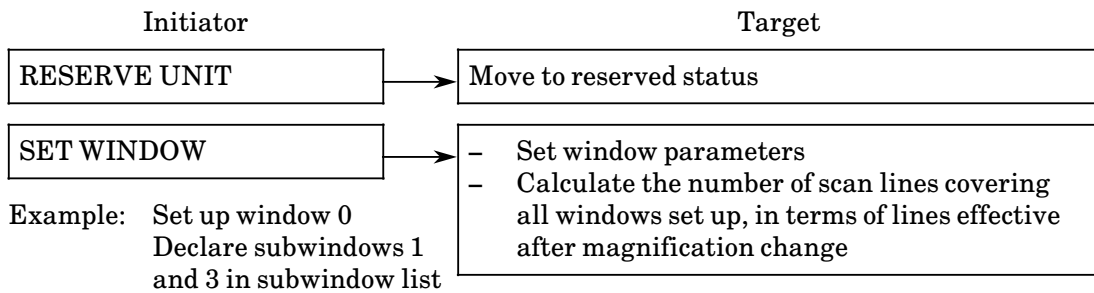

Document

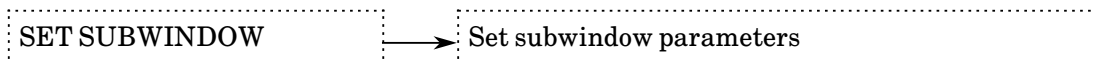
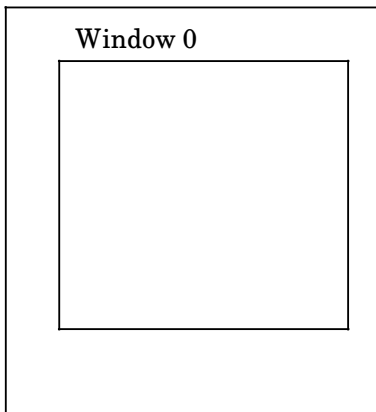

Example: Set up subwindows 1 and 3 (it is unnecessary to set subwindows)

Document

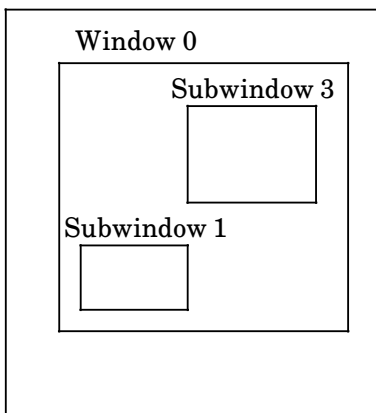

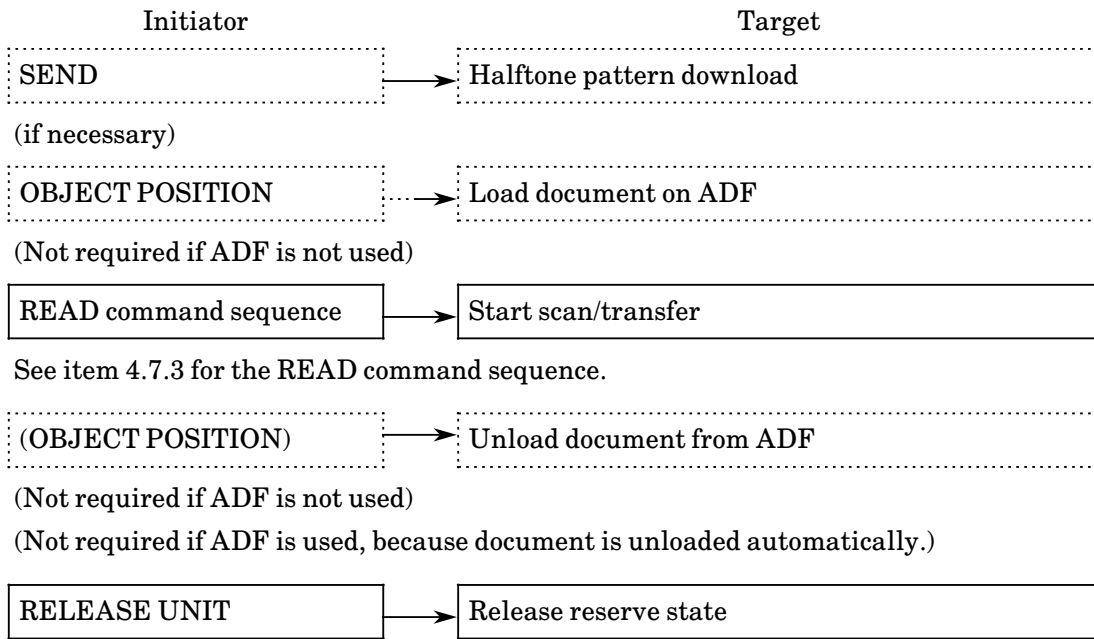

4.7.3 READ command sequence

4.7.3.1 Single READ (without CMP II option: disconnect disabled)

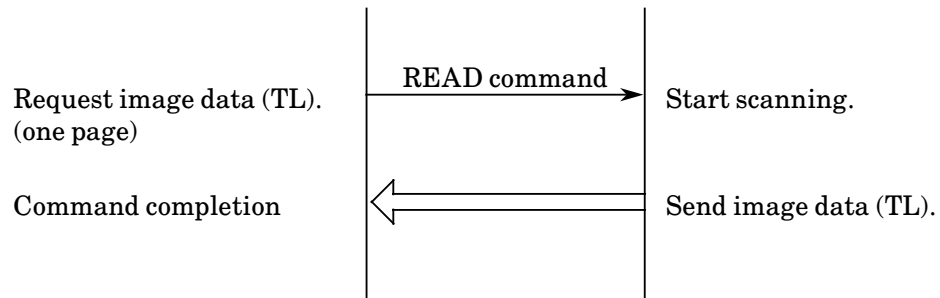

See Notes 1, 2, and 4.

4.7.3.2 Single READ (with CMP II option: disconnect disabled)

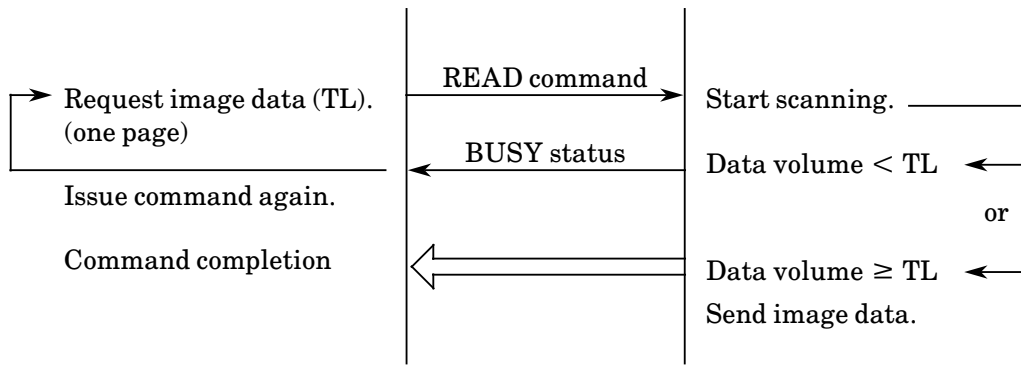

See Notes 1 and 2.

Data volume: Image data volume in the scanner at that time.

4.7.3.3 Single READ (with CMP II option: disconnect enabled)

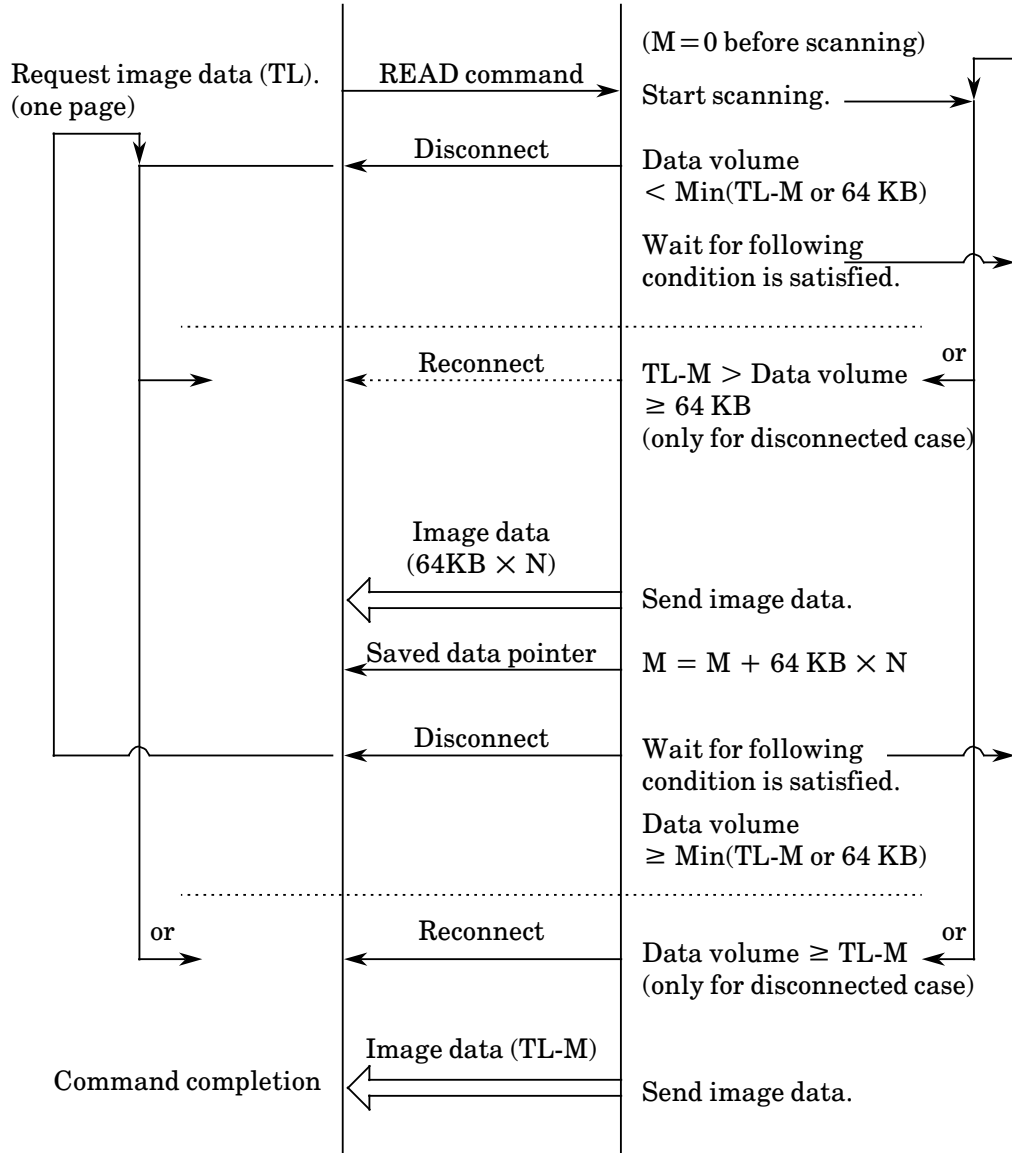

See Notes 1 and 2.

Min (TL-M or 64 KB): Either TL-M or 64 KB which is smaller.

4.7.3.4 Multiple READ (with CMP II option: disconnect disabled)

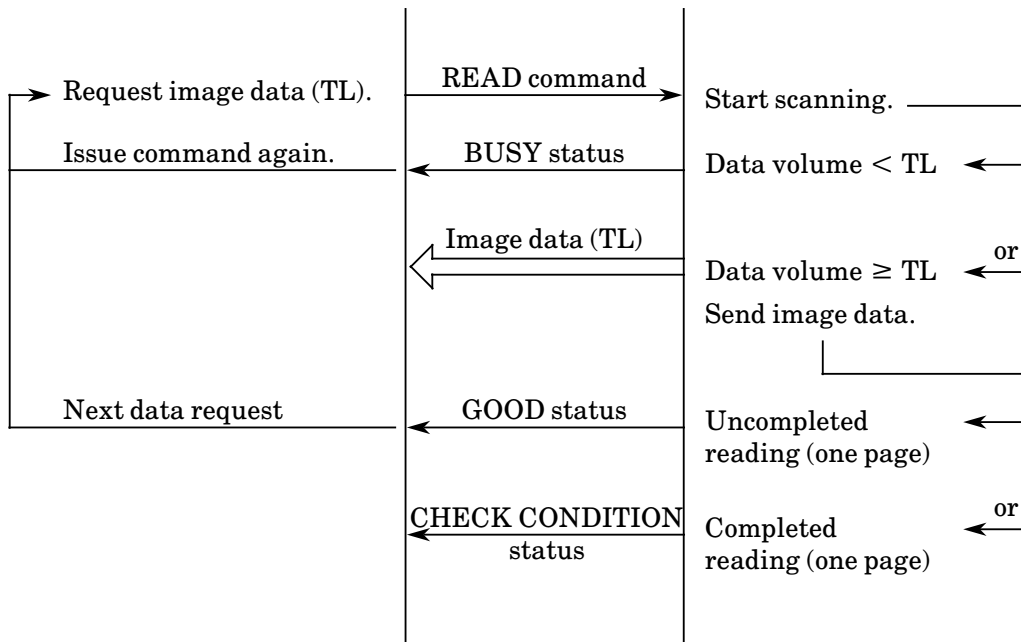

See Notes 1 and 2.

4.7.3.5 Multiple READ (with CMP II option: disconnect enabled)

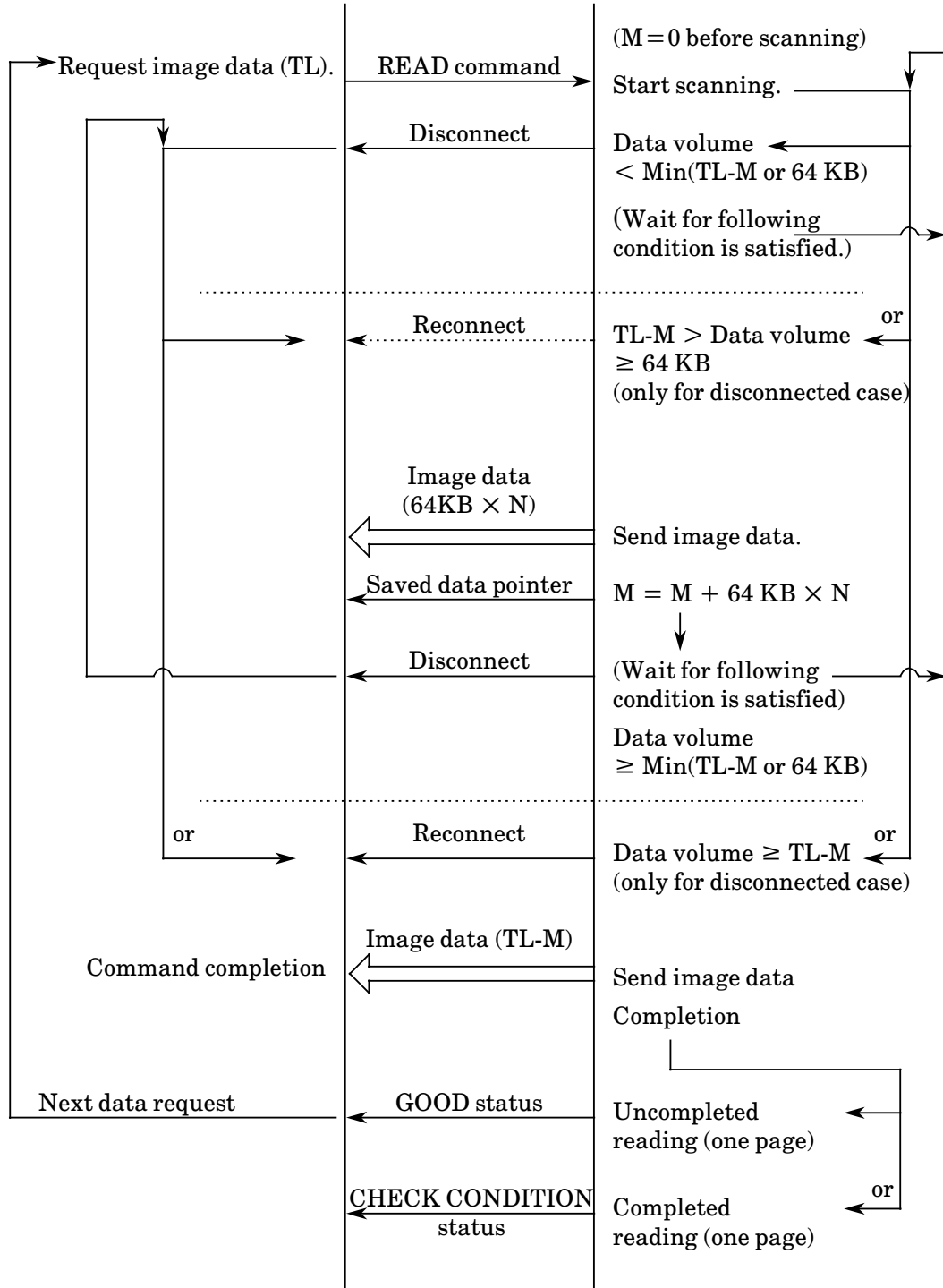

See Notes 1 and 2.

Notes:

1. If the requested transfer volume is not equal to the actual data volume, this scanner informs the initiator that the requested transfer amount is abnormal. This is done as the scanner returns the status 00001 (CHECK CONDITION) and creates the following sense data:

- ILI = 1
- INFORMATION = requested transfer amount (TL) – actual data amount

This status is usually sent to the last READ command of the sequence. (For commands other than the last READ, the GOOD status is reported.) If the data amount requested by the last READ command agrees with the last data amount left, the GOOD status is reported to the READ command, and the CHECK CONDITION status is reported to the next READ command.

2. In addition to the means described above in Note 1, the initiator has another means for ascertaining the completion of transfer of image data for one window. Specifically, the initiator issues the REQUEST SENSE command after each completion of the READ command, and if the sense data received in response is NO SENSE, the initiator checks the EOM bit in the sense data:

EOM bit = 0 . . . There is scan data yet to be transferred.

EOM bit = 1 . . . All scan data has been transferred.

However, issuing the REQUEST SENSE command after each completion of the READ command is not desirable in terms of processing efficiency.

3. Once all scan data has been transferred, the CHECK CONDITION status is always reported to the READ command that follows. Before attempting another read, first issue the SET WINDOW command.
4. When the CMP II option is not provided, image data for one window must be read in one READ command. If the data transfer rate is less than 1300 KB/S, a burst transfer error occurs. (Data overflow occurs because the scanner does not have enough memory.)
5. Enable or disable of disconnection is decided by bit 6 of the IDENTIFY message issued by the initiator at the READ command. The initiator that requires disconnection must set bit 6 of the IDENTIFY message. When the CMP II option is not provided, the disconnection is not performed even if bit 6 of the IDENTIFY message is set.

4.8 Status Transition of Logical Unit

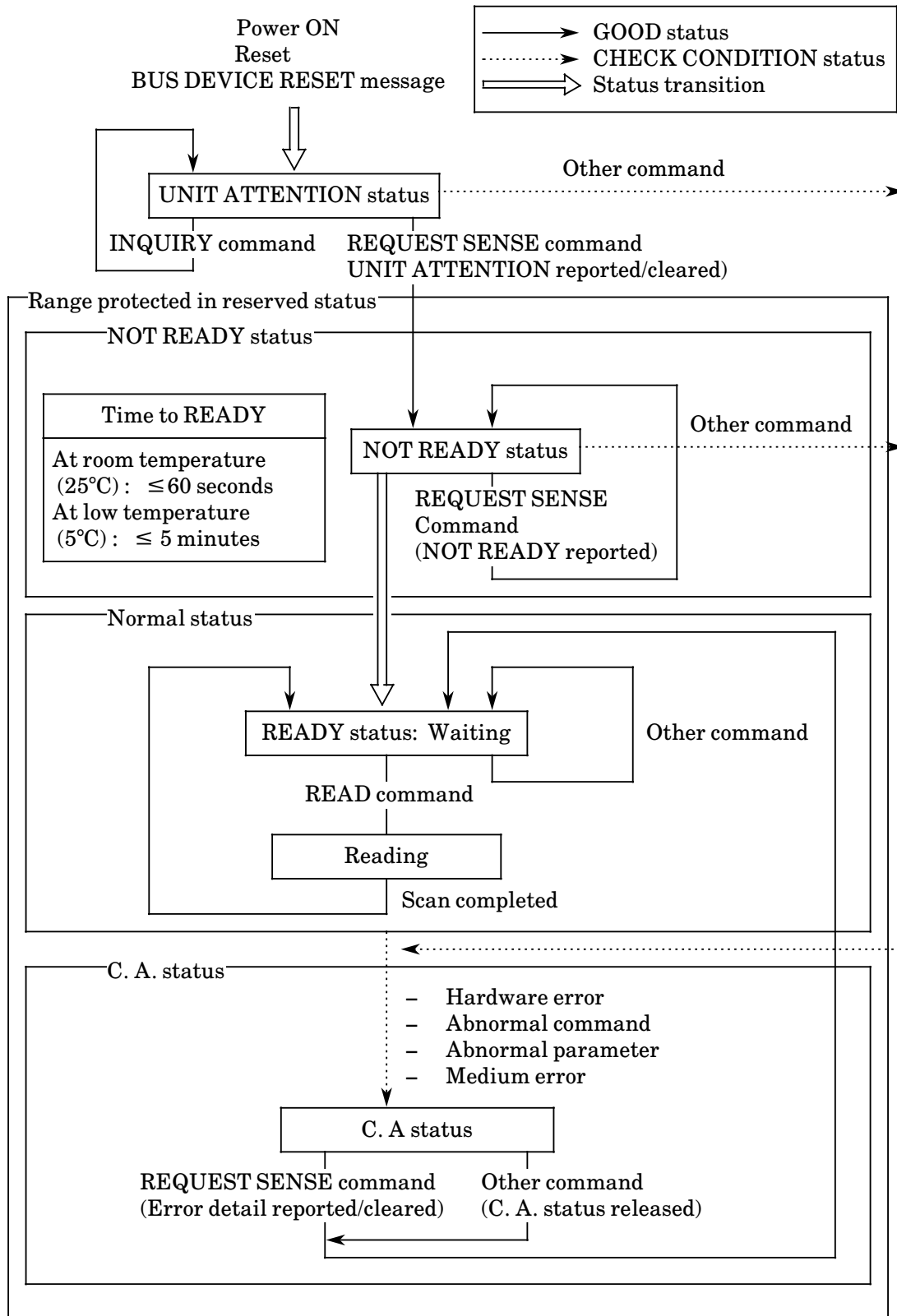

4.9 Error Table

The following table lists errors that may occur upon issue of each command.

	Sense key	0	2	3	4	5	6	B
	Content	NO SENSE	NOT READY	MEDIUM ERROR	HARDWARE ERROR	UNIT ATTENTION	ILLEGAL REQUEST	ABORTED COMMAND
SET SUBWINDOW		○	○	—	○	○	○	—
SET WINDOW		○	○	—	○	○	○	—
INQUIRY		○	—	—	—	—	(*1)	—
OBJECT POSITION		○	○	○	○	○	○	—
READ		○	○	—	○	○	○	○
RELEASE UNIT		○	○	—	○	○	○	—
REQUEST SENSE		○	—	—	—	—	(*1)	—
RESERVE UNIT		○	○	—	○	○	○	—
SEND		○	○	—	○	○	○	—
SEND DIAGNOSTIC		○	○	—	○	○	○	—
TEST UNIT READY		○	○	(*2)	○	○	○	—
MODE SELECT		○	○	—	○	○	○	—
MODE SENSE		○	○	—	○	○	○	—

*1 Error in command descriptor

*2 Jam of document being unloaded from ADF at power ON or reset time

4.10 Items for Specifying Window and Subwindow

The following table lists the items available for specifying a window and subwindow.

Image composition Item		00 Binary black and white		01				02 Gray scale
		Window	Sub- window	Dithering		Error diffusion		Window
				Window	Sub- window	Window	Sub- window	
X, Y resolution	○	×	○	×	○	×	○	
Upper left X, Y	○	○	○	○	○	○	○	
Width, length	○	○	○	○	○	○	○	
Threshold	○	○	△	△	△	△	□	
Brightness	△	△	○	○	○	○	□	
Contrast	○	○	○	○	○	○	○ *6	
Bit per pixel	01	01	01	01	01	01	08	
Halftone pattern	△	△	○	○	○	○	□	
Compression	○	×	○	×	○ *5	×	×	
Subwindow list	○	×	○	×	○	×	×	
Paper specification	○	×	○	×	○	×	○	
D T C I P C	DTC *1	○	×	○ *2	×	○ *2	×	□
	Outline emphasis	○	○	○	○	○	○	□
	Outline extraction	○ *3	○ *3	□	□	□	□	□
	Automatic separation	○ *4	○ *4	○ *4	○ *4	○ *4	○ *4	□
	Simplified DTC	○ *4	○ *4	□	□	□	□	□
	RIF (reverse image format)	○	○	○	○	○	○	○ *6
Mirror image	○	×	○	×	○	×	□	

○: Can be specified.

×: Cannot be specified.

△: Enabled if automatic separation is specified, otherwise ignored.

□: Can be specified but not enabled.

- *1: If DTC is specified, IPC can be specified but not enabled.
- *2: The image is not guaranteed.
- *3: Can be specified but not enabled if outline emphasis is also specified.
- *4: Can be specified but not enabled if outline extraction is also specified.
- *5: Not recommended because the compression is inefficient.
- *6: If any value other than contrast X'80' (00) and reverse image format are specified, the last two digits of the output data are 0.

APPENDIX A PAPER SPECIFICATIONS

- | |
|---|
| <p>A.1 Paper Size</p> <p>A.2 Paper Conditions</p> <p>A.3 Paper Limitations</p> <p>A.4 Grounding Color Area</p> <p>A.5 Job Separation Sheet</p> |
|---|

This appendix provides the readable paper specification when using the automatic document feeder (ADF).

When using the flatbed, any condition paper can be read. Only ground color specification (Section A.4) must be met.

A.1 Paper Size

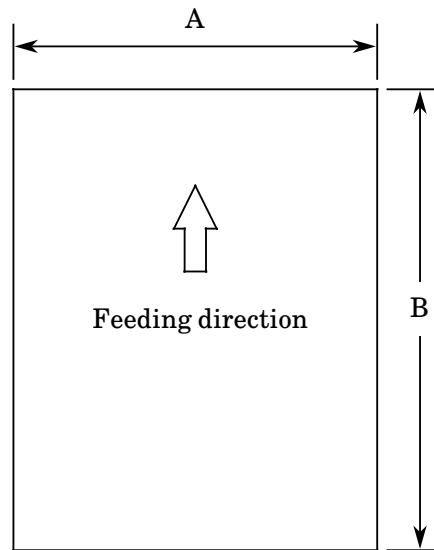

Maximum		Minimum	
A	B	A	B
297	432	148	105
		105	148

(Unit : mm)

Figure A.1 Paper size specification

A.2 Paper Conditions

A.2.1 Paper type

- Woodfree paper
- PPC paper; Specified by XEROX Corporation
- Pressure-fixing paper; specified by Fujitsu
- OCR paper

When using another paper, check that it is successfully fed by ADF before performing a scanning operation.

A.2.2 Ream weight

45 kg to 110 kg/ream

Note:

Ream weight is a weight of 1,000 pieces of paper whose size is 788 mm × 1,091 mm.

A.2.3 Paper quality

Following paper cannot be fed by ADF.

- ① Paper has clips or staples, etc.
- ② Ink, etc. is not dry.
- ③ Paper thickness is not constant. (like envelope)
- ④ Paper has large rumples or curl.
- ⑤ Paper has folds or tears.
- ⑥ Tracing paper
- ⑦ Coating paper
- ⑧ Paper size; smaller than A6 size, or larger than A3 width.
- ⑨ Other than paper; clothes, metal sheet, or OHP film.
- ⑩ Photographic paper
- ⑪ Paper has notches on its side.
- ⑫ Shape is other than square.

When reading the paper in items ③ to ⑫ use the flatbed.

A.2.4 ADF document feeder capacity

The number of pages that can be loaded into ADF chute depends on the paper size and ream weight. This information is shown in the following graph:

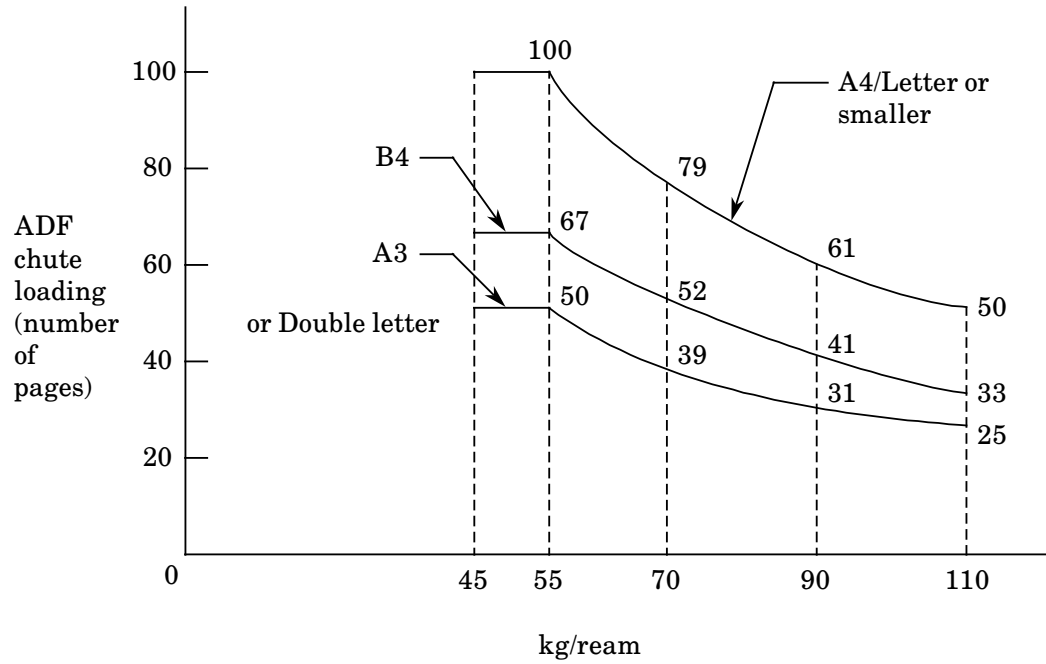

Ream weight conversion table

Country	Unit	Conversion						
		45	55	64.6	77.5	90	109.8	135
Japan	Kg/ream	45	55	64.6	77.5	90	109.8	135
US	lb	13.9	17	20	24	27.9	34	41.8
Europe	g/m ²	52	64	75	90	104	127	157

A.3.2 Reverse unprintable areas

If data is printed on the reverse of the page, confirm that no printing is in the areas shown shaded. A paper jam may result if printing exists in the shaded areas. Read data from these paper on the flatbed.

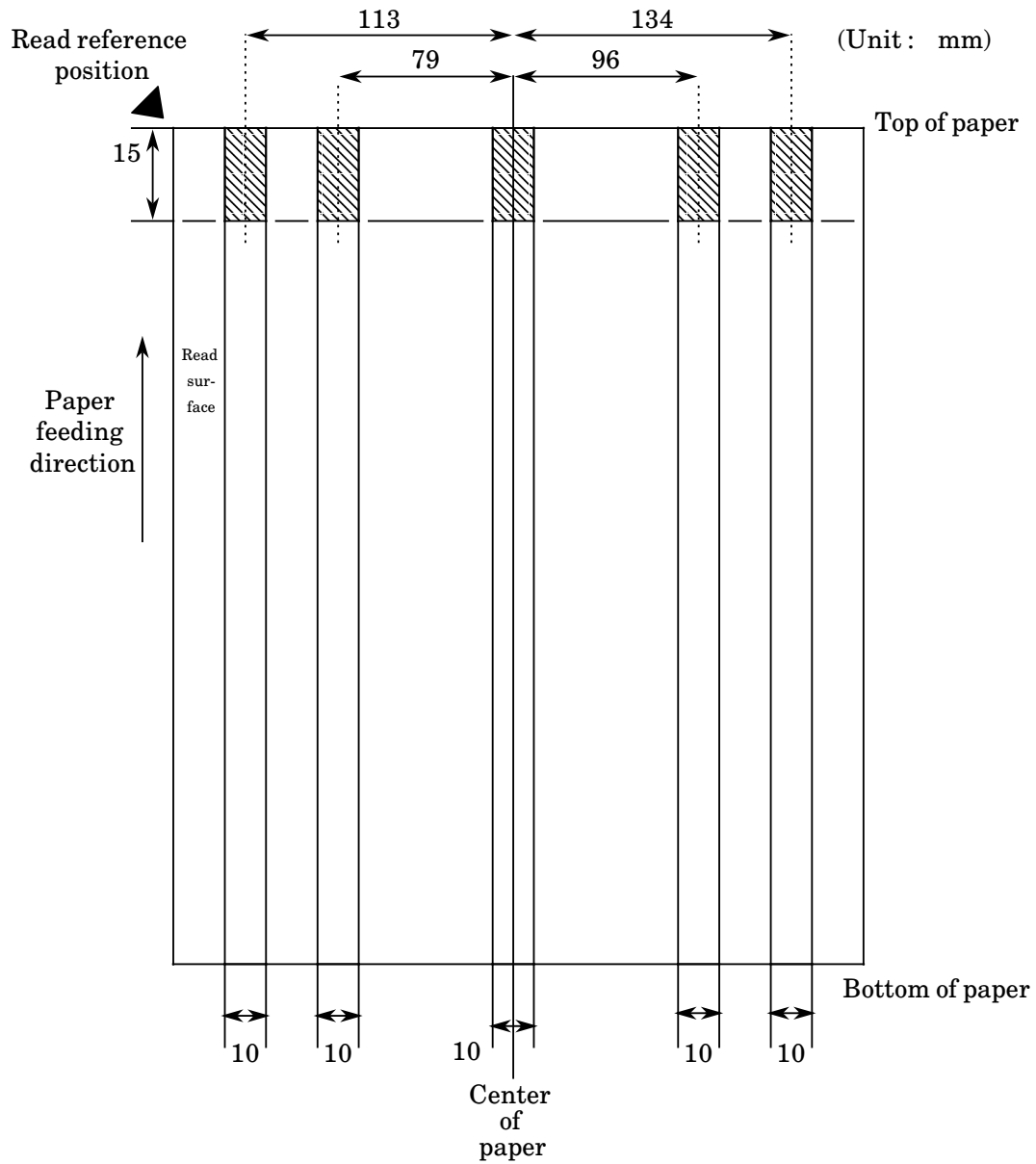

Figure A.3 Reverse unprintable areas

Note:

Figure A.3 shows the paper as viewed from the read surface.

A.4 Grounding Color Area

The color of the shaded area shown in Figure A.4 should be paper grounding color (white) or drop-out color. If not, select the “photograph” on the operator panel when reading.

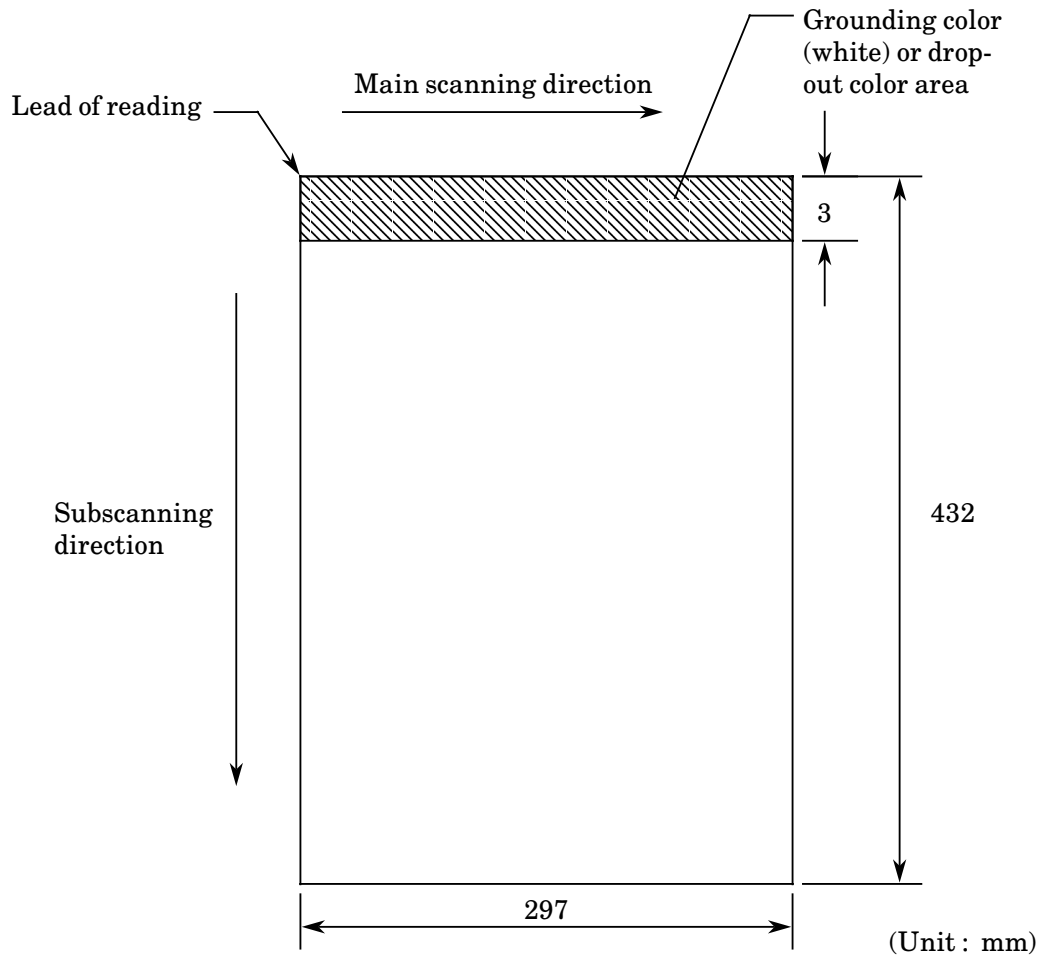
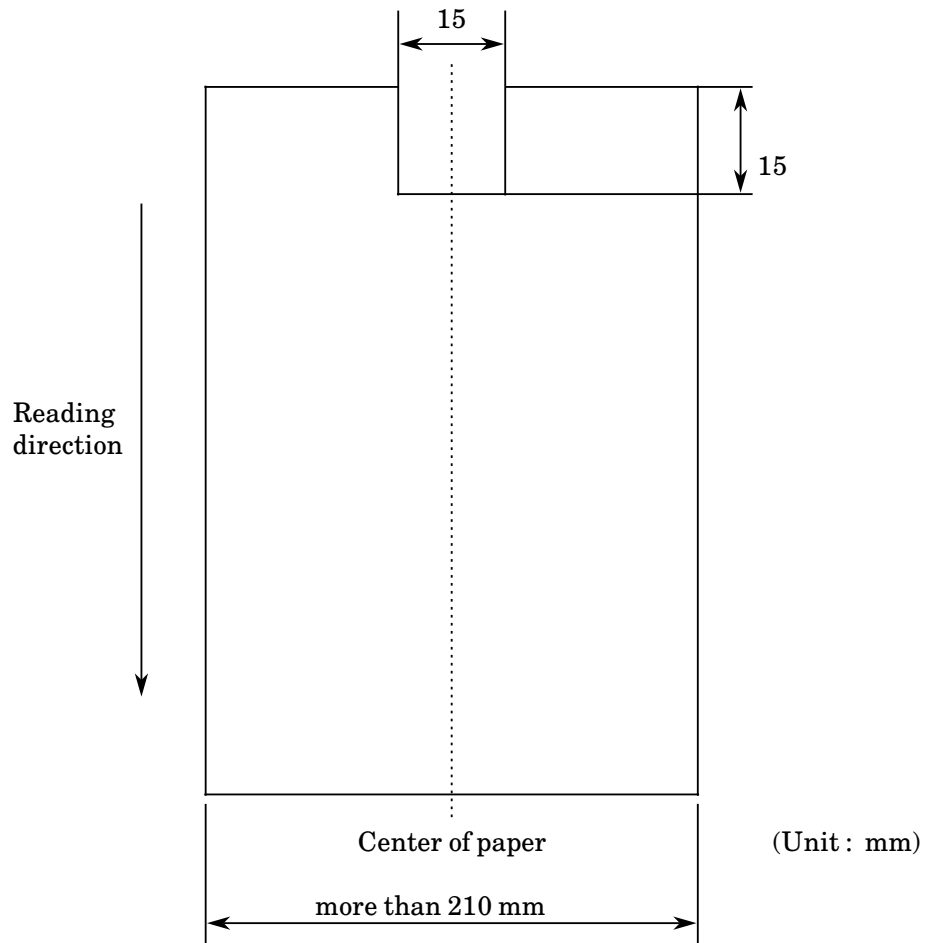

Figure A.4 Grounding color area

A.5 Job Separation Sheet

A.5.1 Shape

The following figure shows the basic shape of the paper.



A.5.2 Paper conditions

- (1) Appendixes A.2.1 and A.2.2 describe the conditions of use. The paper size must be A4 or larger (210 mm or wider).

APPENDIX B ADF SCANNING SPEED

This appendix provides information on the scanning speed of ADF.

Following table is the ADF scanning speed in the case of the temperature more than 15°C.

Unit: Sheets/min.

Scanning mode	Resolution	A4	A3	Letter
Line mode	400 dpi	20	15	21
	300 dpi	26	19	27
	240 dpi	31	23	32
	200 dpi	36	28	38
Photo mode	400 dpi	19	14	20
	300 dpi	25	19	26
	240 dpi	30	23	31
	200 dpi	35	27	36

Note:

The above is measured data.

This page is intentionally left blank.

APPENDIX C DROP-OUT COLOR

C.1 Print Density Measurement

C.2 Drop-out Color

C.1 Print Density Measurement

- (1) The spectrum band shown in Figure C.1 is used to measure print density.
- (2) The measurement must be made in one of the following ways :
 - a. A light source using fluorescent material G54 is used.
 - b. Macbeth PCS meter PCMII is used, which requires special filter.

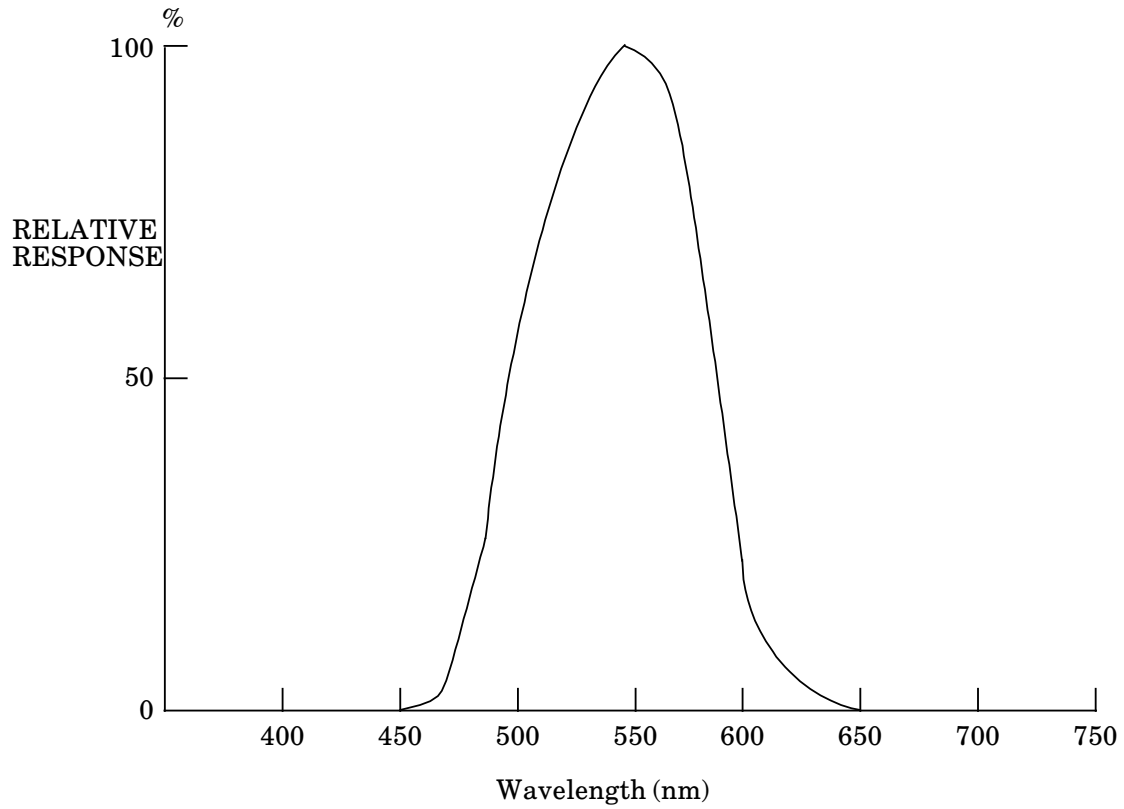

Figure C.1 Spectrum band

C.2 Drop-out Color

The drop-out color refers to a printing color visible to people but which cannot be recognized by the scanner. If characters other than the read characters are printed in the ground color area, they must be printed in the drop-out color.

Maximum PCS value of 0.14 or less and an average value of 0.10 or less.

APPENDIX D DIFFERENCES BETWEEN THE M3097G AND M3096G IMAGE SCANNERS

- | |
|---|
| <p>D.0 Preface</p> <p>D.1 Enhanced Functions and Functional Differences</p> <p>D.2 Supplement</p> |
|---|

D.0 Preface

This booklet provides information on interfacing when installing M3097G image scanners in addition to M3096G image scanners that are already supported.

D.1 Enhanced Functions and Functional Differences

This section explains the functions added to M3096G image scanners and the functional differences between M3096G and M3097G image scanners. This is useful when installing M3097G image scanners.

Table D.1.1 lists the added functions.

Table D.1.1 Added functions

No.	Function added	Section to be referenced	Remarks
1	The paper size detection function is added for an automatic document feeder (ADF). The applicable paper sizes are A3 or double-letter (DL), A4 or letter (LT), A5, B4, and B5.	D.1.1.1	Added
2	The job separation sheet detection function is added.	D.1.1.2	Added
3	Error diffusion is added to halftone processing.	D.1.1.3	Added
4	The contrast control function is added.	D.1.1.4	Added
5	Gamma correction is added.	D.1.1.5	Added
6	Dynamic threshold (equivalent to M3094A11) is enabled by the IPC II option (M3097E0191).	D.1.1.6	Added
7	The function for designating the period between lit-on and lit-off times on the fluorescent lamp is added.	D.1.1.7	Added
8	The sense code for a blown lamp fuse, and interlock switch open are added.	D.1.1.8	Added

Table D.1.2 lists the functional differences between two models.

Table D.1.2 Functional differences

No.	Differences	M3097G	M3096G
1	The required image data transmission speed is faster because the reading speed of the M3097G is twice that of the M3096G.	More than 1.3 MB/s	More than 625 KB/s
2	After turning on the scanner, the period between “Not ready” and “Ready” becomes longer.	25°C, 60s 5°C, 5min.	25°C, 30s 5°C, 3min.
3	Gray scale output	Not supported	Supported

D.1.1 Functions added

D.1.1.1 Paper size detection

- Restrictions
 - This function is operable only when using ADF. If this function is used for flat bed (FB) reading, the results from the scanner are not guaranteed.
 - If paper listed in OEM Manual Appendix A.3 is used, the results from the scanner are not guaranteed.
 - The applicable paper sizes are DL or A3, Lt or A4, A5, B4, and B5. The scanner cannot distinguish DL from A3, or LT from A4. If any other paper is used, the results from the scanner are not guaranteed.
 - When paper is loaded in the scanner for reading, the scanner assumes the orientation to which the paper is set as portrait.
 - Upon completion of reading (paper is ejected), the scanner can determine the orientation to which the paper is set (portrait or landscape).
- Recommended procedures for issuing commands

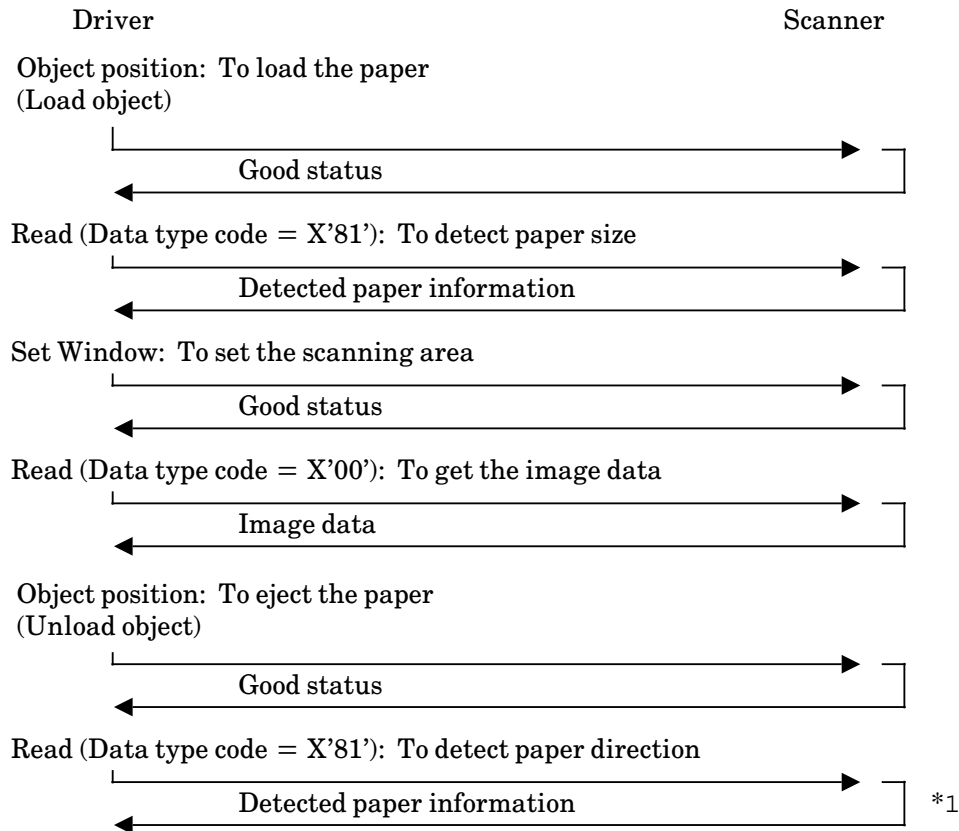

Figure D.1.1 Command sequence

- Description
 - Upon receiving the detected paper information from the read command (Data type code = X'81'), the driver or application software must specify the window area (Set window command Byte 6 to 15) and the paper size (Set window command Vender unique parameter byte 35) using the set window command.
 - The detected paper information is accessed with the read command (Data type code = X'81').
 - Once paper is fed by issuing the object position (Unload object) command, the direction to which paper is loaded (paper direction) is accessed with the read command (Data type code = X'81').

Format of detected paper information

Byte 0	Reserved
Byte 1	
Byte 2	Job separation sheet
Byte 3	Paper size
Byte 4	
Byte 5	Reserved
Byte 6	
Byte 7	

- Job separation sheet — Byte 2
 - X'80': Job separation sheet is detected.
 - X'00': Job separation sheet is not detected.

- Paper size — Byte 3

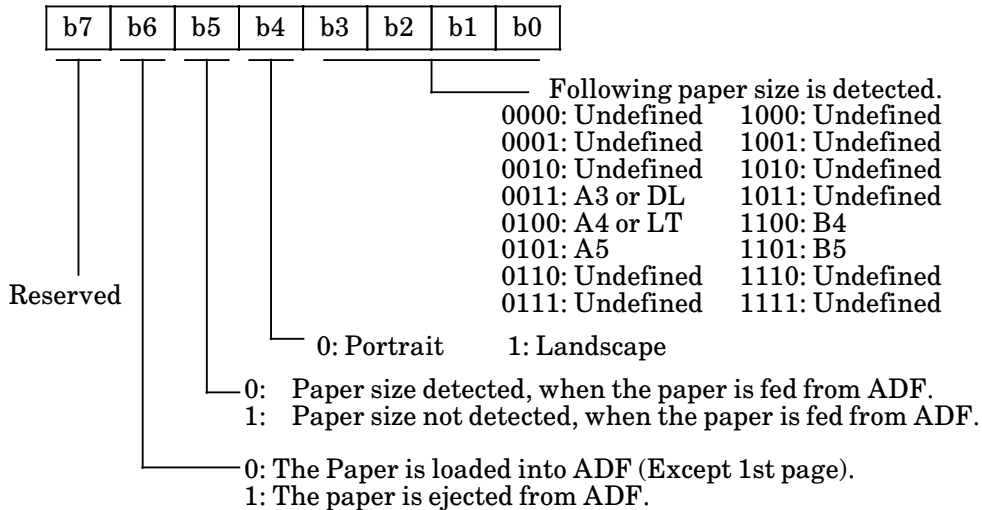

Note:

Bits 4, 5, and 6 are effective only when image data has been read. An “*1” in Figure 1.1.1 shows the effective timing.

D.1.1.2 Job separation sheet detection

- Notes on using this function
 - This function must be used to separate different jobs.
 - For the sheet format, refer to *OEM Manual* Appendix A.5.
- Restrictions
 - The sheet format must be in accordance with OEM Manual Appendix A.5.
 - The sheet quality must be in accordance with OEM Manual Appendix A.2.
- Recommended procedures for issuing the command
 - Issue the command by executing one of the following procedures:

Case 1

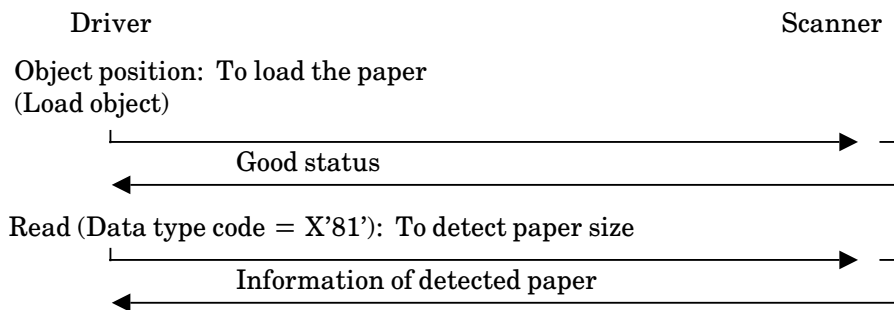

- Explanation (Case 1)
 - Whether a job separation sheet is detected is notified to Byte 2 of detected paper information.
 - Issue the object position (Unload object) to feed the job separation sheet.

Case 2

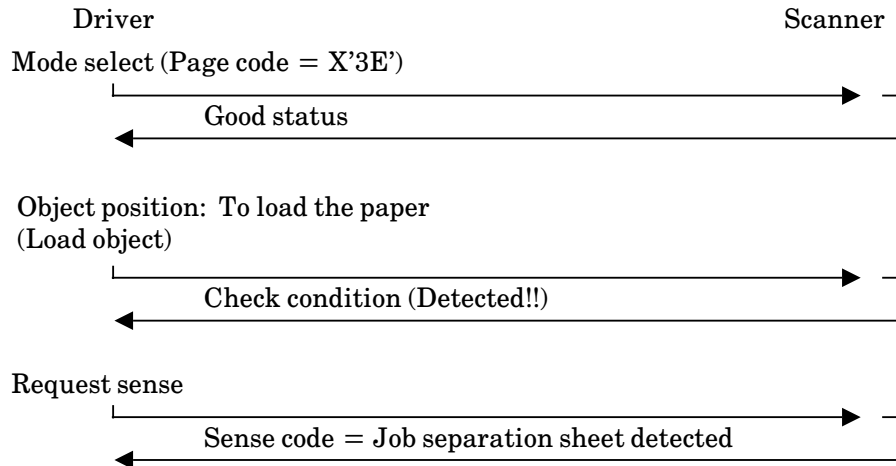

- Explanation (Case 2)
 - When the job separation sheet is detected, use the mode select command to post the check condition.

Format of Page Code X'3E'

Byte 0	Reserved	Page code = X'3E'
Byte 1	Parameter length = X'06'	
Byte 2	Parameter	
Byte 3	_____	
Byte 4	_____	
Byte 5	Reserved	_____
Byte 6	_____	
Byte 7	_____	

- Parameter — Byte 2
 - X'80': Posts the Check condition when a job separation sheet is detected.
 - X'00': Does not post the Check condition when a job separation sheet is detected.
- Sense code
 - Sense Key = 3, Additional sense code = X'80', Qualifier = X'04'

- Supplement (case 2)
 - Follow the procedures below to eject this sheet upon detecting the job separation sheet.

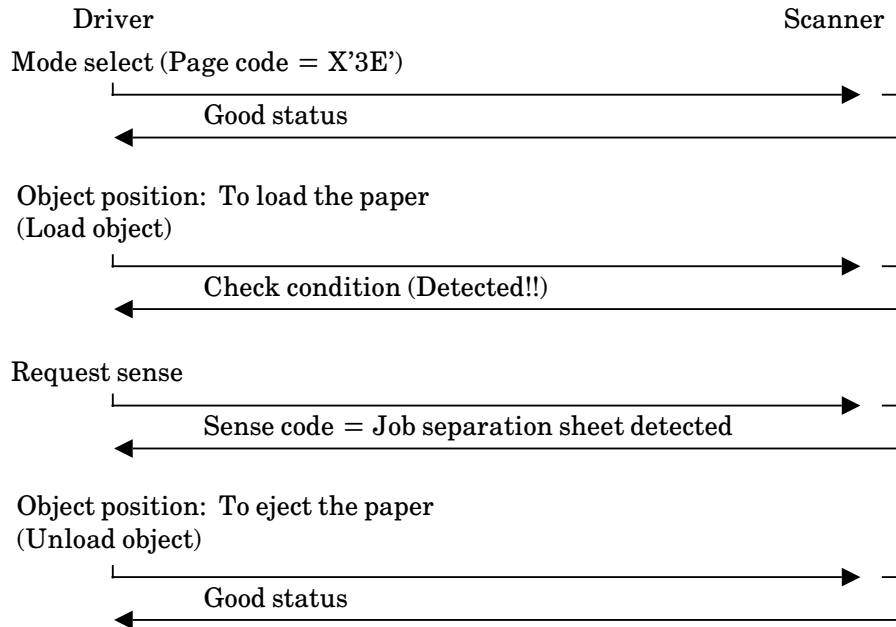

- Follow the procedures below to read this sheet upon detecting the job separation sheet.

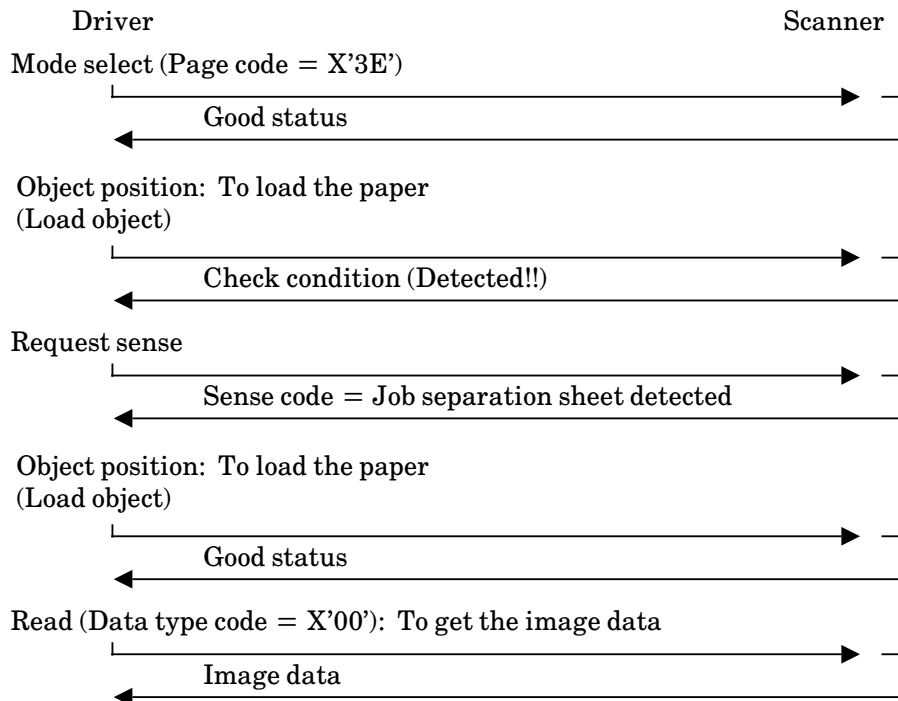

D.1.1.3 Error diffusion

- The table below lists the details of the error diffusion functions for the set window parameter.

Byte to be changed	Name	M3096G	M3097G
Byte 1B	Halftone type	X'00': Default (Dither) X'01': Reserved X'02': Reserved X'03' to X'FF' Reserved	X'00': Default (Dither) X'01': Dither X'02': Error diffusion X'03' to X'FF' Reserved

D.1.1.4 Contrast

- The table below lists the detail of the contrast function for the set window parameter.

Byte to be changed	Name	M3096G	M3097G
Byte 18	Contrast	X'00': Default (Normal) X'01' to X'FF' Reserved	X'00': Default (Normal) X'01': Mostly soft X'08': Normal X'FF': Mostly sharp

D.1.1.5 Gamma correction

- The table below lists the detail of the gamma correction for the set window parameter.

Byte to be changed	Name	M3096G	M3097G
Byte 29	γ Pattern Number	X'00': Default (Normal) X'01' to X'FF' Reserved	X'00': Default (Normal) X'01': Normal X'02': Soft X'03': Sharp X'04' to X'7F': Reserved X'80': X'81': X'82': X'83': X'84': X'85' to X'FF': Reserved

} Down load pattern

D.1.1.6 Dynamic threshold

- The change was made to the bytes in the set window parameter as follows:
 - Byte 3E
 - M3096G: X'00': Default; Simplified DTC, if IPC option is selected.
X'01' to X'FF' Reserved
 - M3097G: DTC SELECTION BYTE

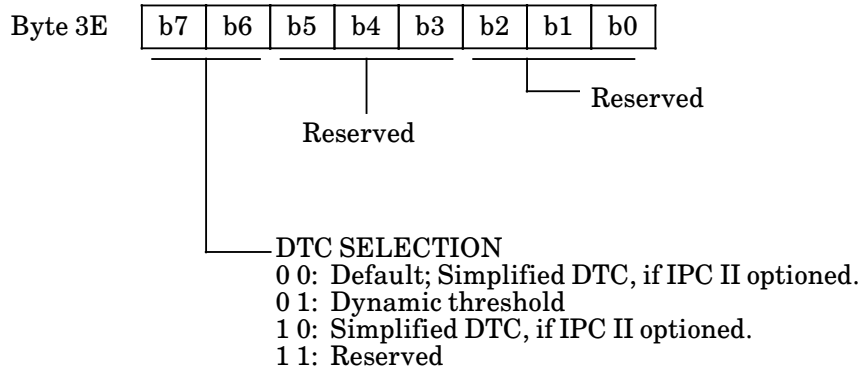

Example: X'00' is “Default; Simplified DTC, if IPC II option is selected”.

- Byte 2F
 - M3096G: Reserved
 - M3097G: The definitions of the byte are the same as those of M3097G control register #3. For further details, refer to *OEM Manual 50FH5037E*.
Restrictions: This byte is effective only when byte 3E is X'40'.
- Byte 30
 - M3096G: Reserved
 - M3097G: The definitions of the byte are the same as those of M3097E control register #4. For further details, refer to *OEM Manual 50FH5037E*.
Restrictions: This byte is effective only when byte 3E is X'40'.
- How to specify the parameter
 - When Simplified DTC is used:
Specified as “Byte 17 (threshold)=X'00', Byte 3E (DTC SELECTION)=X'00' or X'80'.
 - When Dynamic threshold is used:
Specify as “Byte 17=X'00', Byte 3E=X'40', Byte 2F/30”.

D.1.1.7 Lamp timer function

- Functions
 - This function specifies how long the lamp will stay on.
 - This must be specified with Mode select (Page code = X'3D').

Format of Page Code X'3D'

Byte 0	Reserved	Page code = X'3D'
Byte 1	Parameter length = X'06'	
Byte 2	Parameter	
Byte 3		
Byte 4		
Byte 5	Reserved	
Byte 6		
Byte 7		

- Parameter — Byte 2
 - X'00': The default value is 60 seconds for this scanner.
 - X'01' to X'FF': Specifiable between 1 to 255 seconds (X'FF')

D.1.1.8 Added sense code

Following sense code are added.

The blown lamp fuse;

“Sense key = X'04', Add.sense code = X'80', Add.sense qualifier = X'03”.

Interlock switch is opened;

“Sense key = X'02', Add.sense code = X'80', Add.sense qualifier = X'01”.

D.2 Supplement

This section explains the corrections to be made in the M3096G OEM Manual.

D.2.1 Unified terminology

The table below lists the terminology to be modified.

No.	M3096G	M3097G	Remarks
1	Binary monochrome	Line art	Set window parameter byte 19
2	Dithered monochrome	Halftone	
3	Multi-bit	Gray scale	
4	Outline	Outline extraction	Set window parameter byte 2A
5	Emphasis	Image emphasis	Set window parameter byte 2B
6	Mixed scan	Automatic separation	Set window parameter byte 2C
7	Mirroring	Mirror image	Set window parameter byte 2d

These modifications will be applied to M3096G OEM Manual later.





D.2.2 Corrections

The table below lists the items missing from the M3096G OEM Manual.

- Byte 32: White level follower mode.

Value (Hex)	Meaning						
00	Default. White level follower depends on the image composition. <table border="1"><thead><tr><th>Image composition</th><th>White level follower</th></tr></thead><tbody><tr><td>Line art (X'00')</td><td>Enable (line mode)</td></tr><tr><td>Halftone (X'01')</td><td>Disable(photo mode)</td></tr></tbody></table>	Image composition	White level follower	Line art (X'00')	Enable (line mode)	Halftone (X'01')	Disable(photo mode)
Image composition	White level follower						
Line art (X'00')	Enable (line mode)						
Halftone (X'01')	Disable(photo mode)						
01 to 7F	Reserved						
80	Enables white level follower. (line mode)						
81 to BF	Reserved						
C0	Disable white level follower. (photo mode)						
C1 to FF	Reserved						

- Byte2E: Variance rate for simplified DTC.

Value (Hex)	Meaning
00	Default
01 to 1F	Variance rate is small
20 to 3F	Variance rate is 
40 to 5F	Variance rate is 
60 to 7F	Variance rate is 
80 to 9F	Variance rate is normal
A0 to BF	Variance rate is 
C0 to DF	Variance rate is 
E0 to FF	Variance rate is large

D.2.3 Notes on compatibility

D.2.3.1 Resolution

- M3096G: With installation of the IPC option, resolution is specifiable as a number from 100 dpi to 1600 dpi in units of 4 dpi. If the specified value cannot be divided by 4, the fractional part (remainder) is ignored.

Example: If the specified value is “203 dpi”, processing is executed at 200 dpi for the M3096G scanner.

- M3097G: With installation of the IPC II option, resolution is specifiable as a number from 50 dpi to 1600 dpi in units of one dpi.

- Note:

If the specified value in the installation of the M3096G cannot be divided by 4, the value must be specified as a number that can be divided by 4 when installing the M3097G scanner.

- Supplement

When neither the IPC nor IPC II option is installed in the M3096G or M3097G scanner, only 200 dpi, 240 dpi, 300 dpi, or 400 dpi can be specified.

D.2.3.2 Brightness

- M3096G: The brightness is specifiable in eight steps.
- M3097G: The brightness is specifiable in 255 steps.
- Note:

It is recommended to specify the values below to allow specification in eight steps for both the M3096G and M3097G scanners.

01 (Brighter), 20, 40, 60, 80 (Medium), A0, C0, E0 (Darker)

D.2.3.3 Threshold

- M3096G: The value of threshold is specifiable in 64 steps. If the specified value cannot be divided by 4, the fractional part (remainder) is ignored.
- M3097G: The value of brightness is specifiable in 255 steps.
- Note:

It is recommended to specify the values below to allow specification in 64 steps for both the M3096G and M3097G scanners.

01 (Brighter), 04, 08, ... 80 (Medium),, FC (Darker)

D.2.3.4 Downloaded dither pattern and Brightness

- M3096G: To use the downloaded dither pattern in the M3096G scanner, specify “0” as Brightness.
- M3097G: If the downloaded dither pattern is used in the M3097G scanner, the value of Brightness is specifiable in 255 steps.

D.2.3.5 Simplified DTC

- M3096G: If the threshold value in the Set window parameter is 0, the Simplified DTC function is operable. However, this is available only if the IPC option has been installed. This function allows specification of the Variance rate.

- M3097G: If the threshold value in the Set window parameter is 0 and the value of the DTC SELECTION byte is specified as a number between X'00' or X'80', the Simplified DTC function is operable. However, this is available only if the IPC II option has been installed. This function allows specification of the Variance rate.

Comments concerning this manual can be directed to one of the following addresses:

FUJITSU LIMITED
International Marketing
Marunouchi 1-6-1, Chiyoda-ku, Tokyo 100 JAPAN
TEL: 03-216-3211
FAX: 03-213-7174, 03-216-9353
TLX: J22833
Cable: "FUJITSU LIMITED TOKYO"

FUJITSU COMPUTER PRODUCTS OF AMERICA, INC.
2904 Orchard Parkway, San Jose, California 95134-2009, U.S.A.
TEL: 1-408-432-6333
FAX: 1-408-432-3908

FUJITSU CANADA INC.
2800 Matheson Blvd. East, Mississauga, Toronto,
Ontario L4W 4X5, CANADA
TEL: 1-416-673-8666
FAX: 1-416-673-8677
TLX: 968132

FUJITSU EUROPE LIMITED
2, Longwalk Road, Stockley Park,
Uxbridge, Middlesex UB11 1AB, ENGLAND
TEL: 44-81-573-4444
FAX: 44-81-573-2643
TLX: 263871FEL SP G

FUJITSU DEUTSCHLAND GmbH
Frankfurter Ring 211, 8000 München 40, F.R. GERMANY
TEL: 49-89-323780
FAX: 49-89-32378100
TTX: 897106 FDG D

FUJITSU NORDIC AB
Torggatan 8, 171 54, Solna, SWEDEN
TEL: 46-8-764-76-90
FAX: 46-8-28-03-45
TLX: 13411 FNAB S

FUJITSU ITALIA S.p.A.
Via Melchiorre Gioia, 8, 20124 Milano, ITALY
TEL: 39-2-6572741
FAX: 39-2-6572257
TLX: 350142 FJITLY I

FUJITSU FRANCE S. A.
17, rue Olof Palme-94006 Créteil cedex, FRANCE
TEL: 33-1-43-99-40-00
FAX: 33-1-43-99-07-00
TLX: 262661

FUJITSU AUSTRALIA LIMITED
475 Victoria Avenue, Chatswood, N.S.W. 2067, AUSTRALIA
TEL: 61-2-410-4555
FAX: 61-2-411-8603, 8362
TLX: 25233

FUJITSU HONG KONG LIMITED
R.M. 1831, Sun Hung Kai Centre, 30 Harbour Road, HONG KONG
TEL: 852-5-8915780
FAX: 852-5-742917
TLX: 62667

FUJITSU