

ZANUSSI

**GLASKERAMIKKOCHFELD
GLASKERAMIKHÄLL
GLASKERAMISK KOGESEKTION
KERAAMINEN KEITTOTASO
TABLE VITROCÉRAMIQUE
KERAMISCH KOOKPLATEAU
CERAMIC BUILT-IN HOB**

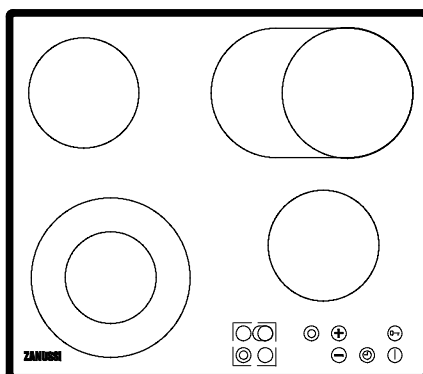

ZKT 662 LN

**GEBRAUCHSANWEISUNG
BRUKSANVISNING
BRUGSANVISNING
KÄYTTÖ-JA ASENNUSOHJE
NOTICE D'UTILISATION
GEBRUIKSAANWIJZING
OPERATING INSTRUCTIONS**

Dear Customer

GB

Congratulations on your purchase of an **Zanussi** glass-ceramic hob. You have thereby chosen in favour of quality and durability.

These operating operations will help you become acquainted with your ceramic hob step-by-step, and enable you to take optimum advantage of all its features. You should, however, carefully read through the section «**Important Safety Information**» before putting the appliance into service for the first time.

We recommend that the operating instructions be kept near the unit for immediate reference should problems arise.



This appliance conforms
with EC-Directive 73/23/EEC,
90/683/EEC, 89/336/EEC, 93/68/EEC

Content

Important Safety Information	80	Cleaning and care	95
For the user		Cleaning after each use	95
The Built-in Ceramic Hob	82	Stain removal	95
Description of the hob	82	Special problems	95
Touch Controls	82	What to do when	96
Before the first use	83	First aid for faults	96
Cleaning for the first time	83	For the installer	
Heating up for the first time	83	Technical Data	97
The Cooking Zone	83	Unpacking and control	98
Ceramic cooking surface	83	Installation Instructions	98
Touch Controls	83	Installing into a kitchen worksurface ...	98
Residual heat indicator	84	Installation dimensions	99
Operation	84	Installation	99
Switching the appliance on	84	Removing the glass-ceramic hob	100
Switching on the cooking zones	84	Electrical connections	100
Selecting the power level	85		
Switching off the cooking zones	85		
Switching off the hob	86		
Over-cooking protection	86		
Safety cut-out	86		
Dual-ring cooking zone	87		
Selecting the dual-ring cooking zone ..	87		
Switching the dual-ring cooking zone off	87		
Safety lock - barring the appliance or the cooking zones	88		
Locking the appliance	88		
Locking (barring) the individual cooking zones	88		
Boost facility	89		
Selecting the boost facility	89		
Indicating the selected power level	90		
Changing the Power Level during the Boost facility	90		
Take advantage of the residual heat by the Boost facility	90		
Switching off the Boost facility	90		
The Timer Function	91		
Switching the Timer function on	91		
Changing the set cooking time	91		
Calling up the current cooking time	91		
Switching the Timer function off	92		
The Timer Function as an Egg-Timer	93		
Setting the egg timer	93		
Switching the egg timer off	93		
The right cooking utensils	94		
Energy consumption	94		
Saucepans and frying pans	94		

Important Safety Information

Read the operating instructions carefully before using the unit. Please pay particular attention to the safety information, which is designated with .

This will avoid damage, both to persons and the unit. **Keep the operating instructions in a safe place,** and hand them to the next user if necessary.

The unit must only be used in the household and for its intended purpose. It conforms with international safety regulations and quality standards. The safety features incorporated do not always cover all the possible risks of accident.

Electrical safety

This appliance must only be installed by a qualified electrician. For reasons of electrical safety, built-in appliances must only be installed into the standard, matching mounting cabinet or worktop.

Only use the hob when it has been fully installed. This will prevent you from coming into contact with current-carrying parts.

Also follow the information given in the accompanying Instructions for Use and for Installation

Damaged hobs with cracks or breakages in the glass ceramic surface must not be connected to the mains.

For reasons of safety, repairs to the appliance, and in particular to the current-carrying components, must only be carried out by qualified electricians or trained Customer Service technicians. Otherwise, considerable danger could result for the user. In case of malfunction, contact our Customer Service department directly.

If the glass-ceramic hob is to be used in the vicinity of a radio, TV or other transmitting device, it must first be clarified whether this could affect its operation.

The appliance is only disconnected from the mains when the fuse is turned off or the mains connection is interrupted.

Use and Operation

Prevent small children from touching the glass-ceramic top when in use. As a rule, they should be kept away from both the hob and from pots and pans. Children can also burn themselves by pulling pans or pots off the hob.

The cooking zones heat up quickly when they are turned on. Only turn them on if you have placed a saucepan on the cooking area.

Exercise care when working with a hot hob, or hot pots or pans. There is always a **danger of being burned**

The residual heat indicator integrated in the electronics tells you whether a cooking zone is still hot.

In case a pan/pot is left on the cooking zone the residual heat indicator can switch off though is the cooking zone still hot from the pan with hot contents.

In the event of a power failure, all settings and displays will be lost. Be careful, because hot cooking zones will no longer be indicated by the residual heat indicator.

If you use a socket close to the hob, take care that the cable of the appliance does not touch the hot surface of the hob.

Do not store any temperature-sensitive or inflammable materials (such as detergents, spray cans) in the drawers or the cupboards underneath the built-in hob.

The cooking surface must not be used as a storage or working area.

Attention! Never look directly into the light from the halogen cooking zone.

Never leave the hob unattended when working with oils and fats, due to the danger of fire.

Never use plastic or aluminium foil dishes on the hob. They melt at high temperatures, and can damage the glass-ceramic plate.

Neither sugar (solid or liquid) nor plastic should be allowed to come into contact with the hot surface of the hob.

When the plate cools down, cracks or breakages could occur in the glass-ceramic plate. If sugar or plastic should accidentally come into contact with the hot hob, the latter must not be switched off for any reason, but the sugar or plastic remnants must be removed with a scraper while still warm. Protect your hands from burns.

To avoid scratching the surface of the glass-ceramic hob, only use pots and pans with flat bases and without rough edges.

The ceramic hob surface is resistant to extreme temperatures. Neither cold nor heat can harm it. Avoid dropping anything on the hob. Point impacts, e.g. by dropping a salt shaker, can cause fissures and cracks.

A defective hob surface could allow food which has boiled over to penetrate through the hob, and contact the electrical parts.

If any cracks appear on the hob surface, the hob must be switched off immediately. Disconnect the appliance from the mains and inform the service department.

Follow the Care and Cleaning instructions for the glass-ceramic surface. We will accept no liability for improper use.

After use, check that the appliance is switched off.

Cleaning

No heating element should be switched on while cleaning. Ensure that the cooking areas have cooled down sufficiently (wait until the residual heat lamp goes out) so that there is no danger of burning.

Always keep the glass-ceramic surface clean.

For reasons of electrical safety, steam and high-pressure cleaning devices must not be used for cleaning the hob.

Disposal



Please dispose of packing material and any old appliances according to the relevant regulations. Please observe national and regional regulations and the material designation (material separation, waste collection, material disposal points).



Stop!

This symbol indicates a warning about serious danger of injury. It must always be observed.



Caution!

This symbol indicates information which, if not observed, could lead to danger to persons and/or significant damage to material. This safety information must always be observed.



Note

This symbol indicates information with important details concerning use. Non-observance could lead to faults.

The Built-in Ceramic Hob

Description of the hob

- 1 Rapid Cooking zone (double-ring)
highlight Ø 210/120 mm 2200/750 W
- 2 Rapid Cooking zone
highlight Ø 145 mm 1200 W
- 3 Rapid Cooking zone (double-ring)
highlight Ø 170x265 mm 1500/2400 W
- 4 Rapid Cooking zone
halolight Ø 145 mm 1200 W
- 5 Touch responsive controls

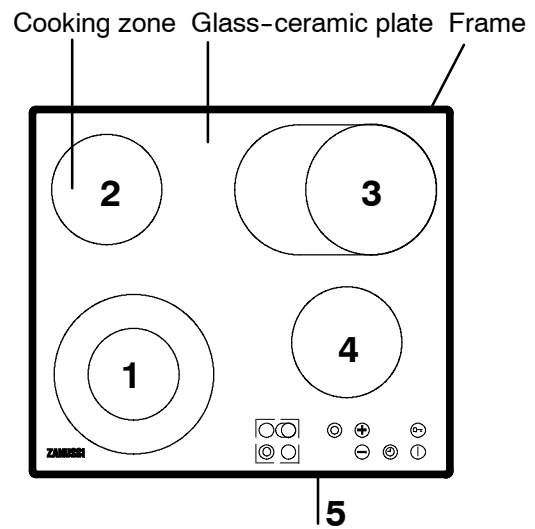

Touch Controls

- 1. Power-On-Taste (Steuerung AUS/EIN)
- 2. Kochfeld-Taste (EIN/AUS)
- 3. Anzeige Leistungsstufe bzw. Restwärme
- 4. Minus-Taste
- 5. Plus-Taste
- 6. Zweikreis-Taste (EIN/AUS)
- 7. Timertaste
- 8. Timeranzeige
- 9. Verriegelungstaste
- 10. Kontrollampe Zweikreis-Zuschaltung
- 11. Kontrollampe Timerfunktion
- 12. Kontrollampe Verriegelung (Steuerung)
- 13. Dezimalpunkt in der Leistungsstufenanzeige
Leuchtet: Kochzone bedienbar
Leuchtet nicht: Kochzone gesperrt

Before the first use

Cleaning for the first time

The cooking surface should be cleaned before use to remove any traces of the production process.

Wash the glass-ceramic surface and frame with hot water and rinsing agent, and wipe dry.

Heating up for the first time

To check the cooking zones, briefly switch each one on.

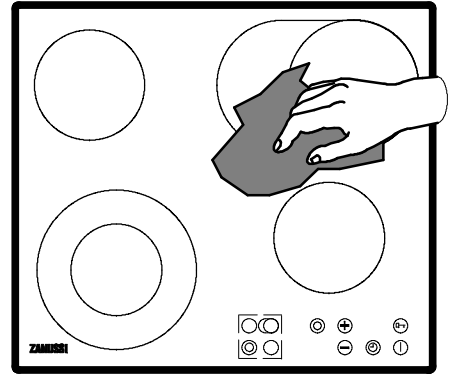

The Cooking Zone

Ceramic cooking surface

The cooking surface is made of ceramic glass. The surface is pore-free and also insensitive to rapid changes in temperature. Pots can therefore be moved from a hot to a cold zone.

When switching on the cooking zone there may be a brief humming sound from the heaters. This is normal and disappears when the cooking zone has warmed up.

 Keep all objects and materials which can melt away from the cooking surface, e.g. plastics, aluminium foil.

Take care when preparing food or drinks containing sugar. If anything of this nature accidentally comes into contact with the ceramic surface, it must be scraped off **immediately while still hot** and wiped away cleanly to avoid damage to the surface.

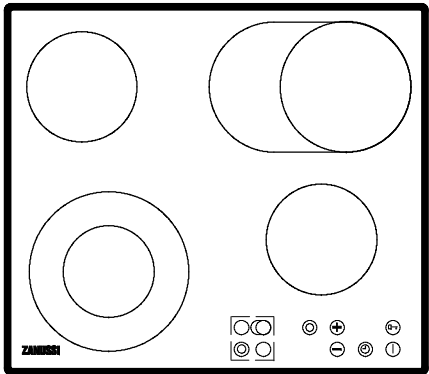

Touch Controls

The hob is operated by the touch controls located at the front, each of which has its own display.

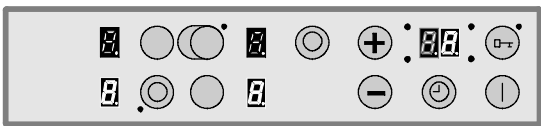

Residual heat indicator

An "H" will light up in the power level indicator if the temperature of the corresponding cooking zone surface above 60°C. When the cooking zone has been switched off, the lamp remains on until temperature falls below 60°C.

 Pay attention when a pan/pot is left on the cooking zone that the residual heat indicator can switch off though is the cooking zone still hot from the pan with hot contents.

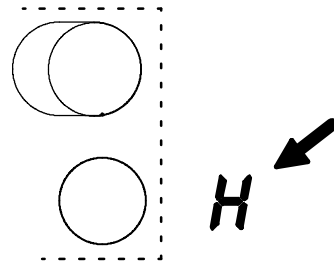

Operation

The touch controls must be pressed for at least 1 second to be activated, which will be indicated by an acoustic signal.

Switching the appliance on

1. Press the hob ON/OFF control (1) for at least 1 second.

A horizontal line appears in each power level indicator (3), and the dot (13) flashes.

 The next input must take place **within the next 10 seconds**, otherwise the hob will switch off again.

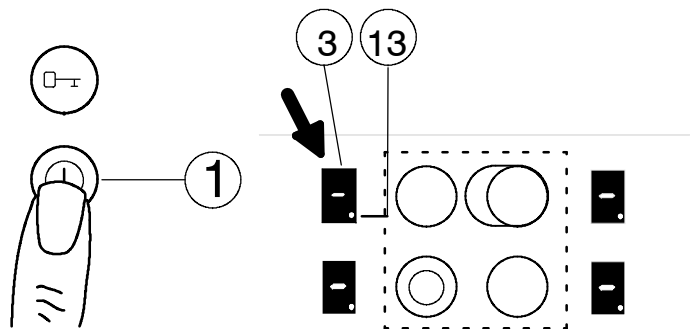



Switching on the cooking zones

Having switched on the appliance with the hob ON/OFF control (1), you can now switch on the various cooking zones within the next 10 seconds.

1. Press the cooking zone control (2) for the required cooking zone.
«0» lights up on the corresponding power level indicator. At the same time, dot (13) lights up to indicate which cooking zone is active.
2. Select a power level (1-9) using the decrease controls (5/4).

 If you select the power level using the increase control, the boost facility will be activated (see pages 66).

 The increase/decrease controls (5/4) are equipped with a repeat function. If one of the keys is continually pressed, the power level will be increased.

 Only one cooking zone control (2) can be active at a time, that is, only one dot (13) can be lit up.

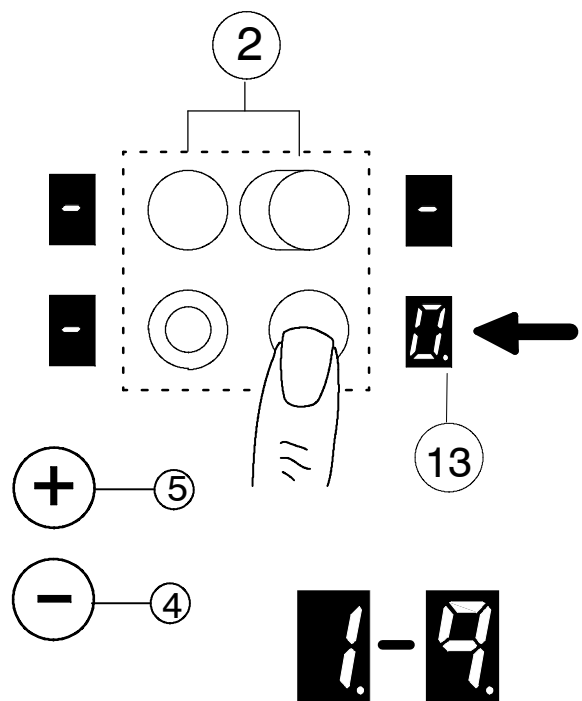

Selecting the power level

Table

The figures in the following table are intended as a guide only. The power level required for the cooking process depends on the quality of the pot and on the type and quantity of food being cooked.

In order to avoid the fat or juices from meat burning a small amount of liquid may be added to frying pan/saucepan.

During frying the food should be turned frequently.

If large quantities of meat or fish are being cooked, e.g. 1kg these should be cooked in the oven.

Power level	Cooking process	Examples of use
0	Off	
1	Keep warm	Keeping small quantities warm
2	Melting	Chocolate, butter
3-4	Heating	Pre-cooked food, sauces
4	Gentle simmer	Rice
5-6	Simmering	Stocks, cooking of stews
6-7	Power Level	Cooking Process
	Boiling	Potatoes, vegetables
7	Gentle frying	Saute vegetables, browning croutons, frying
7-8	Frying	Eggs, chops, vegetables
8	Frying	Pancakes, fritters, tender cuts of meat
9	Deep fat frying	Heating fat for deep fat frying, cooking chips, fish etc.
	Heating Up	Large quantities of liquids, soups etc.

Switching off the cooking zones

1. The desired cooking zone must be activated, i.e. dot of the corresponding cooking zone must be lit.
2. Using the decrease control (4), run the power level down to «0». The power level will be automatically switched off after a delay of 3 seconds.

To switch off quickly:

1. The desired cooking zone must be activated, i.e. dot of the corresponding cooking zone must be lit.
2. By pressing the increase and decrease controls (5/4) simultaneously, the cooking zone will be quickly switched off.

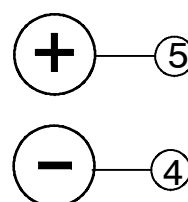

A horizontal line appears in the display when the residual temperature does not exceed 60 °C.
 “H” appears in the display if the residual temperature is above 60°C (see Residual Heat Indicator).



Try to switch off the cooking zone early, in order to make use of the residual heat.

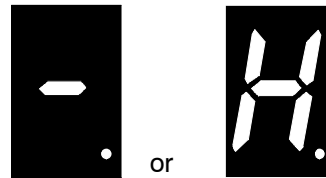

Switching off the hob

The appliance can be switched off at any time using the hob ON/OFF control (1).

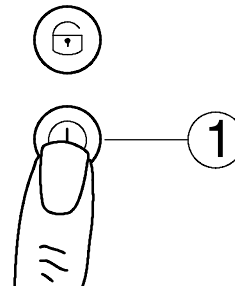

Over-cooking protection



If one or more touch controls are activated for a period longer than 20 seconds (by a pan, cutlery, overflowing food, etc.) the hob switches off completely.

Safety cut-out

If, one or more cooking zones are not switched off, the safety cut out will be automatically operated after a set time (see table below).

Heating stage	Heating time limitation in hours
1 / 2	6
3-4	5
5	4
6-8	1.5
9	1.5

Once the safety cut out has been activated, a horizontal line appears in the display if the residual temperature is below 60°C, or «H» is shown if the residual temperature is above 60°C (see Residual Heat Indicator).

In order to unlock the safety cut out, switch off the appliance with the hob ON/OFF control (1), and then switch on again.

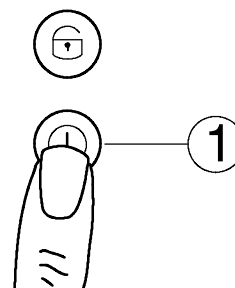

Dual-ring cooking zone

The front-left and rear-right cooking zones have the possibility of cooking with only the inner ring (**Fig. 4**) or with the outer ring as well (**Fig. 5**), depending on the cooking utensil used.

Selecting the dual-ring cooking zone

1. The desired dual-ring cooking zone (front-left or rear-right) must be activated.
The dot of the corresponding cooking zone must be lit up.
2. Selected the desired power level (1-9).
3. Switch on the second heating ring using the dual-ring key (6).

The control lamp (10) lights up, and the outer ring is switched on.

Switching the dual-ring cooking zone off

1. The desired dual-ring cooking zone (front-left or rear-right) must be activated.
The dot of the corresponding cooking zone must be lit up.
2. Press the dual-ring key (6).

The control lamp (10) goes out, and the outer ring is switched off.

Fig.4

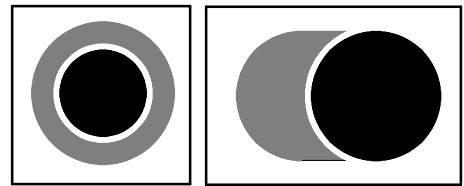
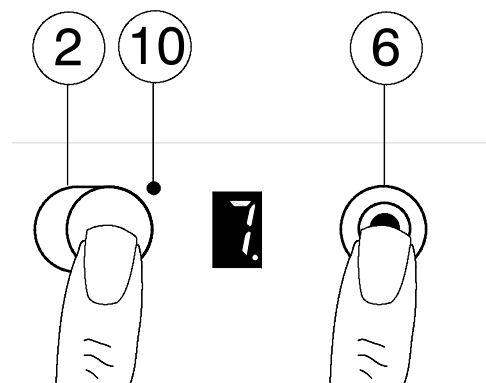
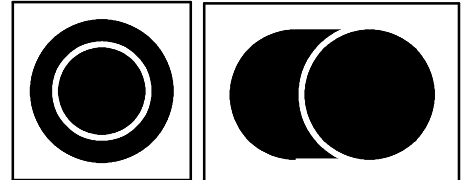

Fig.5



Safety lock - barring the appliance or the cooking zones

Locking the appliance

With the locking control (9), you can completely bar the use of the hob. **This function can be used as a child safety lock.**



If you do not switch off the Safety lock before switching off the hob, the Safety lock will still be active when you switch on the hob again. No other control can be operated until you switch off the Safety lock.

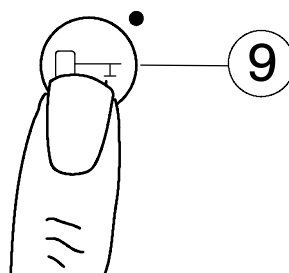

Locking (barring) the individual cooking zones

If you are working with one or more cooking zones, you can lock each individual cooking zone.

The corresponding cooking zone must be active. The dot (13) is lit, and a power level is selected.

- By pressing the respective cooking zone control (2) again, the locking system is activated. The dot (13) in the power level indicator goes out.
- If the cooking zone control (2) is pressed again, the dot appears, and the cooking zone can again be used.

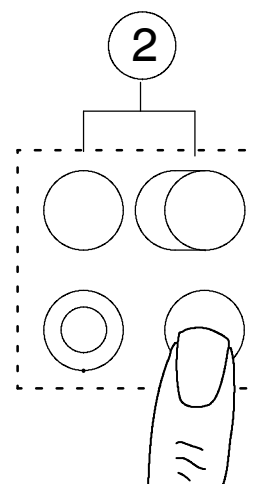

The locking system protects the following keys of the locked cooking zone from unintentional operation: **Keys 4, 5, 6, 7.**



The timer key (7) can be operated, however, and can be set (see «The Timer Function as an Egg-timer» chapter), but has no influence on the barred cooking zone.

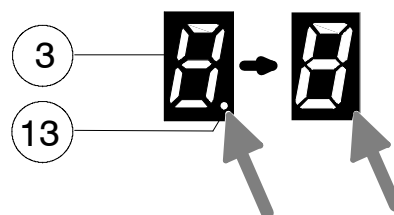

Boost facility

This facility provides an initial heat boost to the cooking zone, before its resets to the lower power level selected. The length of the heat boost is dependent on the power level selected as shown in the table below.

Selecting the boost facility

1. Press the cooking zone control (2) of the required cooking zone.
2. **Using the increase control (5),** select a power level **between 1-8**. You have 10 seconds in which to select the correct power level.

After 5 seconds, «A» appears in the power level. The boost facility has been activated.

The cooking zone will now heat up at power level 9, and, after the defined time (see Table 1), will switch down to the selected power level.

Example: You select power level 6. After 5 seconds, the boost function switches on. With this setting, the cooking zone will heat up for 2.5 minutes at power level 9, and will then switch down to power level 6.

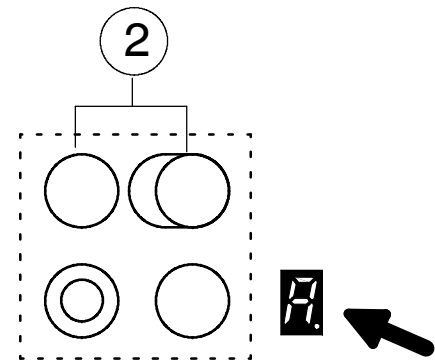
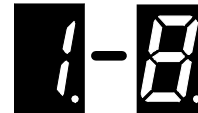

 **The automatic heat-up function will not be activated if you:**
 => select a power level using the Minus key (4)
 => select power level 9

Table 1

Power level	Automatic Heat-up function time in minutes
1	1
2	3
3	4,8
4	6,5
5	8,5
6	2,5
7	3,5
8	4,5
9	---

Indicating the selected power level

In order to have the current power level indicated in the Power Level indicator, briefly press (0.5 secs) the corresponding Cooking zone control (2).

Changing the Power Level during the Boost facility

1. The cooking zone required must be activated.
The dot (13) must be lit in the respective cooking zone, display.
2. Select another power level using the increase control (5).

If the power level is increased using the increase control (5), the time that has already expired will be taken into consideration in the calculation of the new defined time/power level.

Example: You have selected power level 1 (boost-1 minute), and wait 30 seconds. If you then switch to power level 4 (boost-6.5 minutes), the heat-up time will continue for 6 minutes (6.50 minus 0.50).



Changing the power level with the decrease control (4) will switch off the automatic heat-up function.

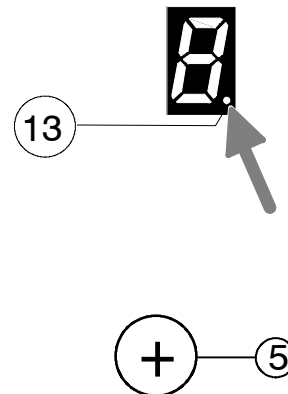

Take advantage of the residual heat by the Boost facility

For saving energy make use of the residual heat by continuing cooking on a still hot cooking zone. This means the time for the boost facility will become shorter depending on the temperature of the still hot cooking zone.

Switching off the Boost facility

As soon as "A" appears in the Power Level indicator:

1. The cooking zone required must be activated.
The dot (13) must be lit in the respective cooking zone.
2. Press the decrease control (4).

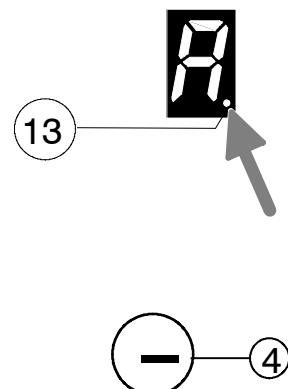

The Timer Function

This function makes cooking easier for you. You don't have to remain close to the cooking zone throughout the whole cooking process: the cooking zone will be automatically switched off at the selected time.

When no cooking zone has been programmed, the timer function can be used as an «egg-timer» (see «The Timer Function as an Egg-timer chapter»).

Switching the Timer function on

1. The desired cooking zone must be activated.
The dot (13) must be lit in the respective cooking zone.
2. Select a power level between 1-9.
3. Press the Timer key (7).
4. Using the increase/decrease controls (5/4), enter the cooking time desired (01 to 99 minutes).

The Timer function starts automatically after a few seconds.

The control lamp (11) lights up at each cooking zone that has been programmed with the timer.

 To enter the cooking time more quickly, hold down either the increase or decrease controls (5/4) respectively.

Changing the set cooking time

The cooking time can be subsequently changed where necessary:

1. The desired cooking zone must be activated
The dot (13) must be lit in the respective cooking zone.
2. Press the Timer key (7).
3. Using the increase/decrease controls (5/4), select a new cooking time.

 To enter the cooking time more quickly, hold down either the increase/decrease controls (5/4) respectively.

Calling up the current cooking time

- To call up the programmed cooking time remaining for the respective cooking zone, press the corresponding cooking zone key (2).

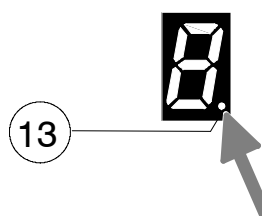
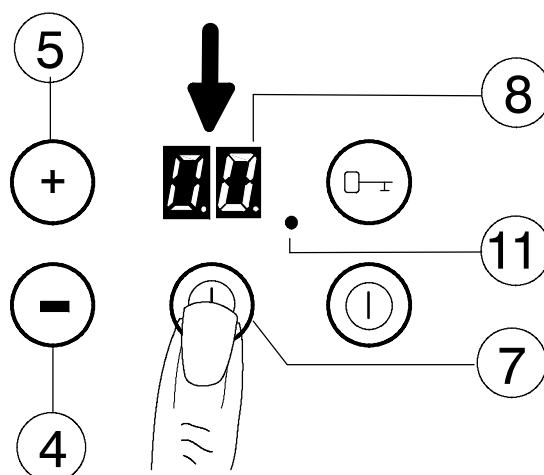

Switching the Timer function off

When the programmed time expires . . .

an acoustic signal sounds for 2 minutes, and, at the same time

the control lamp (11) of the timed-out cooking zone flashes (2 minutes).

- To switch off the acoustic signal before the 2 minutes has expired, press any key.

The cooking zone is now switched off.

. . . or if you want to switch the timer off early:

1. The desired cooking zone must be activated.
The dot (13) must be lit in the respective cooking zone.
2. Press the Timer key (7).
3. Using the decrease control (4), run the time down to «00».

The timer function is now switched off, although the cooking zone remains activated until you switch it off manually.

To switch off quickly:

1. The desired cooking zone must be activated.
The dot (13) must be lit in the respective cooking zone.
2. By simultaneously pressing the increase and decrease controls (5/4), the cooking zone is switched off.
The timer display remains, but is no longer activated.

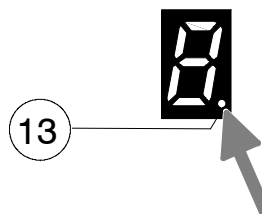
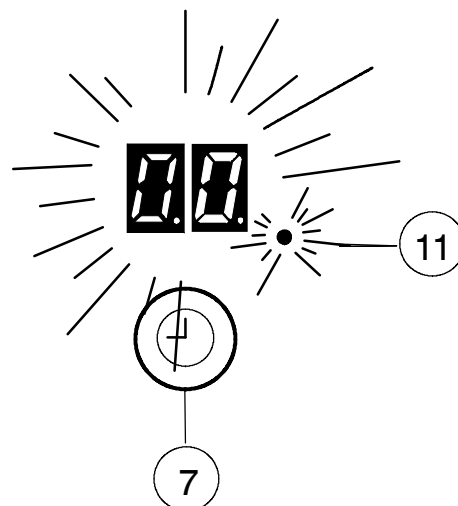

The Timer Function as an Egg-Timer

The Timer function can be used as an «egg timer», as long as the timer is not already being used for a cooking zone.

Setting the egg timer

If the appliance is switched off:

1. Press the Power On key (1).
2. Press the Timer key (7).
3. Enter the desired time using the increase-decrease controls (4/5).

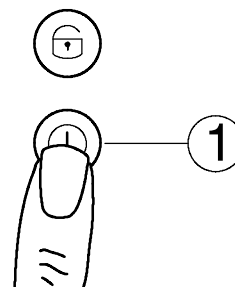

If one or more cooking zones are already in use:

1. Lock all cooking zones (see the «Locking (barring) individual cooking zones» chapter).
No decimal points (13) should be lit up in any of the power level indicators (3).
2. Press the Timer key (7).
3. Enter the desired time using the increase-decrease controls (4/5).

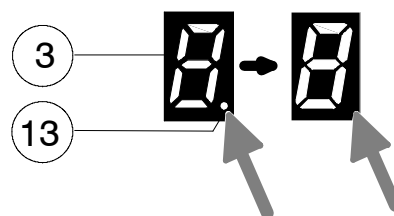

Switching the egg timer off

If the time has already expired...

«00» flashes for 10 seconds,

an acoustic signal sounds for 2 minutes.

- To switch off the acoustic signal before the 2 minutes has expired, press any key.

...or if you want to switch the timer off early:

1. Press the Timer key (7).
2. Using the decrease control (4), run the time down to «00».

The timer function is now switched off.

To switch off quickly:

- Simultaneously pressing the increase and decrease controls (5/4), the egg timer is switched off.

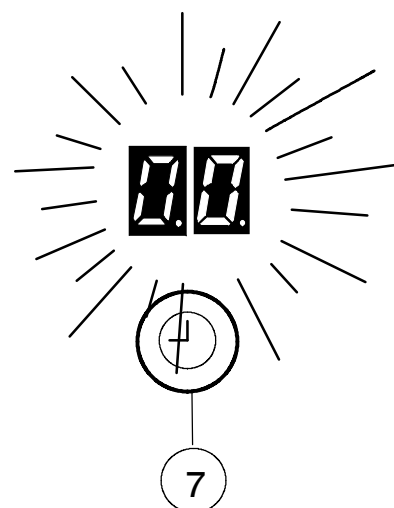

The right cooking utensils

Energy consumption

To save energy, you should . . .

- use only cooking and frying utensils with smooth, flat bottoms.
- place pots and pans in position before switching on the cooking zone.
- Wherever possible, cover pots and pans with a lid.
- switch off the cooking zone a few minutes before the end of the cooking time, in order to make use of the residual heat.
- use the residual heat of the cooking zones for keeping food warm or for melting.
- Position pots and pans centrally on the cooking zones.

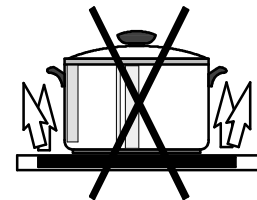
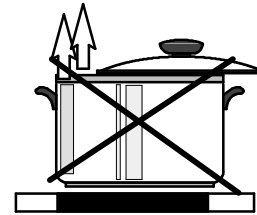
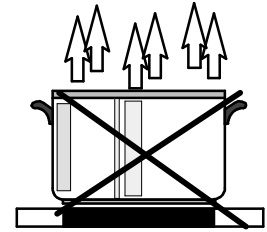
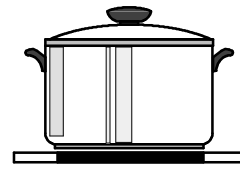

Saucepans and frying pans

Saucepans and frying pans should not be smaller than the cooking zone, and preferably not more than 10-15 mm larger than the diameter of the cooking zone.

Always use cooking and frying utensils with smooth, flat bottoms.

The bottoms should always be clean and dry. Cook with a lid in place.

Check that the bottoms of utensils are smooth and undamaged; bottoms with burrs and sharp edges will scratch the ceramic glass surface.

Scratches can also be caused by grains of sand (e.g. originating from the previous washing of vegetables), drawn over the cooking surface with the pan, or by burrs and the rims of pan bottoms.

To avoid scratching or damaging the ceramic cooking surface, pots and pans should be moved on the plate by lifting them, and **not by sliding**.

Utensils with aluminium and copper bottoms can leave behind metallic discolorations which can only be removed with difficulty or sometimes not at all.

When cold, pan bases normally curve slightly inwards by approx. 0.1 - 0.5 mm (are concave). In no case should they curve outwards (be convex).

Follow any guidelines provided by the saucepan manufacturer. Ensure they are recommended for use on ceramic hobs.

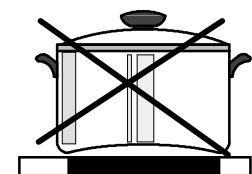
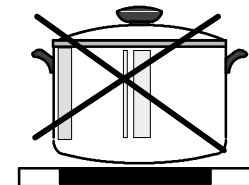

 Check that the appliance is switched off after use.

Cleaning and care

Before cleaning, make sure the hob is cool and disconnected from the power supply.

-  Never use aggressive or abrasive agents, such as oven sprays, stain or rust removers, scouring powder, or sponges with an abrasive effect.

Special cleaning agents such as Hob Brite and ceramic hob scrapers are available from department stores, electrical specialist shops, and in drug and grocery stores.

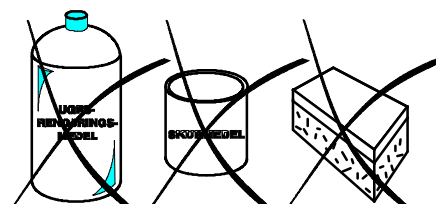

Cleaning after each use

- Slight, non-burnt soiling** can be wiped off with a damp cloth.
- Burnt soiling** has to be removed with a scraper. Afterwards wipe off the ceramic hob with a damp cloth, and Hob Brite.



Stain removal

- Light metallic stains (aluminium residues)** can be removed from the cooking zone with a ceramic hob cleaning agent such as Hob Brite when cool.
- Sugar solutions, food stuffs with a high sugar content, plastics, or kitchen foil** - must be removed immediately with a scraper. If this type of soilage is not removed immediately it can cause irreparable damage to the ceramic surface. When the surface has cooled wipe over with a damp cloth and Hob Brite.
- Before using any detergent or cleaning agent on the ceramic top, ensure they are recommended by the manufacturer for use on ceramic hobs.
- Do not apply any cleaning agents to hot cooking zones. Ensure any residues are wiped off before the cooking zones are used again.

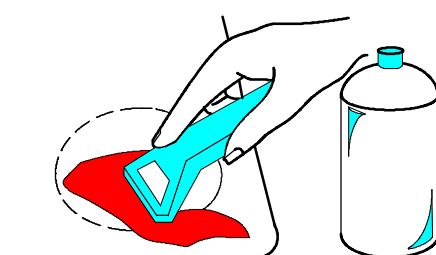
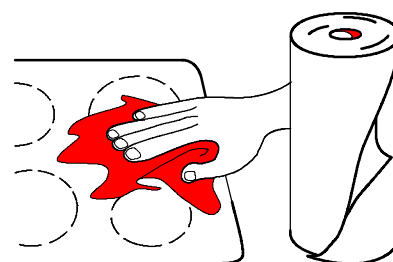

Special problems	
.. if a chemical cleaner proves inadequate	Check whether the use of a scraper is more effective.
.. when dark stains occur	If the use of a scraper and a stainless steel cleaning agent proves unsuccessful, your decor surface has most likely been abraded by using unsuitable cleaning agents, or by pan bottoms with a scouring effect. This will not impair the efficiency of your cooking surface.
.. when metallic discolourations appear on the cooking zones	Pots and pans with unsuitable bottoms, or unsuitable cleaning agents have been used. The discolourations can only be removed with considerable effort, using a ceramic glass or stainless steel cleaning agent.
.. when the surface shows scratches or impressions	These blemishes, caused by scraping or melted on objects, cannot be removed. This will not impair the efficiency of your cooking surface.

We accept no liability for improper handling of the ceramic cooking surface!

What to do when . . .

First aid for faults

When a fault occurs, it is possible that this is the result of a small error, which you can remedy yourself using the following notes.

Do not carry out any other work yourself, if the information below does not help your specific problem.



Repairs to the appliance must only be carried out by specialists. Improper repair work can result in considerable danger for the user. If you need repair work carried out, contact your specialist dealer, or our Customer Service department.

What do I do when . . .

. . . a buzzing noise is heard when a zone is heating up?

- This is not a fault.
It will stop as the heat increases.

. . . discolorations appears in the cooking zone?

- This is not a result of changes in the material, but is burned-in remnants that have not been regularly removed. They will have no effect of the function or the durability of the ceramic hob.

. . . the cooking zones do not function?



Check whether

- the appliance is switched on,
- the control lamps are on in the operating field,
- the respective cooking zone is switched on,
- the cooking zone power level has been set to the desired cooking-on level,
- the fuses in the house installation (fusebox) have tripped.
If the fuses repeatedly trip, call in an approved electrician.
- the safety cut-out of the cooking zones has been tripped.

. . . the cooking zones cannot be switched on?



Check whether

- the operating field is locked,
- a time period of more than 10 seconds has expired between the operation of the On/Off key and switching on the desired cooking zone,
- the touch surface is too large
(the finger should only be used lightly)
- the touch switch has been partly covered by a damp cloth or by a liquid.
- the operating field has been touched too early following a mains failure (to clear the condition, switch the fuse out and then in again).

. . . the displays all go out except for the "H" for residual heat?



Check whether

- the On/Off key has been accidentally operated,
- the touch switches are partly covered by a damp cloth, liquid or something similar.

. . . the displays suddenly go out?



Check whether

- the electricity supply has been temporarily disconnected, or has failed.

. . . after switching off, no «H» for residual heat is displayed ?



Check whether

- The cooking zone has only been in operation for a short time, and is therefore not hot enough.

If the cooking zone is hot, please call in an approved electrician, or call our Customer Service department.

. . . one of the cooking zones cannot be switched off ?



Check whether

- the touch keys are partly covered by a damp cloth or a liquid.
- the corresponding cooking zone key (2) is active, i.e., the decimal point (13) is lit up.

If you call in Customer Service as a result of one of the items listed above, or as a result of incorrect operation, the visit of the Customer Service technician will not be free of charge, even during the guarantee period.



If when switched on the control system can no longer be operated for any reason or due to a defect, the local main switch must be opened or the relevant fuse unscrewed, and Customer Service informed.



If any fissures or cracks appear on the hob's surface, the hob must be switched off immediately. Disconnect the appliance from the mains and inform the service department.

Important!

The following details are necessary for the service department:

Type

Model

Product-no.

You will find these details under «Technical data».

Technical Data

ZKT 662 LN



Hob dimensions: length: 572 mm
 depth: 502 mm
 height: 48 mm

Cut out dimensions: length: 560 mm
 depth: 490 mm

Voltage: 230 V ~ 50 Hz

Total power: 7.0 kW

Modell	ZKT 662 LN	Prod.Nr.	941 591 721
Typ:	55GAD47AO	230 V AC 50 Hz	
Made in Germany	Ser.Nr.:	7,0 kW	

ZANUSSI   

We reserve the right to make technical changes.

Unpacking and control

Please examine the appliance for any damage sustained during transportation!

If the appliance is damaged contact your retailer before the appliance is connected.

Packing material should be disposed of properly.

Please keep packaging away from children, and dispose of with due regard for the environment.

Installation Instructions



The appliance must only be installed by a qualified electrician.

During installation, and when carrying out service work, the appliance must be separated from the electrical supply: Remove the fuse, or switch off circuit breaker.

The general guidelines for the operation of electrical appliances, the regulations of the responsible electricity-supply company, and the information in the installation instructions must be followed exactly.



Damaged hobs with cracks or breakages in the glass-ceramic surface must not be connected to the electrical supply.

Installing into a kitchen worksurface



The electrical safety of the appliance must be ensured by a correct installation.

Protection against accidental contact with electrical elements, and the electrical safety according to the SEV/VDE regulations must be ensured by the correct installation of the appliance in standardised, matching, mounting cabinet. This also applies to the metallic lower casing of the appliance. The latter must not be freely accessible, even for installations away from the wall.

Installation cabinets must be installed and secured so that they cannot tip over.

Installation dimensions

The opening in the cabinet must correspond to the standard dimensions. The necessary information can be found in the dimensional sketch.

- The separation between the lower surface of the hob and the parts of the furniture below it must be at least **20 mm**.
- The lateral separation between the sides of the hob and the cabinet must be at least **50 mm**, and must be at least **50 mm** from the rear panel.

This appliance conforms to Type Y (IEC 335-2-6) with regard to fire protection. Only appliances of this type may be installed on one side of adjacent cabinets or walls.

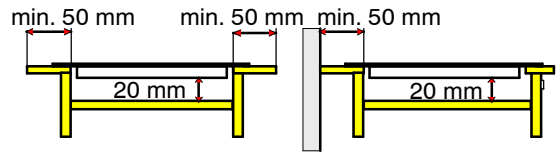

Installation

1. Cut out the worktop according to the prescribed dimensions (**Fig.1**). (Saw exactly along the scribed line.)
2. Fix according to **Fig. 2**
Position **A** must be used for screwing-on the catch springs (**Fig.1**).

Important: The screw must be driven into the worktop as illustrated.

Avoid overtightening. Do not use electric or pneumatic screwdrivers unless they have, adjustable slipping clutches (set to 1-1.1 Nm).

3. Check the sealing for proper fit and full contact.
4. Place the ceramic hob in the cut-out.

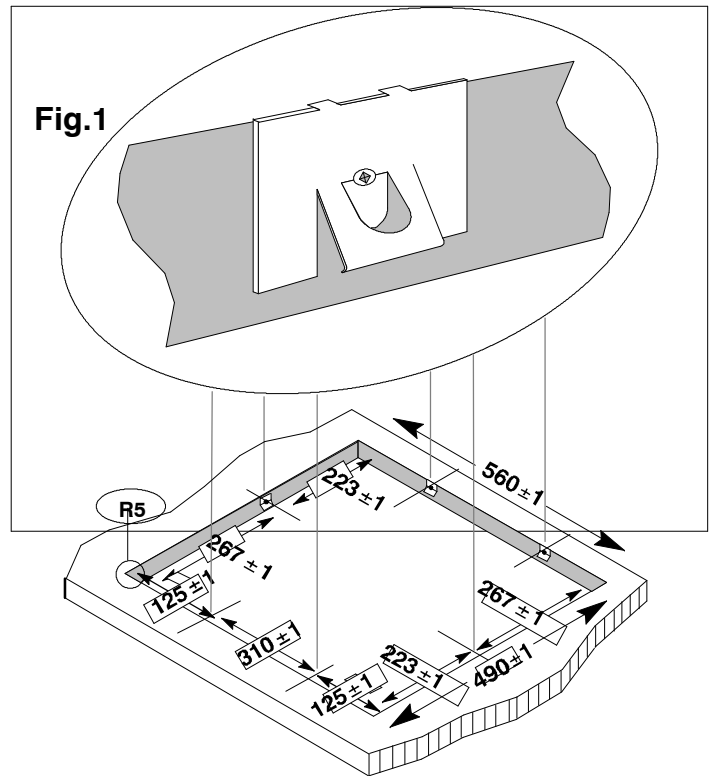

Removing the glass-ceramic hob

1. Disconnect the appliance from the electrical supply.
2. Push the hob upwards from underneath.

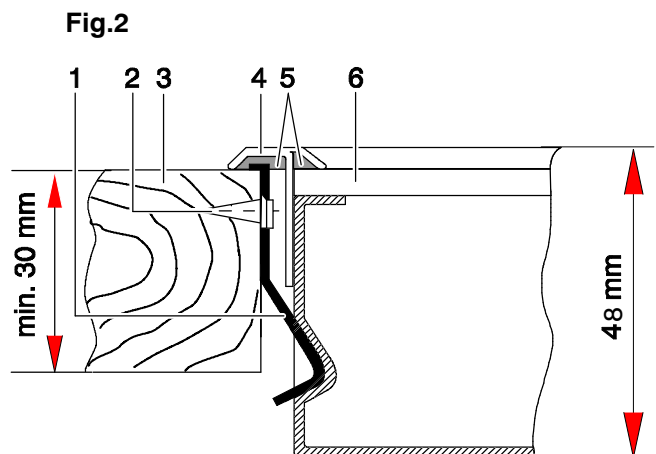

- | | |
|----------------|-----------------------|
| 1 Catch spring | 4 Frame |
| 2 Screws | 5 Sealing tape |
| 3 Worktop | 6 Glass ceramic plate |

Contrary to the Regulations for House Installations of the SEV, par. 47330.1, the built-in appliance may be installed in flammable material. Parts, side panels, reinforcement rails etc., which protrude into the space below the cooking zones must be made of inflammable materials.

Limitation of this space: width 550 mm, height 20 mm from the underside of the hob, depth 60 mm from behind for a worktop depth of 600 mm. Inflammable walls and ceilings must be fitted with fire-resistant coatings above the cooking surface, in accordance with the fire brigade regulations for the respective area.

Electrical connections

Before connecting the appliance, check that the voltage quoted on the rating plate – that is, the nominal voltage of the appliance – corresponds to the available mains voltage. The rating plate can be found on the lower housing of the glass-ceramic hob.

The mains connection of the ceramic hob must take place using the provided connection cable in accordance with the connection diagram (Fig. 3), and must be carried out so that it is possible to disconnect all poles with a contact opening of at least 3 mm, e.g., using an LS circuit breaker, earth-leakage circuit breaker, or fuse.

If the mains connection cable has to be replaced, a cable with Spare Parts No. 374 3700 00/1 must be used.

Remove any protective films from the cooking surface.



After connecting the electrical supply, all cooking zones should be briefly switched on one after the other at their maximum power, in order to test whether they are operational.

braun	=	brown
schwarz	=	black
blau	=	blue
grün/gelb	=	green/yellow
brun	=	brown
noir	=	black
bleu	=	blue
vert/jaune	=	green/yellow
marón	=	brown
negro	=	black
azul	=	blue
verde/amarillo	=	green/yellow

Fig.3

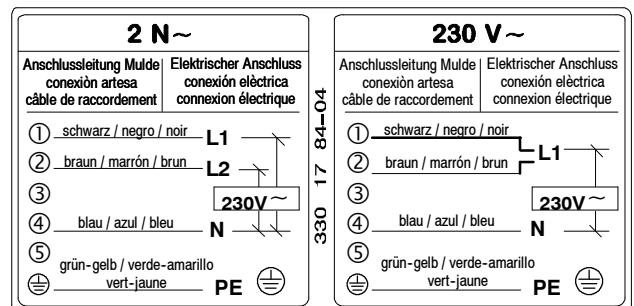

ZANUSSI