

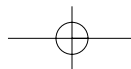

EN

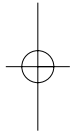

THOMSON

u s e r
m a n u a l



THOMSON
46 quai Alphonse Le Gallo
92648 Boulogne
Cedex FRANCE
www.thomson.net

55928090

PDP2075

IT IS IMPORTANT TO READ THIS INSTRUCTION BOOK PRIOR TO USING YOUR NEW PRODUCT FOR THE FIRST TIME.

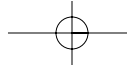

Safety Information

EN

CAUTION!

Invisible laser radiation when open. Avoid exposure to beam. Class I laser product. This system must be opened only by qualified technicians to prevent accidents caused by the laser beam.

LASER $\lambda = 780 \text{ nm}$, P max = 5 mW

Rating Information: At bottom of the unit this unit comply with the existing requirements



In accordance with the rating plate of the unit, this unit complies with current standards concerning electrical safety and electromagnetic compatibility.



ADVARSEL
USYNLIG LASERSTRÅLING VED ÅBNING NÅR SIKKERHEDSÅFBRYDERE ER UDE AF FUNKTION. UNDGÅ UDSÆTTELSE FOR STRÅLING.
VORSICHT!
UNSICHTBARE LASERSTRALLUNG
WENN ABDECKUNG GEÖFFNET UND SICHERHEITSVEREGLUNG ÜBERBRÜCKT
NICHT DEM LASERSTRAHL AUSSETZEN!

CAUTION - INVISIBLE LASER RADIATION WHEN OPEN AND INTERLOCKS FAILED OR DEFEATED. AVOID EXPOSURE TO BEAM.
ATTENTION - RAYONNEMENT LASER INVISIBLE DANGEREUX EN CAS D'OUVERTURE ET LORSQUE LA SECURITE EST NEUTRALISEE.
EXPOSITION DANGEREUSE AU FAISCEAU.



CLASS 1 LASER PRODUCT
LASER-KLASSE 1
APPAREIL A LASER DE CLASSE 1
LUOKAN 1 LASERLAITE
KLASS 1 LASERAPPARAT

WARNING-
OSYNLIG LASERSTRÅLING NÅR DENNA DEL ÅR ÖPPNAD OCH SPÄRRAN ÅR URKOPPLADE. BETRÄKTA EJ STRÅLEN.
VARO!
AVARTTAESSA JA SOJUALUKUTUSOHITETTAESSA OLET ALLTIINA NÄKYMÄTTOMÄLLE.
LASERSÄTELYLLE ÄLÄ KATSO SÄTEESEEN.

 THE LIGHTNING FLASH AND ARROW-HEAD WITHIN THE TRIANGLE IS A WARNING SIGN ALERTING YOU OF "DANGEROUS VOLTAGE" INSIDE THE PRODUCT.	 CAUTION RISK OF ELECTRIC SHOCK DO NOT OPEN CAUTION: TO REDUCE THE RISK OF ELECTRIC SHOCK, DO NOT REMOVE COVER (OR BACK). NO USER-SERVICEABLE PARTS INSIDE. REFER SERVICING TO QUALIFIED SERVICE PERSONNEL.	 THE EXCLAMATION POINT WITHIN THE TRIANGLE IS A WARNING SIGN ALERTING YOU OF IMPORTANT INSTRUCTIONS ACCOMPANYING THE PRODUCT.
---	---	---

WARNING: TO PREVENT FIRE OR ELECTRICAL SHOCK HAZARD, DO NOT EXPOSE THIS PRODUCT TO RAIN OR MOISTURE.

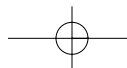

Table of Contents

EN

Safety Information

Before you begin 2

CD Player

General Control 3

Power Supply 4

 AC Outlet Power Supply 4

 Battery Power Supply 4

 Recharge function 4

The Display 5

Listening to Compact Disc 5

Playback 5

Resume 6

Skip/Search 6

Pause 6

Stop 6

Playlist 7

View the playlist 7

Clear the playlist 7

EQ. setting 7

Lock 7

Listening to a mp3 disc 8

Folder selection 8

Skip/Search 8

Smart sort 8

Playmode 8

SmartTrax

Playlist 9

View the playlist 9

Clear the playlist 9

Navigation chart 10

FM radio

Listening to FM Radio 11

Auto Search 11

Setting Presets 11

Using Presets 11

Clearing Presets 11

More Information

Useful Advice 12

Notes on CD-R/RW Discs 12

Please Respect The Environment 13

Headset Safety 13

Technical Specification 13

Before you begin

Unpacking Your Unit

You should have the following:

- one main unit
- one remote control
- AC/DC power adapter
- one set of clip phones
- one user's guide
- batteries

How to Use Your Clip Phones (The e.clipz)

The right ear clip phone is labeled R while the left ear clip phone is labeled L.

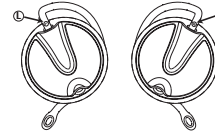

1. Pull the ear hook away from the ear pad slightly. You will hear a click sound.

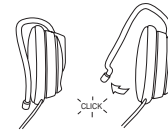

2. Slide the ear hook behind the ear with the ear pad on the front of the ear. Rotate the clip phone so the ear pad fits closely with the ear.

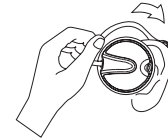

3. Lock the clip phone in place by pushing down on the top of the ear hook until it locks.

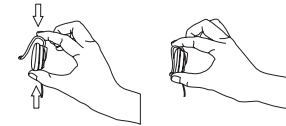

4. For best sound quality, make sure the earpad fits closely with your ear.



CD Player

EN

General Control

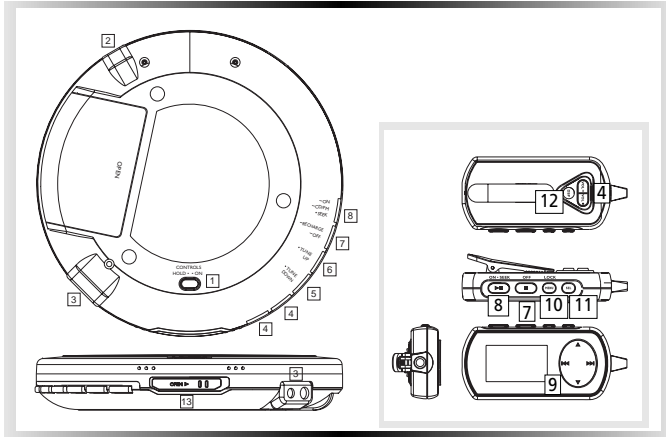

1. **controls** switch - To lock or unlock the buttons.
2. DC jack - You can insert the adapter instead of batteries for indoor use.
3. Remote Jack - Insert your remote here.
4. Volume buttons - To adjust the volume.
5. **▶▶ tune up** - Skip / search forward track; search up radio frequency.
6. **◀◀ tune down** - Skip / search backward track; search down radio frequency.
7. **■ stop** button - Press to stop CD playback, press and hold to turn off the unit. In stop mode, press and hold to activate recharge function.
8. **▶|| play/pause** button - Press to play or pause CD.
9. **Directions** button - access different option in the option menu; enter / exit a folder.
10. **menu•lock** button - press to enter / exit option menu, press and hold to activate key lock function.
11. **sel** button - select the highlighted option.
12. **DSP** button - For different EQ selection.
13. **open** switch - Slide to open CD door.

3

CD Player

EN

Power Supply

Model Number	AC/DC adapter	Batteries
PDP2075	5-4079A (Included) (230V 50Hz)	2 x 1.5V IEC R6 (UM3) (Included)

AC Outlet Power Supply

You can power your CD player with an AC/DC adapter. Refer to the table for details of the operating voltage.

AC/DC adapter is purposed for indoor use in dry rooms only. Remove the jack from the device to use it with the batteries.



Note:

Power is fed to the unit even when it is not functioning. To cut the power supply off, the AC/DC adapter must be unplugged.

Battery Power Supply

Refer to the table for details of the batteries required to operate your unit.

Recharge function

To charge Ni-Cd / Ni-MH batteries:

1. Insert 2 rechargeable batteries into the battery compartment on the main unit.
2. Connect the main adapter.
3. Press and hold **stop ■** on the unit to start recharging. A battery indicator will be displayed when recharging is in progress.
4. Unplug the AC/DC adapter to stop recharge, or press **play** to stop recharge and enter playback mode directly.

4

CD Player

EN The display

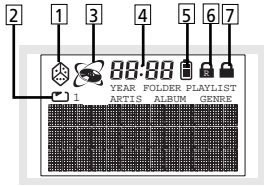

1. Random playback
2. Repeat
3. SmartTrax disc is detected
4. Time display
5. Battery Indicator
6. Key lock (remote control)
7. Key lock (main unit)

* For different playmode icons, please refer to the playmode section.

Listening to a Compact Disc

Slide the **open** switch to the right to open the door. Insert a disc and press lightly on the centre to lock. Close the door.

Playback

Press **play/pause** ►|| on the main unit or remote to start playback.

Reading DISC will appear on the display. Then, the total number of tracks and time of the CD will be displayed. If the disc compartment is empty or the disc cannot be read, No Disc will appear on the display.

The **Electronic Shock Protection (ESP)** system prevents sound interruptions when impacts or vibrations occur. Electronic anti-shock consumes less power and increases the battery life. Therefore, the ESP function is always on.

After many successive impacts, the buffer might be emptied causing a brief sound interruption for the memory to reload.

CD Player

Resume

When you power off the unit, resume is automatically activated. It stores settings concerning playmode and EQ. When the unit is on again, it resumes to the original settings.

Skip / Search

Press ◀◀ to skip to the previous track. Press and hold to search backward in a track. Press ▶▶ to skip to the next track. Press and hold to search forward in a track.

Pause

During playback, press **play/pause** ►|| on the main unit to pause playback. The minutes and seconds flash when the playback is paused.

Stop

Press **stop** ■ on the main unit.



EN Note:

To prevent excessive battery consumption, when finished all tracks or in stop state, the unit switches off automatically in all modes after no key has been activated for 30s.

CD Player

EN

Playlist

Folders and tracks can be bookmarked and placed into the playlist.

1. Press ▲ or ▼ to select the folder to enter.
2. Press ◀ or ▶ to enter / exit the folder.
3. Press **sel** to select the whole folder or individual title to place into the playlist.

View the playlist

1. Press ▲ or ▼ to select the playlist.
2. Press **sel** to enter and view the playlist.

Clear the playlist

1. Press **menu•lock** to enter the option menu.
2. Press ▲ or ▼ to select "Clr Playlist".
3. Follow the instructions to clear the playlist.

7

EQ setting

Press **DSP** on the remote repeatedly to select among Flat, Bass Boost, Rock, Jazz and Classic.

Lock

Slide **controls** switch on the main unit to the **HOLD** position, or press and hold **menu•lock** on the remote for 2 second to lock the button to avoid accidental activation of unwanted functions. "HOLD" will show on the display when the control is locked.

CD Player

EN

Listening to a mp3 Disc

Press **play/pause** ►► on the main unit to start playback. "Reading file system..." will appear on the display. If the disc compartment is empty or the disc cannot be read, **No Disc** will appear on the display.

Category selection

Press ▲ or ▼ to select a category. Press ◀ or ▶ to enter / exit the selected category.

Skip / Search

During playback, press ◀ to skip to the previous file. Press and hold to search backward in a file. Press ▶ to skip to the next file. Press and hold to search forward in a file.

Smart Sort

This function enables the user to sort all the songs according to their artist, album, genre, year, folder, etc.

1. When the unit is in stop mode, press **stop** ■ repeatedly to sort songs in different methods.
2. When the unit is in play mode, press the Directions button repeatedly to sort songs in different methods.

Playmode

You can play the tracks in a random order, play the entire CD or one track as many times as you wish, as well as listen to the beginning of each track for 10 seconds.

In the option menu, select "Shuffle", "Repeat" or "Intro", then press **sel** to toggle ON / OFF. There are various combinations which you can try them out, here are some examples.

- ☐ 1 Play the current track repeatedly.
- ☐ Play all tracks within the current layer repeatedly.
- ⊗ Play tracks randomly.

8

SmartTrax

EN

SmartTrax is a music navigation system that allows for the organization of mp3 or WMA files into various standardized categories. The categories include Artist, Title, Genre, Album, Year and CD Playlist. This systematic arrangement makes the navigation easier and faster as songs are placed into categories (e.g. Artist, Album, Genre, etc.)

To enjoy SmartTrax navigation experience, please make sure your mp3 disc is burnt with SmartTrax feature switched ON.

Smart Resume Plus

The unit is equipped with Smart resume plus features, if the newly inserted CD is considered as the same as the former one, the Smart Resume Plus feature will automatically activate. The last playback song and playmode will be restored.



Note:

When reading a SmartTrax disc which is different from the former one, the unit will automatically enter the Artist Category.

Playlist

Selected categories and tracks can be bookmarked and placed into the playlist.

1. Press ▲ or ▼ to select a category to enter.
2. Press ⏪ or ⏩ to enter / exit the category.
3. Press sel to select the whole category or individual title to place into the playlist.

View the playlist

1. Press ▲ or ▼ to select the playlist.
2. Press sel to enter and view the playlist.

Clear the playlist

1. Press menu•lock to enter the option menu.
2. Press ▲ or ▼ to select "Clr Playlist".
3. Follow the instructions to clear the playlist.

SmartTrax

EN

Navigation chart (SmartTrax mode)

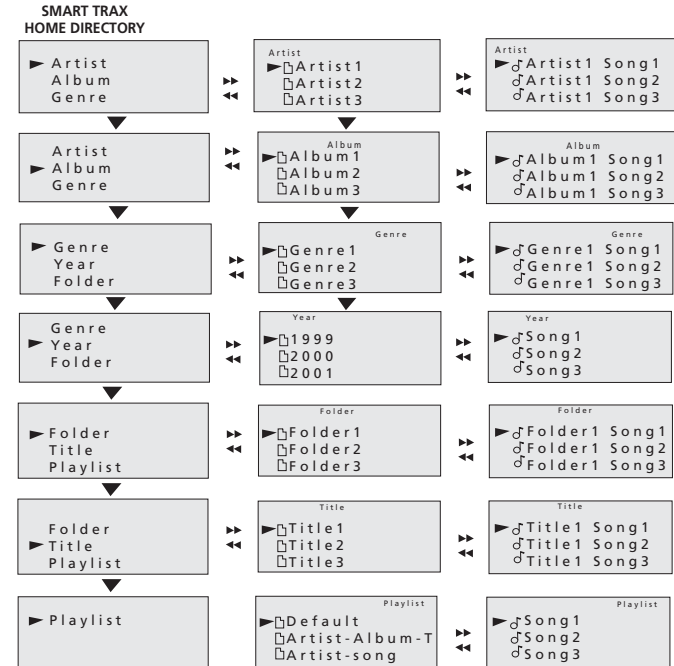

FM Radio

EN

Listening to FM Radio

1. Enter the option menu and choose "Go to radio", or press and hold **play/pause** for 2 seconds to select FM radio.
2. Press the **directions** button to search for the desired station.

Auto Search

1. In radio mode, press **play/pause** to turn on the Seek feature, then press the **directions** button to auto search up or down in FM frequency. Search will stop when a station is found. To turn off the Seek feature, press **play/pause**.

Setting Presets

Your player has 20 preset stations for easy access to your favorite FM radio stations.

You can save a radio frequency as a pre-set station:

1. Press **sel** on the remote control.
2. You can change the preset destination by pressing **▲** and **▼**.
3. Press **sel** to confirm saving.

Using Presets

1. Enter the option menu and choose "Go to radio", or press and hold **play/pause** for 2 seconds to select FM radio.
2. Press **▲** and **▼** to access the previous or next preset station.

The display will show the frequency and the preset number.

Clearing Presets

1. In radio mode, enter the option menu and choose "Clr Preset".
2. Press **▲** and **▼** to access the previous or next preset station.
3. Press **sel** to confirm clearing.

More Information

Clean the player with a soft cloth, or a damp chamois leather. Never use solvents.

Useful advice

- Do not store CDs in damp areas.
- Do not expose CDs to high temperatures.
- Do not put any tape or adhesives on either side of the disc.
- You should avoid leaving the CD door open. Dust is liable to impair performance of the laser optical unit.
- Do not use your set immediately after transport from a cold place to a warm place: there may be condensation problems.
- Do not touch the playing surface. Make sure that you keep your set away from water and high temperatures.
- If you do not use your set on battery power for more than one month, we advise you to take out all the batteries.
- To prevent personal injury, do not reverse any battery and do not mix battery types.
- Discard leaking batteries immediately. Leaking batteries can cause skin burns or other personal injury.
- This apparatus shall not be exposed to dripping and splashing.

- Prolonged use of the CD player at full volume can damage the user's ear.

SPC: Sound Pressure Control at 100dB maximum (only for Thomson models)

Notes on CD-R/RW Discs

- Do not affix any type of labels to either side (recordable or labeled side) of a CD-R/RW disc as this may result in the unit malfunctioning.
- To avoid damages to the CD-R/RW disc, do not open the disc compartment door while the disc is being read.
- Do not load an unrecorded CD-R/RW disc into the unit. This may take a longer time to read the disc.
- Playback capability for CD-RW discs may vary due to variations in the quality of the CD-RW disc and the recorder used to create the disc.

EN

More Information

EN

Please respect the environment !



Before throwing any batteries away, consult your distributor who may be able to take them back for specific recycling.

- You should use with extreme caution or temporarily discontinue use in potentially hazardous situations. Even if your headset is an open-air designed to let you hear outside sounds, do not turn up the volume so high that you are unable to hear what is around you.

Headset Safety



Have a Blast- Just Not in Your Eardrums
Make sure you turn down the volume on the unit before you put on

headphones. Increase the volume to the desired level only after headphone is in place.

- Do not play your headset at high volume. Hearing experts warn against extended high-volume play.
- If you experience ringing in your ears, reduce volume or discontinue use.

Technical specifications

* **Frequency response: 20Hz to 20kHz**

Power Supply

- 4.5V DC through AC/DC adapter
- 2 "AA" batteries
- 2 "AA" rechargeable Ni-cd / Ni-MH batteries
- 4.5V DC (through car DC adapter)

The descriptions and characteristics given in this document are given as a general indication and not as a guarantee. In order to provide the highest quality product possible, we reserve the right to make any improvement or modification without prior notice. The English version serves as the final reference on all products and operational details should any discrepancies arise in other languages.