



Delfield®

4464N FLAT TOP

Front-Breathing Flat Top Refrigerated Base

Project _____

Item _____

Quantity _____

CSI Section 11400

4464N FRONT-BREATHING FLAT TOP REFRIGERATED BASE

MODELS:

4464N

Two section refrigerator with doors

D4464N

Two section refrigerator with drawers



Model 4464N



STANDARD FEATURES

- All 4400 and 4500 Series units are 100% front breathing, which allows the unit to be pushed against a wall or built into a cabinet or an existing line up
- Durable, rugged stainless steel sides, top and front
- Features Delfield's exclusive ABS interior (on sides). ABS is extremely durable - it won't dent, chip or corrode and is backed by a limited lifetime warranty
- Heavy duty self-closing hinges
- "D" prefix models feature Delfield's exclusive new drawer system. Drawers are backed by a 10-year warranty on the track assembly
- Environmentally friendly R404A refrigerant
- High density foamed in place polyurethane keeps energy costs low
- Black recessed quick grip handle
- Standard on 2" casters for easy cleaning and installation
- 60-cycle single phase electrical system
- 7' cord and plug supplied
- Cord spring relief - prevents cord rollover
- One epoxy coated wire shelf standard, installed per door section
- ACT solid state electronic control
- One year parts and 90 day labor standard warranty.

OPTIONS AND ACCESSORIES

- Flat lift off cover
 - 18" wide single tier overshell
 - Stainless steel finish on back
 - Plastic laminate on front
 - Additional wire shelves
 - Door lock
 - Exterior thermometer
 - Interior lights
 - Glass door(s)
 - *220V/50 Hertz electrical system
- *Inclusion of this option will alter electrical specifications of the unit.

SPECIFICATIONS

Exterior top is one-piece, 22-gauge stainless steel with integral square nosing on the front.

Exterior back and bottom are two-piece 24-gauge galvanized steel.

Exterior ends are stainless steel.

Interior sides are thermoformed ABS plastic with shelves supported on plugs. Interior back is one-piece 22-gauge stainless steel. Interior bottoms are thermoformed ABS plastic. Base is fully insulated with high-density foamed in place polyurethane.

Refrigeration system uses HFC-404A refrigerant. Compressor is 1/5 H.P., with condenser coil and hot

gas condensate evaporator mounted on rear of the cabinet. Evaporator coils are located on the interior rear wall of the cabinet. Refrigerant flow is controlled by a capillary tube. Cabinet maintains an interior cabinet temperature of 36°F to 40°F (2°C to 4°C).

ACT control. ACT electronic, solid state control, mounted on the exterior rear of the cabinet, allows unit to maintain precise temperatures in heavy duty conditions.

Electrical connection is 115 volt, 60 Hertz, single phase. Unit has a 7' (2.1m) long electrical cord and NEMA 5-15P plug.

Casters Equipment is mounted on 2" (5.08cm) (2.5" ride height), diameter plate casters with front two locking.

Door has a 24-gauge stainless steel exterior, with thermoformed ABS plastic interior liner.

Drawers have 24-gauge stainless steel exterior with thermoformed ABS plastic interior liner. Drawer frames are 12-gauge stainless steel. Drawer slides are 11-gauge stainless steel with Delrin bearings. Top drawer holds one full size 12" x 20", 4"-6" (30.5cm x 50.8cm x 10.2cm) deep pan, and three 1/6 size pans. Bottom drawer holds one full size 12 x 20" and three 1/6 size 4" deep pans. Pans are supplied by others.



980 S. Isabella Road
Mt. Pleasant, MI 48858
www.delfield.com

Phone: 800-733-8948
Fax: 800-669-0619
Email: info@delfield.com

Approval _____

Date _____



Model # _____
CSI Section

4464N Front-Breathing Flat Top Refrigerated Base

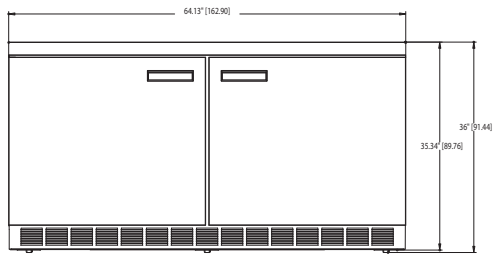

4464N ELEVATION VIEW

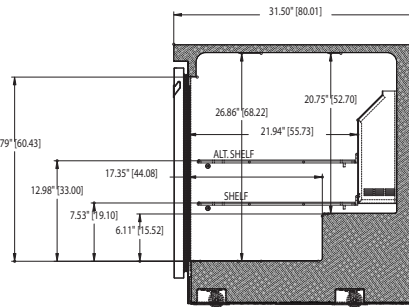

4464N RIGHT SIDE VIEW

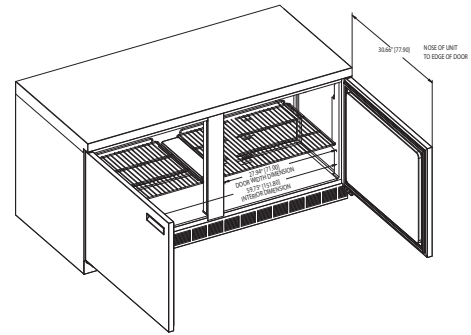

4464N ISO VIEW

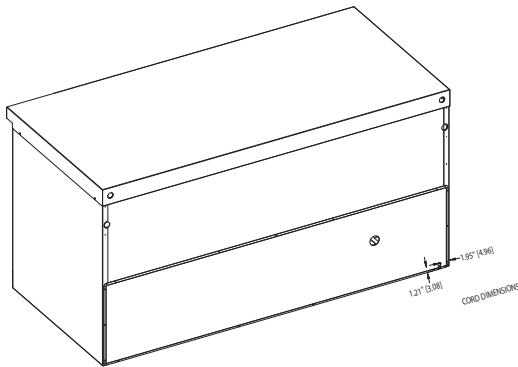

4464N & D4464N ISO VIEW

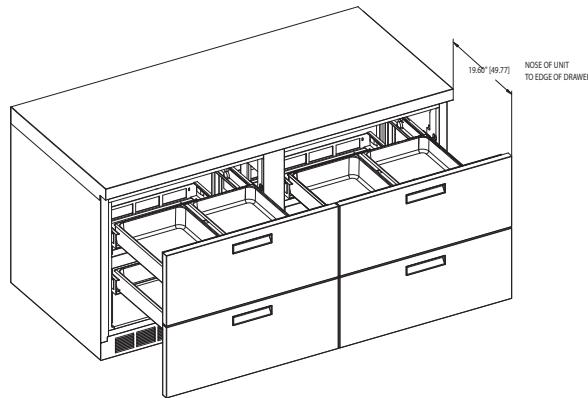

D4464N ISO VIEW

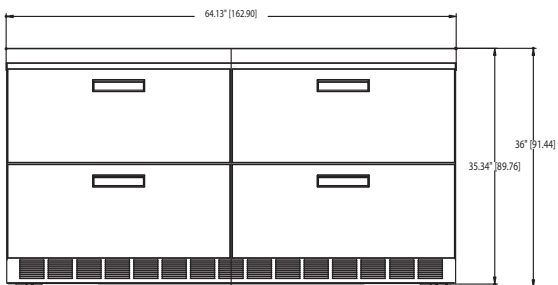

D4464N ELEVATION VIEW

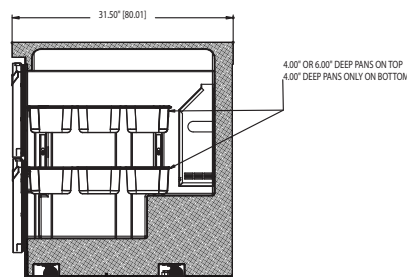

D4464N RIGHT SIDE VIEW

INSTALLATION NOTE:

Refrigeration system is designed so that air will flow under the unit, through the compressor area and out the front of the unit. Any restriction to this air flow path will void the warranties.

PLEASE NOTE:

Air flow through the louver on the back of the unit is not necessary for operation, however, any air which passes through the louver is beneficial.

Mechanical Data — Standard Unit

MODEL NUMBER	#OF SHELVES	SHELF AREA SQ. FT.	STORAGE CAP. CU. FT.	H.P.	VOLTS/HERTZ/PHASE	AMPS	NEMA PLUG	SHIP WEIGHT
4464N	2	7.76	16.7	1/2	115/60/1	12	5-15P	395 lbs/ 179kg
D4464N	NA	NA	5.4	1/2	115/60/1	12	5-15P	440 lbs/ 200kg



980 S. Isabella Road
Mt. Pleasant, MI 48858
www.delfield.com

Phone: 800-733-8948
Fax: 800-669-0619
Email: info@delfield.com

Printed in the USA.
07/06
DS4464N