

PENTAX®

OPERATING MANUAL

IQZ_{oom}105SW/120SW

IQZ_{oom}105SW/120SW

QUARTZ DATE

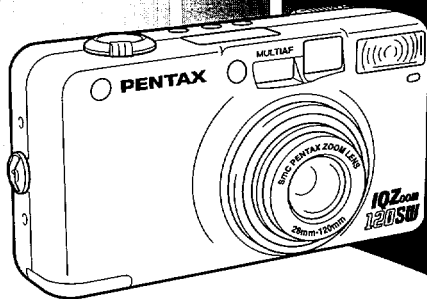
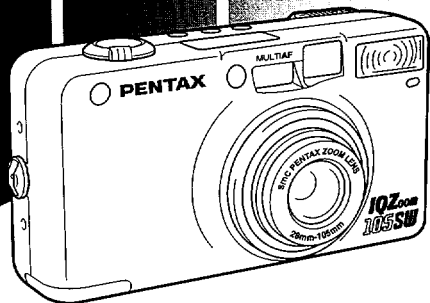







Thank you for buying the Pentax product. Please read this manual before using the camera in order to get the most out of all the features and functions.

Keep this manual safe, as it can be a valuable tool in helping you to understand all the camera's capabilities.

- This operating manual is for IQZoom 105SW / Quartz Date and IQZoom 120SW / Quartz Date.
- Pictures and illustrations shown herein may differ from the camera's actual appearance.
- Illustrations in this operating manual are the DATA MODEL.

Icon indications used in this manual

Operation direction	
Automatic operation	
Attention	
Lamp lighted	
Lamp blinking	
Correct	
Incorrect	

FOR SAFE USE OF YOUR CAMERA

Although we have carefully designed this camera for safe operation, please be sure to follow the following precautions.

⚠ WARNING This mark indicates precautions that if not followed, could result in serious injury to the operator.

⚠ CAUTION This mark indicates precautions that, if not followed, could result in minor or medium injury to the operator or damage to the equipment.

⚠ WARNING

- The electric circuits inside the camera contain high voltage working parts. Never attempt to disassemble the camera yourself.
- Never touch internal parts of the camera if they become exposed, as there is danger of electric shock.
- Wrapping the strap around your neck is dangerous. Make sure that small children do not get the strap caught their neck.
- Be sure to store batteries out of the reach of children. Seek medical assistance immediately if accidentally swallowed.

⚠ CAUTION

- Do not use the flash near anyone's eyes, as it may hurt them. Be particularly careful with the flash around infants.
- Never try to disassemble, short or recharge the battery. Also, do not dispose of the battery in fire, as it may explode.
- Remove the battery from the camera immediately if it becomes hot or begins to smoke. Be careful not to burn yourself during removal.

PRECAUTIONS FOR YOUR CAMERA

Precautions when taking pictures

- Do not allow the camera to get wet. Should the camera get wet wipe it off immediately with a dry soft cloth.
- Do not drop the camera or allow it to hit a solid object. If the camera suffers a severe shock or impact, take it to a Pentax service center for inspection.
- Be careful not to subject the camera to strong vibrations, shock or pressure. Cushion the camera during transportation.
- Condensation on the interior or the exterior of the camera may be harmful to the camera mechanism. When taking the camera from a warm temperature to a subfreezing one or vice versa, put the camera into a case or plastic bag so that any changes in temperature difference is minimized. Do not remove it from the bag until the temperature has stabilized.
- Regular size color prints may cut off what appears on the extreme edges of the film frame. Compose your picture with a margin of safety at the edges.

Precautions for storage

- Avoid leaving the camera for extended periods in places where temperature and humidity are high, such as in a car.
- Store the camera in a cool, dry place with good air circulation that is free of dirt, dust, or chemicals.

Precautions for proper care

- Use a blower and lens brush to remove dust accumulated on the lens or the viewfinder window.
- To clean the external camera surfaces - but not glass surfaces - use a dry or silicone-treated cloth.
- Never use solvents such as paint thinner, alcohol or benzene to clean the camera.

Other precautions

- The temperature range at which this camera functions properly is 50°C to -10°C (122°F to 14°F).
- The PENTAX warranty provided is only for the repair of defects in materials or workmanship. Damage of any kind cannot be repaired at no charge under the term of the warranty. If the difficulty is caused as a direct result of the product being used in conditions contrary to the instructions outlined in this manual, charges will be assessed or a repair quotation will be provided.

LCD (Liquid-crystal display)

- When the LCD is exposed to high temperatures over about 60°C, it may blacken, but when the temperature normalizes, it will return to normal.
- The LCD may also slow down in response to lower temperatures, but this is a normal characteristic of an LCD.
- In low light situations, the illuminator of the LCD panel lights up for 4sec when the camera operates.

- Use one 3V lithium battery, type CR-2 or the equivalent.
- Misuse of a battery can cause hazards such as leakage, overheating, explosions, etc. The battery should be inserted with the "+" and "-" sides facing correctly.
- Never try to disassemble, short or recharge the battery. Do not dispose of the battery in fire.
- Battery performance may be temporarily hindered in low temperatures, but will recover in normal temperatures.
- Be sure to store batteries out of the reach of children. Seek medical assistance immediately if accidentally swallowed.
- Keep a spare battery on hand for replacement convenience when shooting outdoors or while traveling.

NAMES OF WORKING PARTS

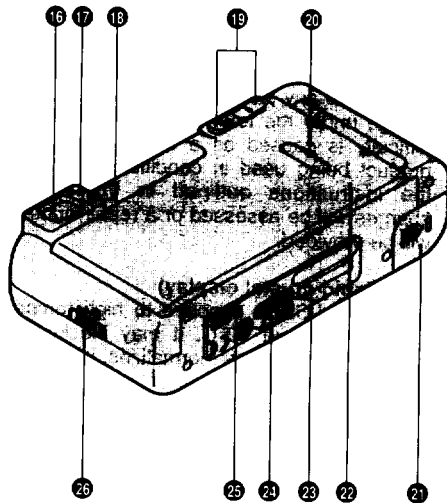
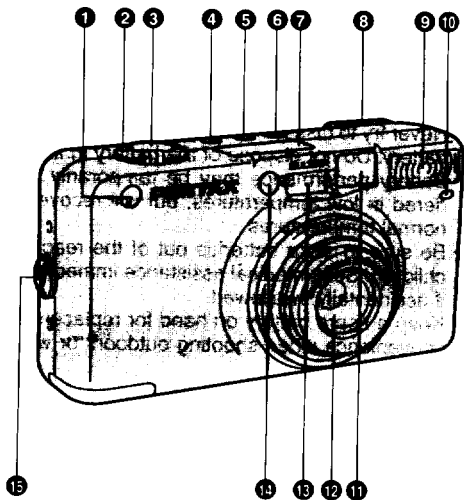

NAMES OF WORKING PARTS

- ① Remote control receiver (p.34 - 36)
- ② Main/Drive switch (p.10, 32)
- ③ Shutter release button
- ④ Date button (p.37, 38)
- ⑤ AF/Infinity-Landscape button (p.22, 23, 32)
- ⑥ Mode button (p.27)
- ⑦ LCD panel
- ⑧ Diopter adjustment lever (p.12)
- ⑨ Built-in flash
- ⑩ Self-timer lamp (p.33)
- ⑪ Viewfinder window
- ⑫ Lens
- ⑬ Autofocus window
- ⑭ Light sensor window
- ⑮ Strap lug (p.8)
- ⑯ Viewfinder eyepiece
- ⑰ Green lamp (p.12)
- ⑱ Red lamp (p.12)
- ⑲ Zoom button (p.18, 19, 38)
- ⑳ Film information window
- ㉑ Battery chamber cover (p.9)
- ㉒ Back cover (p.13 - 15)
- ㉓ Panorama switch (p.26)
- ㉔ Tripod socket
- ㉕ Mid-roll rewind button (p.16)
- ㉖ Back cover release lever (p.13, 15)

LCD PANEL

All indications will not actually appear simultaneously as shown

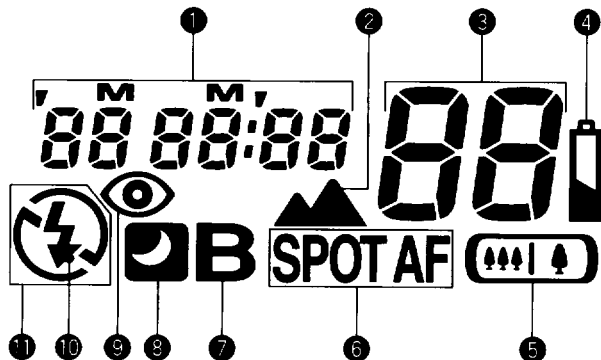

- 1 Data information (p.37)
- 2 Infinity-Landscape Mode (p.22)
- 3 Exposure counter (p.14, 15)
- 4 Battery exhaustion warning (p.10)
- 5 Zoom button (p.18, 19, 38)
- 6 Spot AF Mode (p.23)
- 7 Bulb (p.30, 31)
- 8 Slow-speed-shutter (p.29, 30)
- 9 Red-eye Reduction function (p.27, 28)
- 10 Flash on (p.29, 30, 31)
- 11 Flash off (p.29, 30)

TABLE OF CONTENTS

• For safe use of your camera	1	Composing and Focusing	20
• Precautions for your camera	2 - 3	Hard-To-Autofocus Subjects	21
• Precautions for battery usage	3	Infinity-Landscape Mode	22
• Names of working parts	4 - 5	Spot Focus	23
• LCD panel	6	Focus-Lock Shooting	24 - 25
• Table of contents	7	Panorama Mode	26
ABOUT THE CAMERA		Auto exposure mode	27
Strap attachment	8	Flash effective range	28
Installing / Replacing Battery	9	Daylight-Sync Shooting	29
Battery exhaustion warning	10	Slow Shutter Speeds Modes	29 - 30
Main switch	10	Bulb Modes	30 - 31
Viewfinder Displays	11	Shooting Modes	32
Lamp Indications	12	Self-timer photography	33
Diopter adjustment	12	Using wireless remote control (option)	34 - 36
Loading / Unloading the film	13 - 15	Date Model	37 - 38
Rewinding Film in mid-roll	16	Trouble shooting	39 - 40
Holding the camera	17	Specifications	41 - 43
TAKING PHOTOGRAPHS		Warranty policy	44 - 45
Operating the zoom lens	18 - 19		

STRAP ATTACHMENT

ABOUT THE CAMERA

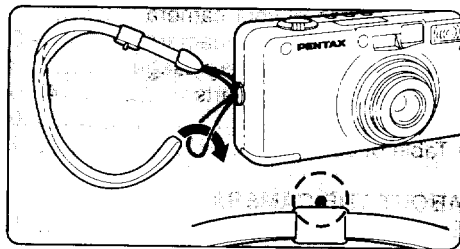

Fit the strap on the camera as illustrated.

- Use the illustrated part for pushing the mid-roll rewind button.

INSTALLING/REPLACING BATTERY

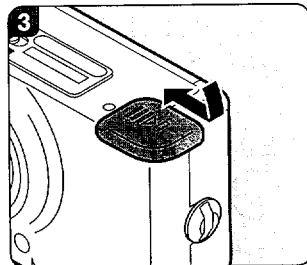
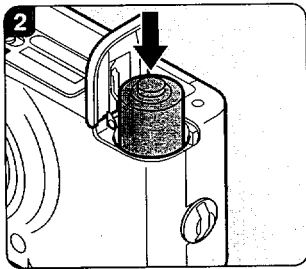
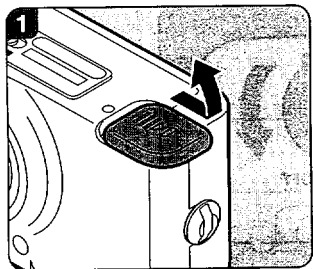



Ensure that the power is OFF before replacing the battery.

- 1 Open the battery chamber cover as shown in the illustration.
- 2 Insert one lithium battery (type CR-2 or the equivalent) with the plus/minus (+/-) sides matching the indications in the battery compartment.
- 3 Close the battery chamber cover. Ensure that the cover is locked with a click.

- On the DATE MODEL, the time is initialized to 0 00 and (----) bar appears on the LCD panel when the battery chamber cover is opened. Correct the time. See page 37, 38.

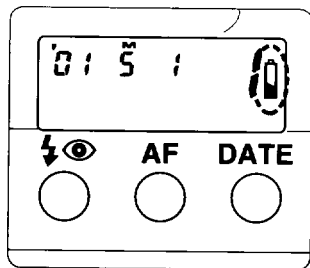
BATTERY EXHAUSTION WARNING



When the battery is nearly exhausted, the battery symbol () appears on the LCD panel to warn you. Replace the battery as soon as possible. When () starts blinking, no operations can be performed.

Battery life (using 24-exposure film rolls):

Approx. 8 rolls using flash 50% of the time (using the CR-2 battery and under Pentax testing conditions). Actual battery life/performance may vary drastically depending on usage of Power Zoom, Flash and external conditions such as temperature and freshness of the battery.

10

MAIN SWITCH

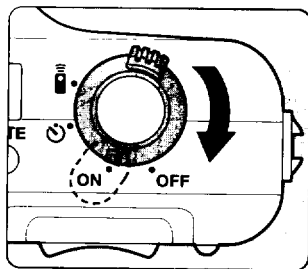

To switch ON, set the main/drive switch to the ON position.

When the power turns ON, the lens slightly extends and the lens cover opens. The camera is now ready to shoot.

- If the camera is ON and left unused for over 3 minutes, the lens automatically retracts to the shortest focal length.

VIEWFINDER DISPLAYS

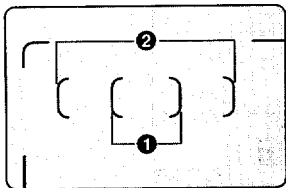

For normal photography, compose the scene within these frame.

① Multi-focus and Spot AF Frame

When the lens is set at the wide-angle setting, compose the scene within this frame.

Select the Spot AF frame to focus on a particular spot in the frame.

② Multi-focus Frame

When the lens is set at the telephoto end setting, compose the scene within this frame.

- For other focal length, the range widens as the foocal length increases from wide-angle to telephoto end.

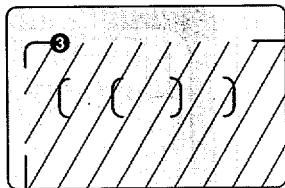

③ Close distance compensation Frame

When the camera-to-subject-distance is closer than 1.2m, compose the scene within this frame.

- When the camera-to-subject distance is less than 1.2m, the panorama photography is not recommended due to a substantial difference between what you see through the viewfinder versus the picture you will obtain the actual picture taking area.

LAMP INDICATIONS

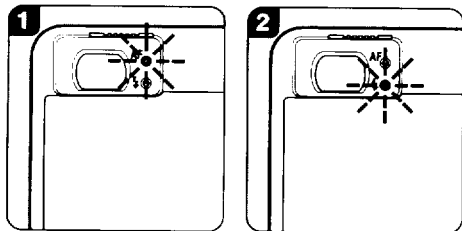

When you depress the shutter release button halfway down, the green lamp and/or red lights up or blinks as shown above.

● **Green lamp (Focus status AF) :**

When the subject is in focus, it will light up to indicate that you can take the picture. When the subject is not in focus, it will blink, indicating that you cannot take the picture.

● **Red lamp (Flash status \downarrow) :**

When the flash is ready to discharge, it will light up. When the flash is being charged, it will blink.

DIOPTER ADJUSTMENT

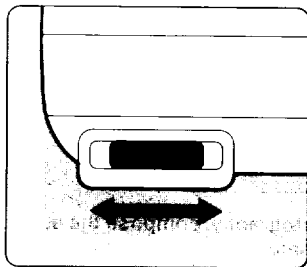

Aim the camera toward a bright subject. While looking through the viewfinder, move the diopter adjustment lever to the right or left until the AF frame appears in the sharpest focus.

FILM LOADING

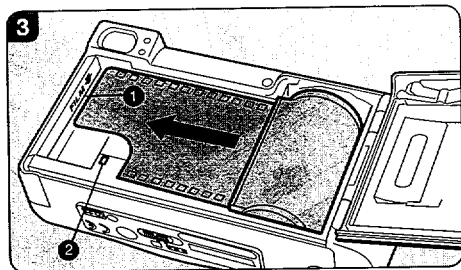
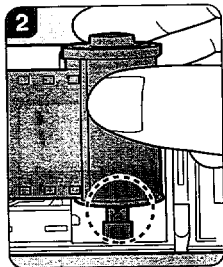
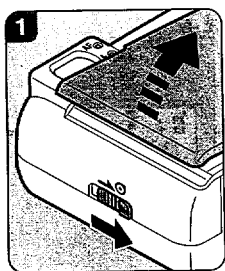

- 1 Slide the back cover release lever down and pull the back cover as illustrated.
- 2 Place the film cartridge in the film chamber by fitting the flat side onto the top of the rewind shaft first and then slide the top end of the film cartridge into the camera.
- 3 Pull the film leader out far enough from the cartridge to reach the take-up spool. Align the tip of the film with the film leader end mark ① and ensure the film is placed properly between the film guides.

Notes:

- If there is dirt on the film detector ②, film cannot be wound properly.
- Ensure the film is taut as illustrated on the illustration. Take up any slack in the film by pushing it back into the cartridge.

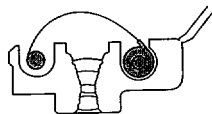

× Slack No!

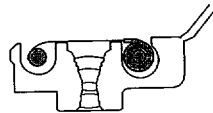

○ Flat Yes!

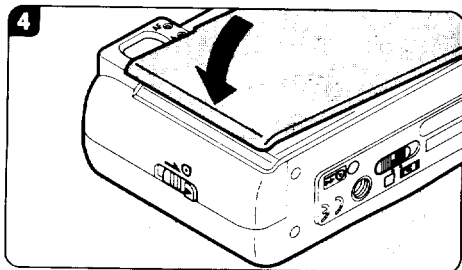

- 4 After the back cover is closed, the film automatically advances to the first frame.
- 5 When “1” appears in the exposure counter on the LCD panel, the film automatically stops winding.
- 6 If (E) blinks on the LCD panel, the film is not properly loaded. Reload the film.

- The exposure counter indication will remain on even if the main switch is turned OFF.

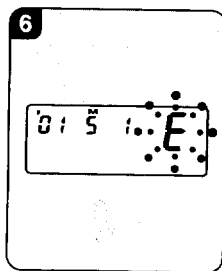
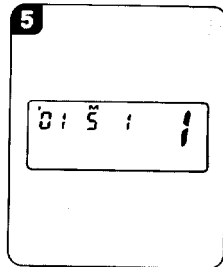

Automatic film speed setting

This camera is designed to use DX-coded films with ISO rating from 25 to 3200. When any of these films are loaded, the proper film speed is automatically set.

Note:

- Non-DX coded films should not be used. If Non-DX coded film is used, the film speed is automatically set to the ISO 25.

UNLOADING FILM

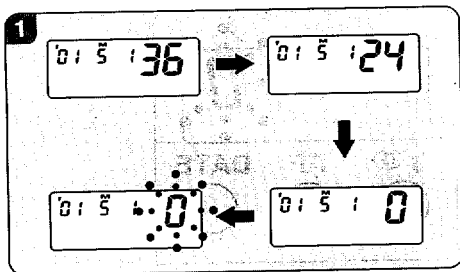

1 Rewinding the film

After you have exposed the last frame of the roll, the lens retracts to the shortest focal length and the film rewinds automatically, the motor stops, and (◻) blinks as shown to indicate that the film has been rewound.

- A 24-exposure roll of film takes about 25 seconds to be rewound.
- During rewinding, the exposure counter counts frame numbers in reverse.

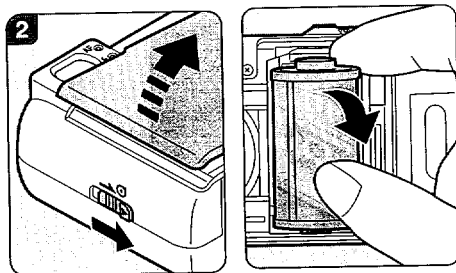

2 Unloading film

To unload the film, open the back cover, and remove the cartridge from the chamber by pulling the top of the film cartridge out first with your finger.

- Never open the back cover until the whole film roll is rewound.

REWINDING A FILM IN MID-ROLL

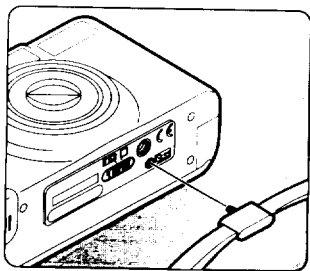

If you wish to unload a film before exposing all the frames, push the mid-roll rewind button with the protrusion part of the strap clamp; the lens retracts to the shortest focal length and then film rewinding starts.

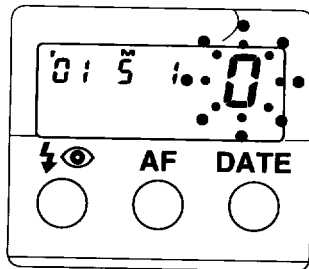

When rewind is completed, the motor stops, and (0) blinks, indicating that the back cover may be opened safely.

HOLDING THE CAMERA

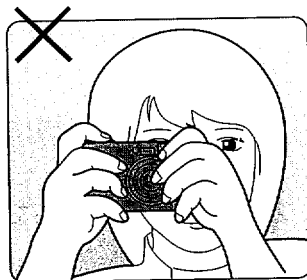
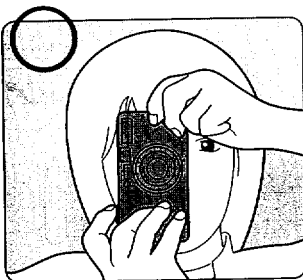
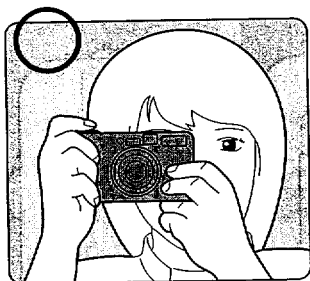

Keep the camera as still as possible, and gently depress the shutter release button. If too much force is applied, the camera is likely to shake, and the picture will be blurred. When using the flash with the camera positioned vertically, hold the camera so that the flash is above the lens.

Notes:

- Do not hold the zoom lens because it moves back and forth while in operation.
- Make sure not to obstruct the autofocus window, lens, light sensor window or the built-in flash with your fingers, hair or other object.

OPERATING THE ZOOM LENS

TAKING PHOTOGRAPHS

The standard format allows a shooting range from 0.5m (1.64ft) to ∞ (Infinity).

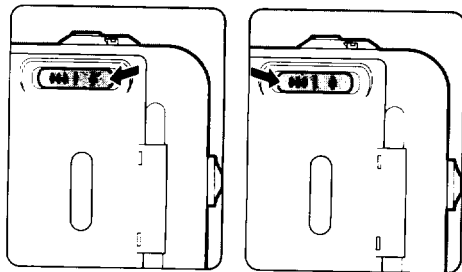

IQZoom 105SW 28 - 105mm

IQZoom 120SW 28 - 120mm

Pushing the zoom button on the right (\blacktriangleright) moves the lens towards the telephoto setting. Pushing the zoom button on the left (\blacktriangleleft) moves the lens towards the wide - angle setting. When the lens zooms to the desired setting, release the zoom button and depress the shutter release button fully to take pictures.

- Although a sound like the shutter closing may be heard accompanied by vibration while zooming, this is an operating sound that occurs due to switching of the internal mechanism of the lens and is not a malfunction.

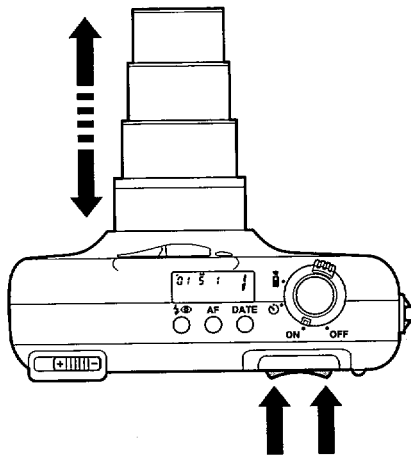

- Do not apply force to the zoom lens as doing so causes damage to the camera.
- The shutter cannot be released while the lens is zooming.

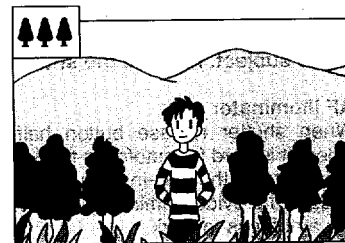
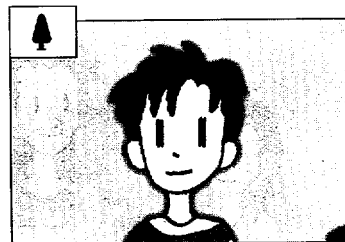

COMPOSING AND FOCUSING

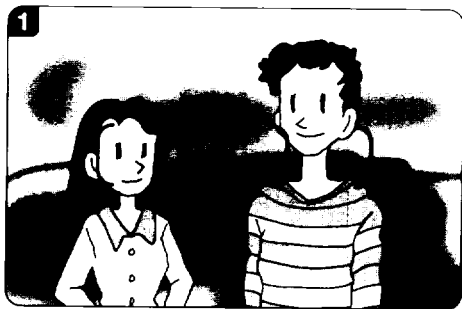

1 After zooming the lens, compose the scene, and place the autofocus frame on the subject. Release the shutter.

AF Illuminator

When shutter release button half way down where it is hard for autofocus to work, such as in a dark place, the built-in flash discharges continuously to provide illumination, making it easy for the autofocus to work.

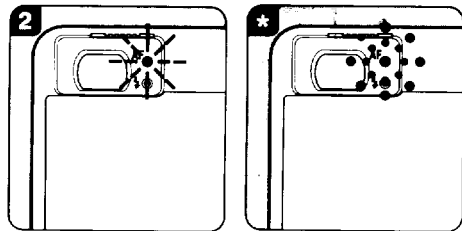

2 Check the lamp indication:
When the subject is in focus, the green lamp will light up.

- * The green lamp blinks if the subject is too close or if the subject is difficult to autofocus.
- * If the autofocus window is dirty, the autofocus may not function properly.

HARD-TO-AUTOFOCUS SUBJECTS

- a) Extremely low-contrast subjects such as a white wall or blue sky in the autofocus frame.
- b) Subjects which don't reflect much light in the autofocus frame.
- c) Fast moving subjects.
- d) Subjects with horizontal lines or complex or detailed patterns in the autofocus frame.
- e) Multiple subjects in foreground of the autofocus frame.
- f) Subjects positioned against reflected or strong backlight or with extremely bright background.

INFINITY-LANDSCAPE MODE

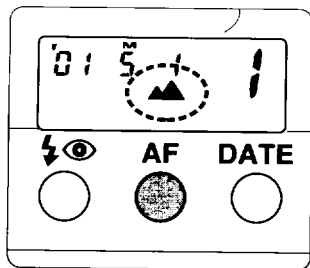

Use the Infinity-Landscape Mode to lock the focus at infinity or to take a picture of a distant scene through a window.

Depress the AF/Infinity-Landscape button repeatedly until (▲) appears on the LCD panel.

- After the picture is taken, this mode is canceled.
- The flash will not discharge in the auto exposure mode even in dark light situations.

SPOT FOCUS

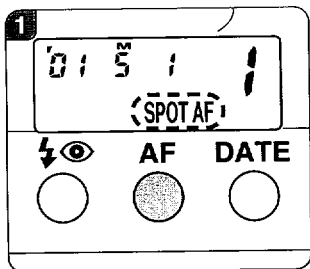

Select the Spot AF Mode to focus on a particular spot in the frame.

- 1 Depress the AF/Infinity-Landscape button so that the (SPOT AF) appears on the LCD panel.**

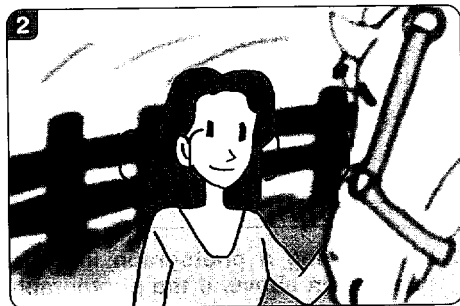

- 2 Focus on the subject with the Spot AF frame (()) in the center of the viewfinder.**

FOCUS-LOCK SHOOTING

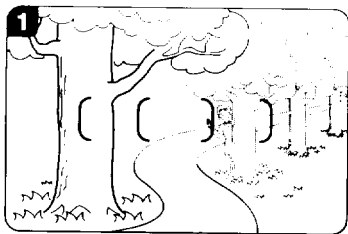

1 When taking a photograph like the one shown above, if the photograph is taken with the camera in this setting, the focus will be placed on the subject in the very front of the (()) and will not focus on the main subject in the back. In this case, use the Spot AF Mode and focus-lock technique.

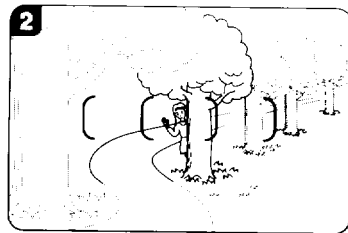

2 Focus on the subject with the Spot AF frame (()).

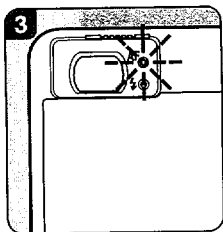

3 Depress the shutter release button halfway down. The green lamp in the viewfinder lights up and the exposure and focus are temporarily locked.

Note:

- The focus will not change as long as the green lamp is lit (Focus lock).

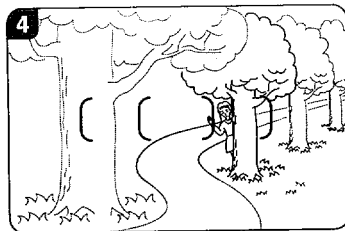

4 While holding the shutter release button halfway down, re-aim the camera or re-compose the picture, then press the release button all the way to release the shutter.

- You can release focus lock simply by lifting your finger from the shutter release button.

PANORAMA MODE

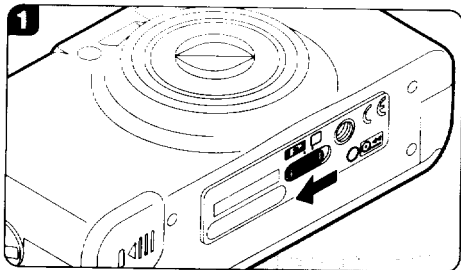

You can switch between the panorama format and standard format picture taking mode at any time by moving the panorama switch. The panorama format picture allows horizontally positioned dynamic pictures to be taken (approx. 13x36mm on film).

1 Move the panorama switch to (P) to select the panorama format mode.

- When the picture frame is switched to panorama, the viewfinder switches to the horizontal panorama format frame.

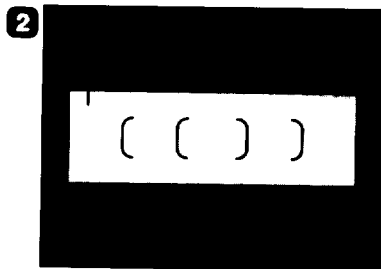

2 Compose the scene as you would normally and release the shutter.

- When the camera-to-subject distance is less than 1.2m (3.9ft), use of the panorama format is not recommended.
- Panorama format processing facilities differ depending on the area and requirements. Your local film processor or camera dealers will advise you on all the options to you.

AUTO EXPOSURE MODES

Automatic Flash Emission

The flash automatically discharges in low light or in a backlit conditions. When the shutter release button is pressed halfway down, the red lamp lights up indicating that the flash is ready. If the red lamp blinks, the built-in flash is being charged and the shutter cannot be released.

SELECT OTHER EXPOSURE MODES

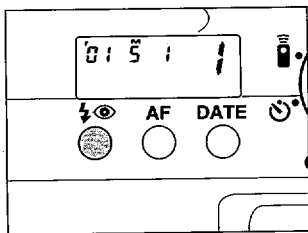

- For normal use, set the auto exposure mode.
- The camera is automatically re-set to the Auto Exposure Mode when the power is turned off.

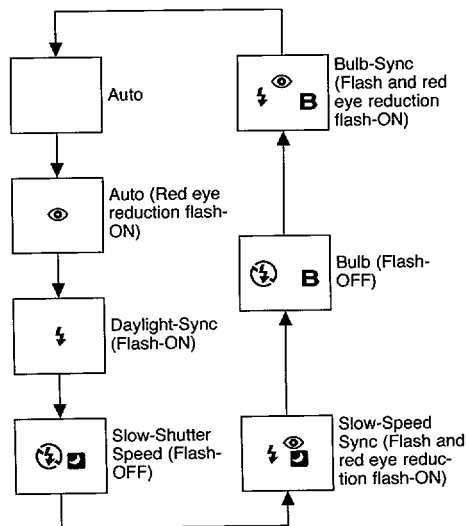

To select the various exposure modes, depress the mode button (⚡⊙).



FLASH EFFECTIVE RANGE (Color negative film)

IQZoom 105SW 28mm - 105mm

IQZoom 120SW 28mm - 120mm

Lens ISO	28mm meters 	105mm meters 	120mm meters 
25	0.5 - 1.6m (1.64 - 5.2ft)	0.5 - 0.9m (1.64 - 3ft)	0.5 - 0.8m (1.64 - 2.6ft)
50	0.5 - 2.3m (1.64 - 7.5ft)	0.5 - 1.3m (1.64 - 4.3ft)	0.5 - 1.1m (1.64 - 3.6ft)
100	0.5 - 3.3m (1.64 - 11ft)	0.5 - 1.8m (1.64 - 5.9ft)	0.5 - 1.6m (1.64 - 5.2ft)
200	0.5 - 4.6m (1.64 - 15ft)	0.5 - 2.5m (1.64 - 8.2ft)	0.5 - 2.2m (1.64 - 7.2ft)
400	0.59 - 6.6m (1.95 - 22ft)	0.5 - 3.6m (1.64 - 12ft)	0.5 - 3.2m (1.64 - 10ft)
800	0.84* - 9.3m (2.8* - 31ft)	0.5 - 5m (1.64 - 16ft)	0.5 - 4.5m (1.64 - 15ft)
1600	1.2* - 13.2m (3.9* - 43ft)	0.5 - 7.1m (1.64 - 23ft)	0.5 - 6.4m (1.64 - 21ft)
	1.7* - 18.6m (5.6* - 61ft)	0.5 - 10m (1.64 - 33ft)	0.5 - 9m (1.64 - 30ft)

* With high speed film, overexposure may occur at close range due to the film's high sensitivity.

Red-Eye Reduction Flash Function

To reduce the red-eye phenomenon in the picture, use this function. With this function used, the flash discharges two consecutive times to reduce the appearance of the red-eye effect.

DAYLIGHT-SYNC SHOOTING

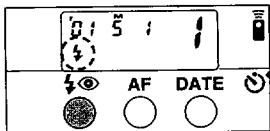

Daylight-Sync (Flash-ON)

Depress the mode button (⚡👁) until (⚡) appears on the LCD panel.

In this mode, the flash will always discharge in both dark and bright conditions. When a portrait is taken with the subject in a backlight situation, the front of the subject may be cast in shadow. In such a case, use the Daylight-Sync Shooting Mode (Flash-ON Mode) within the flash effective range to take a picture. This will ensure that a picture is well exposed without any shadow. When you wish to discharge the flash, use this mode.

Note:

- Make sure you're within the flash-effective range even when you use the built-in flash as a fill-in flash in daylight.

SLOW SHUTTER SPEEDS MODES

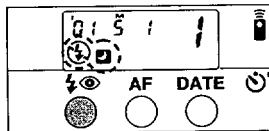

Slow Shutter Speed (Flash-OFF)

Depress the mode button (⚡👁) until (⚡🚫) appears on the LCD panel.

In this mode, the flash does not discharge, and a picture is taken at a slow shutter speed up to approx. 2 seconds. Use this mode in places where flash photography is prohibited or for a natural existing light effect in low ambient photography.

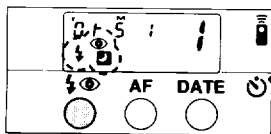

Slow-Speed-Sync Shooting (Flash and red eye reduction flash-ON)

Depress the mode button (⚡) until (⚡) appears on the LCD panel.

It is possible to photograph subjects and background in a balanced way by using the built-in flash to properly expose the foreground subject and a slow-speed to expose the low light background.

Notes:

- When shooting in low light, the shutter speed gets slower, and camera shake is likely to blur your picture. Use of a tripod is recommended.
- In all flash modes make sure you are within the flash-effective range.

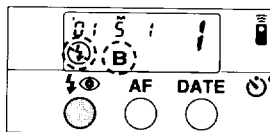

Bulb Mode (Flash-OFF)

Depress the mode button (⚡) until (ⓇB) appears on the LCD panel.

This mode is useful for long exposures required for shooting fireworks and night scenes. Use of a tripod is recommended.

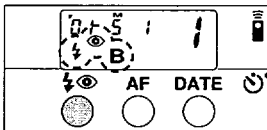

Bulb-Sync Mode (Flash and red eye reduction flash-ON)

Depress the mode button (⚡) until (⚡⊕B) appears on the LCD panel.

This lets you use the flash in addition to the Bulb Mode, so you can take a portrait photograph with a night scene in the background.

- In all flash modes make sure you are within the flash-effective range.
- The shutter remains open as long as the shutter release button held down. (Max. 1minute)
- Use of a tripod is recommended.

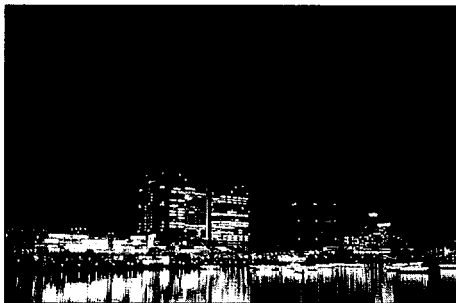

Bulb Mode, approx. 10 sec. (ISO 400)

SHOOTING MODES

To set various shooting modes, turn the main / drive switch.

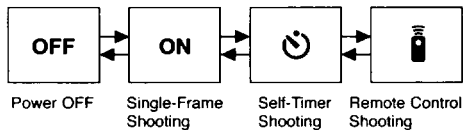

- For normal use, set the Single-Frame Shooting Mode.

To set various focusing modes, depress the AF/Infinity-Landscape button (AF).

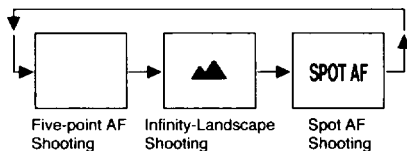

- For normal use, set the Five-point AF Shooting Mode.

SELF-TIMER PHOTOGRAPHY

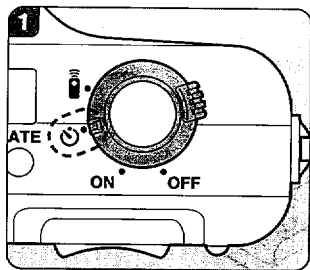

Self-Timer

Use the self-timer if you wish to get in the picture. Use of a tripod is recommended.

- 1 Set the main/drive switch to (☺).
- 2 Assure that the subject is within the AF frame in the viewfinder. Depress the shutter release button fully.

The shutter will be released in about 10 seconds. When the self-timer is working, the Self-Timer lamp blinks 3 seconds before the shutter is released.

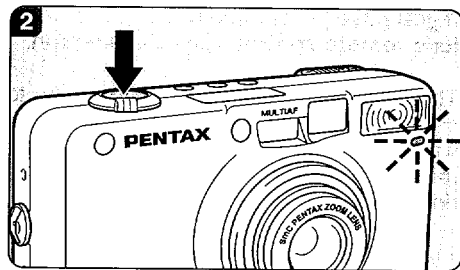

To cancel

To stop the self-timer operation at any time after it has been activated, set the main/drive switch to the other position.

- Do not stand directly in front of the camera when starting the Self-Timer, as the camera will focus on you, not the main subject. Be sure that you are behind, or next to the camera when starting the Self-Timer.
- When you want to use the flash with the self-timer, ensure that the red flash-ready lamp is lit before starting the self-timer.

USING WIRELESS REMOTE CONTROL (OPTIONAL)

If you have purchased the optional wireless remote control, read this section.

The wireless remote control allows you to trip the shutter at a distance. The shutter will be released 3 seconds after the shutter release button on the remote control is depressed.

- Use a tripod when shooting with the wireless remote control.
- Use the remote control to take pictures in the Bulb mode to avoid camera shake. While the remote control's shutter release button is held down, the shutter remains open up to a max. of 1 minutes.

Name of parts

Shutter release button

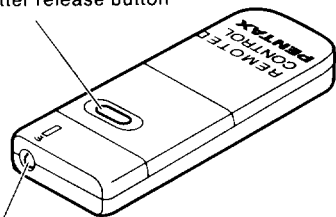

Remote control transmitter

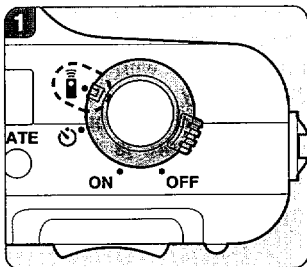

Remote Control Shooting Mode

1 Set the main/drive switch to ().

- If the shutter is released by the camera's release button, picture will be taken in the ordinary shooting mode.
- When the camera is set in the Remote Control Shooting Mode and left unused for 5 minutes, the lens automatically retracts and the power is switched OFF.

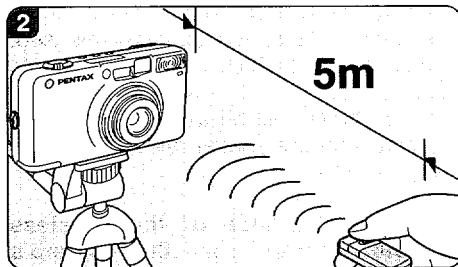

2 Compose the scene and frame the subject with the AF frame.

Aim the remote control transmitter towards the remote control receiver on the camera, and then depress the shutter release button on the remote control.

-
- The self-timer lamp blinks rapidly for 3 seconds and then the shutter is released.
 - Focus cannot be locked when the remote control is in use. The subject framed in the AF frame will be in focus when the remote control's shutter release button is depressed.

Operating Distance of the Wireless Remote Control from the camera's front: within approx. 5m (16ft) straight in front of the camera

- The remote control may not work in a backlight situation. In this case, use the camera's shutter release button in the Self-Timer Mode to take pictures.
- The remote control does not work while the flash is being charged.

Battery life on the Remote Control

About 30,000 commands can be issued using the Remote Control with a battery installed. If the battery is exhausted, please have it replaced at your local Pentax Service center (there is a charge for this service).

DATE MODE

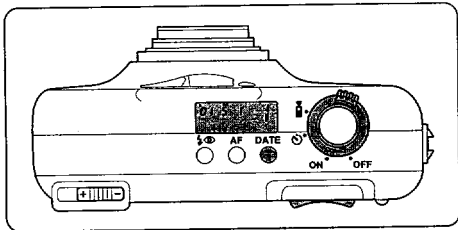

If you purchased the DATE model, read this section.

The dating unit automatically switches the DATE position between the standard and panorama according to the format mode selected.

- The DATE model records dates up to the year 2100 on pictures.
- Year 2001 will be imprinted ('01) on pictures.

Switching the Mode

Press the DATE button with your finger, the mode on the LCD panel switches as shown.

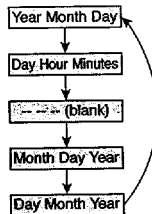

Notes:

- The data on the LCD panel will be imprinted on the film.
- "----" indicates no data will be imprinted.
- "M" on the LCD panel indicates "Month".

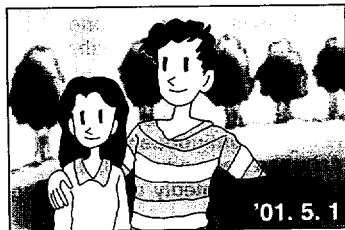

* The date in the picture above is simulated.

Correcting the date

Switch the power on.

1. Pressing the DATE button for 3 seconds: the "Year" digits and (MM) will blink.

2. Each time the DATE button is depressed, the blinking digits changes in the following manner:

Year - Month - Day - Hours - Minutes

Release the button when the desired digits appear.

3. Push the zoom button on the right or left side when you wish to change the blinking digits. The digits increase by one each time the right zoom button is pushed and the digits decrease by one each time the left zoom button is pushed. Pushing the zoom button for about one second will change the digits continuously.

4. After the data has been adjusted, depress the DATE button repeatedly until blinking stops.

- The blinking "minutes" allows precise fine-tuning of the internal clock to the beginning of a specified minute. When "minutes digits" are blinking, depress the DATE button in sync with a time signal.
- If you release the shutter while the blinking data is being corrected, the data will not be imprinted.
- If there is a white or yellow object in the corner of the picture where the data is imprinted, the data may be difficult to read. When composing your photographs, try to avoid brightly-colored subjects in that corner.

TROUBLESHOOTING

What appears troublesome may be easily remedied. Here are some problems that may occur and their remedies.

Symptoms	Causes and Remedies
1. The shutter cannot be released.	<ul style="list-style-type: none">• Is the main switch turned OFF? If so, turn it ON. See page 10.• Is the battery exhausted? Insert new battery. See page 9.• Is (Ⓜ) blinking on the LCD panel? The film has been used up. Insert a new roll. See page 13, 14.• Is (ⓔ) blinking on the LCD panel? The film has not been loaded properly. Reload the film. See page 14.
2. My printed pictures don't look very clear.	<ul style="list-style-type: none">• Did you position the autofocus frame on your subject? See page 20.• Did you obstruct the autofocus window with your fingers, hair or other object. See page 17.• Is the autofocus window dirty? Wipe it off. See page 20.
3. Zoom lens retracted automatically (the power is turned off automatically)	<ul style="list-style-type: none">• The lens automatically retracts to the shortest focal length if the camera is left unused for over 3 minutes. See page 10.• When the camera is set in the Remote Control shooting mode and left unused for 5 minutes, the lens automatically retracts and the power is switched OFF. See page 35.

Symptoms	Causes and Remedies
4. The Remote Control does not operate.	<ul style="list-style-type: none"> • The operable distance of the Remote Control is approx. 5m from the front. See page 36. • The Remote Control may not operate in a backlit situation. See page 36. • The flash is being charged. Wait until it fully charges. See page 36. • Is the battery for the remote control exhausted? See page 36.
5. The flash discharges, though it is not dark.	<ul style="list-style-type: none"> • The flash discharges automatically in a backlit situation. See page 27. • Daylight sync mode has been set. See page 29.

SPECIFICATIONS

- Type:** _____ 35mm fully automatic lens-shutter with built-in zoom lens and auto flash
- Film:** _____ Auto film speed setting with 35mm perforated DX - coded film with ISO rating from 25 - 3200 (1EV step). Non - DX coded films are automatically set to ISO25
- Format:** _____ 24x36mm (Approx. 13 x 36 in panorama format)
- Film loading:** _____ Auto film loading. Closing the back cover will automatically wind the film to first exposure.
- Film winding:** _____ Auto film winding (single - frame)
- Film rewinding:** _____ Auto film rewinding at the end of roll. Auto stop upon completion of rewinding. Rewinding time: approx. 25sec. with 24 - exposure film. Rewinding in mid - roll provided.
- Frame number:** _____ Automatic readout of successive frame numbers in ascending order when shooting, and descending order when rewinding.
- Lens:**
- IQZoom 105SW** _____ Pentax power zoom 28 - 105mmf/5.6 - 11.5
6 elements in 5 groups, Angle of view: 75.5° - 23.3°
- IQZoom 120SW** _____ Pentax power zoom 28 - 120mmf/5.6 - 12.8
6 elements in 5 groups, Angle of view: 75.5° - 20.5°
- Focusing system:**
- IQZoom 105SW** _____ Pentax phase-matching passive five-point autofocus system. Autofocusing range: 0.5m (1.64 ft) - infinity, Maximum magnification: approx.0.27X. Focus lock is provided. Infinity-landscape mode (focus is fixed to infinity), AF illuminator is automatically emitted in low light/ or hard-to-autofocus subject.
- IQZoom 120SW** _____ Pentax phase-matching passive five-point autofocus system. Autofocusing range: 0.5m (1.64ft) - infinity, Maximum magnification: approx.0.32X . Focus lock is provided. Infinity-landscape mode (focus is fixed to infinity), AF illuminator is automatically emitted in low light/ or hard-to-autofocus subject.
- Zooming:** _____ Electronic zoom
- Shutter:** _____ Programmed AE electronic shutter with speed approx.1/360 - 2 sec. Bulb: 1/2 sec.- 1min, Electromagnetic release.

Self-timer: ————— Electronic lamp indication. Approx. 10 sec. Cancellation after activation is possible.

Viewfinder:

IQZoom 105SW ————— Standard/panorama switchable. Actual image zoom viewfinder, Viewfinder area: 83%, Magnification: 0.32X (28mm WIDE) – 1.13X (105mm TELE), Diopter adjustment range: -3 to +1m⁻¹, Five-point AF frames for Wide-angle and Telephoto settings, Spot AF frame, Picture frame, Close distance compensation frame, Panorama format picture area, Green lamp lighting: in-focus signal Green lamp blinking: When subject is too close and/or hard-to-autofocus subject, Red lamp lighting: Flash-ready status, Red lamp blinking: Flash being charged

IQZoom 120SW ————— Standard/panorama switchable. Actual image zoom viewfinder, Viewfinder area: 83%, Magnification: 0.32X (28mm WIDE) – 1.26X (120mm TELE), Diopter adjustment range: -3 to +1m⁻¹, Five-point AF frames for Wide-angle and Telephoto settings, Spot AF frame, Picture frame, Close distance compensation frame, Panorama format picture area, Green lamp lighting: in-focus signal Green lamp blinking: When subject is too close and/or hard-to-autofocus subject, Red lamp lighting: Flash-ready status, Red lamp blinking: Flash being charged

Exposure control:

IQZoom 105SW ————— Programmed auto-exposure control with multi segment (2) metering system, Range: EV10 – EV17 at 28mm WIDE, EV13 – EV19 at 105mm TELE in Auto or Daylight-Sync Mode (ISO 400), EV6 – EV17 at 28mm WIDE EV6 – EV19 at 105mm in Slow-Shutter-Speed Mode (ISO 400), Automatic exposure compensation in a backlit situation.

IQZoom 120SW ————— Programmed auto-exposure control with multi segment (2) metering system, Range: EV10 – EV17 at 28mm WIDE, EV13.5 – EV19 at 120mm TELE in Auto or Daylight-Sync Mode (ISO 400), EV6 – EV17 at 28mm WIDE EV6 – EV19 at 120mm in Slow-Shutter-Speed Mode (ISO 400), Automatic exposure compensation in a backlit situation.

Flash: ————— Built-in flash with red-eye reduction mode, Automatic discharge in low lighting and backlighting situations in auto mode, Flash ON=Day-light Sync/Slow-Shutter-Speed Sync (up to 2 sec.), Flash - OFF Mode, Bulb-Sync 1/2 sec. - 1min.

Flash effective range:

IQZoom 105SW ————— 0.59 (1.95ft) – 6.6 (22ft) m (28mm WIDE), 0.5 (1.64ft) – 3.6m (12ft) (105mm TELE) (ISO 400 film used).

IQZoom 120SW ————— 0.59 (1.95ft) – 6.6 (22ft) m (28mm WIDE), 0.5 (1.64ft) – 3.2m (10ft) (120mm TELE) (ISO 400 film used).

Flash recycling time: — Approx. 5 sec. under Pentax testing conditions.

Power source — One 3V lithium battery (CR - 2 or the equivalent)

Battery life: — Approx. 8 rolls of 24 exposure film when 50% of shooting uses flash (under Pentax testing conditions)

Battery exhaustion warning: — (\square) appears on the LCD panel, Shutter is locked when (\square) is blinking.

Size & Weight:

IQZoom 105SW — 111 (W) x 59.5 (H) x 41 (D) mm (4.4" x 2.3" x 1.6") 190g (6.7oz) without battery

IQZoom 120SW — 111 (W) x 59.5 (H) x 41 (D) mm (4.4" x 2.3" x 1.6") 190g (6.7oz) without battery

DATE MODEL

Date mechanism: — Crystal quartz controlled; LCD with digital clock, auto calendar up to 2100. Possible to imprint both standard and panoramic format frames.

Imprinting mode: — "Year, Month and Day", "Day, Hour and Minutes, "----" blank, Month, Day and Year" or "Day, Month and Year".

Size & Weight:

IQZoom 105SW — 111 (W) x 59.5 (H) x 41 (D) mm (4.4" x 2.3" x 1.6") 190g (6.7oz) without battery

IQZoom 120SW — 111 (W) x 59.5 (H) x 41 (D) mm (4.4" x 2.3" x 1.6") 190g (6.7oz) without battery

REMOTE CONTROL

Remote control: — Infrared wireless remote control, 3-seconds delay shutter release, Effective range: Closer than 5m when projected from the camera's front.

Power source for Remote Control: — One lithium battery CR1620 (replaced by Pentax Service facility)

Size & weight for Remote Control:

— 22.0 (W) x 53.0 (L) x 6.5 (D) mm (0.9" x 2.1" X0.3"), 7g (0.2oz) including battery

SPECIFICATIONS ARE SUBJECT TO CHANGE AT ANY TIME WITHOUT NOTIFICATION OR ANY OBLIGATION ON THE PART OF THE MANUFACTURER.

WARRANTY POLICY

All Pentax cameras purchased through authorized bona fide photographic distribution channels are guaranteed against defects of material or workmanship for a period of twelve months from date of purchase. Service will be rendered, and defective parts will be replaced without cost to you within that period, provided the equipment does not show evidence of impact, sand or liquid damage, mishandling, tampering, battery or chemical corrosion, operation contrary to operating instructions, or modification by an unauthorized repair shop. The manufacturer or its authorized representatives shall not be liable for any repair or alterations except those made with its written consent and shall not be liable for damages from delay or loss of use or from other indirect or consequential damages of any kind, whether caused by defective material or workmanship or otherwise; and it is expressly agreed that the liability of the manufacturer or its representatives under all guarantees or warranties, whether expressed or implied, is strictly limited to the replacement of parts as herein before provided. No refunds will be made on repairs performed by non-authorized Pentax service facilities.

Procedure During 12-month Warranty Period

Any Pentax which proves defective during the 12 month warranty period should be returned to the dealer from whom you purchased the equipment or to the manufacturer. If there is no representative of the manufacturer in your country, send the equipment to the manufacturer with postage prepaid. In this case, it will take a considerable length of time before the equipment can be returned to you owing to the complicated customs procedures required. If the equipment is covered by warranty, repairs will be made and parts replaced free of charge, and the equipment will be returned to you upon completion of servicing. If the equipment is not covered by warranty, regular charges of the manufacturer or of its representatives will apply. Shipping charges are to be borne by the owner. If your Pentax was purchased outside of the country where you wish to have it serviced during the warranty period, regular handling and servicing fees may be charged by the manufacturer's representatives in that country. Notwithstanding this, your Pentax returned to the manufacturer will be serviced free of charge according to this procedure and warranty policy.

In any case, however, shipping charges and customs clearance fees are to be borne by the sender. To prove the date of your purchase when required, please keep the receipts or bills covering the purchase of your equipment for at least a year. Before sending your equipment for servicing, please make sure that you are sending it to the manufacture's authorized representatives or their approved repair shops, unless you are sending it directly to the manufacturer. Always obtain a quotation for the service charge, and only after you accept the quoted service charge, instruct the service station to proceed with the servicing.

This warranty does not apply to Pentax products purchased in the United States. Therefore, for warranty information regarding Pentax products purchased in the United States, please read the warranty card supplied with your product.



The CE mark is Directive conformity mark of the European Community (EC).

STATEMENT OF FCC COMPLIANCE

This device complies with Part 15 of the FCC Rules. Operation is subject to the following two conditions: (1) This device may not cause harmful interference, and (2) this device must accept any interference received, including interference that may cause undesired operation.

Changes or modifications not approved by the party responsible for compliance could void the user's authority to operate the equipment.

This equipment has been tested and found to comply with the limits for a Class B digital device, pursuant to part 15 of the FCC Rules. These limits are designed to provide reasonable protection against harmful interference in a residential installation. This equipment generates, uses and can radiate frequency energy and, if not installed and used in accordance with the instructions, may cause harmful interference to radio communications. However, there is no guarantee that interference will not occur in a particular installation. If this equipment does cause harmful interference to radio or television reception, which can be determined by turning the equipment off and on, the user is encourage to try to correct the interference by one or more of the following measures:

- Reorient or relocate the receiving antenna.
- Increase the separation between the equipment and receiver.
- Consult the dealer or an experience radio/TV technician for help.



Asahi Optical Co., Ltd. 2-36-9, Maeno-cho, Itabashi-ku, Tokyo 174-8639, JAPAN (<http://www.pentax.co.jp>)

Pentax GmbH (European Headquarters) Julius-Vosseler-Strasse, 104, 22527 Hamburg, GERMANY
(HQ - <http://www.pentaxeuropa.com> Germany - <http://www.pentax.de>)

Pentax U.K. Limited Pentax House, Heron drive, Langley, Slough, Berks SL3 8PN, U.K. (<http://www.pentax.co.uk>)

Pentax France S.A. 12/14, rue Jean Poulmarch, 95106 Argenteuil Cedex, FRANCE

Pentax Benelux B.V. (for Netherlands) Spinveld 25, 4815 HR Breda, NETHERLANDS (<http://www.pentax.nl>)
(for Belgium & Luxembourg) Weiveldlaan 3-5, 1930 Zaventem, BELGIUM (<http://www.pentax.be>)

Pentax (Schweiz) AG Widenholzstrasse 1 Postfach 367 8305 Dietlikon, SWITZERLAND (<http://www.pentax.ch>)

Pentax Scandinavia AB P.O. Box 650, 75127 Uppsala, SWEDEN (<http://www.pentax.se>)

Pentax Europe n.v. (European Distribution Center) Weiveldlaan 3-5, 1930 Zaventem, BELGIUM

Pentax Corporation 35 Inverness Drive East, Englewood, Colorado 80112, U.S.A. (<http://www.pentax.com>)

Pentax Canada Inc. 3131 Universal Drive, Mississauga, Ontario L4X 2E5, CANADA (<http://www.pentaxcanada.ca>)