

USER MANUAL

MODEL 285 and 285S

RS-232 to RS-485
Interface Converters

Revision C and above



PE PATTON
Electronics Co.

Part# 07M285-B
Doc# 047012UB
Revised 9/29/93

SALES OFFICE
(301) 975-1000
TECHNICAL SUPPORT
(301) 975-1007
<http://www.patton.com>

1.0 WARRANTY INFORMATION

Patton Electronics warrants all Model 285 components to be free from defects, and will—at our option—repair or replace the product should it fail within one year from the first date of shipment.

This warranty is limited to defects in workmanship or materials, and does not cover customer damage, abuse, or unauthorized modification. If this product fails or does not perform as warranted, your sole recourse shall be repair or replacement as described above. Under no condition shall **Patton Electronics** be liable for any damages incurred by the use of this product. These damages include, but are not limited to, the following: lost profits, lost savings, and incidental or consequential damages arising from the use of or inability to use this product. **Patton Electronics** specifically disclaims all other warranties, expressed or implied, and the installation or use of this product shall be deemed an acceptance of these terms by the user.

1.1 RADIO AND TV INTERFERENCE

The Model 285 generates and uses radio frequency energy, and if not installed and used properly—that is, in strict accordance with the manufacturer's instructions—may cause interference to radio and television reception. The Model 285 has been tested and found to comply with the limits for a Class A computing device in accordance with the specifications in Subpart J of Part 15 of FCC rules, which are designed to provide reasonable protection from such interference in a commercial installation. However, there is no guarantee that interference will not occur in a particular installation. If the Model 285 does cause interference to radio or television reception, which can be determined by disconnecting the RS-232 interface, the user is encouraged to try to correct the interference by one or more of the following measures: moving the computing equipment away from the receiver, re-orienting the receiving antenna, and/or plugging the receiving equipment into a different AC outlet (such that the computing equipment and receiver are on different branches).

1.2 SERVICE

All warranty and non-warranty repairs must be returned freight prepaid and insured to Patton Electronics. All returns must have a Return Materials Authorization number on the outside of the shipping container. This number may be obtained from Patton Electronics Technical Service at **(301) 975-1007**. *Packages received without an RMA number will not be accepted.*

Patton Electronics' technical staff is also available to answer any questions that might arise concerning the installation or use of your Model 285. Technical Service hours: **8AM to 5PM EST, Monday through Friday.**

2.0 GENERAL INFORMATION

Thank you for your purchase of this Patton Electronics product. This product has been thoroughly inspected and tested and is warranted for One Year parts and labor. If any questions or problems arise during installation or use of this product, please do not hesitate to contact Patton Electronics Technical Support at (301) 975-1007.

2.1 FEATURES

- Bi-directionally converts RS-232 signals to balanced RS-485
- Supports up to 50 multipoint device drops in a polling environment
- Supports data rates to 115.2 Kbps on 2 or 4 wires
- Passes transmit & receive data, one control signal each direction
- DTE/DCE switch selectable on RS-232 interface
- Interface powered—no AC power or batteries are required
- Variable high/low impedance settings
- Carrier can be set as "constantly on" or "controlled by RTS"

2.2 DESCRIPTION

Communicate between RS-485 devices and RS-232C using the Patton Electronics Model 285 Interface Converter. The Model 285 converts RS-232C signals into balanced RS-485 signals over one or two twisted pair. Drawing all necessary operating power from the RS-232 interface, the Model 285 needs no AC power or batteries.

The Model 285 has six convenient configuration switches to adapt the unit for DCE or DTE, 2 or 4 wire, full or half duplex, and point-to-point or multi-point applications. The Model 285 will support up to 50 polled devices without distance degradation.

The surge protected Model 285S uses high speed avalanche diodes to clamp voltage surges caused by lightning, motors, switches, etc. With surge handling capacity of 600W per wire at 1mS, the 285S has the ability to protect itself and connected equipment from common damaging surges.

Connector options to the RS-485 are via DB-25 (employing the RS-530 interface), RJ-11, RJ-45, or terminal blocks with strain relief.

3.0 CONFIGURATION

The Model 285 is configured using six PC board mounted switches. Figure 1 (below) shows the switch locations, along with the location of the terminal blocks and optional surge protectors:

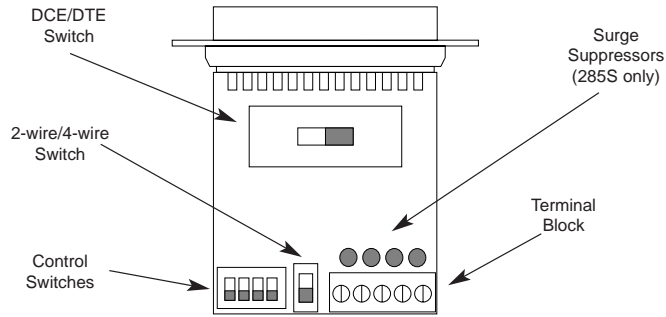

Figure 1. Model 285 board, showing switch locations

3.1 SETTING THE DTE/DCE SWITCH

For your convenience, the Model 285 has an externally accessible DTE/DCE switch (see Figure 2, below). If the device connected to the Model 285 is a modem or multiplexer (or is wired like one), set the switch to "DTE". This setting causes the Model 285 to behave like Data Terminal Equipment and transmit data on pin 2.

If the device connected to the Model 285 is a PC, terminal or host computer (or is wired like one), set the switch to "DCE". This setting causes the Model 285 to behave like Data Communications Equipment and transmit data on pin 3.

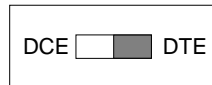

Figure 2. Close up of external DCE/DTE switch

3.2 SETTING CONFIGURATION SWITCHES SW1 AND SW2

The five switches shown in Figure 3 (below) configure the Model 285 for RTS/CTS delay, echo, method of carrier control, impedance, and 2-wire/4-wire operation. These switches are located *internally* on the Model 285's PC board. To access SW1 and SW2, use a small flat blade screw driver to pop open the Model 285's case as shown in Figure 4 (below):

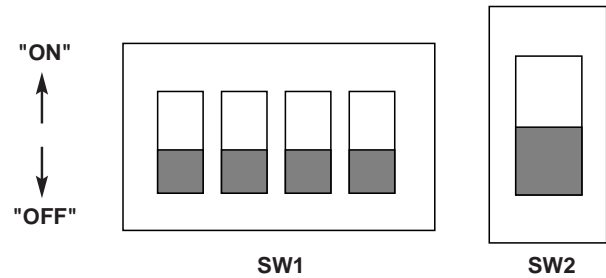

Figure 3. Close up of switches SW1 and SW2 on the PC board

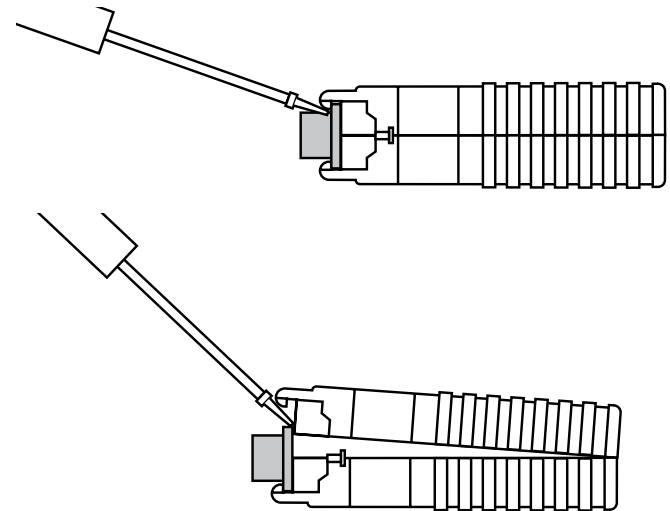

Figure 4. Opening the Model 285's plastic case with a small screw driver

3.2.1 CONFIGURATION SWITCH FUNCTIONS

The table and descriptions below detail the functions of the five configuration switches. Read this information carefully before setting the switches.

SWITCH SUMMARY TABLE			
Position	Function	Off Position	On Position
SW1-1	RTS/CTS Delay	0 mSec	8 mSec
SW1-2	Echo Enable	Echo "Off"	Echo "On"
SW1-3	Carrier Control	Constantly "On"	Controlled by RTS
SW1-4	Impedance	High (120K Ohm)	Low (120 Ohm)
SW2	2 wire/4 wire	2-wire	4-wire

SW1-1: RTS/CTS Delay: Switch 1-1 determines how long circuit CB (CTS) takes to become active after RTS is asserted (DCE Mode only). RTS delay of 8 mSec will give any signal from any other device time to clear the transmit line. In DTE mode, CTS is open.

SW1-2: Echo Enable: With Switch 1-2 in the ON position, the 285 echoes transmitted data back to the transmitting device. This is so the user can see what is being transmitting to the remote device. (Typically used in half duplex modes only).

SW1-3: Carrier: With Switch 1-3 in the ON position, the 285 transmitter operation follows circuit CA (Request to Send). When RTS is low, the 285 transmitter operation is off (0V) (DCE mode only).

SW1-4: Impedance: Switch 1-4 defines a termination resistance. The 285 transmitter can drive 50 unit loads including two termination resistances of 120 Ohms each.

SW2: 2 Wire/ 4 Wire: Switch 2 determines 2 wire (half duplex) or 4 wire operation.

3.2.2 CONFIGURATION SWITCH APPLICATIONS

The table below shows you how to set the Model 285's configuration switches to fit several common applications. If you have any questions about the proper settings for your application, call Patton Technical Support at (301) 975-1007.

TYPICAL SWITCH APPLICATIONS					
Switch Settings	Point-to-Point			Multi-point	
	4W	4W HDX	2W	4W	2W
RTS/CTS (SW1-1)*	ON	ON	ON	ON	ON
Echo (SW1-2)	OFF	ON	OFF	ON	OFF
Carrier (SW1-3)	OFF	ON	ON	Master-OFF Slaves-ON	ON
Impedance (SW1-4)	ON	ON	ON	Master - ON Slaves - HIGH Last Slave - ON	
2wire/4wire (SW2)	ON	ON	OFF	ON	OFF

*NOTE: RTS/CTS Delay (SW1-1) setting should be based upon transmission timing.

3.2.3 WHEN YOU'RE FINISHED CONFIGURING...

Once you've finished setting the Model 285's configuration switches, *pause* before you snap the case halves back together. If you are connecting the RS-485 interface using the internal terminal blocks, go to Section 4.1.3 and continue the installation procedure. If you are connecting the RS-485 interface using RS-11, RS-45 or DB-25, go ahead and snap the case halves back together now (don't force a fit—make sure all the pieces are properly set before snapping the case halves shut).

4.0 INSTALLATION

Once you have properly set the configuration switches, you are ready to connect the Model 285 to your system. This section tells you how to properly connect the Model 285 to the RS-485 and RS-232 interfaces, and how to operate the Model 285.

4.1 CONNECTION TO THE RS-485 INTERFACE

To function properly, the Model 285 *must* have one or two twisted pairs of metallic wire. These pairs must be "dry" (unconditioned) metallic wire, between 19 and 26 AWG (the higher number gauges may limit distance somewhat).

For your convenience, the Model 285 is available with several different physical interfaces on the RS-485 side: DB-25 (following the RS-520 standard), RJ-11 jack, RJ-45 jack, and terminal blocks with strain relief.

4.1.1 4-WIRE CONNECTION USING THE DB-25

The DB-25 connector on the Model 285's RS-485 side conforms to the RS-530 interface standard. When connecting to an RS-485 device that also conforms to the RS-530 standard, your cable should be "crossed over" in the manner shown below:

MODEL 285		RS-485 (530) DEVICE	
SIGNAL	DB-25 PIN	DB-25 PIN	SIGNAL
XMT+	2.....	3	RCV+
XMT-	14.....	16	RCV-
RCV+	3.....	2	XMT+
RCV-	16.....	14	XMT-

NOTE: It is not necessary that the RS-485 device adhere to the RS-530 standard. However, you must make sure that the signals, polarities, and pairing of your connection conform to the above diagram.

4.1.2 4-WIRE CONNECTION USING RJ-11 OR RJ-45

The RJ-11 and RJ-45 connectors on the Model 285's RS-485 side are pre-wired for a standard TELCO wiring environment. The signal/pin relationships are shown below:

RJ-11	SIGNAL	RJ-45	SIGNAL
1.....	GND*	1.....	N/C
2.....	RCV-	2.....	GND*
3.....	XMT+	3.....	RCV-
4.....	XMT-	4.....	XMT+
5.....	RCV+	5.....	XMT-
6.....	GND	6.....	RCV+
		7.....	GND
		8.....	N/C

In most modular RS-485 applications it is necessary to use a "cross over" cable. The diagram below shows how a cross over cable should be constructed for an environment where both the Model 285 and the RS-485 device use a 6-wire RJ-11 connector. Similar logic should be followed when using RJ-45 connectors or a combination of the two.

MODEL 285		RS-485 DEVICE	
SIGNAL	PIN#	PIN#	422 SIGNAL
GND*	14	XMT-
RCV-	25	RCV+
XMT+	32	RCV-
XMT-	43	XMT+
RCV+	5		
GND	6		

*Connection to ground is optional

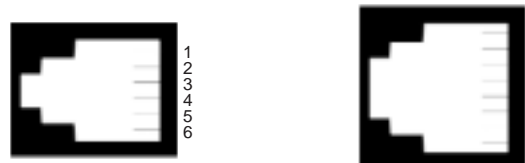

**Standard AT&T pin assignments - yours may be different.

4.1.3 4-WIRE CONNECTION USING TERMINAL BLOCKS

If your RS-485 application requires you to connect two pairs of bare wires to the Model 285, you will need to open the case to access the terminal blocks. The following instructions will tell you how to open the case, connect the bare wires to the terminal blocks, and fasten the strain relief collar in place so that the wires won't pull loose.

1. You should already have the case open for the configuration procedure. If not, open the case according to the diagram in Section 3.2.

2. Strip the outer insulation from the twisted pairs about one inch from the end.

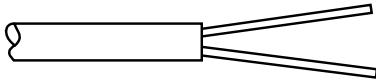

3. Strip back the insulation on each of the 2 twisted pair wires about .25".

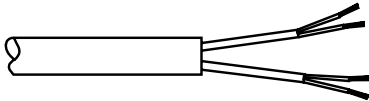

4. Connect *one pair* of wires to XMT+ and XMT- (transmit positive and negative) on the terminal block, making careful note of which color is positive, and which color is negative.

5. Connect the *other pair* of wires to RCV+ and RCV- (receive positive and negative) on the terminal block, again making careful note of which color is positive, and which color is negative.

Ultimately, you will want to construct a two pair cross over cable that makes a connection with the RS-485 device as shown below:

<u>Model 285</u>	<u>RS-485 Device</u>
XMT+.....	RCV+
XMT-.....	RCV-
RCV+.....	XMT+
RCV-.....	XMT-

6. If there is a shield around the telephone cable, it may be connected to "G" on the terminal block. We recommend connecting the shield at the computer end only to avoid ground loops. A ground wire is *not necessary* for proper operation of the Model 285.

7. When you finish connecting the wires to the terminal block, the assembly should resemble the diagram below:

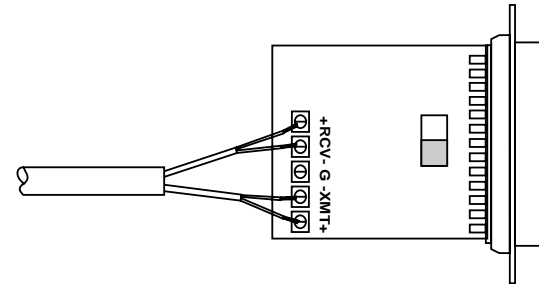

8. Place the 2 halves of the strain relief assembly on either side of the telephone wire and press together very lightly. Slide the assembly so that it is about 2 inches from the terminal posts and press together firmly. If your cable diameter is too small or too large for our strain relief, please contact our technical support. We have strain relief assemblies to accommodate most cable diameters.

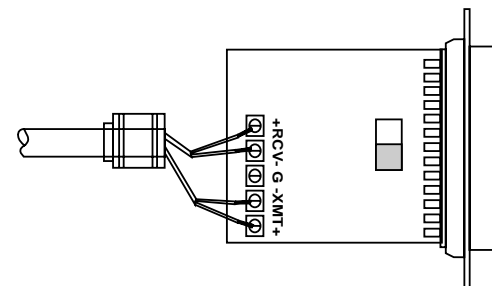

(continued)

9. Insert the strain relief assembly with the wire going through it into the slot in the bottom half of the modem case and set it into the recess in the case.

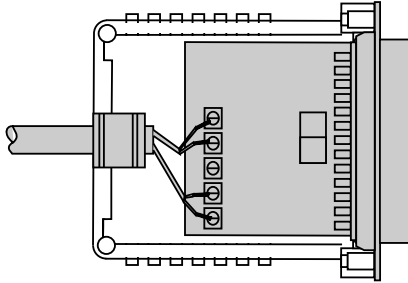

10. BEND the top half of the case as necessary to place it over the strain relief assembly. Do not snap the case together yet.

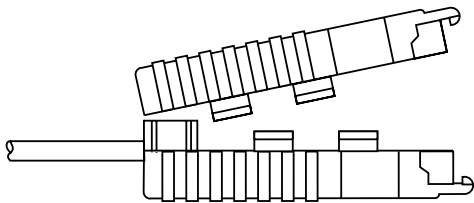

11. Insert one captive screw through a saddle washer and then insert the captive screw with the washer on it, through the hole in the DB-25 end of the case. Snap that side of the case closed. Repeat the process for the other side. This completes the cable installation process.

4.1.4 2-WIRE CONNECTION

Most RS-485 devices employ a two-wire, half duplex configuration. When using this configuration, be sure to first set the Model 285 to "two wire" mode—then use *only the transmit (XMT) pair* as shown below:

<u>285 SIGNAL</u>	<u>RS-485 SIGNAL</u>
XMT+	+
XMT-	-

The above wiring pattern applies regardless of whether you are making the RS-485 connection via DB-25, RJ-11, RJ-45 or terminal blocks. For specific wiring instructions, please refer to the previous pages of Section 4.

4.2 CONNECTION TO THE RS-232 INTERFACE

Once you have properly configured the Model 285 and connected the twisted pair wires correctly, all that remains is to plug the 285 directly into the DB-25 port of the RS-232 device. After doing so, remember to insert and tighten the two captive connector screws.

(Note: If you must use a cable to connect the Model 285 to the RS-232 device, make sure it is a *straight through* cable of the shortest possible length—we recommend 6 feet or less).

4.3 OPERATING THE MODEL 285

Once the Model 285 is properly installed, it should operate transparently—as if it were a standard cable connection. Operating power is derived from the RS-232 data and control signals; there is no "ON/OFF" switch. All data signals from the RS-232 and RS-485 interfaces are passed straight through. Additionally, one hardware flow control signal is passed *in each direction*.

**APPENDIX A
SPECIFICATIONS**

Transmission Format: Asynchronous

Data Rate: Up to 115,200 bps

Transmit Line: 2, 4 wire unconditioned twisted pair

Transmit Mode: Full or half duplex

Transmit Level: 0 dBm

Range: Up to 9 miles

Control Signals: DSR turns "ON" immediately after the terminal raises DTR; DCD turns "ON" after recognizing the receive signal from the line; CTS turns on after the terminal raises RTS

Carrier: The carrier is strap selected either continuous operation or switched operation, controlled by RTS

Surge Protection: 600W power dissipation at 1 mS and response time less than 1.0 pS

Power: None required, uses ultra low power from EIA data and control signals

Size: 2.66" x 2.10" x 0.73"

**APPENDIX B
RS-232C PIN CONFIGURATIONS**

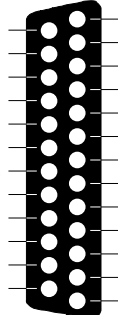
DIRECTION	STANDARD "DCE" SETTING	DIRECTION
To Model 285	 <p>1- (FG) Frame Ground 2- (TD) Transmit Data 3- (RD) Receive Data 4- (RTS) Request to Send 5- (CTS) Clear to Send 6- (DSR) Data Set Ready 7- (SG) Signal Ground 8- (DCD) Data Carrier Detect</p>	To Model 285 From Model 285 To Model 285 From Model 285 From Model 285 From Model 285

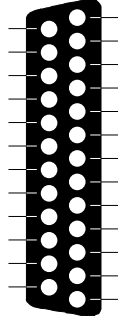
DIRECTION	STANDARD "DTE" SETTING	DIRECTION
From Model 285	 <p>1- (FG) Frame Ground 2- (TD) Transmit Data 3- (RD) Receive Data 4- (RTS) Request to Send 5- (CTS) Clear to Send 6- (DSR) Data Set Ready 7- (SG) Signal Ground 8- (DCD) Data Carrier Detect</p>	From Model 285 To Model 285 From Model 285 To Model 285 To Model 285 To Model 285

APPENDIX C
BLOCK DIAGRAM

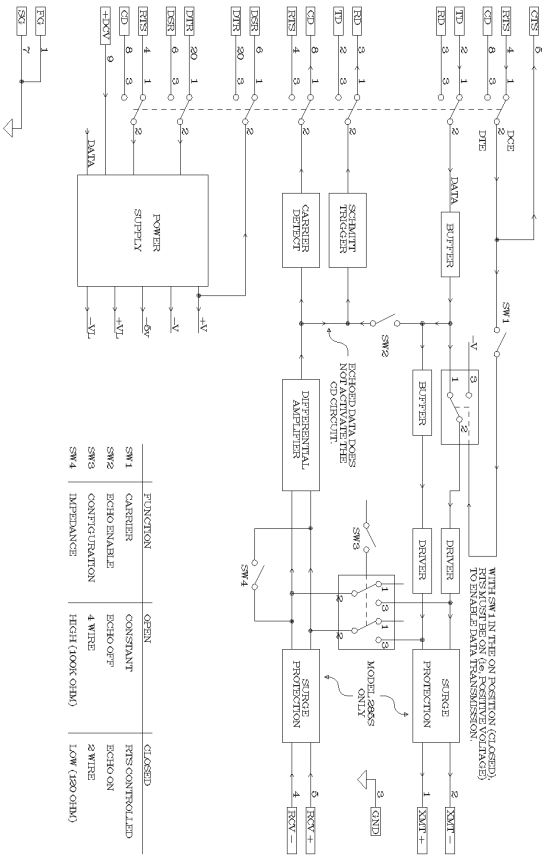

PATRON ELECTRONICS COMPANY			
Title	MODEL 2800 BLOCK DIAGRAM		
Size	Document Number	06A047201-01	REV
A	1		A

Date: 26/01/2008 10:00 Drawn: of