

ViewSonic®

**N3260w/N3760w/N4060w
LCD TV**

- User Guide

- 使用手册

- 使用手册



ViewSonic®

Model No. :
VS10847-1P / VS10848-1P / VS10846-1P

Contents

Compliance Information	1
Important Safety Instructions	2
Copyright Information	3
Product Registration.....	3
Antenna Installation Instructions	4
Cleaning the LCD Display	4

Getting Started

Package Contents	5
Front View of the Product.....	6
Rear View of the product.....	7
Remote Control	8
Notes on the Remote Control	10
Installation	11
Cable connections.....	12

OSD Functions

Image Adjustment	14
Audio Adjustment	15
Screen Adjustment.....	16
Setup Adjustment	17
Options Adjustment.....	19

Appendix

Specifications	21
Troubleshooting	23
Customer Support	24
Limited Warranty	25

Compliance Information

CE Conformity for European Countries

In Europe you must use a cord set which is appropriate for the receptacles in your country. The cord set is HAR-Certified, and a special mark that will appear on the outer sheath, or on the insulation of one of the inner conductors.

AC Plug cord precautions for the United Kingdom

For your safety please read the following text carefully.

If the fitted moulded plug is unsuitable for the socket outlet then the plug should be cut off and disposed of safely.

There is a danger of severe electrical shock if the cut off plug is inserted into an appropriate socket.

CE Conformity for European Countries

CE Conformity



The device complies with the requirements of the EEC directive 89/336/EEC as amended by 92/31/EEC and 93/68/EEC Art.5 with regard to “Electromagnetic compatibility”, and 73/23/EEC as amended by 93/68/EEC Art.13 with regard to “Safety.”

User Information for all Countries

Notice: Use the cables which are included with the unit or specified.



The “HD ready” Logo is a trademark of EICTA.



is a trademark of SRS Labs, Inc.

WOW, technology is incorporated under license from SRS Labs, Inc.



Important Safety Instructions

1. Read these instructions completely before using the equipment.
2. Keep these instructions in a safe place.
3. Heed all warnings.
4. Follow all instructions.
5. Do not use this equipment near water.
6. Clean with a soft, dry cloth. If further cleaning is required, see “Cleaning the Display” in this guide for further instructions.
7. Do not block any ventilation openings. Install the equipment in accordance with the manufacturer’s instructions.
8. Do not install near any heat sources such as radiators, heat registers, stoves, or other devices (including amplifiers) that produce heat.
9. Do not attempt to circumvent the safety provisions of the polarized or grounding-type plug. A polarized plug has two blades with one wider than the other. A grounding type plug has two blades and a third grounding prong. The wide blade and the third prong are provided for your safety. If the plug does not fit into your outlet, consult an electrician for replacement of the outlet.
10. Protect the power cord from being tread upon or pinched, particularly at the plug, and the point where it emerges from the equipment. Be sure that the power outlet is located near the equipment so that it is easily accessible.
11. Only use attachments/accessories specified by the manufacturer.
12. Use only with the cart, stand, tripod, bracket, or table specified by the manufacturer, or sold with the equipment. When a cart is used, use caution when moving the cart/equipment combination to avoid injury from tipping over.
13. Unplug this equipment when it will be unused for long periods of time.
14. Refer all servicing to qualified service personnel. Service is required when the unit has been damaged in any way, such as: if the power-supply cord or plug is damaged, if liquid is spilled onto or objects fall into the unit, if the unit is exposed to rain or moisture, or if the unit does not operate normally or has been dropped.

Copyright Information

Copyright © ViewSonic® Corporation, 2005. All rights reserved.

ViewSonic®, the three birds logo, OnView, ViewMatch, and ViewMeter are registered trademarks of ViewSonic Corporation.

Disclaimer: ViewSonic Corporation shall not be liable for technical or editorial errors or omissions contained herein; nor for incidental or consequential damages resulting from furnishing this material, or the performance or use of this product.

In the interest of continuing product improvement, ViewSonic Corporation reserves the right to change product specifications without notice. Information in this document may change without notice.

No part of this document may be copied, reproduced, or transmitted by any means, for any purpose without prior written permission from ViewSonic Corporation.

Product Registration

To meet your future needs, and to receive any additional product information as it becomes available, please register your product on the Internet at: www.viewsonic.com.

For Your Records	
Product Name:	N3260w / N3760w / N4060w ViewSonic LCD TV Display
Model Number:	VS10847-1P / VS10848-1P / VS10846-1P
Document Number:	N3260w-1P_UG_ENG Rev. 1A 08-11-05 N3760w-1P_UG_ENG Rev. 1A 08-11-05 N4060w-1P_UG_ENG Rev. 1A 08-11-05
Serial Number:	_____
Purchase Date:	_____

Product disposal at end of product life

ViewSonic® is concerned about the preservation of our environment. Please dispose of this product properly at the end of its useful life. Your local waste disposal company may provide information about proper disposal.

The lamp in this product contains mercury. Please dispose of properly in accordance with environmental laws of your location.

Antenna Installation Instructions

1 Outdoor Antenna Grounding

If an outside antenna or cable system is connected to the product be sure the antenna or cable system is grounded to avoid voltage surges and built-up static charges. Article 810 of the National Electrical Code, ANS I /NFPA 70, provides information with regard to proper grounding of the mast and supporting structure, grounding of the lead-in wire to an antenna discharge unit, connection to grounding electrodes, and requirements for the grounding electrode.

2 Lightning

For added protection for this product during a lightning storm, or when it is left unattended and unused for long periods of time, unplug it from the wall outlet and disconnect the antenna or cable system. This will prevent damage to the product due to lightning and power-line surges. Do not disconnect the antenna or the power cord during a heavy storm as lightning may strike while you are holding the cable cord, causing serious injury. Turn off your LCD and wait for the weather to improve.

3 Power Lines

An outside antenna system should not be located in the vicinity of overhead power lines or other electric light or power circuits. When installing an outside antenna system, extreme care should be taken to keep from touching the power lines or circuits as contact with them may be fatal.

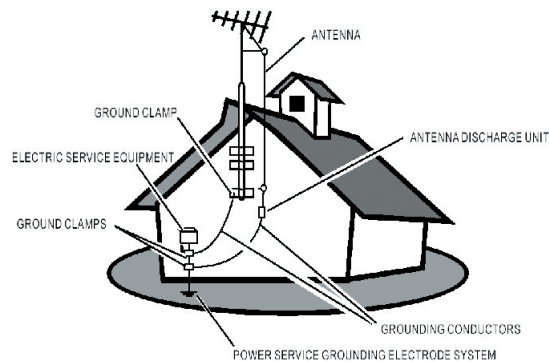

Cleaning the LCD Display

- Make sure the LCD Display is turned off.
- Never spray or pour any liquid directly onto the screen or case.

To clean the screen:

1. Wipe the screen with a clean, soft, lint-free cloth. This removes dust and other particles.
2. If still not clean, apply a small amount of non-ammonia, non-alcohol based glass cleaner onto a clean, soft, lint-free cloth, and wipe the screen.

To clean the case:

1. Use a soft, dry cloth.
2. If still not clean, apply a small amount of non-ammonia, non-alcohol based, mild non-abrasive detergent onto a clean, soft, lint-free cloth, then wipe the surface.

Disclaimer

ViewSonic does not recommend the use of any ammonia or alcohol-based cleaners on the LCD screen or case. Some chemical cleaners have been reported to damage the screen and/or LCD case. ViewSonic will not be liable for damage resulting from use of any ammonia or alcohol-based cleaners.

Getting Started

Congratulations on your purchase of a ViewSonic LCD TV display. Important! Save the original box and all packaging material for future shipping needs.

Package Contents

Please confirm that the following accessories are present when you unpack the box:

- LCD TV
- Remote Control (batteries included)
- Power Cable
- AV Cable
- Color Quick Start Guide
- User Guide
- Non-Grounded AC Power Adapter for United Kingdom
- Non-Grounded AC Power Adapter for Continental Europe

Front View of the Product

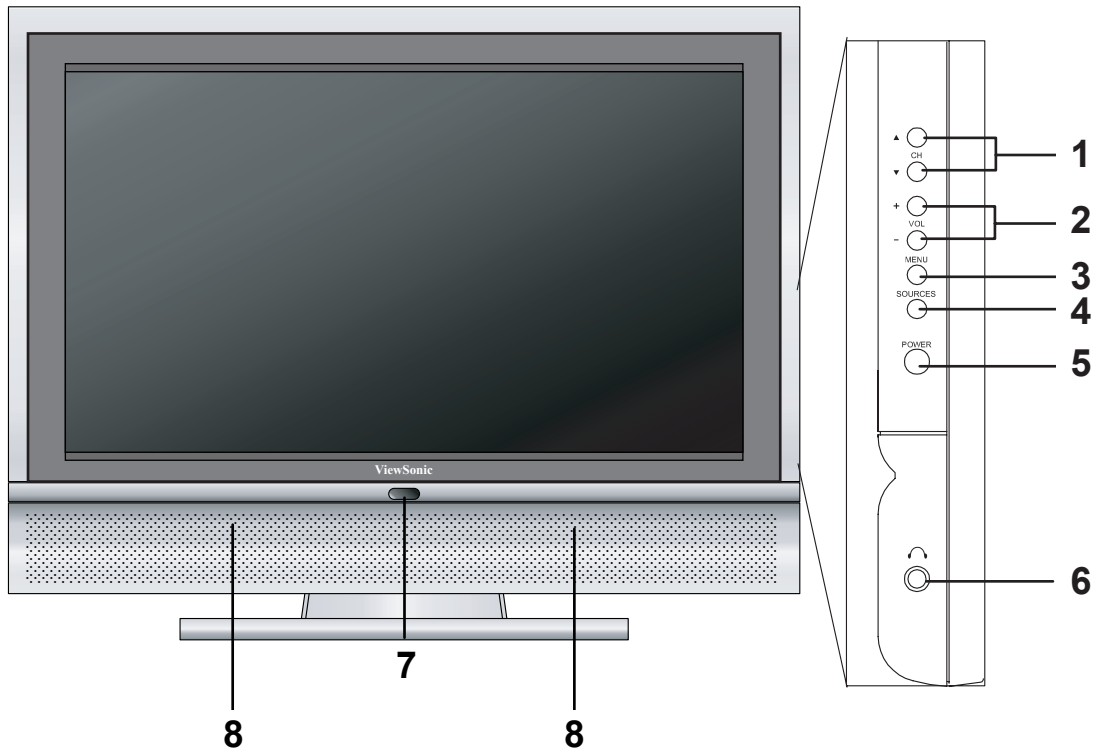

- 1 CH ▲ / ▼**
Changes the channel.
- 2 VOL +/-**
Used for changing the volume.
- 3 MENU**
Display menu screen.
- 4 SOURCE**
Switch between display input sources.
- 5 POWER**
Turns the TV on and off. A green light indicates that TV is on and red that it is off.
- 6 EARPHONE** 
Used for connecting headphones to the TV.
- 7 Power indicator LED**
GREEN shall apply during all operational states (i.e. with image present), Orange shall apply DPMS State for RGB/DVI (HDMI). RED shall apply when the product in stand-by mode.(DPMS state only in PC mode)
- 8 SPEAKERS**
Audio output.

Power Lock

Press MENU and VOL + buttons at the same time can lock the function of Power button.

OSD Lock

Press VOL - and VOL + buttons at the same time can lock the function of MENU button.

Rear View of the Product

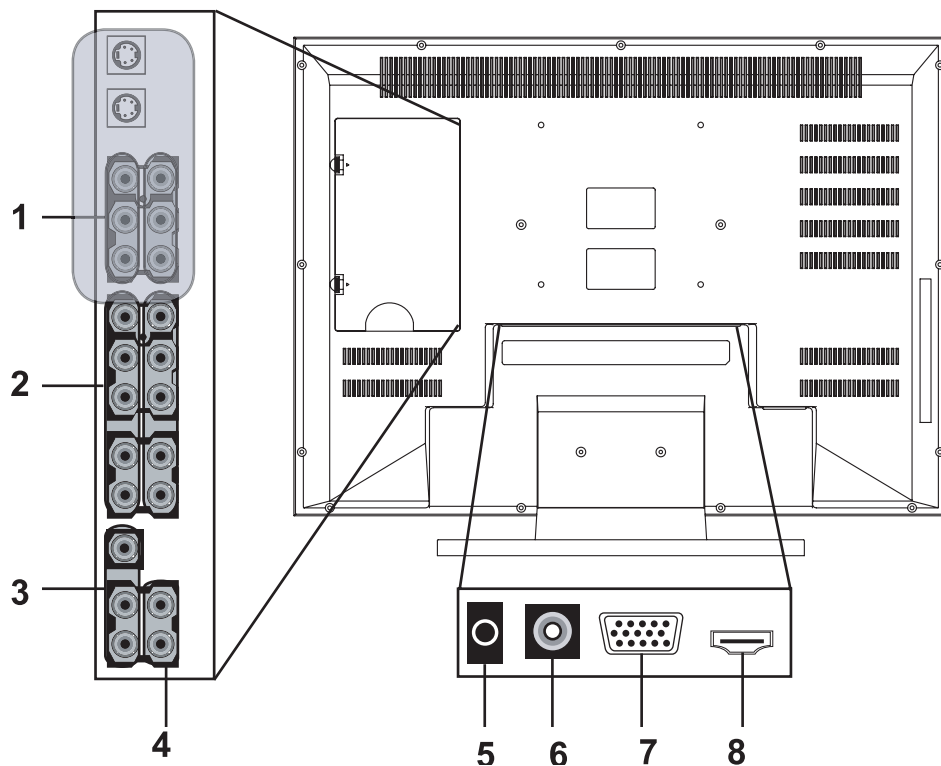

- 1 S / AV - IN**
Connects to the audio and S-Video or AV output jack of your A/V device.
- 2 HDTV 1 / HDTV 2**
Connects to the audio and component video output jacks of your A/V device.
- 3 A/V OUT**
Decodes the signal input via AV-IN and outputs from VIDEO OUT to display another image on second TV.
- 4 HDMI ANALOG AUDIO - IN**
Connects to the HDMI audio output of your PC or A/V device.
- 5 PC Audio - IN**
Connects to the audio output (earphone jack) of your PC or portable computer.
- 6 ANT**
Connects to your UHF antenna or coaxial cable a from local TV.
- 7 PC - IN**
Connects to your VGA output of your PC or portable computer.
- 8 HDMI - IN**
Connects to your HDMI output of A/V device.

Remote Control

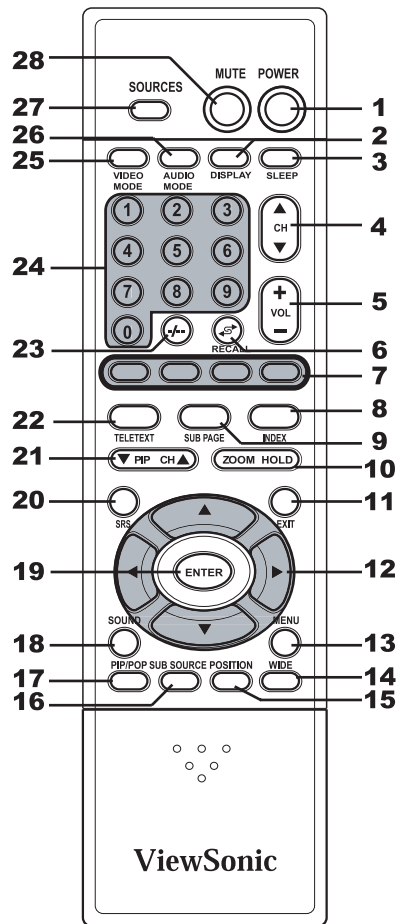

- 1 POWER**
Turns power on or off.
- 2 DISPLAY**
Press repeatedly to display current time, channel number, or video input signal.
- 3 SLEEP**
Press repeatedly to set the off timer to 15 through 120 minutes. The TV enters stand-by mode after the specified time interval.
- 4 CH▲▼**
Increases ▲ or decreases ▼ the channel number.
- 5 VOL – / +**
Increases (+) or decreases (–) the volume.
- 6 RECALL**
Switches to the previously viewed channel.

7 TELETEXT HOT KEYS

Select groups of pages in teletext mode.(Europe Only)

8 INDEX

Displays a list and information about the teletext pages.

9 SUB PAGE

Displays the teletext as an overlay over the programme you are currently watching.

10 ZOOM / HOLD

Zoom enlarges the teletext page; Hold freezes the current teletext page on the screen.

11 EXIT

Press the button to exit the present menu.

12 ARROW KEYS

Press the up, down, left, right arrow keys to scroll through the OSD menu options.

13 MENU

Displays the OSD menu. Press repeatedly to view the different menu pages or exit the OSD menu.

14 WIDE

Switches the display mode between various wide modes. (Auto, 4:3, 16:9 Zoom, 14:9)

15 POSITION

Changes the display position of the Sub Picture in PIP mode.

16 SUB SOURCE

Press to toggle the Sub picture between PIP and POP. In HDMI status, resolution modes 1280*1024, 1280*768, 1280*720, and 1360*768 will not be supported and will show "NO SUPPORT" on screen.

17 PIP / POP

Toggles between PIP and POP modes.

18 SOUND

Switches between monaural, stereo enables audio modes.

19 ENTER

Press this button to execute the order you choose.

20 SRS

Turns SRS Sound Enhancement ON or OFF. Audio mode will be closed when SRS Sound Enhancement ON .Audio mode will be opened when SRS Sound Enhancement OFF.

- 21 PIP CH ▲ ▼**
Switches the channel of sub picture.
- 22 TELETEXT**
Starts teletext mode.
- 23 - / - -**
Press ▲ button to choose a channel number higher than 100.
- 24 NUMBER KEYS**
Press the number keys to enter channel numbers.
- 25 VIDEO MODE**
Switches between four video modes to change the picture quality: Custom, Vivid, Mild, Standard.
- 26 AUDIO MODE**
Switches between four audio modes to change the sound quality: Custom, LIVE, POP, ROCK.
- 27 SOURCES**
Selects the TV,AV,PC/HDMI inputs as the video source signal.
(in “MP SOURCE”mode)
- 28 MUTE**
Disables the audio output.

Notes on the Remote Control

- The remote control’s effective range is 5 meters from the LCD screen at an angle of up to $\pm 30^\circ$.
- Direct light may affect the remote controls effective range.
- Avoid subjecting the remote control to shocks or vibrations.
- Avoid placing the remote control in humid and hot environments such as direct sunlight.
- Remove the batteries when not using the remote control for long periods.
- ViewSonic also offers a universal remote control option; contact viewsonic for more details (www.viewsonic.com).

Remote Control Battery Installation

Follow the steps below to insert the batteries.

- 1 Open the remote control's rear battery compartment cover.
- 2 Insert two AAA batteries. Ensure that the positive and negative ends match as indicated on the bottom of the battery compartment.
- 3 Replace the battery compartment cover.

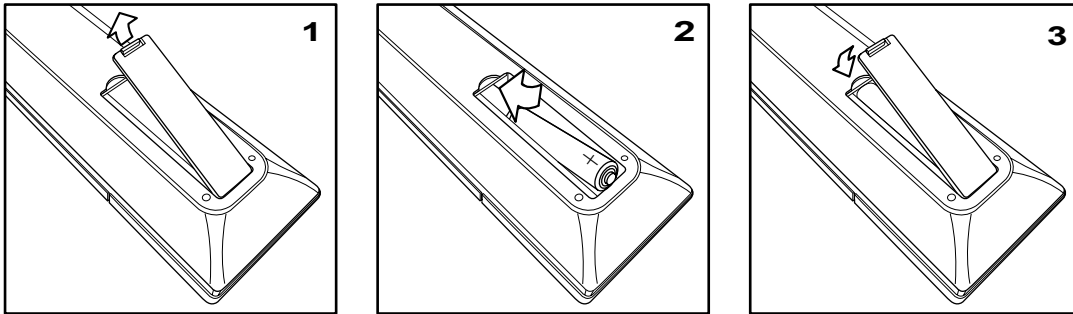

CAUTION

- Only use the specified AAA batteries.
- Do not mix new and old batteries. This may result in cracking or leakage, which may pose a fire risk or lead to personal injury.
- Insert batteries according to the (+) and (-) markings. Inserting the batteries incorrectly may result in cracking or leakage, which may pose a fire risk or lead to personal injury.
- Dispose of batteries in accordance with local laws and regulations.
- Keep batteries away from children and pets.
- If the remote control will not be used for an extended period of time, remove the batteries.

Cable Connections

Attach video and audio cables according to the connections on your external devices such as DVDs, VCR's, stereo systems.

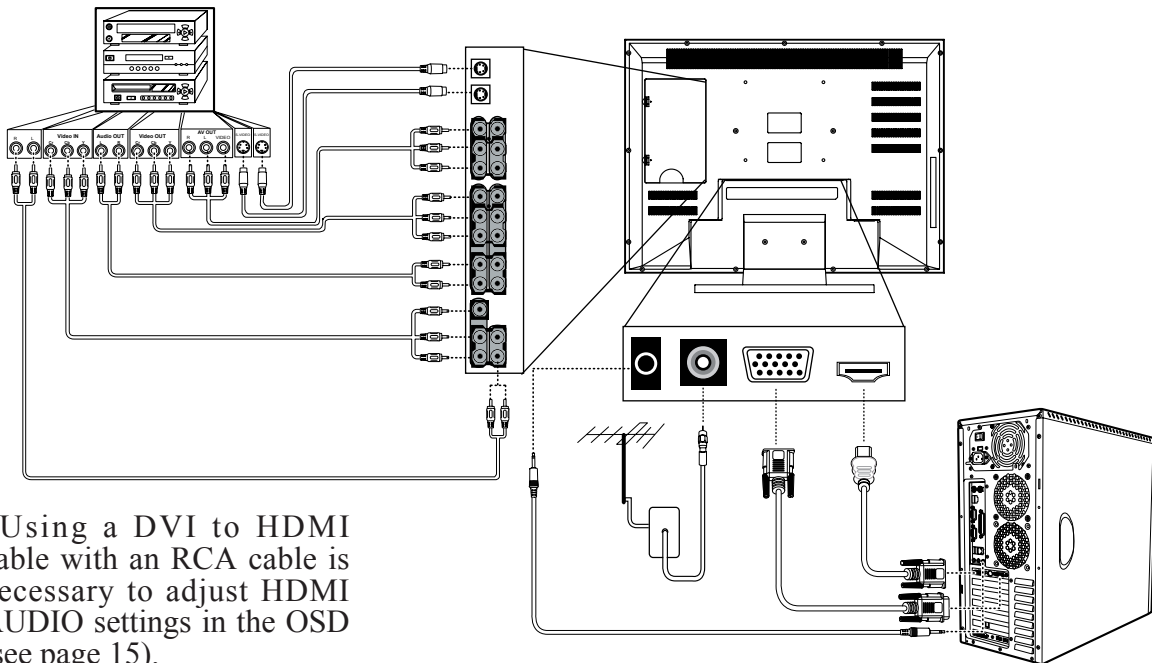

*Using a DVI to HDMI cable with an RCA cable is necessary to adjust HDMI AUDIO settings in the OSD (see page 15).

Power Cable Connection

- 1 Connect the power cable to a wall socket.
- 2 Connect the other end to the socket on the back of the LCD.

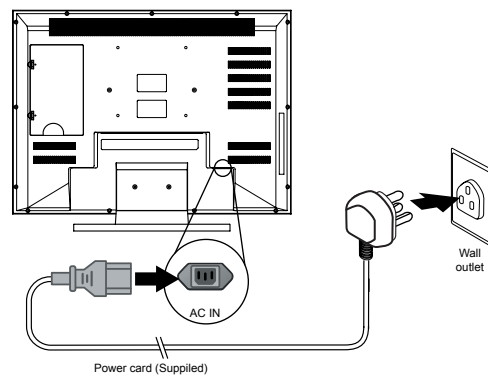

Turning the TV (Power) On

- 1 Press the power button. The power light will turn from red to green and the screen will appear after 5 seconds.
- 2 Press the power button again to turn it off.

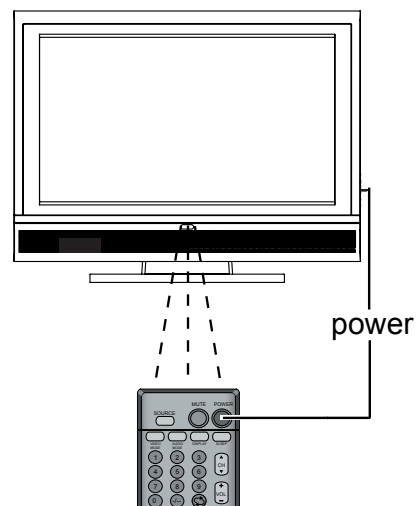

OSD Functions

All the functions for the LCD TV are controlled either by the remote control or the control buttons on the right hand side of the TV. See “Front View of the Product” on page6.

Press the **MENU** button on the remote control or the control button on the right hand side of TV to display the OSD main menu.



Press the **MENU** button to select the OSD menu you want.

Press the **CH** ▲/▼ or the ▲/▼ buttons to select an OSD menu item.

Press the **VOL** +/- or the ◀/▶ buttons to change the values of the selected menu item.

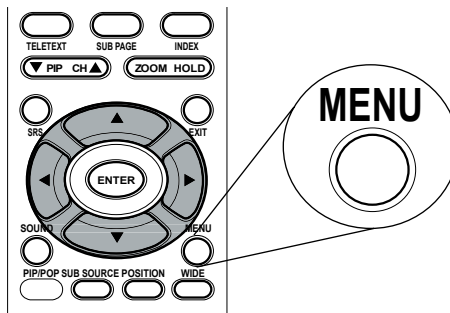

Press the **MENU** button or exit button to exit the OSD .

Image Adjustment



Function Name	Explanation
Picture Mode	Adjusts the levels of light on your screen.
Contrast	Adjusts the difference between the dark and light levels on your display. It should be used in conjunction with the Brightness option.
Brightness	Adjusts the levels of light on your screen. It should be used in conjunction with the Contrast option.
Colour	Adjusts the colour levels to fit your own favorite.
Tint	Changes the colour balance. Adjust this setting so that the colours (for example, flesh tones) on the screen are neither too green or too magenta.
Sharpness	Adjusts the sharpness levels on your screen.
NR	Enables you to set Noise Reduction. Noise Reduction reduces the noise the comes from video.

Audio Adjustment



Function Name	Explanation
Volume	Adjusts the overall volume of the speakers.
Balance	Balance the volume of the left and right speakers.
Equalizer	Press ◀ / ▶ button to switch sonics : POP, LIVE, ROCK and CUSTOM.
Treble	Adjusts the high frequency content in the audio output.
Bass	Adjusts the low frequency content in the audio output.
Sound Mode	Selects the audio mode for your LCD TV. In many locations, you can listen to a secondary audio source in addition to the primary source. Select from STEREO , MONO or Dual 1 , Dual 2 .
SRS	Switches SRS function on or off.
HDMI Audio	Adjusts the setting of HDMI mode. The default setting is digital. When using a DVI to HDMI cable, the setting changes to analog.

Screen Adjustment

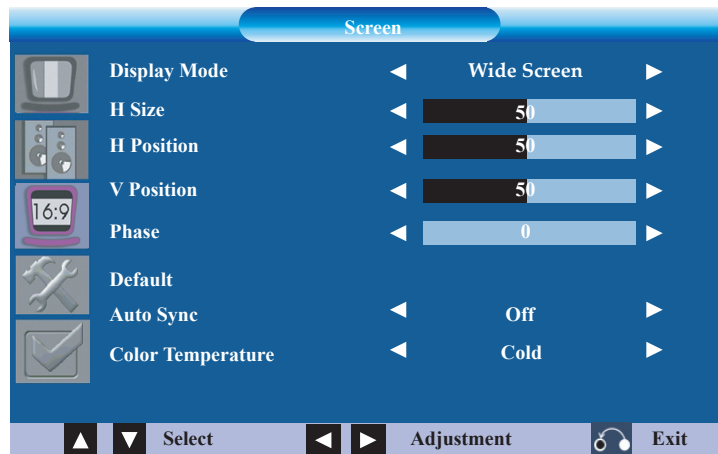

Function Name	Explanation
Display Mode	Adjusts the size of the display mode.
H Size (PC Only)	Adjusts the size of horizontal.
H Position (PC Only)	Adjusts the horizontal position of the display.
V Position (PC Only)	Adjusts the vertical position of the display.
Phase (PC Only)	Adjusts the phase for the display.
Default (PC Only)	Resets all settings to the default settings.
Auto Sync (PC Only)	Adjusts the available channels automatically.
Color Temperature (PC Only)	Enables you to set the colour temperature: Cold : sets the colour tone to cooler tones. Standard : sets the colour tone to standard colours. Warm : sets the colour tones to warmer tones (more red).

Setup Adjustment



Function Name	Explanation
Tuning	Enables you to modify, add, or delete channels from the available channels and set the channel hotkey or the Channel data for your own habit.
Program Table	Name the channel you choose. (Only can type in English.)
Auto Search	Automatically scans for available channels.

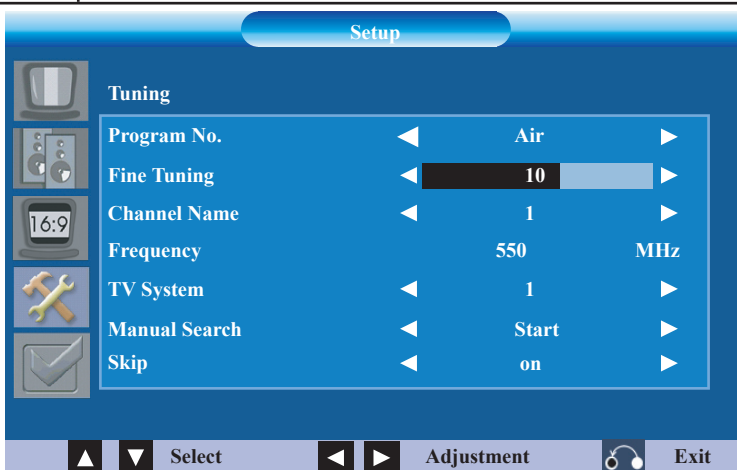

Function Name	Explanation
Program No.	Displays the channel number you set.
Fine Tuning	Enables you to change the frequency for the channel.
Channel Name	Name the channel you favorite.
Frequency	Display the channel frequency as you search channels.
TV System	Chooses the source of TV signal.
Manual Search	Scan the channels you choose.
Skip	Selects YES to delete the channel from the channel list.

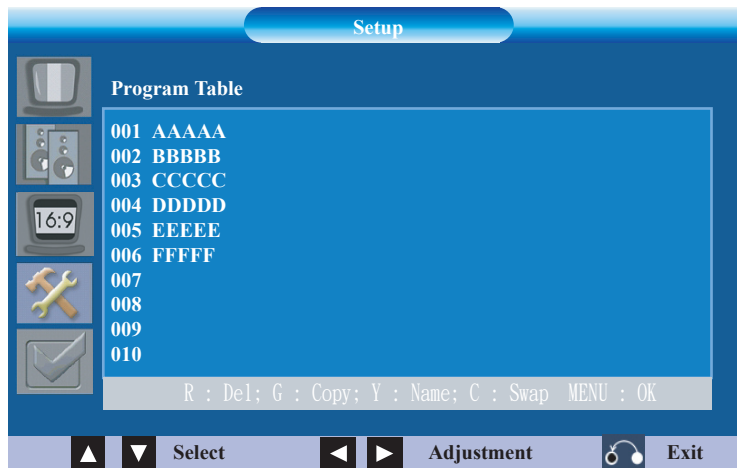

In this page, you can name the channel you choose.

Press ▲ / ▼ to select the channel number and press Y button to name the channel.
You need enter at least 1 letter.

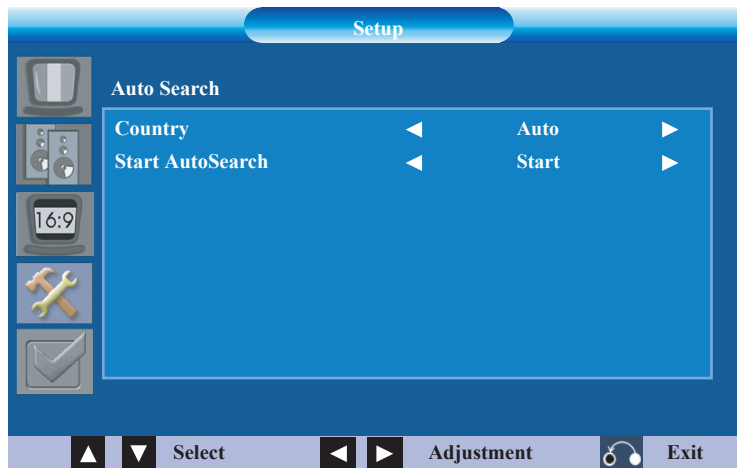

In this page, you can choose the available channel in

Function Name	Explanation
Country	Press ◀ / ▶ to choose the available country where you are. It include: China, England, Turkey, Germany, Switzerland, France and AUTO.
Start Autosearch	Press ◀ / ▶ to start search available channel AutoSearch automatically

Options Adjustment



Function Name	Explanation
Menu Language	Changes the OSD display language. The following options are available: English, Traditional Chinese, Simplify Chinese.
Sleep Timer	Enables you to set a time that will elapse before the TV turns off. Options are from OFF →15 →.....→ 120 minutes.
Menu Background	This TV allows you choose following option to switch menu background : Opaque/ Mode 1/ Mode 2/ Mode 3/ Mode 4.
Source Information	Shows this TV's input source information.
Reset	Reset the settings of all menus.
PC Display	Shows the picture quality. The default is 1280*768. Adjusts the resolution setting if the VGA card in the PC is 1360*768.

Source Information

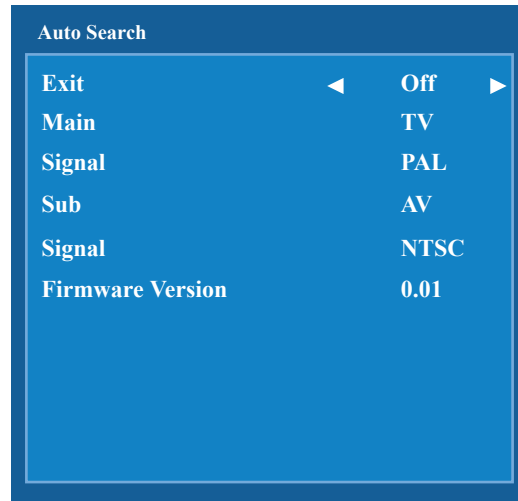

Function Name	Explanation
Exit	Press ◀ / ▶ button to exit.
Main	Shows main picture's input source.
Signal	Shows main signal's category.
Sub	Shows sub picture's input source.
Signal	Shows sub signal's category.
Firmware Version	Shows the firmware's version.

Appendix

Specifications

Panel	Type	32" (full 31.5" viewable diagonal area) 37" (full 37.02" viewable diagonal area) 40" (full 39.9" viewable diagonal area) Active Matrix Wide-XGA, 1360 x 768
	Color	Anti-reflective coating + Anti-glare coating
Viewing angles		32" 170° (H) / 170° (V) 37" 176° (H) / 176° (V) 40" 170° (H) / 170° (V)
Input signal	Video	VGA input * 1 TV system antenna Composite Video input * 2 S-Video * 2 Component Video * 2 (YCbCr, YPbPr) HDMI * 1
	Audio	Audio input (3.5 for VGA * 1), (RCA * 3 are for DVI Audio IN) Audio output * 1
Compatibility	PC	Up to 1360 x 768 Non-interlaced
	Macintosh1	Up to 832 x 624 Non-interlaced
Resolution	Supported	1280 x 1024 @ 60 Hz* 1024 x 768 @ 60/70/75 Hz 1280 x 768 @ 60 Hz* 1280 x 720 @ 60 Hz(it is the PC reference mode)* 1360 x 768 @ 60 Hz (it is the PC reference mode) 832 x 624 @ 75 Hz (Mac) 800 x 600 @ 60/75 Hz 640 x 480 @ 60/75 Hz(it is the PC reference mode) 720 x 400 @ 70 Hz
Speaker Output		10 W + 10 W
Power	Voltage	100-240 VAC, 50/60 Hz (auto switch), 32" : 190W 37" : 220W 40" : 260W
Operating conditions	Temperature	0°C to 40°C (32°F to 104°F)
	Humidity	10% to 85% (no condensation)
	Altitude	To 3000 meters

Storage conditions	Temperature	-20°C to 60°C (-4°F to 140°F)
	Humidity	10% to 90% (no condensation)
	Altitude	To 12,000 meters
Dimensions	Physical	32" : 820 mm (W) x 650 mm (H) x 230 mm (D) 32.3" (W) x 25.6" (H) x 9.1" (D)
		37" : 960 mm (W) x 730 mm (H) x 280 mm (D) 37.8" (W) x 28.7" (H) x 11" (D)
		40" : 1015 mm (W) x 755 mm (H) x 280 mm (D) 40.0" (W) x 29.7" (H) x 11" (D)
	Package	32" : 960 mm (W) x 780 mm (H) x 320mm (D) 37.8" (W) x 30.7" (H) x 12.6" (D)
		37" : 1130mm (W) x 870 mm (H) x 370 mm (D) 44.5" (W) x 34.3" (H) x 14.6" (D)
		40" : 1145 mm (W) x 910 mm (H) x 370 mm (D) 45.1" (W) x 35.8" (H) x 14.6" (D)
Weight	Net	32" : 22 kg (48.5 lb.)
		37" : 31 kg (68.3 lb.)
		40" : 33 kg (72.7 lb.)
	Gross	32" : 26.5 kg (58.4 lb.)
		37" : 38.5 kg (84.9 lb.)
		40" : 40.0 kg (88.1 lb.)
Regulations	CB, PSB, C-Tick	
Power saving modes	Stand by	<1.5 W (Red LED)

Preset Timing Mode (Pre-adjusted to VESA 1360 x 768 at 60 Hz)

Warning : Do not set the graphics card in you computer to exceed these refresh rates. Doing so may result in permanent damage to the LCD.

Note : Product specifications are subject to change without notice.

Troubleshooting

No power

- Make sure the LCD is properly connected. (see also pages 12)
- Make sure the AC power cord is properly connected. (see also page 12)
- Make sure the AC power is ON, DC power button is ON (Green LED).
- Plug another electrical device (like a radio) to the power outlet to verify that the outlet is supplying the proper voltage.

Poor or no picture

- The TV station may be experiencing problems. Try another channel.
- The Cable TV signal may be scrambled or encoded. Please contact your local cable operator.
- Make sure that connection to other components are correct. (see also pages 12)
- Make sure that setup has been done correctly after connections. (see also pages 14-19)
- Make sure the correct input is selected and the input signal is compatible.

Strange color, light color, or color misalignment

- Ensure that the video cable is securely connected.
- The picture may appear dim in a brightly lit room.
- Adjust brightness and contrast.
- Check the input signal setting.

No sound

- Check your audio connections
- The **MUTE** button may have been pressed, try pressing this button again.
- Check your audio settings, your TV audio may be set to minimum.
- Press the **Volume + (Up)** button on the remote control.

Remote control unit does not operate

- Make sure batteries are inserted correctly. (see also page 11)
- Batteries could be weak or dead. Replace batteries.
- Is a fluorescent light illuminated near the remote control sensor?
- The path of the remote control beam may be blocked. Make sure the path is clear and that the remote control is aimed at the remote control sensor on the TV.
- Press only one button at a time and it is the correct one for the operation you want to perform..

Unit cannot be operated

- External influences such as lightning or static electricity may cause improper operation. In this case, operate the unit after first turning on the power of the LCD and the AVC System, or unplug the AC cord for 1 to 2 minutes, then replug again.

Power is cut off suddenly

- Is the sleep timer set? (see also page 19)
- The internal temperature of the unit has increased. Remove any objects blocking the vent or clean as necessary.

No CATV reception (or no reception above CH13)

- Is the AIR/CABLE option set correctly? Please set the AIR/CABLE option to CABLE.
- CATV is connected improperly or not connected; please check all the CATV connections.
- The cable TV service is interrupted; please contact your cable operator.

Picture is cut off/with sidebar screen

- Is the image positioned correctly?
- Are screen mode adjustments such as picture size set correctly?

Customer Support

For technical support or product service, see the table below or contact your reseller.

Note: You will need the product serial number.

Country/ Region	Web Site	T=Telephone F=Fax
United States	www.viewsonic.com/support/	T= (800) 688 6688 F= (909) 468 1202
Canada	www.viewsonic.com/support/	T= (866) 463 4775
United Kingdom	www.viewsoniceurope.com/uk	T= 0207 949 0307
Europe/Middle East/ Baltic countries/ North Africa	www.viewsoniceurope.com	Contact your reseller
Australia and New Zealand	www.viewsonic.com.au/support/	AUS= 1800 880 818 NZ= 0800 008 822
Singapore/ Malaysia/Thailand	www.viewsonic.com.sg/support/	T= (65) 6273 4018 F= (65) 6273 1566
South Africa/Other countries	www.viewsonic.com	T= +886 (2) 2246 3456 F= +886 (2) 2249 1751
Hong Kong	www.hk.viewsonic.com/support/	T= +852 3102 2900
Macau	www.hk.viewsonic.com/support/	T= +853 700 303
Korean	www.viewsonic.com	T= 080 333 2131

Limited Warranty

VIEWSONIC® LCD TV

What the warranty covers:

ViewSonic® warrants its products to be free from defects in material and workmanship, under normal use, during the warranty period. If a product proves to be defective in material or workmanship during the warranty period, ViewSonic® will at its sole option repair or replace the product with a like product. Replacement product or parts may include remanufactured or refurbished parts or components.

How long the warranty is effective:

ViewSonic® LCD TV's are warranted for one (1) year for all parts excluding the light source and one (1) year for labor from the date of the first customer purchase.

Who the warranty protects:

This warranty is valid only for the first consumer purchaser.

What the warranty does not cover:

1. Any product on which the serial number has been defaced, modified or removed.
2. Damage, deterioration or malfunction resulting from:
 - a. Accident, misuse, neglect, fire, water, lightning, or other acts of nature, unauthorized product modification, or failure to follow instructions supplied with the product.
 - b. Repair or attempted repair by anyone not authorized by ViewSonic®.
 - c. Any damage of the product due to shipment.
 - d. Removal or installation of the product.
 - e. Causes external to the product, such as electric power fluctuations or failure.
 - f. Use of supplies or parts not meeting ViewSonic's specifications.
 - g. Normal wear and tear.
 - h. Any other cause which does not relate to a product defect.
3. Any product exhibiting a condition commonly known as "image burn-in" which results when a static image is displayed on the product for an extended period of time.
4. Removal, installation, and set-up service charges.

How to get service:

1. For information about receiving service under warranty, contact ViewSonic® Customer Support at 800-888-8583. You will need to provide your product's serial number.
2. To obtain warranted service, you will be required to provide (a) the original dated sales slip, (b) your name, (c) your address, (d) a description of the problem, and (e) the serial number of the product.
3. Take or ship the product freight prepaid in the original container to an authorized ViewSonic® service center or ViewSonic®.
4. For additional information or the name of the nearest ViewSonic® service center, contact ViewSonic®.

Limitation of implied warranties:

There are no warranties, express or implied, which extend beyond the description contained herein including the implied warranty of merchantability and fitness for a particular purpose.

Exclusion of damages:

ViewSonic's liability is limited to the cost of repair or replacement of the product. ViewSonic® shall not be liable for:

1. Damage to other property caused by any defects in the product, damages based upon inconvenience, loss of use of the product, loss of time, loss of profits, loss of business opportunity, loss of goodwill, interference with business relationships, or other commercial loss, even if advised of the possibility of such damages.
2. Any other damages, whether incidental, consequential or otherwise.
3. Any claim against the customer by any other party.

Effect of state law:

This warranty gives you specific legal rights, and you may also have other rights which vary from state to state. Some states do not allow limitations on implied warranties and/or do not allow the exclusion of incidental or consequential damages, so the above limitations and exclusions may not apply to you.

Sales outside the U.S.A. and Canada:

For warranty information and service on ViewSonic® products sold outside of the U.S.A. and Canada, contact ViewSonic® or your local ViewSonic® dealer.



ViewSonic®