

# KWC

ARMATUREN +  
ROBINETTERIE  
RUBINETTERIA  
GRIFERIA  
FAUCETS

## 802259

(A017164)  
09/04

Montage- und Service-Anleitung

Instruction de montage et d'entretien

Istruzione di montaggio e di assistenza

Instrucciones de montaje y servicio

Installation and service instruction

KWC Wannen-Füllkombination

(4-Loch mit Umsteller)

KWC Robinetterie pour grandes baignoires

(4 trous avec inverseur)

Rubinetteria per grandi vasche

(4 fori con deviatore)

Griffería para grandes bañeras

(4 agujeros con inversor)

KWC Roman Tub Sets

(4 hole with diverter)

**Fertigmontage-Set**  
**Set de montage finale**  
**Set di montaggio finale**  
**Set de montaje final**  
**Trim-Set**

**KWC DESIGNO**

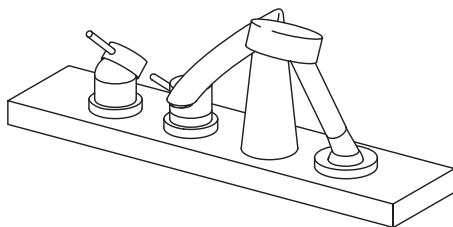

**20.807.683**

**KWC FAMOSO**

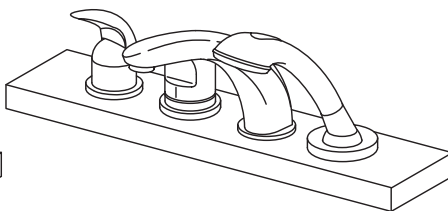

**20.817.684**



**Technische Änderungen vorbehalten.**  
**Sous réserve de modifications technique.**  
**Salvo cambiamenti tecnici.**  
**Sujeto a alterações técnicas.**  
**Subject to technical alternation.**

**Schweiz, Switzerland:**  
KWC AG  
Hauptstrasse 57  
CH-5726 Unterkulm

Tel. :+41 62 768 67 77  
Fax : +41 62 768 61 69

**USA:**  
KWC Faucets Inc.  
1770 Corporate Drive #580  
Norcross, Georgia 30093

Phone: +01 678 334 2121  
Fax: +01 678 334 2128

**Canada:**  
Nortesco Inc.  
151 Carlingview Drive, Unit 12  
Rexdale, ONTARIO, M9W 5S4

Phone: +01 416 675 34 34  
Fax: +01 416 675 01 67



Recyclingpapier auf 100% Altpapierbasis.  
Papier de recyclage sur 100% bases de vieux papier.  
Riciclaggio della carta sulla base della carta straccia di 100%.  
Reciclaje del documento sobre base del papel usado del 100%.  
Recycling paper on 100% waste paper basis.

**Betriebsdaten****Caractéristiques de fonctionnement****Caratteristiche di funzionamento****Datos de servicio****Operating data****Betriebsdaten:**

Idealer Betriebsdruck	: 3 bar
Max. Betriebsdruck	: 5 bar
Ideale Wassertemperatur	: 60 °C
Max. Wassertemperatur	: 80 °C

**Caractéristiques de fonctionnement**

Pression de service idéale	: 3 bar
Pression de service max.	: 5 bar
Température idéale de l'eau	: 60°C
Température max. de l'eau	: 80°C

**Achtung:**

Vor Montage die Leitungen gründlich durchspülen!

**Attention:**

Rincer à fond la tuyauterie avant le montage!

Weitere Informationen finden Sie in unseren detaillierten Verkaufsunterlagen.

Pour informations supplémentaires voir nos documentations de vente détaillées.

**Caratteristiche di funzionamento**

Pressione di servizio ideale	: 3bar
Pressione di servizio mass.	: 5bar
Si raccomanda pressioni uguali.	
Temperatura acqua calda ideale	: 60°C
Temperatura acqua calda mass.	: 80 °C

**Datos de servicio**

Presión ideal de servicio	: 3 bar
Presión máxima de servicio	: 5 bar
Se recomienda la igualdad de las presiones.	
Temperatura ideal del agua	: 60 °C
Temperatura máxima del agua	: 80 °C

**Attenzione:**

Risciacquare bene le tubazioni prima del montaggio!

**Atención:**

Enjuagar escrupulosamente las tuberías antes del montaje!

Ulteriori informazioni le troverete nelle nostre dettagliate documentazioni.

Información más detallada en nuestra documentación de ventas.

**Operating data**

Ideal operating pressure	: 3 bar (45 PSI)
Max. operating pressure	: 5 bar (70 PSI)
Equal pressures are recommended.	
Ideal water temperature	: 60 °C (140°F)
Max. water temperature	: 80 °C (180°F)

**Attention:**

Before installation flush pipes thoroughly!

For further information refer to our detailed sales literature.



**D Bei Frostgefahr Hausanlage entleeren.**

**F En cas de risque de gel, vidanger l'installation d'immeuble.**

**I In caso di pericolo di gelo, svuotare l'impianto.**

**Sp En caso de peligro de hielo, purgar la instalacion de agua, obien vaciar las tuberías**

**E Drain system completely if danger of frost..**



- D** Schäden, die infolge unsachgemässer Behandlung, natürlicher Abnutzung oder zu grosser Inanspruchnahme entstanden sind, sind von unseren Garantieleistungen ausgeschlossen!
- F** Ces dommages survenus en raison d'un traitement inadéquat, des signes d'usure traitement inadéquat, naturels ou du grand utilisation, sont exclus de notre garantie.
- I** Danni ai rubinetti, conseguenti da un trattamento non appropriato, sono esclusi dalla nostra garanzia!
- Sp** Daños, debidos a un tratamiento inadecuado, son excluidos de la nuestra garantía.
- E** Damages of the faucets as a result of incorrect handling are excluded from the manufacturers warranty!

**D** Vor Einbau der Armatur Rohrleitungen spülen!  
**F** Avant la pose du mitigeur purger l'installation!  
**I** Prima di installare il miscelatore spurgare bene le condutture!  
**Sp**Antes de colocar el monocomando limpiar la instalatiòn.  
**E** Flush pipes well before installing mixer!

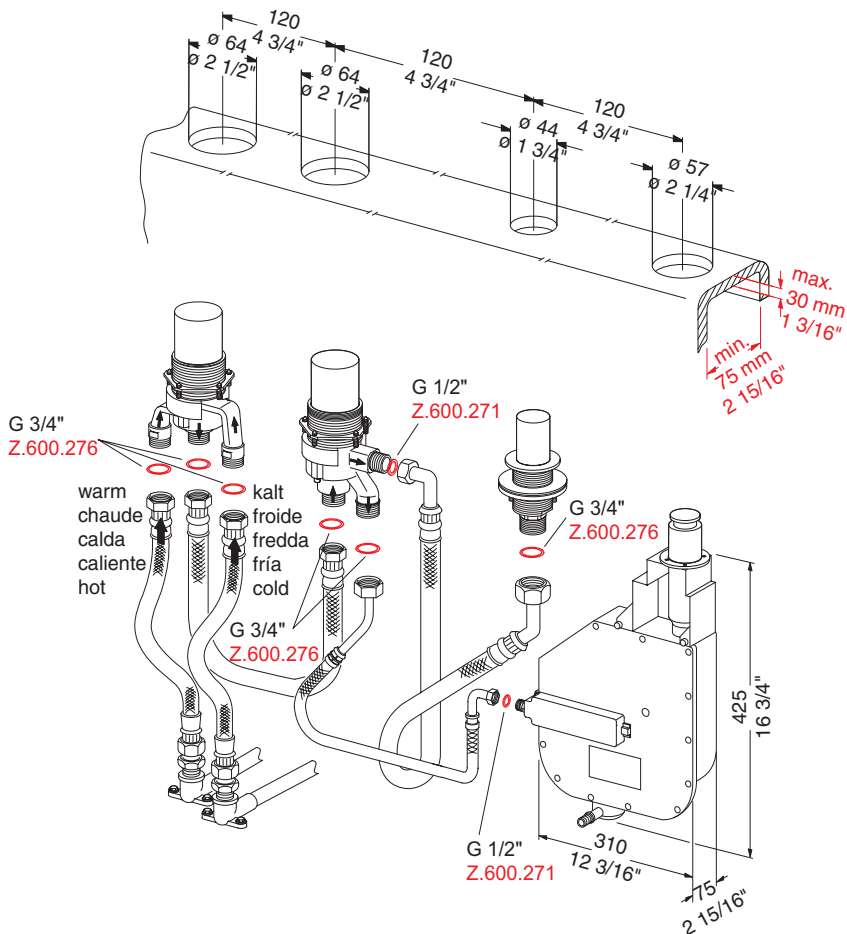

Montage  
Montage  
Montaggio  
Montaje  
Installation

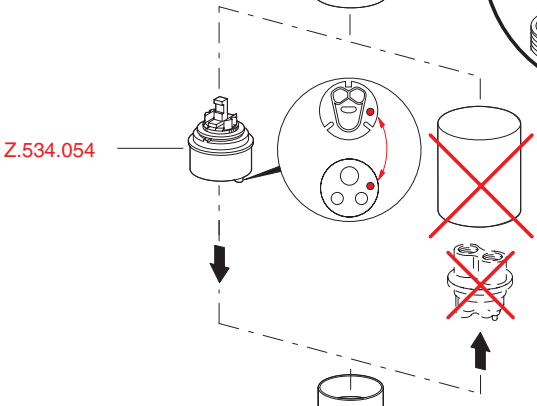
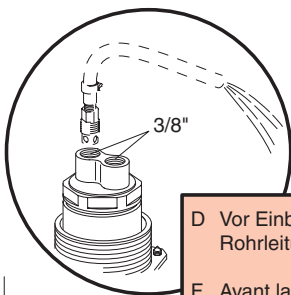
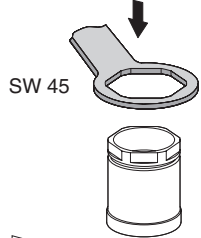
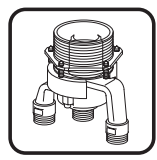
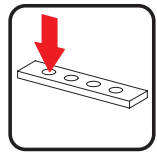
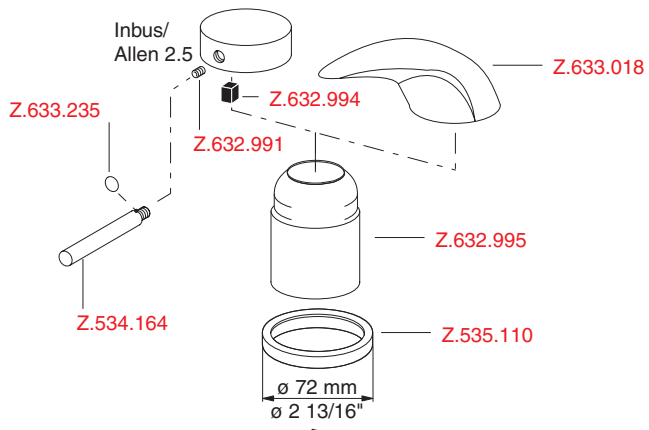

D Vor Einbau der Armatur Rohrleitungen spülen!

F Avant la pose du mitigeur purger l'installation!

I Prima di installare il miscelatore spurgare bene le condutture!

Sp Antes de colocar el monocomando limpiar la instalación!

E Flush pipes well before installing mixer!

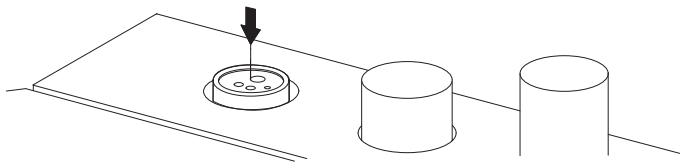

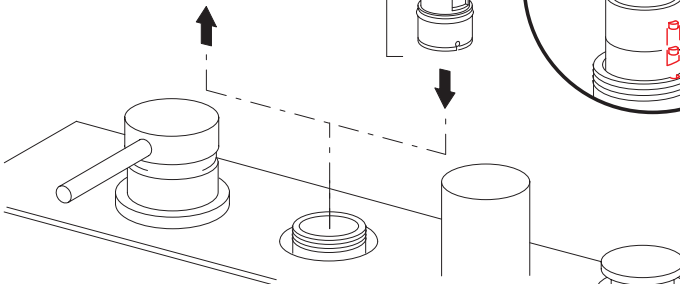
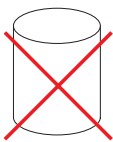
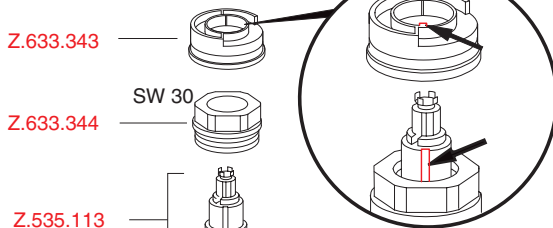
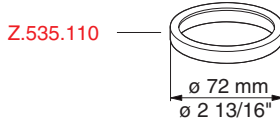
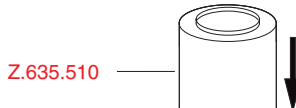
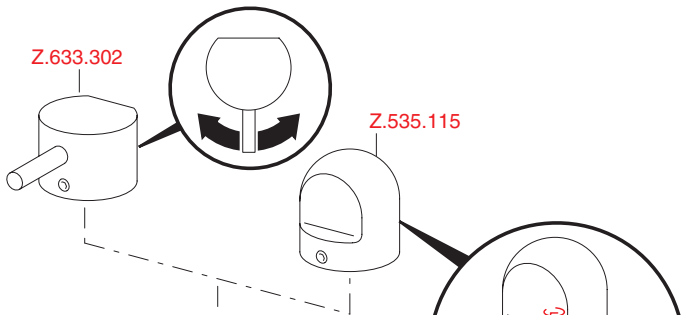
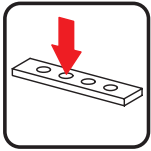

Montage  
Montage  
Montaggio  
Montaje  
Installation

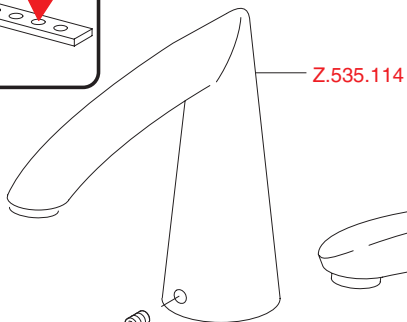
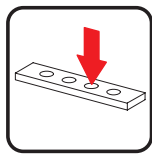

Z.535.114

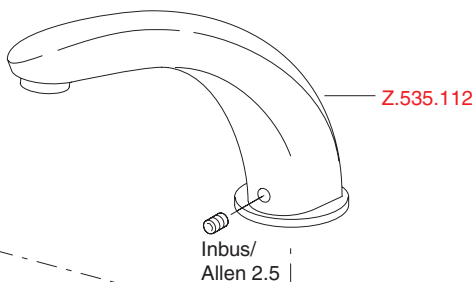

Z.535.112



Inbus/  
Allen 2.5

Inbus/  
Allen 2.5

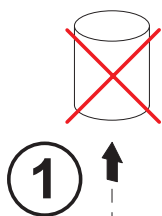

1

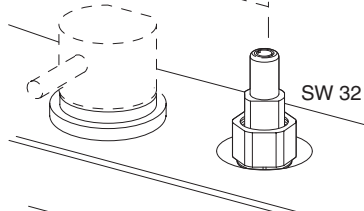

SW 32

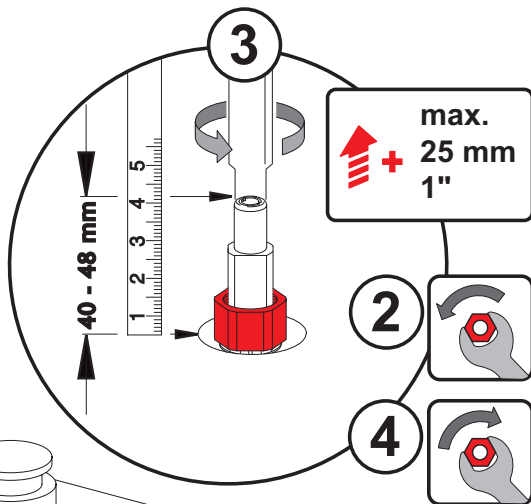

3

40 - 48 mm

max.  
25 mm  
1"

2

4

