

# QV-7000SX

Owner's Manual

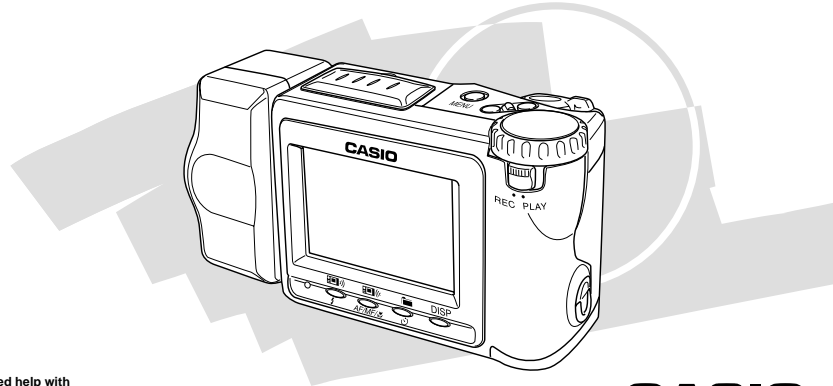

# CASIO

If you need help with your camera, please call: 1(800)435-7732

## QUICK REFERENCE

### Loading Batteries (page 27)

Be sure to load the four AA size batteries that come with the camera before using it.

**1**

On the bottom of the camera, slide the battery compartment cover lock towards the front of the camera (1) to release the cover. Grasping both sides of the battery compartment cover, swing it open (2 3).

**2**

Load batteries so their plus (+) and minus (-) ends are facing as shown in the illustration. Close the battery compartment cover (1 2), and then slide the battery compartment cover lock towards the back of the camera to lock the cover in place (3).

- Be sure to use alkaline, lithium or Ni-MH batteries. Never use manganese batteries.
- Make sure the battery compartment cover is locked securely. Failure to do so can result in the cover opening, creating the danger of personal injury and corruption of image data.

2

## QUICK REFERENCE

### Recording Images (page 37)

Be sure to perform the following operations after replacing batteries or loading batteries for the first time.

- Set the camera's built-in clock (page 34).

- 1** Slide the Function Switch to REC.
- 2** Set the dial to for normal recording.
- 3** Slide the POWER Switch in the direction indicated by arrow to turn on the camera.
- 4** After composing the image on the monitor screen, press the shutter button about half way and hold it there.
 

\* The camera's Auto Focus feature automatically focuses the image.
- 5** After confirming that the Auto Focus operation is complete (the operation indicator lights green), press the shutter button all the way down to record the image.

3

## QUICK REFERENCE

### Playing Back Images (page 67)

- 1** Slide the Function Switch to PLAY.
- 2** Slide the POWER Switch in the direction indicated by arrow.
  - The image you recorded appears on the monitor screen.
- 3** Use [+] and [-] to scroll through the images stored in camera memory.

The camera may contain pre-recorded demonstration images when you purchase it. To delete these images, see page 5.

4

## QUICK REFERENCE

### Deleting Images (page 92)

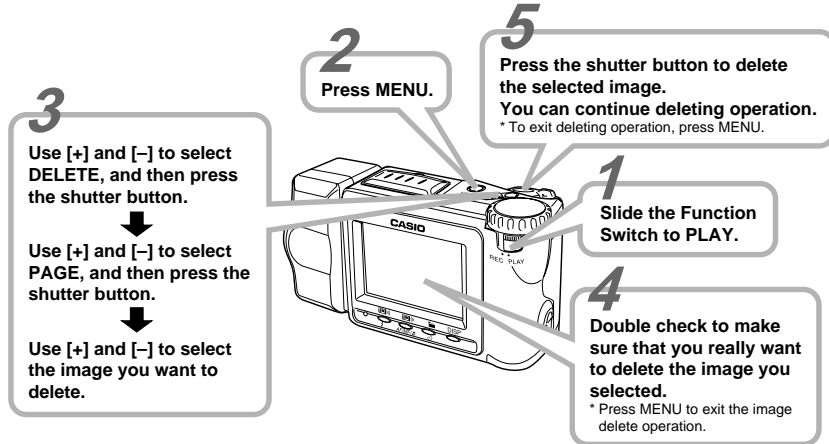

5

## CONTENTS

### INTRODUCTION

Congratulations upon your selection of the QV-7000SX LCD Digital Camera. To get the most out of the QV-7000SX, be sure to carefully read this manual and follow the instructions contained in it.

<b>2</b> QUICK REFERENCE		<b>34</b> SETTING THE CURRENT DATE AND TIME	
<b>9</b> FEATURES		To set the date and time .....	34
<b>11</b> PRECAUTIONS		To select the date format .....	35
<b>15</b> UNPACKING		<b>37</b> RECORDING	
Connecting the Strap .....	15	Using the Shutter Button .....	37
Using the Soft Case .....	17	Basic Recording Operation .....	37
<b>18</b> GENERAL GUIDE		Using Focus Lock .....	40
Top and Display .....	18	Using the Flash .....	41
Bottom .....	18	Changing the Lens Orientation .....	43
Lens .....	18	Resolution Settings .....	44
Dial .....	19	Exposure Compensation .....	45
<b>21</b> MONITOR SCREEN		<b>47</b> OTHER RECORDING FUNCTIONS	
Recording Mode .....	21	Using the Zoom Feature .....	47
Playback Mode .....	22	Manual Focus .....	49
<b>23</b> MEMORY CARDS		Using the Macro Feature .....	50
To insert a memory card into the camera .....	23	Movie Recording .....	50
To remove a memory card from the camera .....	24	Panorama Recording .....	52
Formatting a Memory Card .....	25	Sports Mode .....	53
<b>27</b> POWER SUPPLY		Night Mode .....	54
To load batteries .....	27	Sepia Recording .....	55
Using AC Power .....	30	Monochrome Recording .....	56
		Using the Self-timer .....	56
		Using the Timer .....	57
		Using the Record Menu .....	59

6

## CONTENTS

<b>67</b> PLAYBACK		<b>96</b> CONNECTIONS	
Basic Playback Operation .....	67	VIDEO OUT Terminal .....	96
Playing Back a Movie .....	68	DIGITAL Terminal .....	97
Panorama Playback .....	71	<b>98</b> CONNECTING TO OTHER EQUIPMENT	
Using Zoom .....	74	To Connect to a Television .....	98
Displaying Multiple Images .....	75	To Change the Video Output Mode .....	99
Auto Play .....	76	To Connect to a QV Color Printer .....	100
Screen Saver .....	78	Connecting to a Personal Computer .....	101
<b>80</b> EDITING IMAGES		<b>102</b> INFRARED DATA TRANSFER	
Adding a Title to an Image .....	80	Receiving Data .....	102
<b>84</b> USING FOLDERS		Sending Data .....	104
Recording an Image in a Specific Folder .....	84	Transferring Images Using PC Link Software .....	109
Selecting a Folder to Save Images .....	84	<b>111</b> USING CompactFlash CARDS WITH YOUR COMPUTER	
To Move a Single Image from One Folder to Another .....	85	Setting Up to Access CompactFlash Card Contents From Your Computer .....	111
To Move All the Contents in One Folder to Another Folder .....	87	HTML File Generator .....	114
<b>88</b> IMAGE PROTECTION		<b>118</b> TROUBLESHOOTING	
To Protect and Unprotect a Single Image .....	88	<b>122</b> MESSAGES	
To Protect and Unprotect Folders .....	89	<b>124</b> SPECIFICATIONS	
To Protect and Unprotect All Images on the Memory Card .....	91		
<b>92</b> DELETING IMAGES			
To Delete a Single Image .....	92		
To Delete All the Images in a Folder .....	94		
To Delete All Unprotected Images .....	95		

7

## CONTENTS

- CASIO COMPUTER CO., LTD. assumes no responsibility for any damage or loss resulting from the use of this manual.
  - CASIO COMPUTER CO., LTD. assumes no responsibility for any loss or claims by third parties which may arise through the use of the QV-7000SX.
  - CASIO COMPUTER CO., LTD. assumes no responsibility for any damage or loss caused by deletion of data as a result of malfunction, repairs, or battery replacement. Be sure to back up all important data on other media to protect against its loss.
  - Windows is a registered trademark of Microsoft Corporation.
  - Macintosh is a registered trademark of Apple Computer, Inc.
  - COMPACTFLASH™ and  logo are registered trademarks of SanDisk Corporation.
  - IrDA communications use Phoenix Technologies Ltd. protocol software.
- Compatibility Software Copyright (C) 1997  
Phoenix Technologies Ltd., All Rights Reserved.

8

## FEATURES

### Optical Zoom

Optical zoom lets you magnify an image to twice its normal size. Using optical zoom in combination with digital zoom lets you zoom up to 8X.

### Quick and easy dial operation

Simply rotate the dial to select the Sports Mode, Night Mode, Sepia, Monochrome, Tilt and more.

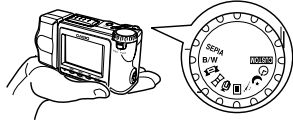

### Powerful image playback features

Playback features include Movie for animated images, Panorama for linking of multiple images into a single panorama, and Multi-Page for viewing of multiple images on a single screen.

### Setup Memory

Once you register camera settings into Setup Memory, a simple operation returns the camera to the registered settings in an instant.

### On-the-spot viewing of images as soon as you shoot them

A built-in high-definition (approximately 120,000 pixels) 2.5-inch low-glare TFT LCD provides easy viewing, even under bright light.

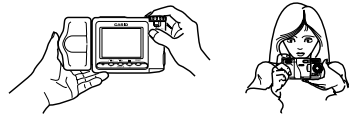

9

## FEATURES

### Memory card transfer of images to your computer

Images are recorded onto a CompactFlash memory card, which can be used to transfer images to a personal computer.



### HTML Index File

View all images, grouped by folder, on a single screen.

10

## PRECAUTIONS

### General Precautions

Be sure to observe the following important precautions whenever using the QV-7000SX.

All references in this manual to "this camera" and "the camera" refer to the CASIO QV-7000SX Digital Camera.

- Never try to take pictures or use the built-in display while operating a motor vehicle or while walking. Doing so creates the danger of serious accident.
- Never try to open the case of the camera or attempt your own repairs. High-voltage internal components create the risk of electrical shock when exposed. Always leave maintenance and repair work up to authorized CASIO service providers.
- Never fire the flash in the direction of a person operating a motor vehicle. Doing so can interfere with the driver's vision and create the danger of accident.
- Never fire the flash while it is too close to the subject's eyes. Intense light from the flash can cause eye damage if it is fired too close to the eyes, especially with young children. When using the flash, the camera should be at least one meter from the eyes of the subject.
- Keep the camera away from water and other liquids, and never let it get wet. Moisture creates the danger of fire and electrical shock. Never use the camera outdoors in the rain or snow, at the seashore or beach, in the bathroom, etc.

- Should foreign matter or water ever get into the camera, immediately turn power off, unplug the AC adaptor from the power outlet, and contact your dealer or nearest CASIO service provider. Using the camera under these conditions creates the danger of fire and electrical shock.
- Should you ever notice smoke or a strange odor coming out of the camera, immediately turn power off and unplug the AC adaptor from the power outlet. Using the camera under these conditions creates the danger of fire and electrical shock. After making sure there is no more smoke coming from the camera, take it to your nearest CASIO service provider for repair. Never attempt your own maintenance.
- If the camera's case should ever become cracked due to dropping it or otherwise subjecting it to rough treatment, immediately turn power off, unplug the AC adaptor from the power outlet, and contact your nearest CASIO service provider.
- Never use the camera inside of an air craft or in any other areas where its use is prohibited. Doing so can result in an accident.
- Physical damage and malfunction of this camera can cause the image data stored in its memory to be deleted. Be sure to always keep backup copies of data by transferring them to personal computer memory.
- Never open the battery compartment cover, disconnect the AC adaptor from the camera or unplug it from the wall socket while recording images. Doing so will not only make storage of the current image impossible, it can also corrupt other image data already stored in camera memory.

11

## PRECAUTIONS

### Operating conditions

- This camera is designed for use in temperatures ranging from 0°C to 40°C (32°F to 104°F).
- Do not use or keep the camera in the following areas.
  - In areas subject to direct sunlight
  - In areas subject to high humidity or dust
  - Near air conditioners, heaters, or other areas subject to temperature extremes
  - Inside of a closed vehicle, especially one parked in the sun
  - In areas subject to strong vibration

### Condensation

- When you bring the camera indoors on a cold day or otherwise expose it to a sudden change of temperature, there is the possibility that condensation can form on the exterior or on interior components. Condensation can cause malfunction of the camera, so you should avoid exposing it to conditions that might cause condensation.
- To keep condensation from forming, place the camera into a plastic bag before moving it into a location that is much warmer or colder than your current location. Leave it in the plastic bag until the air inside the bag has a chance to reach the same temperature as the new location. If condensation does form, remove the batteries from the camera and leave the battery compartment cover open for a few hours.

### About the camera's backlight...

- The camera is equipped with a fluorescent light source to provide the back lighting for its LCD.
- The normal service life of the backlight is approximately six years, when the camera is used for about two hours a day.
- Should the LCD image appear abnormally dark, take the camera to your dealer or an authorized CASIO service provider to have the light source replaced. Note that you will be charged for this replacement.
- Under very cold conditions, the backlight may require more time than normal to light, or reddish bands may appear in the displayed image. These conditions do not indicate malfunction, and normal operation should return at higher temperatures.

12

**PRECAUTIONS**

**Monitor Screen**

**Recording**

The image shown on the monitor screen during recording is intended for composition purposes only, so its resolution does not match that of the image as it is recorded. The image is recorded in accordance with the resolution setting made with the procedure under "Resolution Settings" on page 44. Monitor screen refresh speed varies according to the relative brightness of the subject.

**Playback**

- This camera is designed for high-speed scrolling of images during playback. Because of this, the playback image that initially appears on the monitor screen does not show the full resolution of the image as recorded. When you stop at the image you want, the monitor screen refreshes and shows the image in its full resolution.
- The message "PREVIEW" appears on a TV or CRT screen when a preview image is on the screen during output to the VIDEO OUT terminal.
- The display area of the image shown on the monitor screen is slightly smaller than the actual full image.

**Lens**

- Camera performance can be adversely affected by fingerprints or dirt on the lens surface. Never touch the lens surface with your fingers.
- Should the lens become dirty, use a blower to blow off dirt and dust, or a soft, dry cloth to wipe off the lens.
- This camera uses a telescoping type lens, which moves whenever the camera is turned on or off. Make sure nothing is blocking lens movement and never turn power on or off while the camera is laying lens down.
- Never remove batteries or disconnect the AC adaptor while the lens is extended. Doing so can cause the lens to become stuck in the extended position, resulting in camera malfunction.

**PRECAUTIONS**

**GUIDELINES LAID DOWN BY FCC RULES FOR USE OF THIS UNIT IN THE U.S.A. (not applicable to other areas).**

This device complies with Part 15 of the FCC Rules. Operation is subject to the following two conditions: (1) this device may not cause harmful interference, and (2) this device must accept any interference received, including interference that may cause undesired operation.

**NOTICE**

This equipment has been tested and found to comply with the limits for a Class B peripheral, pursuant to Part 15 of the FCC Rules. These limits are designed to provide reasonable protection against harmful interference in a residential installation. This equipment generates, uses and can radiate radio frequency energy and, if not installed and used in accordance with the instructions, may cause harmful interference to radio communications. However, there is no guarantee that interference will not occur in a particular installation. If this equipment does cause harmful interference to radio or television reception, which can be determined by turning the equipment off and on, the user is encouraged to try to correct the interference by one or more of the following measures:

- Reorient or relocate the receiving antenna.
- Increase the separation between the equipment and receiver.
- Connect the equipment into an outlet on a circuit different from that to which the receiver is connected.
- Consult the dealer or an experienced radio/TV technician for help.

**FCC WARNING**

Changes or modifications not expressly approved by the party responsible for compliance could void the user's authority to operate the equipment. Properly shielded cables with ferrite core must be used for connection to host computer and/or peripherals in order to meet FCC emission limits.

THE SPECIAL VIDEO CABLE THAT COMES WITH THE CAMERA  
 ---- THE CAMERA TO A VIDEO IN TERMINAL OF A COMPUTER  
 THE SPECIAL CONNECTION CABLE THAT COMES WITH QV-Link SOFTWARE  
 ---- THE CAMERA TO A PROPER TERMINAL OF A COMPUTER

**Declaration of Conformity**

Model Number: QV-7000SX  
 Trade Name: CASIO COMPUTER CO.,LTD.  
 Responsible party: CASIO INC.  
 Address: 570 MT. PLEASANT AVENUE,  
 DOVER, NEW JERSEY 07801  
 Telephone number: 973-361-5400

This device complies with Part 15 of the FCC Rules. Operation is subject to the following two conditions:  
 (1) This device may not cause harmful interference, and  
 (2) this device must accept any interference received, including interference that may cause undesired operation.



**UNPACKING**

Check to make sure that all of the items shown below are included with your camera. If something is missing, contact your dealer as soon as possible.



Camera



2-Way Shoulder/Wrist Strap



Soft case



Video cable



Manual

**Connecting the Strap**

**Attaching the Strap**

The two-way strap that comes with the camera can be used either as a shoulder strap or a wrist strap. Pass the wrist strap through the hole on the side of the camera as shown in the illustration.

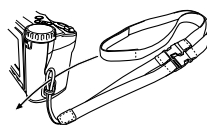

**UNPACKING**

**Using the Strap as a Wrist Strap**

Detach the upper strap from the main strap (Figure 1), and then attach the two buckles of the main strap to each other (Figure 2). Press the buckles together until they snap securely into place.

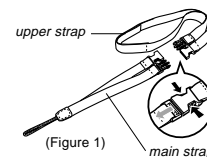

(Figure 1)



(Figure 2)

**Using the Strap as a Shoulder Strap**

Attach the strap to the camera so the shoulder pad is on the inside of the loop.

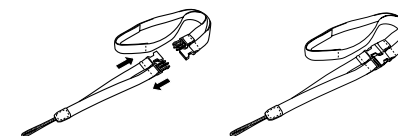

## UNPACKING

### »» IMPORTANT! ««

- Be sure to keep the strap around your wrist whenever using the camera to protect against accidentally dropping it.
- The supplied strap is intended for use with this camera only. Do not use for any other application.
- Never swing the camera around by the strap.
- Allowing the camera to swing freely from your neck can result in damage to the camera due to its bumping against other objects. It also creates the danger of the camera becoming caught in a door or on other objects, resulting in personal injury.

### Using the Soft Case

Keep the camera in its soft case to protect it when not in use.

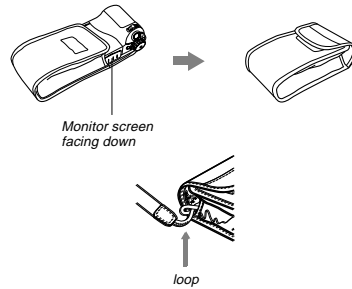

The soft case protects the camera against damage when it is dropped. Be sure to pass the strap through the loop on the soft case and keep the camera in its case when you are not using it.

17

## GENERAL GUIDE

The following illustrations show the names of each component, button and switch on the camera.

### Top and Display

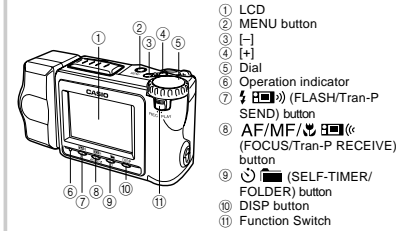

### Lens

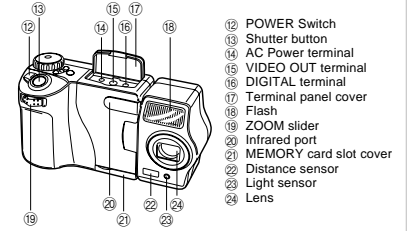

### Bottom

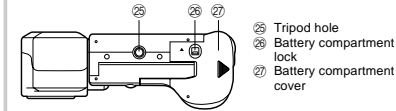

18

### Opening the Terminal Panel Cover

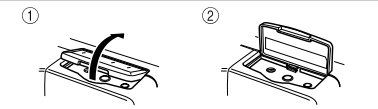

## GENERAL GUIDE

### Dial

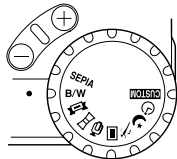

- CUSTOM** Setup ..... Selects power save, setup memory (page 32)
- Timer Recording .... For image recording using the timer (page 57)
- Night Mode ..... Enters the Night Mode. (page 54)
- Sports Mode ..... Enters the Sports Mode. (page 53)
- Normal Recording .. For normal photography (page 37)
- Movie Recording .... For selecting the movie time (page 50)

- Panorama ..... For panorama recording Recording (page 52)
- Title Recording ..... For title recording (page 80)
- B/W** Monochrome ..... For monochrome recording Recording (page 56)
- SEPIA** Sepia Recording .... For sepia recording (page 55)

### »» IMPORTANT! ««

The message "DIAL" appears on the monitor screen if the dial setting is wrong.

19

## GENERAL GUIDE

### Operation Indicator

- The operation indicator shows the operational status of the camera as described below.



Operation indicator

### Operation Indicator

#### Record Mode

Indicator Color	On	Flashing
Green	Auto Focus operation complete	Please wait (after power on)
		Image store operation in progress
Amber	Exposure warning	Flash is charging
Red	Cannot focus	Memory error
	Memory full	
	Cannot charge the flash	

#### Playback Mode

Indicator Color	On (when connecting video cable)	Flashing
Green	Playing back	Please wait (after power on)
Red	Low battery	

#### Low Battery Warning

Lights (red), after which camera power turns off automatically.

20

## MONITOR SCREEN

Pressing DISP causes various indicators to appear on the monitor screen.

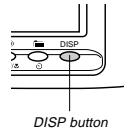

### Recording Mode

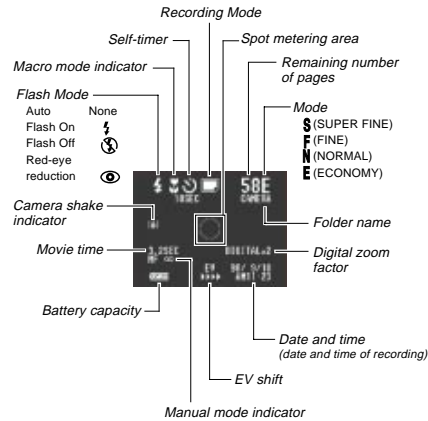

21

## MONITOR SCREEN

### Screen when shutter is pressed half way

Flash Mode ( )

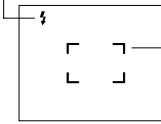

Auto Focus Frame

- Focusing complete: Green
- Focusing failed: Red/White

Flash indicator appears to indicate that flash will be fired (when auto flash is selected).

### Recording Mode Indicators

	Normal		Panorama
	Movie		Title
	Sports		Night
	SEPIA		B/W Monochrome
	Timer		

22

### Playback Mode

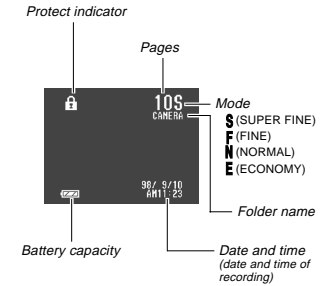

## MEMORY CARDS

This camera uses a memory card (CompactFlash cards) for image memory.

A memory card is loaded in the camera when you purchase it.

### IMPORTANT!

- Make sure that the power of the camera is turned off before you insert or remove a memory card.
- When inserting a memory card into the camera, make sure that the card is oriented correctly. Make sure that the correct side of the card is facing up, and that you insert the correct end of the card into the camera.

### To insert a memory card into the camera

- Open the memory card slot cover.

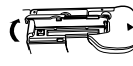

- As shown in the illustration, slide the memory card into the slot and push it in as far as it will go.

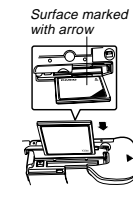

- Close the memory card slot cover.

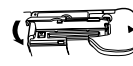

23

## MEMORY CARDS

### To remove a memory card from the camera

- Open the memory card slot cover.



- Press the eject button so it extends from the camera.

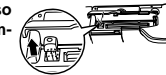

- Press the eject button once again to eject the card.

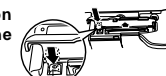

Eject button

- Remove the memory card.



- Close the memory card slot cover.

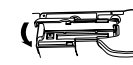

24

### NOTE

To ensure proper performance, be sure to use only CASIO brand CompactFlash cards: CF-4x (4MB), CF-8x (8MB), CF-15x (15MB), CF-30x (30MB) or CF-48x (48MB).

### IMPORTANT!

- Insert only memory cards into the memory card slot. Inserting any other type of card can cause malfunction.
- Should water or any other foreign matter get into the memory card slot, immediately turn off power, unplug the AC adaptor, and contact your original retailer or nearest CASIO Service Provider.
- Never eject the CompactFlash card while the card slot is facing downwards. Doing so creates the danger of the CompactFlash card falling, which can corrupt image data on the card.

## MEMORY CARDS

### Formatting a Memory Card

You can format a memory card to delete all of the data stored on it.

#### »» IMPORTANT! ««

- Formatting a memory card deletes all images on the card, even if some or all of the images are protected.
- Data deleted by a memory card format operation cannot be recovered! Be sure to carefully check and confirm that you no longer need the data stored in a memory card before formatting it.

### To format a memory card

1. Slide the Function Switch to PLAY.

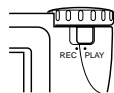

2. Press MENU.



3. Use [+] and [-] to select SETUP, and then press the shutter button.



4. Use [+] and [-] to select FORMAT, and then press the shutter button.



5. Use [+] and [-] to select FORMAT, and then press the shutter button.

25

## MEMORY CARDS

### Memory Card Precautions

- Images cannot be recorded with this camera unless a memory card is installed in it.
- Be sure to use only CASIO brand CompactFlash cards. Proper operation with other memory cards is not guaranteed.
- Static electricity, electrical noise, and other electrical phenomena can cause corruption or even total loss of the data stored on a memory card. Because of this, you should always make backup copies of important images on other media (magnetic optical disk, floppy diskette, computer hard disk, etc.).
- Memory card problems can be corrected by reformatting the memory card (page 122). Reformatting a memory card deletes all images stored on the card, but you can use a computer to copy the images you want to keep to the computer's hard disk before reformatting your card. If you plan to be recording images where you do not have access to a computer, it is a good idea to take along an extra memory card or two just in case you experience an unexpected memory card problem.

### Memory Card Folder Precautions

- Folders (directories) are automatically created if the card you are using does not already have similarly named folders (page 84).
- Up to 250 images can be stored in a single folder. Though it is possible to put more than 250 images into a folder on your computer, the camera will not display images past 250.
- Image files in camera memory are assigned names made up of the date (first five characters) plus a three-digit number and the extension JPG. Names do not change when you move or delete folders.

#### < Example >

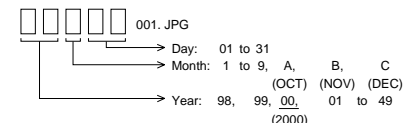

26

## POWER SUPPLY

The camera features a two-way power supply that lets you use either batteries (AA-size alkaline, lithium or Ni-MH) or household AC current.

### To load batteries

Be sure that camera power is turned off whenever loading or replacing batteries.

1. On the bottom of the camera, slide the battery compartment cover lock towards the front of the camera (①) to release the cover.

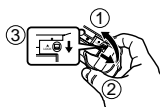

2. Grasping both sides of the battery compartment cover, swing it open (②).

3. Load batteries so their plus (+) and minus (-) ends are facing as shown in the illustration.

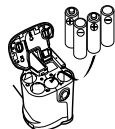

4. Close the battery compartment cover (① ②), and then slide the battery compartment cover lock towards the back of the camera to lock the cover in place (③).



Be sure to use **alkaline, lithium or Ni-MH** batteries. Never use manganese batteries (see precautions on the next page).

- Make sure the battery compartment cover is locked securely. Failure to do so can result in the cover opening, creating the danger of personal injury and corruption of image data.

27

## POWER SUPPLY

### Standard Battery Life

This camera can be powered using AA-size alkaline, lithium or Ni-MH batteries.

The battery life reference values given below indicate the amount of time at standard temperature (25°C) until power automatically turns off due to battery failure. They do not guarantee that batteries will perform the amount of service indicated. Battery life is reduced by low temperatures and continued use.

Type of Operation	AA-size Alkaline Batteries LR6	AA-size Lithium Batteries FR6	AA-size Ni-MH
Continuous Playback	80 minutes	190 minutes	110 minutes
Continuous Recording	210 shots	590 shots	360 shots

- The above figures are approximations only.
  - The above guidelines are based on the following battery types:
    - Alkaline: MX1500 (AA) DURACELL ULTRA
    - Lithium: Fuji Film
    - Ni-MH (Nickel-metal hydride): CASIO NP-H3
  - Battery life varies with brand.
  - Figures are based on continuous recording under the following conditions.
    - Flash turned off
    - One zoom slider switching between T (Telephoto) and W (Wide-angle)
- Regardless of use of the camera's flash, zoom function, turning on and off the POWER Switch, as well as other operating conditions may affect the above values.

### • About rechargeable batteries

- Use only the nickel-metal hydride batteries (NP-H3) that are available from your dealer as options for this camera. Proper camera operation is not guaranteed when other rechargeable batteries are used.
- Be sure to keep all four batteries together as a set at all times, for both charging and powering the camera. Mixing batteries from different sets can shorten overall battery life and cause malfunction of the camera.
- Rechargeable batteries cannot be charged while they are loaded in the camera.
  - Nickel-metal hydride Batteries (4-battery set)/Quick Charger Set BC-1HB4
  - Nickel-metal hydride Batteries (4-battery set) NP-H3P4

### • Tips for Prolonging Battery Life

- Use the  $\frac{1}{2}$  button to turn off the flash when you are not using it.

28

## Battery Handling Precautions

Incorrect use or handling of batteries can cause them to leak or burst and seriously damage your camera. Be sure to note the following important precautions to avoid problems with batteries.



- Use only LR6 (AM-3) type alkaline or FR6 type lithium or Ni-MH (nickel-metal hydride) dry cell batteries with this camera. Never mix old batteries with new ones. Doing so can result in bursting or leaking of batteries, creating the danger of fire or personal injury.
- Always make sure that the positive (+) and negative (-) ends of the batteries are facing correctly, as noted by the markings on the camera itself. Improper loading of batteries can result in bursting or leaking of batteries, creating the danger of personal injury or soiling of objects nearby.
- Remove batteries from the camera if you do not plan to use it for more than two weeks.
- Never recharge batteries, never allow direct connection between two ends of a battery, and never try to take batteries apart.
- Do not expose batteries to direct heat or dispose of them by burning. Doing so can create the danger of explosion.
- Never mix batteries of different types.

- Dead batteries are susceptible to leakage, which can cause serious damage to your camera. Remove batteries from the camera as soon as you notice they are dead.
- The batteries that power this camera normally become warm when they lose power. This does not indicate malfunction.

## Low Battery Indicator

The battery capacity indicator in the lower left of the monitor screen (shown only when image information display is turned on) changes to "⏏" whenever battery power goes low. If you continue to use the camera, a battery warning indicator "⚡" will appear in the center of the monitor screen, and then camera power will automatically turn off. If this happens, replace all four batteries with new ones as soon as possible.

29

## Auto Power Off (Battery Powered Operation Only)

Power automatically turns off whenever you do not perform any camera operation for a specific period. See page 32 for details about how you can specify the Auto Power Off time.

- To restore power, simply slide the POWER Switch again.

### » IMPORTANT! «

The Auto Power Off function does not operate under the following conditions.

- During Auto Play (page 76)
- While the camera is being operated from a computer or printer over a cable connection or infrared connection (page 100, 101).
- Whenever the AC adaptor is connected to the camera.

30

## Using AC Power

Use the optional AC adaptor (AD-C620) to power the camera from standard AC power.

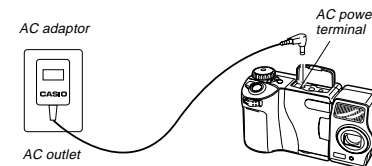

### AC Adaptor precautions

- Never use an electrical outlet whose voltage is outside the rating marked on the AC adaptor. Doing so can create the danger of fire or electrical shock. Use only the optional AC adaptor specified for this camera.
- Should the cord of the AC adaptor become damaged (exposed internal wiring), request a replacement from an authorized CASIO service provider. A damaged AC adaptor cord creates the danger of fire or electrical shock.



- Always be sure to use the AD-C620 AC adaptor only. Using any other AC adaptor can cause damage to the camera not covered by the warranty.
- When unplugging the AC adaptor from the wall socket, be sure to grasp the adaptor (not the cord).
- Avoid any undue bending, pulling, and twisting of the AC adaptor's cord, and never try to lengthen the cord by splicing it with other wire.
- Be sure to turn power off before connecting or disconnecting the adaptor.
- Always turn camera power off before disconnecting the AC adaptor, even if the camera has batteries installed. If you don't, the camera will turn off automatically when you disconnect the AC adaptor. Even so, you run the risk of damaging the camera whenever you disconnect the AC adaptor without first turning power off.
- The AC adaptor may become warm to the touch after extended periods of use. This is normal and is not cause for alarm.
- After use turn off the POWER Switch of the camera and unplug adaptor from the AC outlet.
- The camera automatically switches over to AC adaptor powered operations whenever the AC adaptor is plugged into the camera.
- Always use the AC adaptor to power the camera whenever it is connected to a computer.

31

## Power Save Settings

The settings described below let you specify sleep and auto power off trigger times that help to conserve valuable battery power.

**SLEEP** ..... The monitor screen enters a sleep state if no operation is performed for a specified amount of time in the Record Mode. Full power is restored when you press the shutter button. You can specify 30 seconds, 1 minute, or 2 minutes before the sleep state is triggered, or you can turn off this setting entirely.

**AUTO POWER OFF** ..... Auto Power Off turns off camera power if no operation is performed for a specified amount of time. You can specify 2 minutes, 5 minutes, or 10 minutes before AUTO POWER OFF is triggered, or you can turn off this setting entirely.

- AUTO POWER OFF takes priority when both SLEEP and AUTO POWER OFF are both set for a 2-minute trigger time. This means camera power turns off if no operation is performed after two minutes.

32

## To set SLEEP and AUTO POWER OFF trigger times

1. Slide the Function Switch to REC.

2. Align the dial with **CUSTOM**.



3. Use **[+]** and **[-]** to select **POWER SAVE**, and then press the shutter button.



4. Use **[+]** and **[-]** to select **SLEEP** or **AUTO POWER OFF**.



- Press the shutter button to cycle through the available settings until the one you want is on the monitor screen.
- When the settings are the way you want them, press MENU to exit the setting operation.

### Initializing Power Save Trigger Times

Use the following procedure to return SLEEP and AUTO POWER OFF trigger time settings to their initial factory defaults (SLEEP: 1 minute, AUTO POWER OFF: 2 minutes).

#### To initialize power save trigger times

- Slide the Function Switch to REC.
- Align the dial with **CUSTOM**.
  - Use [+] and [-] to select POWER SAVE, and then press DISP to initialize the power save trigger time settings.

33

## SETTING THE CURRENT DATE AND TIME

Use the following procedures to set the current date and time, and to select the date format.

When you record an image, the time and date the image was shot is registered in accordance with data from the camera's built-in clock. You can even use the TIME STAMP function to "stamp" the date and time inside the image.

#### »» IMPORTANT! ««

If you do not set the camera's built-in clock to the current date and time, all images are recorded with the default date and time, which probably is not your correct current date and time. Be sure to correctly set the clock before you use the camera.

#### To set the date and time

- Slide the Function Switch to PLAY.
- Press MENU.
- Use [+] and [-] to select **SETUP**, and then press the shutter button.



34

### SETTING THE CURRENT DATE AND TIME

- Use [+] and [-] to select **DATE**, and then press the shutter button.

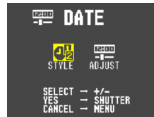

- Use [+] and [-] to select **ADJUST**, and then press the shutter button.



- Set the current date and time.
  - Use [+] and [-] to select the setting that is highlighted on the monitor screen, and then press the shutter button to advance to the next setting. Repeat this for all of the settings on the monitor screen.

- After making all the settings on the monitor screen, press MENU to register them.

#### To select the date format

Example: May 12, 1999

You can select any one of the following formats for the above date: 1999/5/12, 12/5/1999, 5/12/1999.

- Slide the Function Switch to PLAY.
- Press MENU.



- Use [+] and [-] to select **SETUP**, and then press the shutter button.



35

### SETTING THE CURRENT DATE AND TIME

- Use [+] and [-] to select **DATE**, and then press the shutter button.

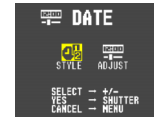

- Use [+] and [-] to select **STYLE**, and then press the shutter button.



- Use [+] and [-] to select the date format you want, and then press the shutter button.

36

# RECORDING

## Using the Shutter Button

The following steps describe how to operate the shutter button so that Auto Focus has a chance to focus the image.

### 1. Press the shutter button about half way.

- The Auto Focus feature automatically focuses the image.

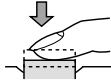

### 2. Press the shutter button as far as it will go to record the image.

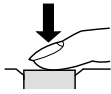

## Basic Recording Operation

The following describes the basic operation for recording images.

### 1. Slide the Function Switch to REC.

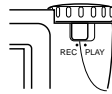

- The REC position selects the Record Mode, while PLAY selects the Playback Mode.

### 2. Rotate the dial so its (normal recording) setting is aligned with the dot on the top of the camera.

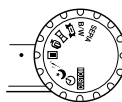

- You can perform step 2 before step 1, if you want.

### 3. Slide the POWER Switch in the direction indicated by the arrow.



37

## RECORDING

- The POWER Switch returns to its original position when you release it.
- Turning on power enters the normal Recording Mode.
- If power turns off, slide the POWER Switch again to turn it back on.

### 4. After composing the image on the monitor screen, press the shutter button about half way and hold it there.

- The camera's Auto Focus feature automatically focuses the image.
- The operation indicator lights green and the Auto Focus Frame in the monitor screen turns green when the Auto Focus operation is complete.
- Take care to avoid blocking the lens, distance sensor or light sensor with your fingers.

NO!

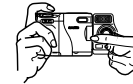

- Carefully press the shutter button, taking care not to move the camera as you do.

38

### IMPORTANT!

Auto Focus tends not to work well with the following types of subjects.

- Solid color walls or objects with little contrast
- Strongly backlit objects
- Polished metal or other brightly reflective objects
- Venetian blinds or other horizontally repeating patterns
- Multiple images that are varying distances from the camera
- Subjects in poorly lit areas
- Closeup images recorded using digital zoom

These cases may make it impossible for Auto Focus to focus properly, which is indicated by the operation indicator and the Auto Focus Frame inside the monitor screen remaining red. When this happens switch to the Manual Mode for focusing (page 49).

## RECORDING

### 5. After confirming that the Auto Focus operation is complete (operation indicator is green), press the shutter button all the way down to record the image.

- Pressing the shutter button releases the shutter, even if Auto Focus was unsuccessful and the image is out of focus.
- Images you record are stored in the CAMERA folder. See page 84 for information about how you can change to another folder to store images.
- Note that you can also select a memory card folder into which recorded images should be placed (page 84).

### CAUTION

- Never open the battery compartment cover, disconnect the AC adaptor from the camera, or unplug the adaptor from the wall socket while the operation indicator is flashing green. Doing so will not only make storage of the current image impossible, it can also corrupt other image data already stored in camera memory.
- Fluorescent lighting actually flickers at a frequency that cannot be detected by the human eye. When using the camera indoors under such lighting, you may experience some brightness or color problems with recorded images.

39

## RECORDING

### Using Focus Lock

Normally, Auto Focus automatically focuses on the object that is inside the Auto Focus Frame. Focus lock is a technique that lets you lock the focus on a subject and then move the camera so the Auto Focus Frame is pointed at another subject when you record. This keeps the original subject in focus, even though a different object is within the Auto Focus Frame.

- The Auto Focus Frame is shown on the monitor screen only while the shutter button is being held half way down.
- Locking the focus also locks the exposure setting.

### 1. Align the Auto Focus Frame with the subject you want to lock on and press the shutter button half way down.



- The Auto Focus frame turns green when the image is in focus.

### 2. While keeping the shutter button depressed half way, move the camera and compose the image as you want.



### 3. Press the shutter button all the way down to record the image.

40

## RECORDING

### Using the Flash

You can use the built-in flash unit to provide illumination during recording.

#### 1. Slide the Function Switch to REC.

#### 2. Press $\frac{1}{2}$ .

- Each press of  $\frac{1}{2}$  cycles through the flash mode in the following sequence: Auto → On → Off → Red-eye Reduction.

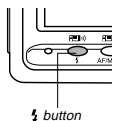

Indicator	Flash Mode	Description
None	Auto Flash	Flash is automatically enabled and disabled in accordance with exposure conditions.
$\frac{1}{2}$	Flash On	Flash is always fired, regardless of exposure conditions.
$\text{ⓧ}$	Flash Off	Flash is never fired, regardless of exposure conditions.
$\text{Ⓞ}$	Red-eye Reduction	Fires a pre-flash followed by recording with flash, which reduces the chance of red-eye.

- The monitor screen goes blank and the operation indicator flashes amber while the flash unit is charging.

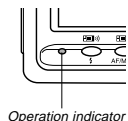

### Camera Shake Indicator

The  $\frac{1}{2}$  (camera shake indicator) appears on the monitor screen whenever flash is turned off and shutter speed is slow.

- If the camera shake indicator  $\frac{1}{2}$  appears, use the flash or use a tripod to steady the camera.
- Note that the camera shake indicator  $\frac{1}{2}$  does not appear in the Night Mode (page 54).

### Flash Indicator

When you press the shutter button half way, the flash icon appears on the monitor screen to indicate that the flash will fire when shutter button is pressed the rest of the way down.

41

## RECORDING

### IMPORTANT! $\lll$

- Never use the flash in areas where combustible or explosive gas is present. Doing so creates the danger of fire and explosion.
- Never fire the flash in the direction of a person operating a motor vehicle. Doing so can interfere with the driver's vision and create the danger of accident.
- Never fire the flash while it is too close to the subject's eyes. Intense light from the flash can cause eye damage if it is fired too close to the eyes, especially with young children. When using the flash, the camera should be at least one meter (40") from the eyes of the subject.
- Make sure that you do not touch or block the flash or light sensor with your fingers. Doing so can soil these components and interfere with correct flash operation.
- Flash should be used for distances within the range of about 0.7 meters to 2 meters (2.3 to 6.6'). Flash does not work well outside this range.
- Depending on operating conditions (type of battery being used, temperature, etc.), it may take up to 10 seconds for the flash unit to charge.
- The flash is disabled during movie recording. The  $\text{ⓧ}$  indicator flashes to indicate this condition.

- The flash unit will not charge when battery power is low. The  $\text{ⓧ}$  indicator flashes red to warn you that the flash will not fire correctly, which may affect exposure of the image. Replace batteries as soon as possible when this happens.
- Red-eye reduction may not work well when the camera is not pointed directly at the subject or when the subject is far from the camera.
- In the Red-eye Reduction Mode, the flash is fired automatically in accordance with exposure. Because of this, the flash will not fire in a well-lit area.
- White balance is fixed while the flash is being used, so the coloring of the recorded image may be affected by sunlight, fluorescent lighting, or other sources of illumination in the immediate area.

42

## RECORDING

### Changing the Lens Orientation

The lens of the camera is built into a lens body that is designed to rotate. This means you can change the angle of the lens without moving the rest of the camera.

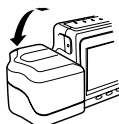

Rotates up to 90° towards the front



Rotates up to 180° towards the back

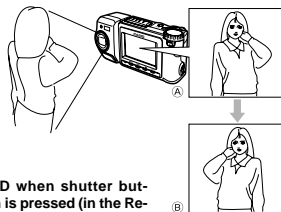

- (A) ..... LCD when shutter button is pressed (in the Record Mode)
- (B) ..... LCD when image is played back from camera memory

### IMPORTANT! $\lll$

- Do not apply excessive force when rotating the lens body. Doing so can cause serious damage to the lens.
- Do not carry the camera or move it around while holding onto only the lens body.
- Return the lens body to its normal position (with the lens pointing from the front of the camera) before storing the camera.

43

## RECORDING

### Resolution Settings

The camera has four resolution modes: SUPER FINE ( $\text{Ⓢ}$ ), FINE ( $\text{ⓕ}$ ), NORMAL ( $\text{Ⓝ}$ ), ECONOMY ( $\text{ⓔ}$ ).

- To determine the number of images that can be stored on a memory card of a different capacity, multiply the capacities in the table by the appropriate value.
- The actual number of images that can be stored in memory cannot be specified precisely because the amount of memory required for storage of each image differs according to image contents.

Setting Indicator	$\text{Ⓢ}$	$\text{ⓕ}$	$\text{Ⓝ}$	$\text{ⓔ}$
Resolution	SUPER FINE	FINE	NORMAL	ECONOMY
Number of Images 8MB memory card	14	19	33	55
Number of Images 48MB memory card (option)	88	123	206	340
File Size (per image)	500KB	350KB	200KB	112KB
Computer Output image	1280 x 960 pixels	1280 x 960 pixels	1280 x 960 pixels	640 x 480 pixels

- Numbers in parentheses are compressed image file sizes.
- The figures in the left are approximations only. The actual number of images depends on image subject matter. Use the procedure under "Using the Record Menu" on page 59 for details on changing the resolution modes.
- Note that the maximum number of images that can be stored in a single folder is 250. Because of this, even if you are using a card that allows storage of more than 250 images, the camera's monitor screen will show capacity for up to 250 images only. You will be able to store the additional images by changing to another folder.
- The number of images that can be recorded may be less when HTML file generation is turned on (page 114).

44

### Exposure Compensation

This camera features an program AE function that automatically changes shutter speed and aperture in accordance with available light. In addition, you can also manually adjust the exposure to compensate for backlighting, indirect indoor lighting, dark backgrounds, and other special conditions.

#### To manually adjust the exposure

##### 1. Set the Function Switch to REC.

##### 2. Use [+] and [-] to perform exposure compensation.

- Pressing [+] or [-] displays an EV indicator that shows the current exposure compensation setting.
- Pressing [+] makes the image on the LCD brighter. Use it to adjust for dim indoor lighting and backlighting.
- Pressing [-] makes the image on the LCD darker. Use it to adjust for bright sunlight.
- The EV indicator turns red whenever the compensation value is at its limit.

##### 3. After adjusting the exposure, press the shutter button to record the image.

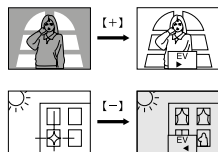

#### »» NOTES ««

- Exposure compensation is generally expressed in terms of an exposure compensation (EV) value. The exposure compensation value is always set to zero whenever you turn on the camera.
- Each press of [+] or [-] changes the exposure compensation value by 0.25EV. A change in either direction is indicated on the monitor screen by arrows pointing left (negative correction) or right (positive correction).
- The normal maximum range for exposure compensation is -2EV to +2EV. Under certain conditions, however, the camera may impose lower maximum values when exposure compensation would result in an image that is too dark or too light.

45

- The exposure compensation value automatically reverts to zero whenever the shutter button is pressed. You can manually reset the exposure compensation value by using [+] and [-] to change the value back to zero, which is indicated when the EV indicator disappears from the monitor. EV value is fixed during panorama recording.
- Shutter speed and aperture is fixed whenever you manually adjust the exposure setting.

46

## OTHER RECORDING FUNCTIONS

This section describes more advanced recording operations that are also provided by this camera.

### Using the Zoom Feature

The zoom features let you move in closer on subjects that are located far from the camera. You can choose either optical zoom or digital zoom, or even use them in combination to increase the size of the original image by four or eight times its original size.

#### Using Optical Zoom

Optical zoom enlarges the image by changing the focal distance of the lens. You can increase the double the size of the image using optical zoom.

#### »» IMPORTANT! ««

- For Optical Zoom recording, first perform the zoom operation and then move the camera towards the subject. Otherwise the lens can be damaged by coming into contact with the subject when it extends from the camera during the zoom operation.
- Do not carry the camera around or leave it laying around with the lens extended.

##### 1. Slide the Function Switch to REC.

##### 2. Moving ZOOM slider towards T (telephoto) to zoom in on the subject, or W (wide-angle) to zoom out.

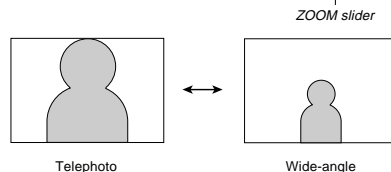

##### 3. Compose the image on the monitor screen, and then press the shutter button about half way.

47

##### 4. After confirming that the Auto Focus operation is complete, press the shutter button all the way down to record the image.

- Brightness (aperture) is also affected by using optical zoom.

#### Using Digital Zoom

Digital zoom produces a VGA size image (640 x 480 pixels) that can be double or four times the size of the original image.

Using digital zoom and optical zoom in combination can zoom an image to 8X.

#### »» IMPORTANT! ««

- The focus range for Auto Focus depends on the digital zoom setting as shown below.

Digital Zoom	Focus Range
OFF	0.25m to ∞ (0.8' to ∞)
2X	0.6m to ∞ (2.0' to ∞)
4X	1.5m to ∞ (5.0' to ∞)

- The camera may not be able to focus on an image within the Auto Focus frame if the subject is closer than the distances noted above. In such a case, the Auto Focus frame changes to white when you press the shutter button half way.
- Note that 4X digital zoom produces a relatively rougher image than OFF or 2X when used in combination with Auto Focus.

See "Using the Record Menu" on page 59 for details on making digital zoom settings.

48

## Manual Focus

Manual Focus lets you manually adjust the focus of an image.

- Manual focus is indicated by the MF indicator on the monitor screen.

## 1. Slide the Function Switch to REC.

## 2. Press AF/MF/☺ a number of times until the MF indicator appears on the monitor screen.

- Each press of AF/MF/☺ cycles the focus mode in the following sequence: Auto Focus → Manual Focus (MF) → Macro (☺).

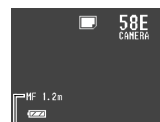

Manual Focus indicator

## 3. Manually measure the distance to the subject, and then press [+] or [-].

- This causes the current focus distance to appear on the screen.

## 4. Use [+] and [-] to increase or decrease the distance value on the monitor screen, until the one closest to distance you measured in step 3 is displayed.

## 5. Press the shutter button.

- The operation indicator and the Auto Focus frame do not appear while manual focus is in use.

49

## Using the Macro Feature

With the macro feature, you can record close up images of subjects locate only 10cm (4") from the lens.

- ☺ is shown on the monitor screen when the macro feature is turned on.
- Auto Focus is disabled while the Macro feature is in use.

## To record an image using the macro feature

## 1. Slide the Function Switch to REC.

## 2. Press AF/MF/☺ a number of times until the ☺ indicator appears on the monitor screen.

- Each press of AF/MF/☺ cycles the focus mode in the following sequence: Auto Focus → Manual Focus (MF) → Macro (☺).

Macro setting



## 3. After composing the image on the monitor screen, press the shutter button all the way down to record the image.

50

## 3. Compose the image on the monitor screen and then press the shutter button about half way.

- Auto Focus automatically adjusts in accordance with the movement of the subject.

## 4. After confirming that the Auto Focus operation is complete (operation indicator is green), press the shutter button all the way down to record the image.

- See "Playing Back a Movie" on page 68 for details on playing back a movie.

## 4. Keep the camera pointed at the action you want to record, and press the shutter button all the way down when you want to end recording.

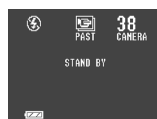

- If you selected a movie length of 12.8 seconds, for example, pressing the shutter button records everything that went on in front of the lens from about 12.8 seconds ago up to the point you pressed the shutter button.

## PAST

## 1. Slide the Function Switch to REC.

## 2. Align the dial with ☺ to select Movie Recording Mode.

## 3. Compose the image on the monitor screen and then press the shutter button about half way.

- Auto Focus automatically adjusts in accordance with the movement of the subject.

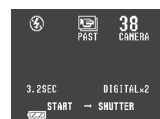

51

## IMPORTANT!

- Flash is disabled during movie recording.
- A movie uses four images worth of memory, regardless of the movie length.

	Frames Per Second	Images Per Frame	Memory Used
3.2 seconds	5	4	4
6.4 seconds	10	16	4
12.8 seconds	5	16	4

- Movie images that are uploaded to a personal computer and then download back to the camera cannot be played back as a movie. Uploading a movie image to a computer ungroups it, so you will not be able to play it back when you download it back to the camera unless you re-group them using the procedure on page 69.
- Entering the Movie Mode for recording automatically applies digital zoom. You can also use digital zoom in combination with optical zoom.
- During movie recording, Auto Focus is performed in accordance with the movement of the subject.

52

## Movie Recording

You can record movies that are approximately 3.2, 6.4, or 12.8 seconds long.

There are two types of movie recording: PAST and FUTURE. PAST lets you capture images of events that occurred before you pressed the shutter button while FUTURE records what happens after you press the shutter button.

See "Using the Record Menu" on page 59 for details on how to select the movie length and recording type.

## FUTURE

## 1. Slide the Function Switch to REC.

## 2. Align the dial with ☺ to select Movie Recording Mode.

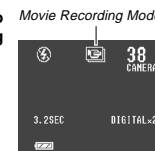

## Panorama Recording

With panorama recording you record a series of images and then link them to create a single panoramic effect.

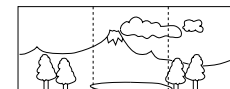

## 1. Slide the Function Switch to REC.

## 2. Align the dial with ☺ to select Panorama Recording Mode.

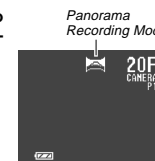

## 3. Compose the image on the monitor screen and then press the shutter button about half way.

Panorama Recording Mode

#### 4. After confirming that the Auto Focus operation is complete (operation indicator is green), press the shutter button all the way down to record the image.

- The right edge of the previous image you recorded remains on the monitor screen, so you can align it correctly with the next image.
- From the second image onwards, aim the camera further to the right and overlap the next image with the previous one on the monitor screen.
- Up to nine images can be grouped into a panorama. Press MENU when you want to stop a panorama recording operation.
- If you want to link more than 9 images into a panorama, upload the images to a computer and use your computer application to link them.
- Aperture setting and white balance settings are locked when you record the first image of a panorama, and these settings are applied to all subsequent images in that panorama.
- See "Panorama Playback" on page 71 for details on playing back panoramas.

#### Sports Mode

The sports mode makes it possible to capture sharp recordings of moving objects.

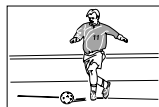

1. Slide the Function Switch to REC.
2. Align the dial with .



53

#### 3. Compose the image on the monitor screen, and then press the shutter button about half way.

- Auto Focus continues to update in accordance with the movement of the subject while the shutter button is pressed half way.
- The operation indicator and the Auto Focus frame do not appear in the sports mode.

#### 4. Press the shutter button all the way down to record the image.

- When available light is dim, the shutter slows down to the same speed used for normal (non-Sports Mode) recording.

#### Night Mode

The Night Mode is for recording images in dark areas.

- Using the Night Mode in combination with the flash records the image in slow synchro.



#### 1. Slide the Function Switch to REC.

#### 2. Align the dial with .

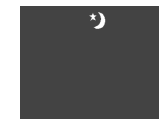

#### 3. Compose the image on the monitor screen, and then press the shutter button about half way.

54

#### 4. After confirming that the Auto Focus operation is complete (operation indicator is green), press the shutter button all the way down to record the image.

- When recording images of people on a twilight or night time background, you can use the flash in combination with the Night Mode for slow synchro recording.

#### »» IMPORTANT! ««

- The shutter speed is quite slow in the Night Mode, so you should be sure to use a tripod to hold the camera steady. Note that the camera shake indicator does not appear in the Night Mode.
- Slow shutter speed also causes slow monitor screen refresh. Because of this, the image recorded may be slightly different from the image that was on the monitor screen when you pressed the shutter button.
- Auto Focus is difficult in the dark. If you experience problems, use manual focusing (page 49). There may be some blurring of the image if the subject is fast moving.

#### Sepia Recording

The Sepia Mode records images in sepia tone.

1. Slide the Function Switch to REC.
2. Align the dial with SEPIA.



#### 3. Compose the image on the monitor screen, and then press the shutter button about half way.

#### 4. After confirming that the Auto Focus operation is complete (operation indicator is green), press the shutter button all the way down to record the image.

- An image recorded in sepia cannot be converted to a color image.

55

#### Monochrome Recording

The Monochrome Mode records images in black and white.

1. Slide the Function Switch to REC.
2. Align the dial with B/W.



#### 3. Compose the image on the monitor screen, and then press the shutter button about half way.

#### 4. After confirming that the Auto Focus operation is complete (operation indicator is green), press the shutter button all the way down to record the image.

- An image recorded in monochrome cannot be converted to a color image.

#### Using the Self-timer

You can use the self-timer for either of the two following recording operations.

**10-second recording ....** Records about 10 seconds after the shutter button is pressed. Use this method when you want to be included in the image that is recorded.

**2-second recording .....** Records about two seconds after the shutter button is pressed. Use this method to avoid camera movement caused when the shutter button is pressed.

#### To record an image using the self-timer

#### 1. Slide the Function Switch to REC.

#### 2. Press .

- Each press of  cycles the self-timer in the sequence: 10 → 2 → Off.

Self-timer setting



56

3. After composing the image on the monitor screen, press the shutter button about half way and hold it there to activate Auto Focus.

4. After confirming that the Auto Focus operation is complete (operation indicator is green), press the shutter button all the way down to start the self-timer.

#### NOTE

During self-timer recording, you may find it helpful to rotate the swivel lens mechanism 180 degrees so the monitor screen faces the same direction as the lens. This way you can always see how much time is left until the start time is reached and recording begins.

#### Using the Timer

You can use the timer to perform any one of the following operations.

- **Interval Recording**  
Use this method to record a series of images at fixed time intervals.
- **Timer Recording**  
Use this method to record a single image after passage of a fixed amount of time.
- **Interval Timer Recording**  
Use this method to record a series of images at fixed time intervals, starting after passage of a fixed amount of time.

#### To record using timer recording

1. Mount the camera onto a tripod.
2. Slide the Function Switch to REC.
3. Align the dial with  to select timer recording.



57

4. Use [+] and [-] to select the number of shots you want to record, and then press the shutter button.

- If you specify 1 as the number of shots, skip step 5 and jump directly to step 6.

5. Use [+] and [-] to select the interval between shots, and then press the shutter button.

- You can specify an interval of from 1 to 60 minutes, in 1-minute steps.

6. Use [+] and [-] to select the start time of the record operation, and then press the shutter button.

- You can specify any amount of time up to 24 hours from the present.

7. After composing the image on the monitor screen, press the shutter button about half way and hold it there to activate Auto Focus.

8. After confirming that the Auto Focus operation is complete (operation indicator is green), press the shutter button all the way down to record the image.

- When the start time you set is reached, the operation indicator lights and image recording starts.

58

#### Turning on Power During a Timer Operation

The monitor screen of the camera turns off between shots of a timer operation. If you turn on camera power during this time, the message shown below appears and the timer operation is cancelled.



#### Using the Record Menu

Normally, the camera's automatic features and functions provide the best image recording results. The Record Menu lets you set up the camera manually when you want to compensate for special conditions or produce particular creative effects.





#### NOTE

You can also set up the camera to save certain Record Menu settings in mode memory when you turn off camera power (page 63). The saved settings are restored the next time you turn on the camera.

The following is a complete list of items whose settings you can change in the Record Menu.

**QUALITY** ..... **S** (SUPER FINE), **F** (FINE), **N** (NORMAL), **E** (ECONOMY)

**S** (SUPER FINE) provides best image quality, but it also takes up most memory. See "Resolution Settings" on page 44 for details.

**WB** ..... AWB, , , , , MWB

**(White Balance)** White balance adjusts the white portions of the image to make its coloring more natural.

59

 ..... Select when available light is reddish.

 ..... Select when available fluorescent light is greenish.

 ..... Select for outdoor recording.

 ..... Select when available twilight is bluish.

**MANUAL** .. Recording with available (MWB) light.

See "Performing Manual White Balance" on page 62 for details.

**APERTURE** ..... AUTO, F2.8, F5.6, F11

The above aperture settings are indicated on the monitor screen. Actual aperture is different from the indicated value while optical zoom is being used.

Indicated Aperture	Actual Aperture Range (Wide Angle to Telephoto)
F2.8	F2.8 to F3.5
F5.6	F5.6 to F7
F11	F11 to F14

**DIGITAL ZOOM** .. AUTO, 2X, 4X, OFF

Images are always recorded in **E** (ECONOMY) resolution (640 x 480 pixels) whenever digital zoom is used.

When Auto is selected for DIGITAL ZOOM, moving the ZOOM slider towards T automatically changes the digital zoom setting to 2X or 4X. Moving the slider towards "W" turns off digital zoom.

**MOVIE MODE** .... FUTURE, PAST

See "Movie Recording" on page 50 for details about movies.

**MOVIE TIME** ..... 3.2, 6.4, 12.8 seconds

See "Movie Recording" on page 50 for details about movies.

**METERING** ..... Multi metering, spot metering

**(Light Metering)** **MULTI** ..... Divides the image into sections and measures the light in each section for a balanced exposure reading.

60

**SPOT** ..... Measures light in a limited area in the center of the image. Use this setting when you want exposure to be in accordance with the lighting of the subject itself, without being affected by the lighting around the periphery of the subject.

**SHARPNESS** ..... SOFT, NORMAL, HARD  
This setting is used when recording portraits to control outlines.  
SOFT ..... Select for a soft image.  
HARD ..... Select for a sharp image.

**TIME STAMP** ..... This setting controls whether or not a time is imprinted inside the image. Turning on this feature causes the current date to be "stamped" on the recorded image. The date cannot be removed once it is stamped.

**FOLDER** ..... Use this setting to select a folder in which to store a recorded image.

## To make Record Menu settings

### 1. Slide the Function Switch to REC.

### 2. Press MENU.

- MENU is disabled while the dial is set to **CUSTOM** or **Ⓢ**. If nothing happens when you press MENU, change the dial setting.



### 3. Use [+] and [-] to select the item whose setting you want to change, and then press the shutter button.



61

## 4. Use [+] and [-] to select the setting you want and then press the shutter button.

- If you want to change other settings, press MENU and then repeat steps 3 and 4.
- The QUALITY, MOVIE MODE, and MOVIE TIME settings you make are always retained, even when you turn off the camera.
- For the WB, APERTURE, DIGITAL ZOOM, and METERING settings, you can use the procedure under "Customizing Record Mode Power On Settings" on page 63 (specify whether or not settings should be retained when camera power is turned off).

## Performing Manual White Balance

Certain lighting conditions can cause Auto white balance to take a very long time or can result in a limitation of the adjustable range (color temperature). If you suspect your current lighting conditions are causing problems, try performing manual white balance. This sets white balance to a level that can be used under any lighting conditions.

The following procedure describes how to perform manual white balance using a white piece of paper. For optimum results, you should use a special reflective plate that should be commercially available from a local camera equipment shop.

### 1. Slide the Function Switch to REC.

### 2. Press MENU.



62

### 3. Use [+] and [-] to select WB, and then press the shutter button.



### 4. Use [+] and [-] to select MWB, and then press the shutter button.



### 5. Press MENU to start manual white balance setting.

- Keep the camera pointed at the white piece of paper.
- Pressing the shutter button at this time returns the camera to the white balance setting that was obtained the last time you performed this manual white balance procedure.

### 6. The manual white balance procedure stops automatically when it is done.

- If the manual white balance procedure does not end automatically, press the shutter button to interrupt it.

### 7. After the camera finishes making the white balance setting, it returns to the screen shown in step 4 above. Press the shutter button to exit the manual white balance procedure.

## Customizing Record Mode Power On Settings

A power on setting is one that is set by the camera automatically whenever you turn it on. Normally, the camera uses its own built-in power on default settings. With the procedure described here, however, you can tell the camera to save the camera's current WB (white balance), APERTURE, DIGITAL ZOOM, FLASH, AF/MF/MACRO, and METERING settings in mode memory when it is turned off, and to restore the setting when power is turned on again. Settings stored in mode memory override the camera's preset defaults. The following table shows the items whose settings you can save in mode memory. Note that the procedure described here only lets you select ON (save current setting in mode memory) or OFF (use the camera's preset default setting). The procedures for changing current settings can be found on the pages noted in the table.

The following table shows the items whose settings you can save in mode memory. Note that the procedure described here only lets you select ON (save current setting in mode memory) or OFF (use the camera's preset default setting). The procedures for changing current settings can be found on the pages noted in the table.

Item	ON	OFF (camera preset)
<b>WB</b>	Current Manual Mode white balance setting (page 59).	AUTO
<b>APERTURE</b>	Current Manual Mode aperture setting (page 60).	AUTO
<b>DIGITAL ZOOM</b>	Current Manual Mode digital zoom setting (page 60).	OFF
<b>FLASH</b>	Current flash mode setting (page 41).	AUTO
<b>AF/MF/MACRO</b>	Current focus mode setting: Auto Focus, Manual Focus (page 49), or Macro Mode (page 50).	AF
<b>METERING</b>	Current Manual Mode metering setting (page 60).	MULTI

## To turn power on default settings on and off

### 1. Slide the Function Switch to REC.

### 2. Align the dial with **CUSTOM**.



### 3. Use [+] and [-] to select MODE MEMORY and then press the shutter button.



### 4. Use [+] and [-] to select the item you want, and then press the shutter button to toggle it on and off.

- Turning an item on stores its current setting in mode memory when the camera is turned off, while turning an item off tells the camera to use its preset default setting.

63

64



- Repeat step 4 for other items, if you want.
- After the on/off status of each item is the way you want it, press MENU.

### Initializing Mode Memory

Use the following procedure to initialize the mode memory.

#### To initialize mode memory

- Slide the Function Switch to REC.

- Align the dial with **CUSTOM**.



- Use **[+]** and **[-]** to select **MODE MEMORY**, and then press **DISP** to initialize mode memory.

- The following table shows the mode memory status of each item following the above procedure.

65

Item	Initialized Setting
WB	OFF
APERTURE	OFF
DIGITAL ZOOM	OFF
FLASH	ON
AF/MF/MACRO	OFF
METERING	ON

- An item that is ON stores its current setting in mode memory when camera power is turned off, and restores the setting when power is turned back on again.
- An item that is OFF uses the camera's preset power on default setting.

66

## PLAYBACK

The following describes the different techniques that you can use to playback recorded images.

### Basic Playback Operation

The built-in monitor screen of the camera lets you play back recorded images without connecting an external monitor.

- Slide the Function Switch to **PLAY**.

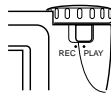

- The PLAY position selects the Playback Mode, while REC selects the Record Mode.

- Use **[+]** and **[-]** to scroll through the images stored in camera memory.

- Press **[+]** to scroll forward and **[-]** to scroll back. Holding down either button scrolls at high speed.



#### »» NOTES ««

- Sliding the Function Switch to PLAY immediately after recording an image displays the image you just recorded first.
- Pressing the shutter button while a movie or panorama image is on the monitor screen starts playback of the movie or panorama.
- The image that initially appears on the monitor screen in the PLAY mode is a preview image. The full of image appears after a few seconds.

67

### Playing Back a Movie

Use the following operation to play back a movie that was recorded using the operation under "Movie Recording" on page 50.

- Slide the Function Switch to **PLAY**.

- Use **[+]** and **[-]** to select the movie you want to play back.



- Press the shutter button to start playing back the movie.

- You can use **[+]** (forward) and **[-]** (reverse) while playing back a movie to change the playback direction.
- To enlarge the movie image so it fills the entire monitor screen, press DISP. Pressing the DISP again returns the image to its original small size.
- Pressing the shutter button during movie play pauses playback. Press the shutter button again to resume playback.

- While movie playback is paused, you can use **[+]** (forward) and **[-]** (reverse) to move frame-by-frame through the movie.

- After the movie is complete, press MENU.

68

## Regrouping Movie Images

When you record a movie, the camera automatically groups four images that make up the movie. Transferring a movie to a personal computer causes its images to become ungrouped. If you download the movie back to the camera, you will be unable to play it back as a movie unless you use the following procedure to re-group the images.

### To re-group movie images

1. Slide the Function Switch to PLAY.
2. Use [+] and [-] to display the first of the four images that make up the movie you want to re-group.

3. Press MENU.



4. Use [+] and [-] to select TOOL, and then press the shutter button.

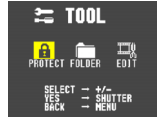

5. Use [+] and [-] to select EDIT, and then press the shutter button.



69

6. Use [+] and [-] to select MOVIE, and then press the shutter button.



7. Use [+] and [-] to select GROUPING, and then press the shutter button.



8. Use [+] and [-] to scroll through the other images that make up the movie until the one you want to use as the final image is on the display.

9. Press the shutter button to re-group the movie images.

- The movie playback screen (page 68) appears after the re-grouping operation is complete.

70

## To ungroup movie images

1. Perform steps 1 through 6 under "To re-group movie images" on page 69.

2. Use [+] and [-] to select CANCEL GROUPING, and then press the shutter button.



3. Use [+] and [-] to select the movie you want to ungroup, and then press the shutter button.

- The above step ungroups the movie images and displays the next movie in the current folder. You can repeat step 3 to ungroup more movies, or you can press MENU to terminate the procedure.
- The above procedure is terminated automatically if there are no more movies in the current folder.

## Panorama Playback

Use the following operation to playback panoramas recorded using the operation under "Panorama Recording" on page 52.

1. Slide the Function Switch to PLAY.

2. Use [+] and [-] to select the panorama you want to play back.

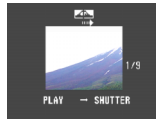

3. Press the shutter button to start panorama playback.



- You can change the direction of a panorama that is playing back by pressing [+] or [-].
- To enlarge the panorama image so it fills the entire monitor screen, press DISP. Pressing the DISP again returns the image to its original small size.

- Pressing the shutter button during panorama play pauses playback. Press the shutter button again to resume playback.

- While panorama playback is paused, you can use [+] (forward) and [-] (reverse) to move frame-by-frame through the panorama.

4. Press MENU to stop panorama playback.

71

## Regrouping Panorama Images

Transferring a panorama to a personal computer causes its images to become ungrouped. If you download the panorama back to the camera, you will be unable to play it back as a panorama unless you use the following procedure to re-group the images.

### To re-group panorama images

1. Slide the Function Switch to PLAY.

2. Use [+] and [-] to display the first of the images that make up the panorama you want to re-group.

3. Press MENU.



4. Use [+] and [-] to select TOOL, and then press the shutter button.



5. Use [+] and [-] to select EDIT, and then press the shutter button.



6. Use [+] and [-] to select PANORAMA, and then press the shutter button.



72

7. Use [+] and [-] to select **GROUPING**, and then press the shutter button.



8. Use [+] and [-] to scroll through the other images that make up the panorama until the one you want to use as the final image is on the display.

9. Press the shutter button to re-group the panorama images.

- The panorama playback screen (page 71) appears after the re-grouping operation is complete.

### To ungroup panorama images

1. Perform steps 1 through 6 under “To re-group panorama images” on page 72.

2. Use [+] and [-] to select **CANCEL GROUPING**, and then press the shutter button.



3. Use [+] and [-] to select the panorama you want to ungroup, and then press the shutter button.

- The above step ungroups the panorama images and displays the next panorama in the current folder. You can repeat step 3 to ungroup more panoramas, or you can press MENU to terminate the procedure.
- The above procedure is terminated automatically if there are no more panoramas in the current folder.

73

### Using Zoom

The following operation lets you magnify an image to twice its normal size. Note that you can zoom only a single still image.

#### IMPORTANT!

Movie and panorama images cannot be zoomed.

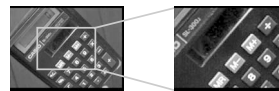

- Slide the Function Switch to **PLAY**.
- Use [+] and [-] to select the image you want to zoom in.
- Press **MENU**.



74

4. Use [+] and [-] to select **VIEW**, and then press the shutter button.

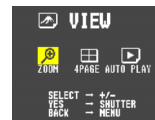

5. Use [+] and [-] to select **ZOOM**, and then press the shutter button.

- This magnifies the center part of the image to twice its normal size.

6. Use [+] and [-] to slide the image so you can view the part of it that you want.

7. After you are finished, press any button besides [+], [-], or DISP return the image to its normal size.

### Enlarged Image Movement

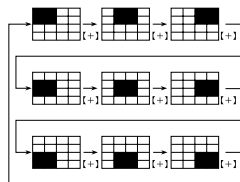

- Pressing [-] slides the image in the opposite direction.

#### NOTE

Zooming an image while image information is turned on (page 21), an image part indicator  appears in the upper right corner to indicate which part of the image is currently on the screen. Display of the image part indicator can be toggled on and off by pressing DISP.

### Displaying Multiple Images

The following operation lets you simultaneously view four images on the same screen. This capability is especially useful when playing back to the screen of a connected TV, and can be used to display a catalog of products, etc.



- Slide the Function Switch to **PLAY**.
- Press **MENU**.



75

3. Use [+] and [-] to select **VIEW**, and then press the shutter button.

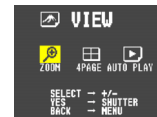

4. Use [+] and [-] to select **4PAGE**, and then press the shutter button.

- The first image of the set is the image that was on the screen when you performed step 2 of this operation. The other images are those that sequentially follow the first one.

5. Use [+] and [-] to scroll through images stored in memory.



6. After you are finished, press any button besides [+], [-], or DISP return to the normal single-image display.

### Auto Play

Auto Play automatically scrolls through the images stored in memory. You can also specify how much time should be allowed between each image.



#### IMPORTANT!

Auto Power Off (page 30) is disabled whenever Auto Play is being used. This means you should not leave Auto Play running when using batteries to power the camera. Doing so can rundown batteries. Be sure to stop Auto Play and turn off the camera after you are finished.

76

## To start Auto Play

1. Slide the Function Switch to PLAY.
2. Press MENU.



3. Use [+] and [-] to select VIEW, and then press the shutter button.

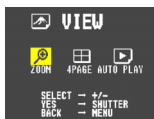

4. Use [+] and [-] to select AUTO PLAY, and then press the shutter button.

5. To stop Auto Play, press any button besides MENU.

- Note that all buttons are disabled while an image change is in progress. Wait until an image is stopped on the monitor screen before performing a button operation, or hold down the button until the image stops.

77

## Setting the Auto Play Interval

You can use the following operation to set the amount of time that should be allowed between each image during Auto Play (the Auto Play interval).

1. Start Auto Play using the operation under “To start Auto Play” on page 77.

2. Press MENU.

- Be sure to wait for the image on the screen to stop before performing any button operation.

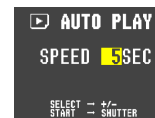

3. Use [+] and [-] to set the Auto Play interval value you want and then press the shutter button.

- You can set the Auto Play interval to any value in the range of 5 to 30 (seconds).
- After you make the above setting, Auto Play resumes using the interval you set.

78

## Screen Saver

The screen saver function automatically activates Auto Play (which automatically scrolls through images) whenever you do not perform any operation for about five minutes in the Playback Mode. This protects the camera's monitor screen and the screen of a connected TV against "burn in" of a static image that is left displayed too long.

### IMPORTANT!

- The screen saver is enabled only when the camera is being powered by its optional AC adaptor. If you do not perform any operation for five minutes under battery power, camera power automatically turns off (Auto Power Off).
- The screen saver displays protected images only. The screen saver is disabled if there are no protected images in memory.
- PC Link will not send images between the camera and a personal computer while the screen saver is turned on. Make sure you turn off the screen saver before trying to perform any image transfer operation. Note that the screen saver is turned on when you purchase the camera.

## To turn the screen saver on and off

1. Slide the Function Switch to PLAY.
2. Press MENU.



3. Use [+] and [-] to select SETUP, and then press the shutter button.



4. Use [+] and [-] to select SCREEN SAVER, and then press the shutter button.

5. Use [+] and [-] to select ON, and then press the shutter button.

- To turn off the screen saver, perform the above procedure and select OFF in step 5.
- The screen saver activates if you do not perform any operation for about five minutes in the Playback Mode.
- To stop an ongoing screen saver operation, press the shutter button.
- When changing between images, the screen saver uses the interval that is specified for Auto Play (page 78). To change the interval, press MENU while a screen saver operation is in progress, and then specify the interval time you want.

79

## EDITING IMAGES

A selection of powerful built-in editing tools helps you to create the effects you want.

### Adding a Title to an Image

Adding a title to an image is actually a two-step process. First you record the title into title memory, and then you superimpose the title onto the image. Because of this, you should prepare the title by printing it out on your computer or handwriting it on a sheet of paper.

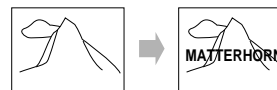

### Recording the Title

#### IMPORTANT!

- There is space for only one title in title memory. Any title already in memory is automatically deleted whenever you record a new title.
- The digital zoom feature cannot be used when recording a title.

1. Slide the Function Switch to REC.

2. Align the dial with  to select title recording.



3. After composing the title on the monitor screen, press the shutter button about half way and hold it there to activate Auto Focus.

- When recording a title, make sure the title is within the frame shown on the monitor screen.
- You can use [+] and [-] to adjust the exposure of the title image. See "Exposure compensation" on page 45 for details.

80

- After confirming that the Auto Focus operation is complete (operation indicator is green), press the shutter button all the way down to record the image.



- Use [+] and [-] to adjust the brightness of the title image (±30), and then press the shutter button.
  - The brightness adjustment you make here is stored along with the title image data.

### Superimposing a Title onto an Image

#### ▶▶ IMPORTANT! ◀◀

The TITLE icon is blue, indicating that the title operation is disabled in the following cases.

- When there is not enough remaining memory to store the result of the title operation.
- While a movie image or panorama image is on the monitor screen.
- When the "MEMORY FULL" or "FOLDER FULL" message is on the monitor screen in the REC Mode.

- Slide the Function Switch to PLAY.
- Use [+] and [-] to display the image onto which you want to superimpose the title.

- Press MENU.



- Use [+] and [-] to select EFFECT, and then press the shutter button.



- Use [+] and [-] to select TITLE, and then press the shutter button.



- Press MENU.

- Pressing the shutter button here, performs title superimpose using the last method you previously selected.



- Use [+] and [-] to select the color you want the title to be, and then press the shutter button.



- Each press of [+] or [-] scrolls through the selection of 20 available title colors.

- Use [+] and [-] to select the type of title plate you want to use, and then press the shutter button.



- Each press of [+] or [-] scrolls through the selection of 4 available title plate settings.

- Title plate settings consist of 4 plate variations, plus a setting that specifies no title plate.

- Use [+] and [-] to select the color you want the plate to be, and then press the shutter button.

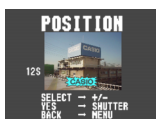

- Each press of [+] or [-] scrolls through the selection of 12 available plate colors.

- Use [+] and [-] to select the position of the title on the image, and then press the shutter button.

- Each press of [+] or [-] changes title locations.
- Note that pressing the shutter button does not change the existing image, but creates a new image with the superimposed title. The new image in inserted directly after the original (non-titled) image.

## USING FOLDERS

Folders help you to group your images into any arrangement you like. You can use folders, for example, to keep your personal images separate from images you need for business. There are six folders from which to choose. Any image you record is automatically placed into in the currently selected folder.

#### ▶▶ NOTE ◀◀

You cannot create additional folders.

#### Recording an Image in a Specific Folder

Images you record are normally stored in the CAMERA folder. See "Using the Record Menu" on page 59 for information about how you can change to another folder to store images.

- Up to 250 images can be stored in a single folder.

#### Selecting a Folder to Save Images

To select a folder using the FOLDER button

- Slide the Function Switch to PLAY.
- Each press of  sequentially selects available folders.

To select a folder using the MENU button

- Slide the Function Switch to PLAY.
- Press MENU.



- Use [+] and [-] to select TOOL, and then press the shutter button.

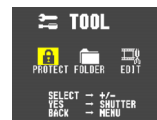

- Use [+] and [-] to select FOLDER, and then press the shutter button.

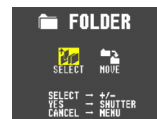

## USING FOLDERS

- Use [+] and [-] to select SELECT, and then press the shutter button.



- Use [+] and [-] to select the folder you want, and then press the shutter button.

### To Move a Single Image from One Folder to Another

#### IMPORTANT!

Make sure the folder that contains the image you want to move is currently selected before you start the following procedure.

- Slide the Function Switch to PLAY.
- Press MENU.



- Use [+] and [-] to select TOOL, and then press the shutter button.



85

## USING FOLDERS

- Use [+] and [-] to select FOLDER, and then press the shutter button.

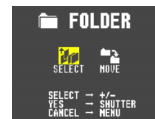

- Use [+] and [-] to select MOVE, and then press the shutter button.

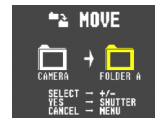

- Use [+] and [-] to select the folder to which you want to move the image, and then press the shutter button.

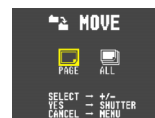

- Use [+] and [-] to select PAGE, and then press the shutter button.

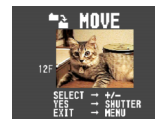

- Use [+] and [-] to select the image you want to move, and then press the shutter button.
- Repeat step 8 to move additional images into the selected folder.
- After you are finished moving images, press MENU to complete the operation.

86

## USING FOLDERS

### To Move All the Contents in One Folder to Another Folder

#### IMPORTANT!

Select the folder whose images you want to move before starting the following procedure.

- Slide the Function Switch to PLAY.
- Press MENU.



- Use [+] and [-] to select TOOL, and then press the shutter button.

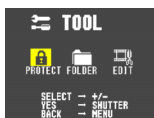

- Use [+] and [-] to select FOLDER, and then press the shutter button.

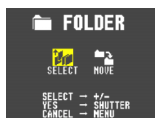

- Use [+] and [-] to select MOVE, and then press the shutter button.

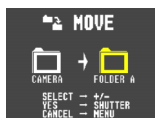

- Use [+] and [-] to select the folder to which you want to move the images, and then press the shutter button.

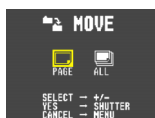

- Use [+] and [-] to select ALL, and then press the shutter button.

87

## IMAGE PROTECTION

Use the following operations when you want to protect images against accidental deletion. A protected image cannot be deleted until it is unprotected. You can protect and unprotect a single specific image, all the image in a particular folder, or all images currently on the memory card.

#### IMPORTANT!

Formatting a memory card (page 25) deletes all images on the card, even if some or all of the images are protected.

### To Protect and Unprotect a Single Image

- Slide the Function Switch to PLAY.
- Press MENU.



- Use [+] and [-] to select TOOL, and then press the shutter button.

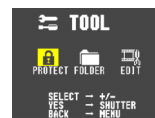

- Use [+] and [-] to select PROTECT, and then press the shutter button.

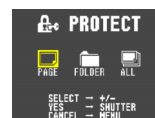

- Use [+] and [-] to select PAGE, and then press the shutter button.



- Use [+] and [-] to select the image you want to protect or unprotect.

88

**7. Press the shutter button to toggle image protection on and off.**

- The  indicator in the upper left corner of an image indicates that it is protected.

**8. If you want to protect or unprotect other images, repeat steps 6 and 7.**

- To exit the image protect operation, press MENU. The image protect operation is also cancelled automatically if you do not perform any button operation for about one minute.

**To Protect and Unprotect Folders**

**1. Slide the Function Switch to PLAY.**

**2. Press MENU.**



**3. Use [+] and [-] to select TOOL, and then press the shutter button.**

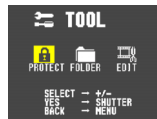

**4. Use [+] and [-] to select PROTECT, and then press the shutter button.**

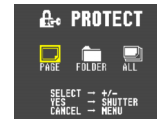

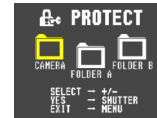

**5. Use [+] and [-] to select FOLDER, and then press the shutter button.**



**6. Use [+] and [-] to select the folder you want to protect or unprotect, and then press the shutter button.**

**7. Use [+] and [-] to select ALL (when protecting a folder) or CANCEL (when unprotecting a folder), and then press the shutter button.**

- A  indicator appears in the upper left corner of all the images of a protected folder (page 88).
- Unprotecting a folder removes the  indicators from its images (page 88).

**IMPORTANT!**

Formatting the camera's CompactFlash card deletes all images stored on it, regardless of whether the images are protected or not.

**To Protect and Unprotect All Images on the Memory Card**

**1. Slide the Function Switch to PLAY.**

**2. Press MENU.**



**3. Use [+] and [-] to select TOOL, and then press the shutter button.**

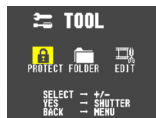

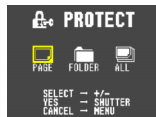

**4. Use [+] and [-] to select PROTECT, and then press the shutter button.**



**5. Use [+] and [-] to select ALL, and then press the shutter button.**

**6. Use [+] and [-] to select ALL (protect) or CANCEL (unprotect), and then press the shutter button.**

- The  indicator that is shown in the upper left corner of the images when image information is turned on (page 88) indicates they are protected.
- The  indicator does not appear when images are not protected.

**DELETING IMAGES**

Use the following operations when you want to delete images. You can delete a single specific image, all the images in a particular folder or all images currently on the memory card.

**IMPORTANT!**

- Image deletion cannot be undone. Before deleting an image, make sure you no longer need it or you have a back-up copy saved on you computer, on diskette, or on some other medium.
- Be especially careful with the DELETE ALL operation, which deletes all unprotected images in memory.
- A protected image cannot be deleted. See "Image Protection" on page 88 for details on protecting and unprotecting images.
- The delete icon is blue, indicating that the image delete operation is disabled, when all images are protected.

**To Delete a Single Image**

**1. Slide the Function Switch to PLAY.**

**2. Press MENU.**



**3. Use [+] and [-] to select DELETE, and then press the shutter button.**

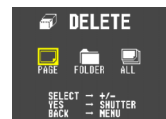

**4. Use [+] and [-] to select PAGE, and then press the shutter button.**



## DELETING IMAGES

### 5. Use [+] and [-] to select the image you want to delete.

- Protected images are not displayed.

### 6. Double check to make sure that you really want to delete the image you selected.

- To abort the delete operation without deleting anything, press any button besides [+], [-], or the shutter button.

### 7. To actually delete the selected image, press the shutter button.

- The selected image is deleted and the next image in sequence is selected.
- Movie and panorama images are deleted as groups.

### 8. If you want to delete more images, repeat steps 5 through 7.

- To exit the image delete operation, press any button besides [+], [-], or the shutter button.

### NOTE

The camera does not maintain open spaces in its memory. Deleting an images causes all images following the deleted image to be shifted up.

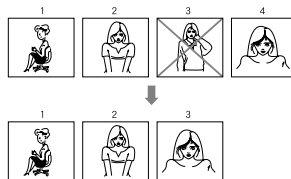

93

## DELETING IMAGES

### To Delete All the Images in a Folder

Protected images (page 88) are not deleted by this procedure.

#### 1. Slide the Function Switch to PLAY.

#### 2. Press MENU.



#### 3. Use [+] and [-] to select DELETE, and then press the shutter button.

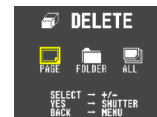

#### 4. Use [+] and [-] to select FOLDER, and then press the shutter button.

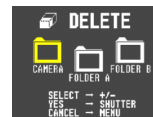

#### 5. Use [+] and [-] to select the folder whose contents you want to delete, and then press the shutter button.

#### 6. Use [+] and [-] to select ALL, and then press the shutter button.

94

## DELETING IMAGES

### To Delete All Unprotected Images

See "Image Protection" on page 88 for details on protecting and unprotecting images.

#### 1. Slide the Function Switch to PLAY.

#### 2. Press MENU.



#### 3. Use [+] and [-] to select DELETE, and then press the shutter button.

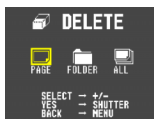

#### 4. Use [+] and [-] to select ALL, and then press the shutter button.

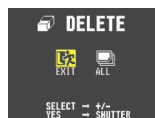

### IMPORTANT!

The next step deletes all unprotected images on the memory card. To abort this operation without deleting anything, select EXIT instead of ALL.

#### 5. Use [+] and [-] to select ALL, and then press the shutter button.

- If you perform the above operation when there are no protected images in memory, the message "NO IMAGE" appears on the monitor screen after the delete operation is complete.
- When the above procedure is performed while there are protected images in memory, the first of the protected images appears on the monitor screen after the unprotected images are deleted.

95

## CONNECTIONS

This camera is equipped with VIDEO OUT terminal for connection to a television or video deck, and a DIGITAL terminal for connection to a computer or other equipment.

### VIDEO OUT Terminal

#### • Television (page 98)



#### • Video Deck, Video Printer

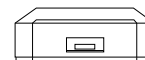

You can connect to a video tape deck and record image to tape. Or you can connect to a video printer to produce hard copy print-outs of your images.

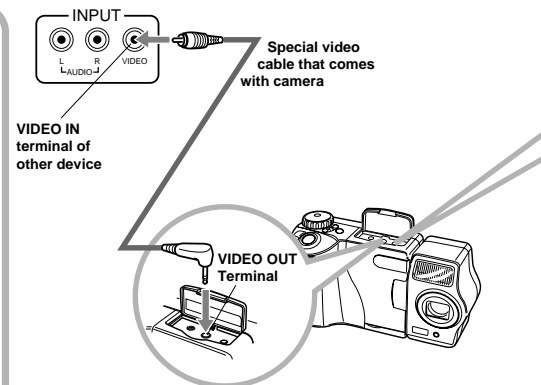

96



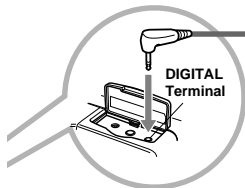

**Cables**

The type of cable you should use depends on the type of equipment to which you are connecting.

**IMPORTANT!**

- Be sure to turn off both the camera and other equipment before making any connections.
- Check the documentation that comes with your other equipment for information you may need to know when making connections.
- Leaving the same image displayed on a television or computer display screen for very long periods can cause the image to be "burned in" on the screen. When this happens, a faint after-image remains on the screen, even after you disconnect the camera. To avoid this, you should not leave the same image displayed on such a screen for very long periods.
- This camera does not support cable transfer of data with other CASIO digital cameras.

**DIGITAL Terminal**

- **Computer (page 101)**



- **QV Color Printer (page 100)**



**CONNECTING TO OTHER EQUIPMENT**

**To Connect to a Television**

You can playback images in camera memory on the screen of a connected television.

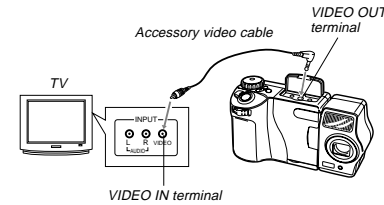

1. **Connect one end of the video cable to the camera and the other end to the television.**
2. **Set up the television for video input.**
  - See the documentation that comes with the television for information about how to do this.
3. **Use the operations under "Playback" on page 67 to playback images on the television screen.**

**IMPORTANT!**

- A television must have a video input terminal like the one shown in the illustration to connect to this camera.
- Battery capacity (page 29) and other displays that normally appear on the camera's monitor screen are also displayed on the television screen.
- The monitor screen goes blank as soon as you connect the video cable to the camera.

**Selecting the Video Output Signal Mode**

You can select either of two common video output modes: NTSC or PAL.

The video system you should use depends on the country where you plan to use the output signal. In the United States or Japan, for example, you should use NTSC, but in Europe you need to use PAL.

Check with your local video or TV retailer if you are unsure about which video mode you should use in your country.

CONNECTING TO OTHER EQUIPMENT

**To Change the Video Output Mode**

1. Slide the Function Switch to **PLAY**.
2. Press **MENU**.



3. Use **[+]** and **[-]** to select **SETUP**, and then press the shutter button.



4. Use **[+]** and **[-]** to select **VIDEO OUT**, and then press the shutter button.



5. Use **[+]** and **[-]** to select the video mode you want to use, and then press the shutter button.

CONNECTING TO OTHER EQUIPMENT

**To Connect to a QV Color Printer**

You can use a QV Color Printer to produce printouts of your image data.

Supported Printer Models: DP-300, DP-8000

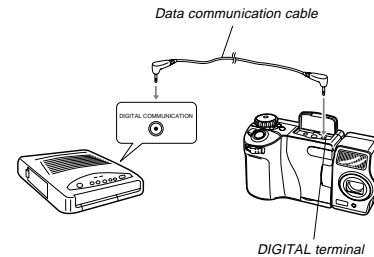

1. **Connect one end of the cable that comes with the QV Color Printer to the camera and the other end to the printer.**

2. **Slide the camera's Function Switch to PLAY and then turn on camera power.**

3. **Perform the QV Color Printer operations required for printing.**

- See the documentation that comes with the QV Color Printer for details.
- Performing a print operation for a movie prints the 4 or 16 individual frames that make up the movie.
- Printing a panorama prints the individual images that make up the panorama.

## Connecting to a Personal Computer

## PC Link Software

Special PC Link software available from CASIO makes image data transfers with a personal computer quick and easy. The software is also designed to minimize loss of image quality due to data transfer. For details on how to connect to a personal computer and exchange data, see the documentation that comes with the PC Link software.

LK-12S for Windows  
LK-22S for Windows and Macintosh

## »» IMPORTANT! ««

- This camera does not fully support the software that comes with the LK-1, LK-1A, LK-10V, LK-11 connection kits for Windows, and the LK-2, LK-2A, LK-2V, LK-21 connection kits for the Macintosh. Never try to use the software that comes with these connections kits with this camera.
- When you download files from your computer to the camera (using the Send To Camera or Send Files pull-down menu command), the following message appears on your computer screen: "are converted to the CAM format". This message does not apply to images downloaded to the QV-7000SX, and images are transferred in JPEG format.

101

## INFRARED DATA TRANSFER

IrTran-P

This camera can perform IrDA data communication with digital equipment that supports IrTran-P protocol. Infrared data transfer capabilities let you exchange image data with another digital camera without physical connection.

- This camera uses IrDA IrTran-P protocol, which was jointly developed by NTT, Sony, Sharp, Okaya Systemware and CASIO to provide a means for transferring digital camera still images using infrared signals. (January 1998)

## »» IMPORTANT! ««

- IrTran-P communication can be performed only with equipment that supports IrTran-P protocol.
- During IrTran-P image data transfers, the ID (product identification string) of the other equipment is shown on the camera's monitor screen. The ID normally shows the manufacturer and product name, but no ID may appear at all, depending on how the equipment was set up by the manufacturer.
- When performing IrTran-P data communication with another QV-7000SX camera, images are transferred as-is, without any change in size (1280 x 960 or 640 x 480 pixels).
- When using IrTran-P data communication to send image data to a CASIO QV-770 digital camera, QV-7000SX 1280 x 960 images are converted to 640 x 480 images.
- How images are affected by IrTran-P transfers with other equipment depends on the other equipment.

102

## Receiving Data

## To Setup to Receive

## ▶▶▶ BUTTON OPERATION

## 1. Slide the Function Switch to PLAY.

2. Press .

- This causes the receive standby screen to appear.



## 3. Align the infrared port of the camera with the port of the sending unit, and start the send operation.

- See the documentation that comes with the sending unit for details on its operation.

## INFRARED DATA TRANSFER

## MENU BUTTON OPERATION

## 1. Slide the Function Switch to PLAY.

## 2. Press MENU.



## 3. Use [+] and [-] to select IR, and then press the shutter button.

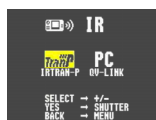

## 4. Use [+] and [-] to select IRTRAN-P, and then press the shutter button.

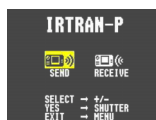

## 5. Use [+] and [-] to select RECEIVE, and then press the shutter button.

- This causes the receive standby screen to appear.



## 6. Align the infrared port of the camera with the port of the sending unit, and start the send operation.

- See the documentation that comes with the sending unit for details on its operation.

103

## INFRARED DATA TRANSFER

## Sending Data

Transferring a movie or panorama to another model QV Digital Camera (other than the QV-7000SX) causes the images to be ungrouped. Such images cannot be played back on other CASIO QV Digital Camera Models.

You can send a single specific image, all the images in a particular folder or all images currently on the memory card.

## To Send a Single Image

## ▶▶▶ BUTTON OPERATION

## 1. Slide the Function Switch to PLAY.

## 2. Use [+] and [-] to select the image you want to send.

3. Press .

- This causes the send standby screen to appear.

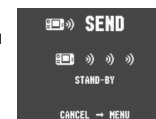

## 4. Align the infrared port of the receiving device that supports IrTran-P protocol.

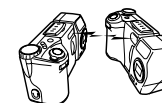

- Position the cameras so they are 10cm to 30cm (3.9" to 11.8") apart from each other.
- To cancel an image data send operation, press MENU.

104

INFRARED DATA TRANSFER

MENU BUTTON OPERATION

1. Slide the Function Switch to PLAY.

2. Press MENU.



3. Use [+] and [-] to select IR, and then press the shutter button.



4. Use [+] and [-] to select IRTRAN-P, and then press the shutter button.

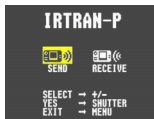

5. Use [+] and [-] to select SEND, and then press the shutter button.

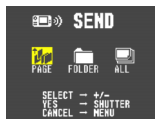

6. Use [+] and [-] to select PAGE, and then press the shutter button.

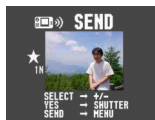

7. Use [+] and [-] to display the image you want to send, and then press the shutter button.

- Images selected for the send operation are indicated by ★.
- Repeat step 7 if you want to send more than one image.
- Some devices do not support transfer of multiple images, even though they do support IrTran-P protocol.

INFRARED DATA TRANSFER

8. Press MENU.

- This causes the send standby screen to appear.

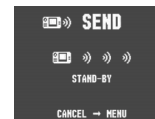

9. Align the infrared port of the receiving device that supports IrTran-P protocol.

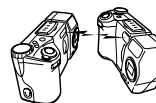

- Position the cameras so they are 10cm to 30cm (3.9" to 11.8") apart from each other.
- To cancel an image data send operation, press MENU.

To Send the Contents of an Entire Folder

1. Slide the Function Switch to PLAY.

2. Press MENU.



3. Use [+] and [-] to select IR, and then press the shutter button.

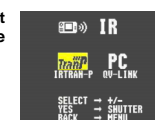

4. Use [+] and [-] to select IRTRAN-P, and then press the shutter button.



INFRARED DATA TRANSFER

5. Use [+] and [-] to select SEND, and then press the shutter button.

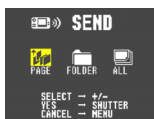

6. Use [+] and [-] to select FOLDER, and then press the shutter button.



7. Use [+] and [-] to select the destination, and then press the shutter button.

- This causes the send standby screen to appear.
- Position the cameras so they are 10cm to 30cm (3.9" to 11.8") apart from each other.
- Some camera models may not be able to receive multiple images.
- All images may not be able to be sent if the receiving camera does not have enough memory.
- To cancel an image data send operation, press MENU.

To Send All Images

1. Slide the Function Switch to PLAY.

2. Press MENU.



INFRARED DATA TRANSFER

3. Use [+] and [-] to select IR, and then press the shutter button.

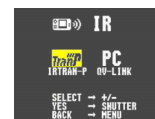

4. Use [+] and [-] to select IRTRAN-P, and then press the shutter button.



5. Use [+] and [-] to select SEND, and then press the shutter button.

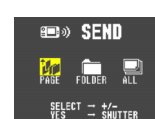

6. Use [+] and [-] to select ALL, and then press the shutter button.

- This causes the send standby screen to appear.

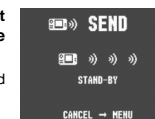

7. Align the infrared ports.

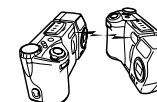

- Position the cameras so they are 10cm to 30cm (3.9" to 11.8") apart from each other.
- To cancel an image data send operation, press MENU.

**Transferring Images Using PC Link Software**

With PC Link Software, cable-free infrared image data transfer can be performed with a personal computer that supports IrDA1.0 protocol or later. See the documentation that comes with your computer for details on its infrared communication capabilities.

Movie images that are uploaded to a personal computer and then download back to the camera cannot be played back as a movie. Uploading a movie image to a computer ungroups it, so you will not be able to play it back when you download it back to the camera unless you re-group them using the procedure on page 69.

1. Slide the Function Switch to PLAY.
2. Press MENU.



3. Use [+] and [-] to select IR, and then press the shutter button.



4. Use [+] and [-] to select QV-LINK, and then press the shutter button.



5. Align the infrared port of the camera with the port of your computer.
6. Start up the PC Link software on your computer and transfer the images you want.

**Infrared Data Transfer Precautions**

- Make sure that the infrared ports of the sending unit and the receiving unit are pointed straight at each other, and that there is nothing blocking the path between them.
- To avoid problems that occur due to sudden loss of battery power during infrared image transfer, we recommend that you use the separately AC adaptor specified for this camera when transferring images.
- Avoid performing infrared data transfers in areas expose to direct sunlight or other strong illumination.
- Such conditions as natural outdoor light, low battery power, too much distance between infrared ports, and misalignment of infrared ports can cause failure of image transfers or corrupted data.
- Proper image data transfer is impossible whenever there is anything blocking either of the infrared ports.
- Do not locate any other infrared emitting device (such as remote control units) or fluorescent lighting in the vicinity of the cameras while they are performing infrared image transfers.
- Failure to be able to establish an IrDA connection can mean that the device you are trying to communication with does not support the IrDA standard, or that the applications being used are not compatible. When this happens, you probably have to connect the camera to the computer with a separately available cable for data transfer.

**USING CompactFlash CARDS WITH YOUR COMPUTER**

**Setting Up to Access CompactFlash Card Contents From Your Computer**

You can use any of the three methods described below to access the contents of a memory card with your computer. If you use your computer to change the fixed names of the folders created by this camera, the camera will no longer display the renamed folders.

**CompactFlash Memory Card Slot**

If your computer has a CompactFlash Memory Card Slot, insert the camera's memory card into the slot.

**PC Card Slot**

In this case you need an optionally available CASIO CA-10 PC Card Adaptor. See the instructions that come with the PC Card Adaptor and the documentation that comes with your computer for details on using this type of configuration.

**Other Desktop Computer Configurations**

Some desktop computers require a separately available PC card reader/writer and the optionally available CASIO CA-10 PC Card Adaptor to read memory card contents. See the instructions that come with the PC card reader/writer and the PC Card Adaptor for details on using this type of configuration.



**CompactFlash Card Precautions**

**CompactFlash Card Directory Tree**

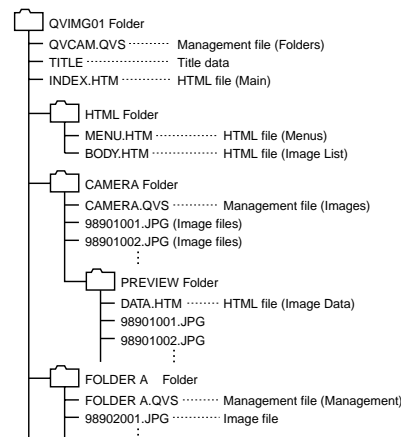

- Management File (Folders)/(Images)  
These files contain data about folder management and image sequence.
- Title Data  
This is data recorded when a title is recorded. It is used when adding titles to images.
- HTML Files (Main)/(Menus)/(Image List)/(Image Data)  
These files are for displaying lists of images in camera memory using a Web browser.
- CAMERA Folders  
These folders are for storing image data. There are six CAMERA folders: CAMERA, FOLDER A, FOLDER B, FOLDER C, FOLDER D, FOLDER E.
- Image Files  
These JPEG files are images recorded by the camera. See page 26 for details on how file names are generated.
- PREVIEW Folder  
This folder is for storing preview images.
- Preview Image File  
A preview image JPEG file is created whenever an image is recorded. Preview images are used when scrolling through images on the camera's monitor screen and in the HTML image lists displayed on your computer's screen.

### Image Files Supported by the Camera

- Image files recorded with the CASIO QV-7000SX Digital Camera
- JPEG files stored using QV-LINK 2.6 for Windows (1280 x 960 pixels or 640 x 480 pixels JPEG file)
- JPEG files stored using QV-CRAFT (1280 x 960 pixels or 640 x 480 pixels JPEG file)

### CompactFlash Card Precautions

#### Personal Computer

- This camera uses management files to manage the sequence and attributes of image files. Because of this, adding files, deleting files, changing management file contents, or changing file sequence and attributes with your computer can cause movie and panorama images to become ungrouped. It can also result in slower image scrolling on the camera.
- When transferring CompactFlash card contents to a hard disk, floppy diskette, MO disk, or other external storage, keep everything in the QVIMG01 folder together. Changing the name of the QVIMG01 folder to a date is a good way to keep track of your images. However, be sure to change the name of this folder back to QVIMG01 if you ever copy it back to the memory card for playback on the camera. This camera does not recognize any folder name besides QVIMG01.
- The above is also true about the names of folders inside the QVIMG01 folder. These folders must be returned to the names assigned to them by the camera (CAMERA, FOLDER A, etc.) whenever you copy the QVIMG01 folder back to the memory card for playback on the camera.

- Never delete or modify the QVS file in any way.
- We also strongly recommend that after transferring data from a CompactFlash card to other external storage that you re-format the card and delete its contents before using it to record more images.

#### Macintosh Precautions

- Initializing a CompactFlash card with this camera initializes it to ATA format. Under ATA format, Apple Macintosh computers recognize files on the card as text files. Use PC EXCHANGE to associate the files on the card with QV-LINK or some other application that can open JPEG files.

### HTML File Generator

An HTML file is a file format for creating Internet Web pages. This camera can generate an HTML format file that allows you to display lists of recorded images as well as detailed information about each image.

- The HTML file generated by this camera is best viewed using Microsoft Internet Explorer 3.0 or later, or Netscape Navigator 2.0 or later. It cannot be viewed using QV-LINK.

#### 1. Slide the Function Switch to PLAY.

#### 2. Press MENU.



3. Use [+ ] and [- ] to select **SETUP**, and then press the shutter button.



4. Use [+ ] and [- ] to select **HTML**, and then press the shutter button.

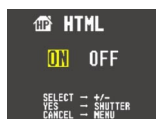

5. Use [+ ] and [- ] to select **ON**, and then press the shutter button.

- Turning on HTML file generation causes an HTML file to be generated whenever you turn off camera power.
- Selecting "OFF" in step 5 of the above procedure turns off HTML file generation.
- Creation of an HTML file causes an INDEX.HTM file and other files to be added to the QVIMG01 folder.

#### IMPORTANT!

- Low battery power and insufficient remaining memory capacity on the CompactFlash card can make it impossible to correctly generate an HTML file.
- When you turn off camera power, the operation indicator lights to indicate that HTML files are being generated by the camera. If you remove the camera's batteries or disconnect the AC adaptor while the operation indicator is lit after turning off power, no HTML files are generated.
- If the CompactFlash card in the camera has a large number of files on it, it may take quite a bit of time for the camera to generate the required HTML files and actually turn off after you slide the power switch towards OFF. Because of this, we recommend that you normally leave HTML file generation turned off, except when you actually want to generate HTML files.
- If you perform a timer operation while HTML file generation is turned on, HTML files are not generated until the number of shots specified for the timer's SHOTS setting are recorded. If you want to generate HTML files for images recorded by a timer operation that is not yet complete, turn the camera off, wait for the HTML files to be generated, and then turn the camera back on again. Note, however, that this also cancels the ongoing timer operation.

### How to use the HTML file

#### Viewing HTML File Contents

Load the CompactFlash card into a card slot of your computer (page 111). Now drop the INDEX.HTM file (in the QVIMG01 folder) onto your Web browser to display a list of all images contained on the CompactFlash card.

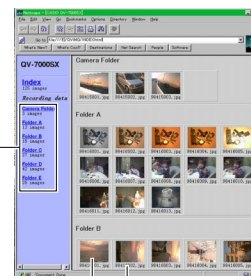

Clicking on a folder name displays the following data about the images contained in the folder.



#### Image Information

- File size (KB)
- Resolution (pixels)
- Quality
- Recording mode
- AE
- Light metering
- Shutter speed
- Aperture stop
- Exposure comp
- Focusing mode
- Flash mode
- White balance
- Digital zoom
- Date

Click Index to return to the image list.

**Saving an HTML File**

- When transferring CompactFlash card contents to a hard disk, floppy diskette, MO disk, or other external storage, keep everything in the QVIMG01 folder together. Changing the name of the QVIMG01 folder to a date is a good way to keep track of your images. However, note that you should never delete or modify the QVS file in any way.
- Before using the CompactFlash card again (after storing its images on other media), delete all its current files or reformat the card.

**TROUBLESHOOTING**

	Symptom	Probable Cause	Action
Power Supply	No power	1. Batteries not loaded correctly. 2. Dead batteries 3. Wrong AC adaptor	1. Correctly load batteries (page 27). 2. Replace all four batteries with a set of new ones (page 27). 3. Use only recommended AC adaptor .
	Sudden power failure	1. Auto Power Off 2. Low battery power 3. Use of manganese batteries.	1. Turn power back on. 2. Replace all four batteries with a set of new ones (page 27). 3. Replace manganese batteries with alkaline, lithium or Ni-MH batteries.
	 indicator on LCD	Batteries are about to go dead.	Replace all four batteries with a set of new ones (page 27).
Recording	No recording when shutter button is pressed	1. Function Switch set to PLAY. 2. Flash unit is charging. 3. The message "MEMORY FULL" is on the monitor screen. 4. The message "REMAINING" is on the monitor screen. 5. Insufficient memory card capacity or no memory card loaded in camera.	1. Set Function Switch to REC. 2. Wait until flash unit charging is finished. 3. Delete images you no longer need from camera memory. 4. Change to another resolution mode, or delete images you no longer need from camera memory. 5. Load a memory card.

**TROUBLESHOOTING**

	Symptom	Probable Cause	Action
Recording	Auto Focus cannot focus the image.	1. Lens or distance sensor is dirty. 2. The object you want to focus is not in the focus frame. 3. Conditions make it impossible to obtain proper focus.	1. Clean off the lens or distance sensor. 2. Aim the camera so the object you want to focus is in inside the focus frame. 3. Switch to the Manual Mode and focus manually.
	Power failure during self-timer operation	Low battery power	Replace all four batteries with a set of new ones (page 27).
	Monitor screen image is out of focus.	1. Failure to focus the image while the camera is in the Manual Mode. 2. Camera is in the Macro Mode. 3. Camera is in the Normal Mode while the subject is too close.	1. Focus the image before recording it. 2. Use the Normal Mode for scenery and group shots. 3. Use the Macro Mode for close ups.
	Poor color and brightness when indoors	Indoor fluorescent lighting	Shoot under incandescent or other non-fluorescent lighting (page 39).
	Part of the image is missing.	Blocking of the lens when recording.	Hold the camera correctly, making sure that your finger or the wrist strap is not blocking the lens.
	Cannot perform movie recording.	1. Movie Record Mode is not selected. 2. Insufficient camera memory capacity.	1. Select the Movie Record Mode (page 50). 2. Delete images you no longer need from camera memory, so there are at least two <b>S</b> (SUPER FINE) images worth of free memory capacity.

**TROUBLESHOOTING**

	Symptom	Probable Cause	Action
Playback	Color of recorded image is strange.	Reflection from sunlight or light from another source	Reorient the camera so that light is not shining directly into lens.
	No +/- button operation during multi-page display	Button operation during page change	Wait until an image is on the monitor screen before performing a button operation.
	Some images are missing.	No images in selected folder	Check other folders for images.
	Cannot use multi-page display.	No images in selected folder	Check other folders for images.
	Camera is connected to a TV, but LCD monitor contents do not appear on TV screen.	1. Incorrect camera-TV connection 2. Wrong TV set up 3. Wrong video mode is selected.	1. Connect correctly using the video cable (page 98). 2. Set up the TV correctly. 3. Change the video mode.
Deletion	Images cannot be displayed when downloaded back the camera from a computer.	The images were on a memory card when they were opened on the computer for editing and then resaved back to the memory card.	Use the QV-LINK application to download edited images back to the camera.
	Delete operation does not operate.	All pages are protected.	Unprotect the page you want to delete (page 88).
	Other	Menu icon is blue and nothing happens when it is selected.	• Certain functions are disabled in some modes. A disabled function is indicated by a blue icon. • No image

## TROUBLESHOOTING

	Symptom	Probable Cause	Action
Other	All buttons and switches do not operate.	<ul style="list-style-type: none"> <li>Malfunction due to static electrical charge or strong impact.</li> <li>Camera is connected to a computer or QV Color Printer.</li> </ul>	Remove batteries and disconnect the AC adaptor if you are using one. Restore power and turn the camera on. If this does not work, contact your dealer or an authorized CASIO service provider.
	Cannot perform infrared data communication.	<ol style="list-style-type: none"> <li>Other device does not support IrTran-P protocol.</li> <li>Sending and receiving units are not positioned correctly.</li> <li>Object blocking the infrared light path, another device using infrared light is in the vicinity, or fluorescent lighting.</li> <li>Direct sunlight</li> </ol>	<ol style="list-style-type: none"> <li>Communicate only with devices that support IrTran-P protocol.</li> <li>Orient the infrared ports of the two devices so they are pointed directly at each other (pages 104, 106, 108).</li> <li>Move the sending and receiving devices away from the source of the problem.</li> <li>Avoid infrared data communication in direct sunlight.</li> </ol>
	Auto Play starts even though it is not selected.	Activation of the screen saver.	Turn off screen saver (page 78).

121

## MESSAGES

<b>CANT PLAY PANORAMA</b>	Not enough memory available for panorama playback. Delete some images you no longer need and try again.
<b>CF CF ERROR FORMAT → MENU</b>	Perform the following procedure whenever a memory card starts to behave abnormally.  <b>Important!</b> The procedure described below deletes all images stored in the memory card. Make sure all of your important images are backed up onto a computer hard disk or other storage medium before performing this procedure.  <b>To reformat a memory card</b> <ol style="list-style-type: none"> <li>Connect the AC adaptor to the camera and switch to AC power or load a new set of batteries into the camera. <ul style="list-style-type: none"> <li>Power failure while a format operation is being performed aborts the reformat operation.</li> </ul> </li> <li>Press MENU.</li> <li>Use [+ ] and [- ] to select FORMAT, and then press the shutter button.</li> </ol> <ul style="list-style-type: none"> <li>Select EXIT if you want to abort the reformat procedure without deleting anything.</li> </ul>



- Press the shutter button to start the memory card format operation.
  - To interrupt a format operation part way through, turn off camera power.
  - Completion of the format operation is indicated by the message "NO IMAGE" appearing on the monitor screen. This message also indicates that the memory card was formatted successfully.

<b>CF NO CARD</b>	There is no memory card installed in the camera.
<b>DECODE ERROR</b>	The JPEG image file you are trying to display is either corrupted or is a format that is not compatible with this camera.
<b>DIAL</b>	Incorrect dial setting
<b>ERROR</b>	Error during data communication. Check cable connections and mode settings.
<b>FOLDER FULL</b>	The folder you are trying to use is full. Delete some images you no longer need.
<b>FULL</b>	Indicates that movie recording is not possible because memory card is full. Delete images you no longer need in camera memory. Folder is full. Note that each folder can contain up to 250 images.

122

## MESSAGES

<b>MEMORY FULL</b>	<ul style="list-style-type: none"> <li>Not enough memory for further recording. Delete some images from memory card (page 92).</li> <li>QVIMG folder or other file (page 112) cannot be created due to insufficient memory when downloading data from a computer to the memory card. Use your computer to delete unneeded images to free up memory card space for the images you are downloading. You could also press the MENU button and format the memory card in the camera, but doing so deletes all image files currently stored on the memory card.</li> </ul>
<b>MEMORY OVER</b>	Data being received during infrared data transfer caused camera memory to become full. Delete some images you no longer need.
<b>NO IMAGE</b>	No images are stored in memory card.
<b>RECORD ERROR</b>	This message appears when the image you are trying to record cannot be compressed for some reason. Try changing the angle of the camera to the subject.
<b>REMAINING</b>	Not enough memory for recording in the current resolution mode. Change to another resolution mode, or delete some images from the memory card (pages 44, 92).
<b>SAME FILENAME ALREADY EXISTS</b>	The folder to which you are trying to move an image file already contains another image file with the same name. Change to another folder and try again.
<b>SYSTEM ERROR CALL TECH SUPPORT</b>	Problem with internal memory. Contact your dealer or an authorized CASIO service provider.

123

## SPECIFICATIONS

<b>Image File Record Format</b>	JPEG (with COMPACTFLASH memory card)
<b>Recording Medium</b>	COMPACTFLASH memory card
<b>Recorded Image Resolution</b>	1280 x 960 pixels / 640 x 480 pixels
<b>Memory Capacity/File Size</b>	S (1280 x 960): ..... 88/14 minimum (500 KB per image) F (1280 x 960): ..... 123/19 minimum (350 KB per image) N (1280 x 960): ..... 206/33 minimum (200 KB per image) E (640 x 480): ..... 340/55 minimum (112 KB per image) Movie (3.2 seconds): ..... 85/13 groups minimum (5 frames per second, 1 image = 4 frames x 4) Movie (6.4 seconds): ..... 85/13 groups minimum (10 frames per second, 1 image = 16 frames x 4) Movie (12.8 seconds): ..... 85/13 groups minimum (5 frames per second, 1 image = 16 frames x 4)
The above figures are approximations only. The actual number of images depends on image subject matter. Values such as 85/13 indicate the number of images that can be stored on a 48MB/8MB CompactFlash card.	
<b>Image Deletion</b>	Single image; all images in a folder; all images in memory card (with image protection)
<b>Imaging Element</b>	1/3-inch square pixel color CCD (Total Pixels: 1,320,000; Effective Pixels: 1,250,000)
<b>Lens</b>	F2.8 to 3.5. f = 5.0 to 10.0mm (equivalent to 32 to 64mm on a 35mm camera)
<b>Zoom</b>	2X optical zoom, 8X digital zoom (when used in combination with optical zoom)*

<b>Focusing</b>	Phase-difference detection system auto focus, manual focus; with macro mode and focus lock
<b>Focus Range</b>	(from surface of lens protection filter) 0.25m (0.8') to ∞ (standard)/10cm (4") (macro) (10cm to ∞ (4" to ∞) with manual focus) The above figures are approximations only.
<b>Exposure</b>	Light Metering: Multi-pattern/spot metering by CCD Exposure: Program AE, aperture priority AE Exposure Compensation: -2EV to +2EV (1/4EV units)
<b>Shutter</b>	CCD shutter, mechanical shutter
<b>Shutter Speed</b>	1/4 to 1/1000 second (1 second in Night Mode)
<b>Aperture</b>	F2.8 to F14 automatic and manual switching
<b>White Balance</b>	Automatic, fixed (4 modes), manual switching
<b>Self-timer</b>	10 seconds, 2 seconds
<b>Flash Modes</b>	AUTO, ON, OFF, Red-eye reduction
<b>Flash Range</b>	Approximately 0.7 to 2 meters (2.3' to 6.6')
<b>Recording Functions</b>	Single image; self-timer; movie; panorama; timer; title; macro; monochrome; sepia; Sports Mode; Night Mode

124

## SPECIFICATIONS

- Monitor/Viewfinder** ..... 2.5-inch TFT, low-glare color HAST LCD (122,100 pixels)
- Clock** ..... Built-in quartz digital clock; date and time recorded with image; auto calendar up to 2049
- Input/Output Terminals** .... DIGITAL OUT, VIDEO OUT (NTSC and PAL), AC adaptor connector
- Infrared Communication** .. IrDA1.1 (maximum 1.152Mbps); IrTran-P compliant
- Power Supply** ..... Four batteries (AA-size alkaline or lithium batteries)  
Four rechargeable batteries (AA-size Ni-MH batteries (NP-H3))  
AC adaptor (AD-C620)

The battery life reference values given below indicate the amount of time at standard temperature (25°C) until power automatically turns off due to battery failure. They do not guarantee that batteries will perform the amount of service indicated. Battery life is reduced by low temperatures and continued use.

Type of Operation	AA-size Alkaline Batteries LR6	AA-size Lithium Batteries FR6
Continuous Playback	80 minutes	190 minutes
Continuous Recording	210 shots	590 shots

- The above figures are approximations only.
  - The above guidelines are based on the following battery types:  
Alkaline: MX1500 (AA) DURACELL ULTRA  
Lithium: Fuji Film
  - Battery life varies with brand.
  - Figures are based on continuous recording under the following conditions.  
Flash turned off  
One zoom slider switching between T (Telephoto) and W (Wide-angle)
- Regardless of use of the camera's flash, zoom function, turning on and off the POWER Switch, as well as other operating conditions may affect the above values.

- Power Consumption** ..... Approximately 7.2 W
- Dimensions** ..... 140.5 (W) x 75 (H) x 52.5 (D) mm  
(5.5" (W) x 3" (H) x 2.1" (D))
- Weight** ..... Approximately 280g (9.9 oz) (excluding batteries)
- Standard Accessories** ..... 2-way shoulder/wrist strap; soft case; video cable; Owner's manual
- \* Image size with digital zoom is 640 x 480 pixels.  
\* The camera also has a lithium battery that powers its built-in clock. When the power of this battery becomes weak, take the camera to your CASIO Service Provider to have it replaced.  
\* The liquid crystal panel built into this camera is the product of precision engineering, with an effective pixel rate of 99.99%. This also means, however that 0.01% of the pixels can be expected to fail to light or to remain lit at all times.

# CASIO®

**CASIO COMPUTER CO.,LTD.**  
6-2, Hon-machi 1-chome  
Shibuya-ku, Tokyo 151-8543, Japan

MA9809-002501A Printed in Japan