



900 MHz CORDLESS CALLER ID TELEPHONE WITH CALL WAITING

40 CHANNEL AUTOSCAN

Model MH9915

OWNER'S MANUAL INSTALLATION AND OPERATING INSTRUCTIONS

***PLEASE READ THIS
MANUAL CAREFULLY
BEFORE USE.
KEEP FOR YOUR
REFERENCE.***

***For installation information, please
see "Getting Started" instructions
on page 5 or your separate
Quick Start guide.***

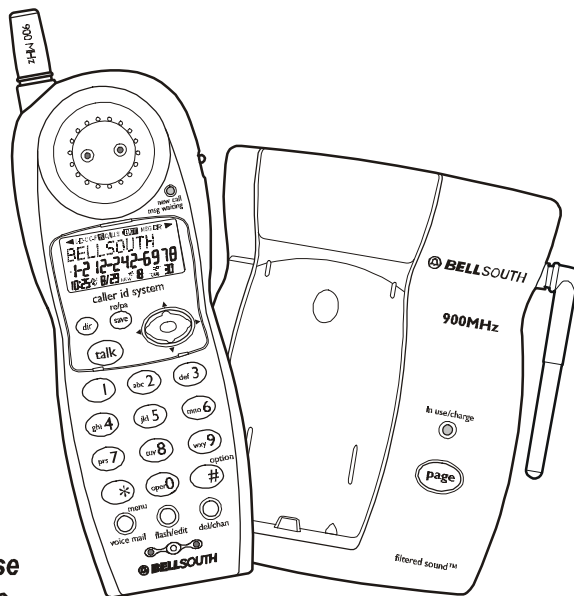

Visit Us on the Web
www.uselectronics.info

© 19952002 BellSouth Corporation

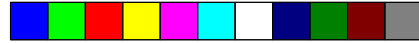

Special Features

Congratulations on your selection of a quality **BellSouth Product**. With proper care, and by following the setup and user instructions in this manual, this unit will provide you with years of trouble-free service.

BellSouth is committed to providing quality products that fit your needs. We would like to have any comments or suggestions you might have on this product. You may mail your comments to:

**U.S. Electronics
105 Madison Avenue
New York, NY 10016**

When examining your new **BellSouth** cordless telephone, you will find an array of special features including:

Filtered Sound™ System - Receives considerably less noise than conventional cordless telephones because of a special circuit which delivers the clearest possible reception.

50 Channel Autoscan - Press the  button on the **HANDSET** to find and lock on to the clearest channel for any call.

Desk or Wall Mount - Use this equipment as a desk phone or as a wall phone.

TONE or PULSE Dialing - Use this phone for either TONE (push-button) or PULSE (rotary) dialing.

Automated Functions - Redial the last number called and automatic STANDBY mode.

Security - Ensures greater privacy because a built-in security code with 65,536 combinations prevents use of your telephone line by another nearby cordless telephone.

Dependable Battery - Recharge your BATTERY PACK many times with the built-in charger. The battery low warning tone tells you when the BATTERY PACK needs recharging (See page 27).

Special Services - Use the  button to access special services such as Call Waiting supplied by your telephone company or company switchboard.

STANDBY Mode - When in STANDBY mode (ON-HOOK), the telephone is capable of receiving a call. When the **HANDSET** is on the **BASE UNIT**, it is automatically in the STANDBY mode (ON-HOOK). When the **HANDSET** is taken off the **BASE UNIT**, it remains in the STANDBY mode until you activate the  button.

Battery Power Saver - Once fully charged, in STANDBY mode, the **HANDSET** can receive/send calls for a maximum of five days without the need for recharging. Length of charge depends on frequency of use.

Luminous LCD Screen - The LCD Screen emits light for 10 seconds every time you press any of the TELEPHONE KEYPAD buttons.

HANDSET Ringer Level - Select the ringer sound level (HI, LOW, OFF).

HANDSET Volume Control Switch - Select the receiver volume level (HI, MID, LOW).

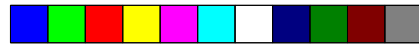

Special Features

HEADSET JACK - Your telephone can utilize a headset for hands-free communication.

BELT CLIP - Use the BELT CLIP to hang your **HANDSET** on your belt.

CALLER ID SYSTEM

Multi-Function Large LCD Screen - Shows the number you are dialing and, with Caller ID service (available through subscription from your local telephone company), displays information about the caller before you answer the call.

Name and Number DIRECTORY (PHONEBOOK) - Stores up to 40 names and numbers so that you can call them with a single key stroke.

Caller List - Available with Caller ID service. Stores up to 80 calls to keep track of everyone who called. The name, phone number, time and date of the call are recorded. Allows you to return their calls with a single key stroke.

Preferred Calls - You can mark the name and number of a welcome caller in the DIRECTORY (PHONEBOOK). When that number calls in, the caller's name will appear on the LCD Screen and a special ring sound will be heard.

Blocked Calls - You can mark the name and number of an unwelcome caller in the DIRECTORY (PHONEBOOK). When that number calls in, the caller's name will appear on the LCD Screen and the ringer will be disabled.

Repeat Call Indicator - Shows if a new incoming call has called more than once.

Unavailable Call Indicator - Advises you that the origin of the incoming call does not support the Caller ID system.

Call Waiting Service - Displays the name and number of the second caller, if you have subscribed for Call Waiting service from your local telephone company (see page 13).

Voice Mail - Indicates message waiting signal if you subscribed to Voice Mail message service and requested Visual Message Indication from your local telephone company (see page 13)

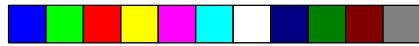

HANDSET Controls

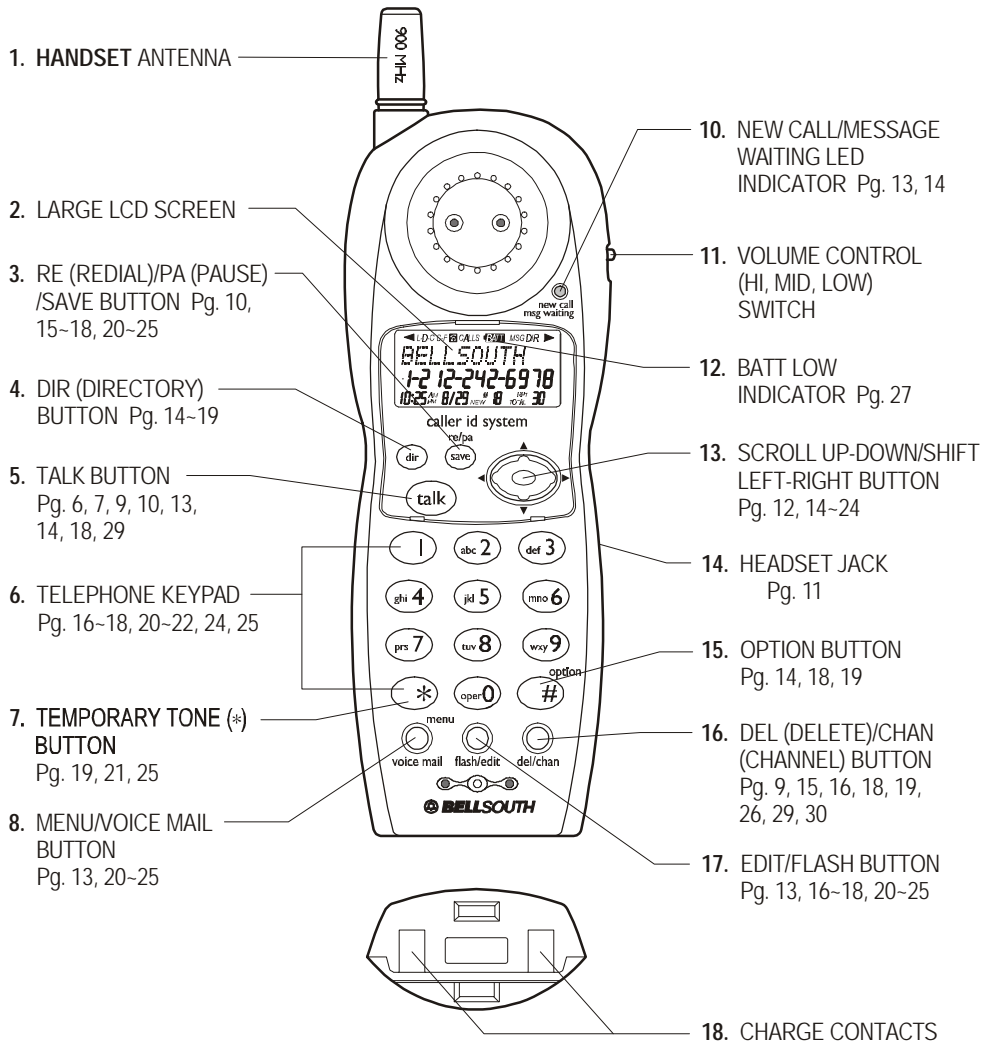

HANDSET Controls

1. HANDSET ANTENNA

2. **Large LCD Screen:** Shows call information, phone status, prompts, and directory items.



HANDSET Controls

3. **(save)/re (REDIAL)/pa (PAUSE) Button:** (SAVE) Press and hold down to save the changes on the listed items. (REDIAL) Press to redial the last number you dialed. (PAUSE) Press to insert a pause while dialing. (You will need the (save)/re/pa button to dial numbers which use an alternative Long Distance Access Code.)
4. **(dir) DIRECTORY (PHONEBOOK) Button:** Press to access names and numbers stored in the DIRECTORY (PHONEBOOK). (See pages 14 to 19 for details.)
5. **(talk) Button:** Press to answer an incoming call or to place a call. Press to end a call.
6. **TELEPHONE KEYPAD (1) to (oper) 0 Buttons:** Allows you to make a call depending on pressed button. (For TELEPHONE KEYPAD characters, see page 17.)
7. **TEMPORARY TONE (*) Button:** Press to temporarily change the DIALING mode from PULSE to TONE for Rotary Service Users. (Press once before entering numbers to access the answering system or electronic banking services, etc.)
8. **(voice mail/menu) Button:** (VOICE MAIL) Press to automatically dial the Voice Mail Post Code in your area to access your Voice Mail message. (MENU) Press to access the special functions operation in STANDBY mode. (For special functions see pages 20~25.)
9. **NEW CALL/MSG WAITING (MESSAGE WAITING) LED Indicator:** (NEW CALL) Blinks to indicate that you have a new Caller ID call stored in memory. (MESSAGE WAITING) Blinks at a slow rate when receiving a Message Waiting signal, if you have subscribed to a Voice Mail message service from your local telephone company. (See page 13.)
10. **HANDSET Volume Control (hi, mid, low) Switch:** Select the receiver volume level (HI, MID, LOW).
11. **BATT LOW INDICATOR:** Appears on the LCD Screen when the battery charge is low. (See page 27 for detail.)
12. **SCROLL UP-DOWN, SHIFT LEFT-RIGHT (↕) Button:** Press to move around the Large LCD Screen.
13. **HEADSET JACK:** For connecting your headset plug to enjoy hands-free communication. (See page 11 for detail.)
14. **(#)/option Button:** (OPTION) Press to change the displayed telephone number to 7, 10, or 11 digit DIALING mode during Caller ID callback.
15. **(del/chan) (DELETE/CHANNEL) Button:** (DELETE) - Press and hold down to delete items or individual characters. (CHANNEL) Press to change the operating channel when you hear interference.
16. **(flash/edit) Button:** (EDIT) Press to edit listed items. (FLASH) Press to answer a call if you have Call Waiting.
17. **CHARGE CONTACTS:** For charging the BATTERY PACK inside the **HANDSET**. We recommend cleaning the CHARGE CONTACTS periodically with a damp cloth.

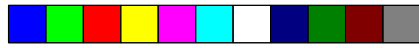

BASE UNIT Controls

1. TELEPHONE LINE
CONNECTION JACK
Pg. 5, 6, 9, 30

2. POWER-IN
CONNECTION JACK
Pg. 5, 6

3. TONE/PULSE
SELECT SWITCH
Pg. 6, 30

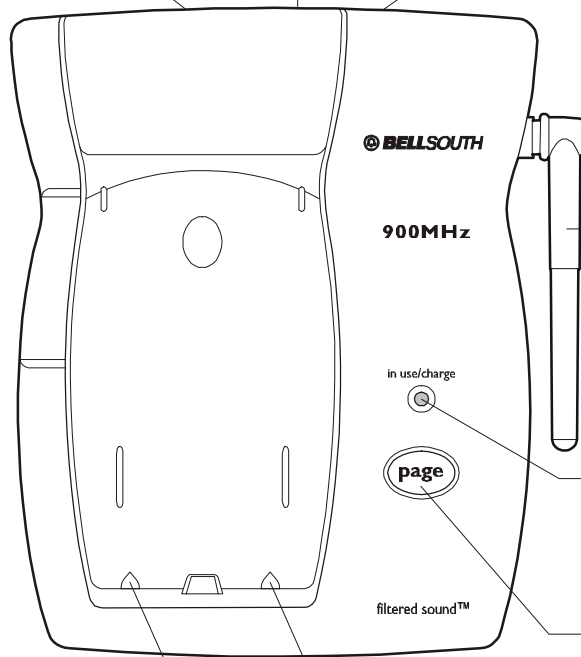

4. BASE UNIT
ANTENNA
Pg. 5, 10, 30, 31

5. IN USE/CHARGE
LED INDICATOR
Pg. 10, 11

6. PAGE BUTTON

7. CHARGE TERMINALS

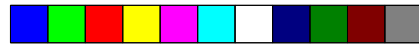

BASE UNIT Controls

1. **TELEPHONE LINE CONNECTION JACK**
2. **POWER-IN CONNECTION JACK**
3. **TONE/PULSE Select Switch**
4. **BASE UNIT ANTENNA:** Raise or reposition for the best reception.
5. **IN USE/CHARGE LED Indicator:** (IN USE) Lights up to indicate that the **HANDSET** is in TALK mode. (CHARGE) Lights up when the **HANDSET** is placed on the **BASE UNIT** for charging.
6.  **Button:** Press to page the **HANDSET**.
7. **CHARGE TERMINALS:** For charging the **HANDSET BATTERY PACK**. For best performance, clean the CHARGE TERMINALS periodically with a damp cloth.



IMPORTANT

Placing your **BASE UNIT** near appliances such as televisions, refrigerators, radios, or microwave ovens may cause interference.



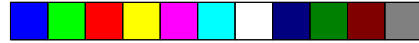

Contents

Safety Instructions.....	3
Getting Started.....	5
Desk Mounting.....	8
Wall Mounting.....	8
Cordless Telephone Operation.....	9
Preparing for Use.....	9
Receiving Calls.....	9
Placing Calls.....	10
Redial Feature.....	10
Using the Headset Feature.....	11
Caller ID System Operation.....	12
Caller ID System.....	12
Viewing Caller Information During Incoming Calls.....	12
Caller ID with Call Waiting.....	13
Message Waiting.....	13
One-Touch Voice Mail Dialing.....	13
Caller List.....	14
Viewing the Caller List.....	14
Placing a Call from the Caller List.....	14
Storing Caller ID Records into the DIRECTORY (PHONEBOOK).....	15
Deleting a Single Record in the Caller List.....	15
Deleting all Records in the Caller List.....	15
Name and Telephone Number DIRECTORY (PHONEBOOK).....	16
Viewing the DIRECTORY (PHONEBOOK).....	16
Storing Phone Numbers.....	16
Telephone Keypad Characters.....	17
Placing Calls from the DIRECTORY (PHONEBOOK).....	18
Editing a Stored Number in the DIRECTORY (PHONEBOOK).....	18
Deleting a Stored Number in the DIRECTORY (PHONEBOOK).....	19
Preferred Calls.....	19
Blocked Calls.....	19

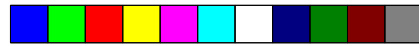

Contents



Function Settings.....	20
A. Setting the Ringer Level.....	21
B. Changing the Language.....	21
C. Turning the First Ring ON or OFF.....	22
D. Setting the Time and Date.....	22
E. Adjusting the Contrast.....	23
F. Setting the PBX Number.....	23
G. Changing the Flash Time.....	23
H. Changing the Pause Time.....	24
I. Programming One-Touch Voice Mail Dialing.....	24
J. Deleting Message Waiting Indication.....	25
K. Setting the Area Code.....	25
Security.....	26
Recharging the BATTERY PACK.....	27
Changing the BATTERY PACK.....	28
Problem Solving.....	29
Technical Information.....	30
FCC Requirements.....	31
Warranty Information.....	33
Wall Mount Template.....	37

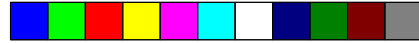

Safety Instructions

IMPORTANT SAFETY INSTRUCTIONS

To reduce the risk of fire, electric shock and/or injury, always follow these basic safety precautions when using your cordless telephone equipment.

1. Read and understand all instructions.
2. Follow all warnings and instructions marked on the telephone.
3. Do not use this telephone near a bathtub, wash bowl, kitchen sink, or laundry tub, in a wet basement, near a swimming pool, or anywhere else where there is water.
4. Avoid using a telephone (other than a cordless type) during an electrical storm. There may be a remote risk of electric shock from lightning.
5. Do not use the telephone to report a gas leak in the vicinity of the leak.
6. Use only the power cord and BATTERY PACK indicated in the Owner's Manual. Do not dispose of the BATTERY PACK in a fire. The BATTERY PACK may explode. Check with local codes for possible special disposal instructions.
7. Operate this telephone using the electrical voltage as stated on the **BASE UNIT** or in the Owner's Manual. If you are not sure of the voltage in your home, consult your dealer or local power company.
8. Unplug this telephone from the wall outlet before cleaning or replacing the BATTERY PACK. Do not use liquid cleaners or aerosol cleaners on the telephone. Use a damp cloth for cleaning.
9. Place this telephone on a stable surface. Serious damage and/or injury may result if the telephone falls.
10. Do not cover the slots and openings on this telephone. This telephone should never be placed near or over a radiator or heat register. This telephone should not be placed in a built-in installation unless proper ventilation is provided.
11. Do not place anything on the power cord. Install the telephone where no one will step or trip on the cord.
12. Do not overload wall outlets or extension cords as this can increase the risk of fire or electric shock.
13. Never push any objects through the slots in the telephone. They could touch dangerous voltage points or short out parts that could result in a risk of fire or electric shock. Never spill liquid of any kind on the telephone.
14. To reduce the risk of electric shock, do not take this telephone apart. If service or repair work is required on this telephone, take it to a qualified service representative. Opening or removing covers may expose you to dangerous voltage or other risks. Incorrect reassembly can cause electric shock when the appliance is subsequently used.
15. Unplug this telephone from the wall outlet and consult a qualified service representative in any of the following situations.
 - A. When the power supply cord is frayed or damaged.
 - B. If liquid has been spilled into the telephone.
 - C. If the telephone has been exposed to rain or water.
 - D. If the telephone does not operate normally by following the operating instructions. Adjust only those controls that are covered by the operating instructions. Improper adjustment may require extensive work by a qualified technician to restore the telephone to normal operation.

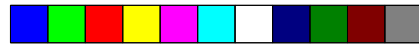

Safety Instructions

- E. If the telephone has been dropped or the case has been damaged.
- F. If the telephone exhibits a distinct change in performance.
- 16. Never install telephone wiring during a lightning storm.
- 17. Never install telephone jacks in wet locations unless the jack is specifically designed for wet locations.
- 18. Never touch uninsulated telephone wires or terminals unless the telephone line has been disconnected at the network interface.
- 19. Use caution when installing or modifying telephone lines.

Battery Safety

CAUTION:

Danger of explosion if BATTERY PACK is incorrectly replaced. Replace only with the same or equivalent type. To reduce the risk of fire or personal injury, read and follow these instructions:

1. Use only the following type and size of BATTERY PACK:
Cordless Telephone BATTERY PACK
3.6V, 600mAh
U.S. Electronics Inc.
Ni-Cd BATTERY PACK: model B650
(See page 27 for ordering information.)
2. Do not dispose of the BATTERY PACK in a fire. It may explode. Check with local codes for possible special disposal instructions.
3. Do not open or mutilate the BATTERY PACK. Released electrolyte from a BATTERY PACK is corrosive and may cause damage to the eyes or skin. Electrolyte may be toxic if swallowed.
4. Exercise care in handling the BATTERY PACK to prevent shorting the BATTERY PACK with conductive materials such as rings, bracelets and keys. The BATTERY PACK or conductor may overheat and cause burns.
5. Charge the BATTERY PACK provided with (or identified for use with) this telephone only in accordance with the instructions and limitations specified in this manual.
6. Observe proper polarity orientation between the BATTERY PACK and BATTERY CHARGER.

SAVE THESE INSTRUCTIONS

ATTENTION:

The telephone that you have purchased contains a rechargeable BATTERY PACK. The BATTERY PACK is recyclable. At the end of its useful life, under various state and local laws, it may be illegal to dispose of this BATTERY PACK into the municipal waste stream. Check with your local solid waste officials for details in your area for recycling options or proper disposal.

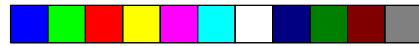

Getting Started

Connecting Your Phone

This section is a reference guide to the basic functions and operations of your cordless telephone. For more detailed descriptions of the operations and features of this telephone, refer to the Contents on page 1.

1. Carefully remove your cordless telephone from its shipping carton. If there is any visible damage, do not attempt to operate this equipment. Return it to the place of purchase.
2. Check to be sure you have all items that come with this cordless telephone system. You should have a **HANDSET**, **BASE UNIT**, AC ADAPTOR, BATTERY PACK, MOUNTING BRACKET, TELEPHONE LINE CORD, SHORT TELEPHONE LINE CORD, BELT CLIP, and Owner's Manual.



HANDSET

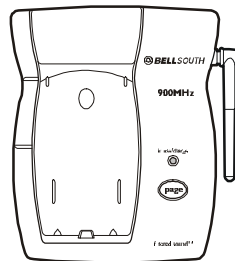

BASE UNIT

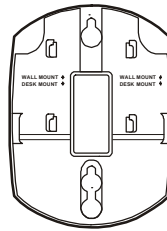

MOUNTING BRACKET

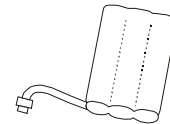

BATTERY PACK



BELT CLIP

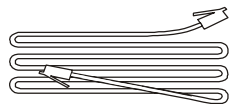

TELEPHONE LINE CORD



SHORT TELEPHONE LINE CORD

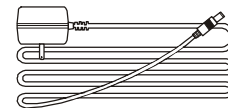

AC ADAPTOR

3. Insert the small plug on the end of the AC ADAPTOR into the POWER-IN CONNECTION JACK at the back of the **BASE UNIT**.
4. Plug the AC ADAPTOR into a 120V AC wall outlet.
USE ONLY WITH CLASS 2 POWER SOURCE 9V DC, 300mA.
5. Insert one plug of the TELEPHONE LINE CORD into the house TELEPHONE JACK and the other end into the TELEPHONE LINE CONNECTION JACK at the back of the **BASE UNIT**. (If you have an older 4-prong TELEPHONE JACK, you will need an RJ-11C TELEPHONE JACK ADAPTOR. This adaptor is available at the same place you purchased your telephone.)
6. Raise or reposition the ANTENNA on the **BASE UNIT** for the best reception.
7. We recommend not placing this unit next to appliances. Doing so may cause interference.

Getting Started

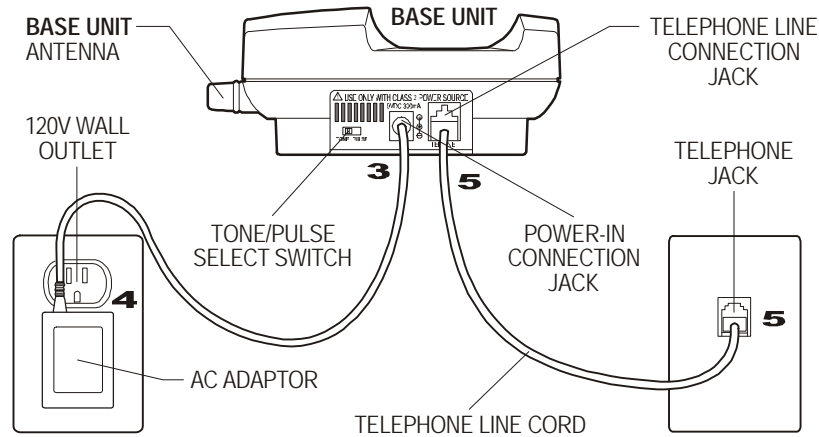

8. Install the **HANDSET BATTERY PACK** by plugging it into the **BATTERY CONNECTOR** inside the **BATTERY COMPARTMENT**.
9. Place the **BATTERY PACK** inside the **BATTERY COMPARTMENT**.
10. Slide the **HANDSET BATTERY COMPARTMENT COVER** firmly into place in its closed position.
11. **IMPORTANT: Before initial use, charge the HANDSET for 12 hours.**
12. **TONE/PULSE Select Switch:**
 - A. If your home is equipped with a tone dialing system, set the **TONE/PULSE Select Switch** to the **TONE** position.
 - B. If you have a rotary dialing system, set the **TONE/PULSE Select Switch** to the **PULSE** position.
 - C. If you are not sure which system you have, set the **TONE/PULSE Select Switch** to the **TONE** position. Press the **TALK** button on the **HANDSET** to get a dial tone, and press any button on the **TELEPHONE KEYPAD** except the zero. If the dial tone continues, it means that you do not have **TONE** dialing service. Press the **TALK** button on the **HANDSET** to hang up. Set the **TONE/PULSE Select Switch** to the **PULSE** mode and then try again.
13. Set the date and time on the **HANDSET**. (See page 22 for details.)

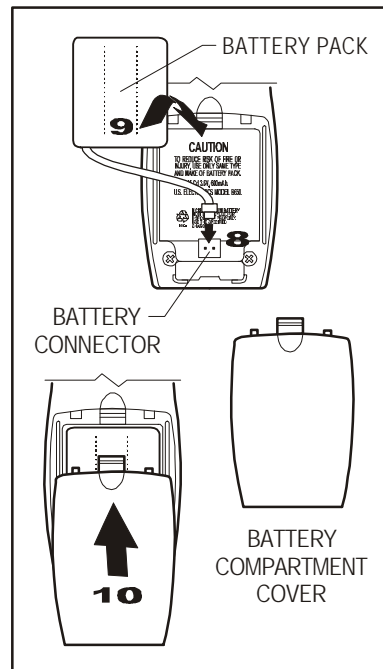

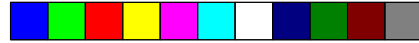

Getting Started

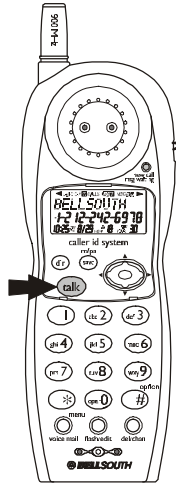

Press the **talk** button to confirm that you have a dial tone. If you do not get a dial tone, review steps 3 through 12. If you still do not have a dial tone, refer to the Problem Solving section on page 29.

Belt Clip Installation

With the back of the **HANDSET** facing up, insert one side of the **BELT CLIP HOOK** into the matching slot at the top side of the **HANDSET**. Press down on the opposite side of the **BELT CLIP** until the other hook locks into the slot on the side of the **HANDSET**.

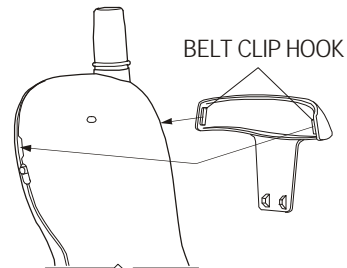

You are now ready to use your new BellSouth Cordless Telephone.

IMPORTANT

In order to utilize the Caller ID feature, you must subscribe to Caller ID service from your local telephone company.

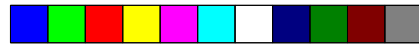

Desk Mounting

Desk Mounting

One of the special features of your telephone is the unique design of the MOUNTING BRACKET which can hold your phone at an angle of 30° when desk mounting. There are two positions to choose from:

1. NORMAL POSITION (MOUNTING BRACKET not required):

For normal position, as shown in Figure 1, place the **BASE UNIT** on any desired but suitable location.



FIGURE 1

2. 30° POSITION (See Figure 2):

With the back of the **BASE UNIT** facing up, insert the hooks of the MOUNTING BRACKET (following the arrow direction for the DESK MOUNT) into the upper four slots of the **BASE UNIT**. Then slide the MOUNTING BRACKET upward until it locks into place.

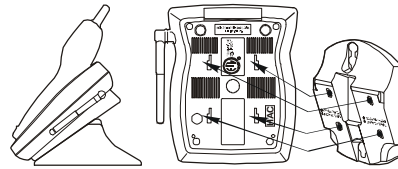

FIGURE 2

FIGURE 3

Wall Mounting

You may choose to put the **BASE UNIT** of your cordless telephone on a wall.

1. With the back of the **BASE UNIT** facing up, connect the **SHORT TELEPHONE LINE CORD** to the **TELEPHONE LINE CONNECTION JACK**.
2. Insert the free end of the **SHORT TELEPHONE LINE CORD** through the hole of the **MOUNTING BRACKET**.
3. Insert the hooks of the **MOUNTING BRACKET** into the matching slots on the back of the **BASE UNIT** (following the arrow direction for the **WALL MOUNT**) then slide the **MOUNTING BRACKET** until it locks into place.
4. Plug the free end of the **SHORT TELEPHONE LINE CORD** into the **MODULAR WALL JACK**.
5. Align the upper keyhole of the **MOUNTING BRACKET** with the upper stud of the wall plate, so that the opening end of the **MOUNTING BRACKET** matches the lower stud, then pull the **BASE UNIT** down until it is securely seated.
6. Pull out the **HANDSET RETAINER TAB** on the **BASE UNIT**, then place the **HANDSET** in the **BASE UNIT CHARGE CRADLE**.

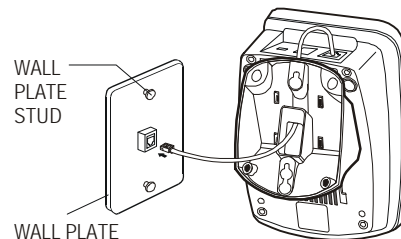
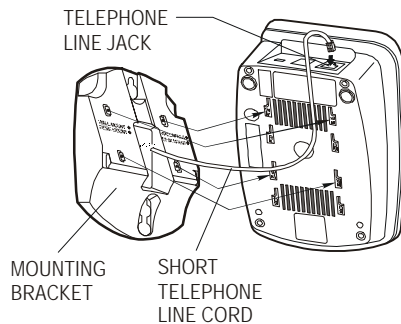

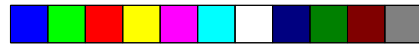

Cordless Telephone Operation

Preparing for Use

Before you can use your cordless telephone, you must charge the **HANDSET** for 12 hours. Failure to do so will require recharging of the **BATTERY PACK** more often.

1. Place the **HANDSET** on the **BASE UNIT** for 12 hours.
2. After 12 hours, remove the **HANDSET** from the **BASE UNIT**.
3. Raise or reposition the **BASE UNIT ANTENNA** for the best reception.

Before you can use your cordless telephone, you must charge the HANDSET for 12 hours. Failure to do so will require more frequent charging of the BATTERY PACK. See page 27 for more information on the BATTERY PACK.

NOTE:

Depending on the frequency of use, once the **HANDSET** is fully charged, it remains functional for approximately 4 hours of continuous use and approximately 5 days when the **HANDSET** is off the **BASE UNIT** in **STANDBY** mode.

Receiving Calls

1. When the phone rings, the LCD Screen will show "RING." If you have Caller ID, the LCD Screen will show the Caller ID information after the first ring.
2. With the **HANDSET** off the base, press the **talk** button. Start your conversation. The Call Timer starts to count.
3. To end your conversation, either press the **talk** button or place the **HANDSET** on the **BASE UNIT**. If you place the **HANDSET** on the **BASE UNIT CHARGE CRADLE**, you activate the **AUTOMATIC STANDBY** feature.

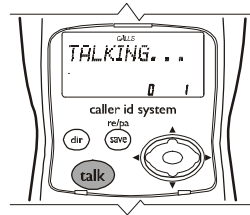

NOTE: The Call Timer will start to count once you press the **talk** button.

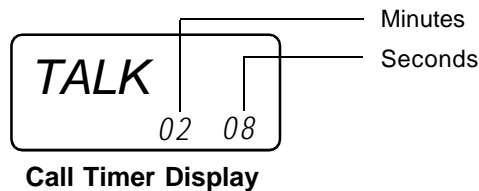

Cordless Telephone Operation

Placing Calls

1. Press the **talk** button, the Call Timer starts to count.
2. Wait until you hear a dial tone and then dial the phone number.
3. When you have finished your call, press the **talk** button again or place the **HANDSET** on the **BASE UNIT**.

OR

1. Dial the phone number.
2. Press the **talk** button. The number displayed will be dialed.
3. When you have finished with your call, press the **talk** button again or place the **HANDSET** on the **BASE UNIT**.

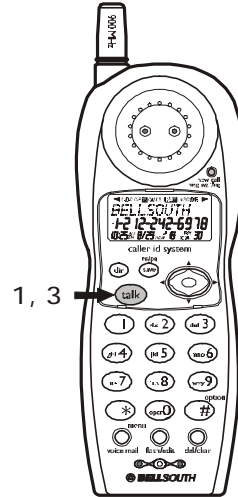

Redial Feature

1. If you get a busy tone, press the **talk** button or place the **HANDSET** on the **BASE UNIT** to hang up.
2. Later, press the **talk** button again.
3. Listen for a dial tone.
4. Press the **save/re/pa** button. This will automatically redial the last telephone number you called.
5. When you have finished with your call, press the **talk** button again or place the **HANDSET** on the **BASE UNIT**.

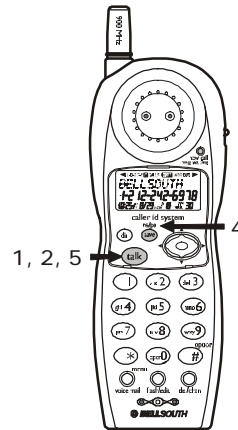

NOTE:

If you are too far away from the **BASE UNIT**, the **HANDSET** emits “beep” sounds to warn you that the background noise level is too high for proper communication between the **HANDSET** and the **BASE UNIT**. When you hear this sound, you should move closer to the **BASE UNIT** to reduce the noise level. Otherwise, the call will automatically cut off.

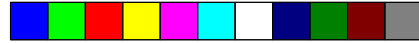

Cordless Telephone Operation

Using the Headset Feature

Your telephone can utilize a headset (not included) to be connected to your **HANDSET** for you to enjoy hands-free communication.

Insert the small plug on the end of the headset into the **HEADSET JACK** at the left side of the **HANDSET**. Follow the procedures discussed in "Receiving Calls" and "Placing Calls" to receive and place a call.

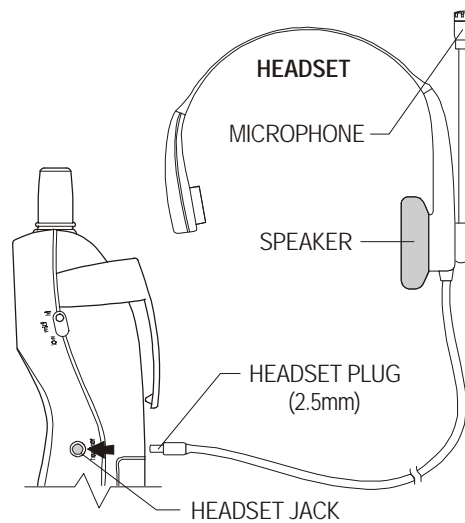

NOTE:

When you plug the headset plug into the **HEADSET JACK** it automatically mutes the **MICROPHONE** and **SPEAKER** of the **HANDSET**. Unplug the headset to return the **HANDSET** to normal use.

Headsets are available at most retail outlets that sell telephone equipment. The **HEADSET JACK** is compatible with 2.5 mm headset plugs only.

IMPORTANT

Placing your **BASE UNIT** near appliances such as televisions, refrigerators, radios, or microwave ovens may cause interference.

Caller ID System Operation

Caller ID System

This telephone automatically displays an incoming caller's name and telephone number together with the date and time of the call. It records up to 80 calls and stores the data in Memory.

IMPORTANT: You must subscribe to the Caller ID service from your local telephone company to utilize this feature.

Viewing Caller Information During Incoming Calls

1. When there is an incoming call, the name and the telephone number of the caller will automatically appear after the first ring. Press the SHIFT RIGHT  button to view a name of more than 11 digits.

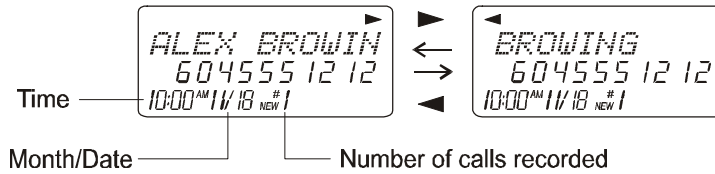

OR

Caller's telephone number will appear if the caller's name is not available.

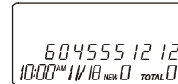

OR

"UNAVAILABLE" will appear when Caller ID information is not available. The origin of the call does not support the Caller ID system (including international calls).

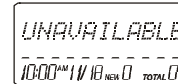

OR

"DATA ERROR" will appear when the Caller ID information was received incorrectly or only part of the data was received.

NOTE: When an error is received, none of the data from this call is saved in memory.



OR

"PRIVATE" will appear if the caller's name and/or telephone number is blocked.



OR

"MSG WAITING" will appear when a Voice Mail Message has been received and is stored by the Message Waiting service provided by the telephone company.

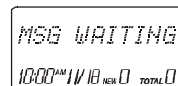

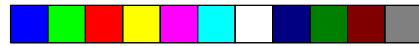

Caller ID System Operation

Caller ID with Call Waiting

When you subscribe to Call Waiting service from your local telephone company, this telephone will display the name and number of the second caller while you are having a conversation with the first caller.

When a new call comes in while you are talking, you will hear a notification beep from the **HANDSET** and the volume is momentarily muted. The new caller's name and phone number, if available, appears on the display.

ALEX BROWN
604555 12 12
01:02 SEC

Second
Caller

ABEL BROWN
6042254242
10:00 AM 11/18 NEW 1 0PT 3

First
Caller

1. When you receive a "Call Waiting" call and you want to connect the call, press the **flash/edit** button and start talking with the second caller. The active call will be placed on hold.
2. Press the **flash/edit** button to alternate between calls.
3. Press the **talk** button or place the **HANDSET** on the **BASE UNIT** to end the call.

"MSG WAITING" (Message Waiting)

The Message Waiting LED indicator will blink when there is a message for you from your telephone company if you have subscribed to Voice Mail message service and if you have requested Visual Message Indication from your local telephone company. "MSG WAITING" will appear on the LCD Screen in STANDBY mode. (To remove the MSG WAITING indicator, see page 25 for detail.)

Note: This function requires voice mail subscription from the local telephone company. Furthermore, the local phone company must provide a type of voice mail signaling called "FSK" (Frequency Shift Key). Not all telephone companies have the visual message waiting feature available. Please contact your local telephone company to check if this is available in your area.

One-Touch Voice Mail Dialing

When the setting is programmed in the Functions menu (see "Programming One-Touch Voice Mail Dialing" on page 24) you can dial out a programmed number at the touch of a button. This feature is specifically designed to easily check voice mail when you have that service through your local telephone company.

1. Press the **talk** button to access the telephone line.
2. Press the **voice mail/menu** button.
3. The phone will automatically dial the number.

Caller ID System Operation

Caller List

This phone automatically stores the last 80 calls received. It records call information such as caller's name and telephone number together with the date and time of the call. The NEW CALL LED indicator will blink to indicate that you have a new Caller ID call stored in memory.

Viewing the Caller List

1. With the **HANDSET** in **STANDBY** mode, press the **SCROLL UP** (▲) or **DOWN** (▼) button.
2. Any unviewed (new) calls will be displayed first. The most recent call will be displayed. The information on the call will be displayed with the name, number, date, and time that the call was received.



3. To scroll to the next call, press the **SCROLL UP** (▲) or **DOWN** (▼) button. Pressing the **SCROLL DOWN** (▼) button will go through the calls from the last call received to the first Caller ID record. Pressing the **SCROLL UP** (▲) button will allow you to view the calls from the first call received to the last.
4. If the name or number is more than 11 characters, press the **SHIFT RIGHT** (▶) button to view the rest of the display as indicated by the arrows in the top line of the LCD Screen. Press the **SHIFT LEFT** (◀) button to return to the previous display.
5. Press the **DIR** button to return to **STANDBY** mode.

Placing a Call from the Caller List

You can place a call from the Caller list by using the Caller ID **CALLBACK** feature.

1. Press the **SCROLL UP** (▲) or **DOWN** (▼) button to find the record you wish to call back.

2. Press the **#/option** button to change the displayed number to 7, 10, or 11 digits. The first dialing option displayed is the 11 digits for a long distance call.

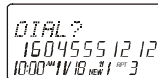

First press.

Press the **#/option** button for the second time, the displayed number will change to 7 digits for a local call.

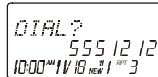

Second press.

Press the **#/option** button for the third time, the displayed number will change to 10 digits for a local call with area code.



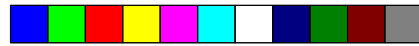

Third press.

3. Press the **talk** button to dial the displayed number.
4. To end a call, either press the **talk** button or place the **HANDSET** on the **BASE UNIT**.



Caller ID System Operation

Storing Caller ID Records into the DIRECTORY (PHONEBOOK)

1. Press the SCROLL UP  or DOWN  button to find the record you wish to store into the DIRECTORY (PHONEBOOK).
2. Press and hold the  button.
3. The display will show "SAVED."

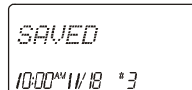



SAVED
10:00 AM 11/18 *3

4. If you wish to edit the newly stored number, edit it in the DIRECTORY (PHONEBOOK) (page 18, "Editing a Stored Number").
5. Press the  button to return to STANDBY mode.

Deleting Caller ID Records

When viewing the Caller ID information you can delete a single call record or all of the call records.

Deleting a Single Record

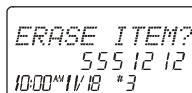

1. Press the SCROLL UP  or DOWN  button to find the record you wish to delete.
2. Press the  button. The LCD Screen will display "ERASE ITEM?"



ERASE ITEM?
555 12 12
10:00 AM 11/18 *3

3. To delete the record, press the  button. The LCD screen will show "ERASED."
4. Press the  button to exit the Caller ID list.

Deleting All Records

1. Press the SCROLL UP  or DOWN  button.
2. Press and hold the  button. The LCD screen will prompt "ERASE ALL?"

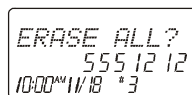

ERASE ALL?
555 12 12
10:00 AM 11/18 *3

3. To delete all of the Caller ID records, press the  button. The LCD Screen will show "ALL ERASED" and then return to STANDBY mode.

Caller ID System Operation

Name and Telephone Number DIRECTORY (PHONEBOOK)

This DIRECTORY (PHONEBOOK) lets you scroll through the list to find the person you need for one touch dialing. You can store up to 40 names and telephone numbers in the Memory.

Viewing the DIRECTORY (PHONEBOOK)

1. Press the **DIR** button.
2. Press the TELEPHONE KEYPAD (**abc 2**) to (**wxy 9**) button that corresponds to the first letter of a Caller's name (a triple "beep" will sound if no entries are stored under those letters). Press the SCROLL UP (**▲**) or DOWN (**▼**) button to find the record you wish to view.
3. If the name or number is more than 11 characters, press the SHIFT RIGHT (**▶**) or LEFT (**◀**) button to view the rest of the display (as indicated by the arrows in the top line of the LCD Screen).
4. Press the **dir** button to exit the DIRECTORY (PHONEBOOK), or the DIRECTORY (PHONEBOOK)time out.

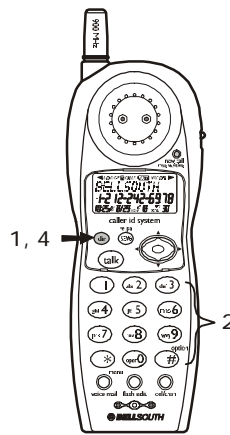

Storing Phone Numbers

1. With the **HANDSET** in STANDBY mode, press the **dir** button.
2. Press the **flash/edit** button to create a new DIRECTORY (PHONEBOOK) entry.
3. Enter the name you wish to store using the TELEPHONE KEYPAD (**abc 2**) to (**wxy 9**) buttons to enter the name, (see page 17 for detail) you can store up to 18 letters. To move the cursor to the right, create a space or to enter a new letter, press the SHIFT RIGHT (**▶**) button.
4. Press the SCROLL DOWN (**▼**) button, and dial the telephone number you wish to store using the TELEPHONE KEYPAD (**1**) to (**oper 0**) buttons. You can store up to 22 digits. Press the **save/re/pa** button to insert a pause into the number.
5. Press the **save/re/pa** button to store the number into memory.

NOTES:

1. If there are no memory locations left in the speed dial directory (phonebook) the LCD screen will display "MEMORY FULL." To continue with memory programming, you must delete or edit existing speed dial numbers.
2. If you mis-type entering the phone number, you can move through the number and edit it by pressing the SHIFT RIGHT (**▶**) or LEFT (**◀**) button. To delete a character or number inside the cursor, press the **del/chan** button.

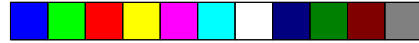

Caller ID System Operation

Telephone Keypad Characters

The TELEPHONE KEYPAD buttons are used to enter characters when entering names and numbers. Press the appropriate TELEPHONE KEYPAD button to get the following characters. You can store a maximum of 18 characters on the letter icon and a maximum of 22 digits on the number icon.

Keypad Buttons	1st Press	2nd Press	3rd Press	4th Press	5th Press	6th Press	7th Press	8th Press	9th Press
1	Space	1	&	'	()	.	Space	1
2	A	B	C	a	b	c	2	A	B
3	D	E	F	d	e	f	3	D	E
4	G	H	I	g	h	i	4	G	H
5	J	K	L	j	k	l	5	J	K
6	M	N	O	m	n	o	6	M	N
7	P	Q	R	S	p	q	r	s	7
8	T	U	V	t	u	v	8	T	U
9	W	X	Y	Z	w	x	y	z	9
0	0	0	0	0	0	0	0	0	0
*	*	*	*	*	*	*	*	*	*
#	#	#	#	#	#	#	#	#	#

EXAMPLE:

If you want to enter the name "ALEX" with telephone number "2426978," dial this sequence:

1. Press the button.
2. Press the button to create a new DIRECTORY (PHONEBOOK) entry.
3. Press the following TELEPHONE KEYPAD buttons to get the desired letters:

TELEPHONE KEYPAD BUTTON	2	555	33	99
LETTER	A	L	E	X

4. Press the SCROLL DOWN button to move the cursor to the number icon.
5. Press the following TELEPHONE KEYPAD buttons to get the desired numbers:

TELEPHONE KEYPAD BUTTON	2222222	4444444	2222222	6666666	999999999	777777777	88888888
TELEPHONE NUMBER	2	4	2	6	9	7	8

6. Press the button to store the data in the DIRECTORY (PHONEBOOK) memory.

Caller ID System Operation

Placing Calls from the DIRECTORY (PHONEBOOK)

1. Press the **dir** button.
2. Press the SCROLL UP **▲** or DOWN **▼** button to find the record you want to call.

OR

Press a TELEPHONE KEYPAD (**abc 2** to **wxy 9**) which group corresponds to the first letter of a name. Press the SCROLL UP **▲** or DOWN **▼** button to find the record you wish to call.

3. Press the **#/option** button to change the displayed number to 7, 10, or 11 digits. The first dialing option displayed is the 11 digits for a long distance call.



DIAL?
1604555 12 12
10:00 AM 11/18 #1 TOTAL 3

First press.

Press the **#/option** button for the second time, the displayed number will change to 7 digits for a local call.

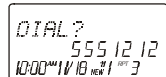

DIAL?
555 12 12
10:00 AM 11/18 #1 TOTAL 3

Second press.

Press the **#/option** button for the third time, the displayed number will change to 10 digits for a local call with area code.



DIAL?
604555 12 12
10:00 AM 11/18 #1 TOTAL 3

Third press.

4. Press the **talk** button to dial the displayed number.
5. To end the call, either press the **talk** button or place the **HANDSET** on the **BASE UNIT**.

Editing a Stored Number in the DIRECTORY (PHONEBOOK)

1. Press the **dir** button.
2. Press the SCROLL UP **▲** or DOWN **▼** button to find the record you wish to edit.
3. Press the **flash/edit** button. The entry will display with a flashing prompt over the first character.

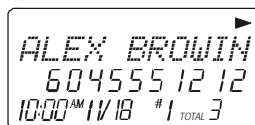

ALEX BROWIN
604555 12 12
10:00 AM 11/18 #1 TOTAL 3

4. Move the cursor to the letter or number you wish to edit by pressing the SCROLL UP **▲** or DOWN **▼**, SHIFT RIGHT **▶** or LEFT **◀** button.

To erase a character or digit, press the **del/chan** button.

To add a letter or number, use the TELEPHONE KEYPAD **1** to **oper 0** buttons. Characters or numbers will be inserted in front of the cursor (See page 17 for details.)

5. When the entry is edited as you desire, press and hold the **save/re/pa** button to store the edited record.

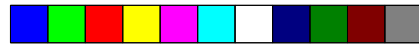

Caller ID System Operation

Deleting a Stored Number in the DIRECTORY (PHONEBOOK)

1. Press the **dir** button.
2. Press the SCROLL UP **▲** or DOWN **▼** button to find the record you wish to delete.
3. Press the **del/chan** button. The LCD screen will display "ERASE ITEM?"

```

ERASE ITEM?
  555 12 12
10:00AM 11/18 #3
  
```

4. To delete the record, press the **del/chan** button.
5. Press the **dir** button to return to STANDBY mode.

PREFERRED CALLS

You can assign stored numbers a PREFERRED CALL status. When an incoming call is matched to a stored number designated as preferred, the phone will generate a special ringer sound after the Caller ID information is received.

When you are saving the name and number into the DIRECTORY (PHONEBOOK), add a "#" symbol at the beginning of the name by pressing the **#** button.

```

#ALEX BROWI
  604555 12 12
10:00AM 11/18 #1 TOTAL 3
  
```

BLOCKED CALLS

You can assign stored numbers a BLOCKED CALL status. When an incoming call is matched to a stored number designated as blocked, the phone will not ring after the Caller ID information is received.

When you are saving the name and number into the DIRECTORY (PHONEBOOK), add an "*" symbol at the beginning of the name by pressing the ***** button.

```

*ALEX BROWI
  604555 12 12
10:00AM 11/18 #1 TOTAL 3
  
```

IMPORTANT

In order to utilize the Caller ID feature, you must subscribe to Caller ID service from your local telephone company.





Caller ID System Operation











Function Settings

You can change the setting on the **HANDBSET** in the functions menu. Access the functions menu by pressing and holding the **voice mail/menu** button.

There are 11 settings in the functions menu which can be changed. You can scroll through the function menu in the listed order by pressing the **SCROLL DOWN**  button.

Settings can be accessed by pressing the corresponding **TELEPHONE KEYPAD** button. To edit a setting, press the **flash/edit** button, use the **SCROLL UP**  or **DOWN**  button to toggle between the setting options, and then press and hold the **save/re/pa** button to save the changes. Press the **voice mail/menu** button to exit the functions menu.

TELEPHONE KEYPAD	Function
---------------------	----------

- | | |
|---|---|
|  | Ring Hi/Low/Off: Changes the volume of the ringer on the handset or turn the ringer OFF. |
|  | Language: Changes the language that appears on the LCD Screen. Choose between English, French, or Spanish. |
|  | First Ring On/Off: Turns the first ring of the phone OFF so that it does not ring until Caller ID information has been displayed. Particularly useful when using the preferred and blocked call features or the private and unavailable ring settings. |
|  | Time Set: Changes the time and date. |
|  | Contrast: Adjusts the brightness of the display for optimum viewing. |
|  | PBX Number: Inserts if a "PBX Number" before an outgoing number is dialed. Select the number (0-9) which is required to access an outside line when using a switchboard system, and the phone will automatically dial the PBX number and a pause before any speed dial or Caller ID callback number. Factory setting is "OFF." |
|  | Flash Time: Changes the flash time to accommodate the phone service in your area. |
|  | Pause Time: Changes the number of seconds that a pause lasts when using programmed pauses in your speed dial numbers or after your PBX number. |
|  | Voice Mail: Programs the one-touch number that enables easy access to the voice mail service provided by your telephone company. |

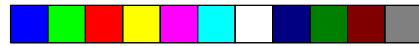

Caller ID System Operation

TELEPHONE KEYPAD Function





MSG Waiting Delete: Clears current message waiting indication.



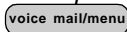



Area Code: This unit does not require any programming of an Area Code. However, this option could be used to add the local Area Code to numbers that were stored as 7-digits in the phone book and 10-digit dialing is required in the local calling area.

NOTE: At any time during options programming you can quit and the settings that you have changed will be saved. Press the  button to quit the options menu or let the options programming time out by not pressing any TELEPHONE KEYPAD buttons for 20 seconds.

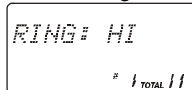

A. Setting the Ringer Level

1. Press and hold the  button to enter the menu.
2. Press the  button to change the setting. "HI" will begin flashing.





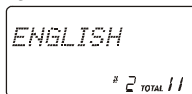

3. Press the SCROLL UP  or DOWN  button to toggle between HI, LOW, and OFF.
4. When the desired setting is displayed, press and hold the  button to save the setting. A long "beep" will sound to confirm the setting has been saved.
5. Continue with programming or press the  button to return to STANDBY mode.

B. Changing the Language

1. Press and hold the  button to enter the menu.
2. Press the  button to go to the LANGUAGE programming option.

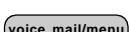

3. Press the  button to change the setting. "ENGLISH" will begin flashing.
4. Press the SCROLL UP  or DOWN  button to toggle between ENGLISH, ESPANOL, and FRANCAIS.
5. When the desired setting is displayed, press and hold the  button to save the setting. A long "beep" will sound to confirm the setting has been saved.
6. Continue with programming or press the  button to return to STANDBY mode.

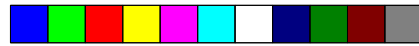

Caller ID System Operation



C. Turning the FIRST RING ON or OFF

1. Press and hold the **voice mail/menu** button to enter the menu.
2. Press the **def 3** button to go to the FIRST RING programming option.

FIRST RING
On
3 TOTAL 11

3. Press the **flash/edit** button to change the setting. "On" will begin flashing.
4. Press the SCROLL UP **▲** or DOWN **▼** button to toggle between ON and OFF.
5. When the desired setting is displayed, press and hold the **save /re/pa** button to save the setting. A long "beep" will sound to confirm the setting has been saved.
6. Continue with programming or press the **voice mail/menu** button to return to STANDBY mode.

D. Setting the Time and Date

1. Press and hold the **voice mail/menu** button to enter the menu.
2. Press the **ghi 4** button to go to the TIME set programming option.

TIME SET
10:00 AM 1/18 # 4 TOTAL 11

3. Press the **flash/edit** button to change the setting. The month will begin flashing.
4. Press the TELEPHONE KEYPAD **1** to **oper 0** button to enter the month. The date will begin flashing.
5. Press the TELEPHONE KEYPAD **1** to **oper 0** button to enter the date. The hour will begin flashing.
6. Press the TELEPHONE KEYPAD **1** to **oper 0** button to enter the hour. The minutes will begin flashing.
7. Press the TELEPHONE KEYPAD **1** to **oper 0** button to enter the minutes. "AM" and "PM" will begin flashing.
8. Press the TELEPHONE KEYPAD **1** button to choose AM or press the **abc 2** button to choose PM.
9. When the desired setting is displayed, press and hold the **SAVE /RE/PA** button to save the setting. A long beep will sound and you are returned to the options menu.
10. Continue with programming or press the **voice mail/menu** button to return to STANDBY mode.

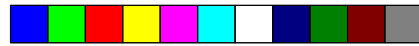

Caller ID System Operation

E. Adjusting the Contrast

1. Press and hold the **voice mail/menu** button to enter the menu.
2. Press the **jkt 5** button to go to the CONTRAST programming option.



3. Press the **flash/edit** button to change the setting. "4" will begin flashing.
4. Press the SCROLL UP **▲** or DOWN **▼** button to toggle from 1 to 8 levels of contrast.
5. When the desired setting is displayed, press and hold the **save /re/pa** button to save the setting. A long "beep" will sound to confirm the setting has been saved.
6. Continue with programming or press the **voice mail/menu** button to return to STANDBY mode.

F. Setting the PBX Number

1. Press and hold the **voice mail/menu** button to enter the menu.
2. Press the **mnc 6** button to go to the PBX NUMBER programming option.

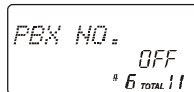

3. Press the **flash/edit** button to change the setting. "OFF" will begin flashing.
4. Press the SCROLL UP **▲** or DOWN **▼** button to customize the digit to match your PBX system. When not connected to a PBX, the phone will only function normally when set to "OFF."
5. When the desired setting is displayed, press and hold the **save /re/pa** button to save the setting. A long "beep" will sound to confirm the setting has been saved.
6. Continue with programming or press the **voice mail/menu** button to return to STANDBY mode.

G. Changing the Flash Time

1. Press and hold the **voice mail/menu** button to enter the menu.
2. Press the **prs 7** button to go to the FLASH TIME programming option.

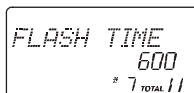

3. Press the **flash/edit** button to change the setting. "600" will begin flashing.
4. Press the SCROLL UP **▲** or DOWN **▼** button to select the desired dialing delay.

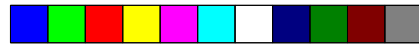

Caller ID System Operation



- When the desired setting is displayed, press and hold the **(save) /re/pa** button to save the setting. A long "beep" will sound to confirm the setting has been saved.
- Continue with programming or press the **(voice mail/menu)** button to return to STANDBY mode.

NOTE: The standard and default flash time setting is 600 msec. This is the setting you should use to access standard telephone services such as call waiting. This setting is adjustable to allow for PBX and other special uses.

H. Changing the Pause Time

- Press and hold the **(voice mail/menu)** button to enter the menu.
- Press the **(tuv) 8** button to go to the PAUSE TIME programming option.

PAUSE TIME
4
* 8 TOTAL !!

- Press the **(flash/edit)** button to change the setting. "4" will begin flashing.
- Press the SCROLL UP **(▲)** or DOWN **(▼)** button to select the desired time delay.
- When the desired setting is displayed, press and hold the **(save) /re/pa** button to save the setting. A long "beep" will sound to confirm the setting has been saved.
- Continue with programming or press the **(voice mail/menu)** button to return to STANDBY mode.

I. Programming One-Touch Voice Mail Dialing

- Press and hold the **(voice mail/menu)** button to enter the menu.
- Press the **(wxy) 9** button to go to the VOICE MAIL programming option.

VOICE MAIL
* 9 TOTAL !!

- Press the **(flash/edit)** button to enter the voice mail speed dial number.
- Press the TELEPHONE KEYPAD **(1)** to **(oper) 0** buttons to enter the phone number used to access your voice mail messages (up to 15 digits).
- When the desired setting is displayed, press and hold the **(save) /re/pa** button to save the setting. A long "beep" will sound to confirm the setting has been saved.
- Continue with programming or press the **(voice mail/menu)** button to return to STANDBY mode.

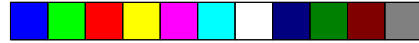

Caller ID System Operation

J. Deleting Message Waiting Indication

1. Press and hold the **voice mail/menu** button to enter the menu.
2. Press the **oper 0** button to go to the MESSAGE WAITING programming option.

MSG WAITING
* 10 TOTAL !!

3. Press the **flash/edit** button to reset the Message Waiting Indication. "DEL" will begin flashing.
4. Press the **save/re/pa** button to delete the indication. A long "beep" will sound to confirm the setting has been saved.
5. Continue with programming or press the **VOICE MAIL/MENU** button to return to STANDBY mode.

voice mail/menu

K. Setting the Area Code

1. Press and hold the **voice mail/menu** button to enter the menu.
2. Press the ***** button to go to the AREA CODE programming option.

AREA CODE
000
* 11 TOTAL !!

3. Press the **flash/edit** button to change the setting. "000" will begin flashing.
4. Press the TELEPHONE KEYPAD **1** to **oper 0** buttons to enter the three digit area code for your phone number.
5. When the desired setting is displayed, press and hold the **save/re/pa** button to save the setting. A long "beep" will sound to confirm the setting has been saved.
6. Press the **voice mail/menu** button to return to STANDBY mode.

NOTE:

To use the call back function, press the **#/option** button and then select the 10-DIGIT DIALING mode. Press the **talk** button and the unit will automatically dial the stored 7-digit number plus the area code.

IMPORTANT

In order to utilize the Caller ID feature, you must subscribe to Caller ID service from your local telephone company.

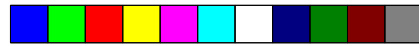

Security

Security System

Your cordless telephone uses a digital coding security system to prevent unauthorized use of your telephone line by another nearby cordless telephone. The system has its own identifying signal created by microcomputers in both the **BASE UNIT** and the **HANDSET**.

Security Code

This telephone has an internal security code with 65,536 possible combinations.

Resetting Security Code and Channel Information

Communication between the **HANDSET** and the **BASE UNIT** may not be possible in any of the following situations:

1. After a power failure.
2. After relocating the **BASE UNIT** by disconnecting the AC ADAPTOR.
3. After replacing the **HANDSET BATTERY PACK**.

To reset, place the **HANDSET** on the **BASE UNIT** for 2 to 5 seconds.

Multi-Channel Access

Your cordless telephone lets you select a channel from the 50 frequencies available to transmit signals between the **BASE UNIT** and the **HANDSET**. When you notice interference from other cordless telephones, change to another channel by pressing the  button on the **HANDSET**.

IMPORTANT

When you hear interference, press the  button to change the operating channel.

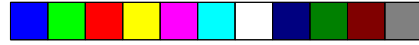

Recharging the BATTERY PACK

Battery Type

Use the following type and size of BATTERY PACK:

Cordless Telephone BATTERY PACK

3.6V, 600mAh

U.S. Electronics Inc.

Ni-Cd BATTERY PACK: Model B650



Ni-Cd

This BATTERY PACK is available through:

U.S. Electronics Service Center

105 Madison Avenue

New York, NY 10016

1-800-828-5208

NOTE: During a power interruption, the BASE UNIT does not operate, and a phone conversation cannot be made on the HANDSET.

Recharging the BATTERY PACK

The nickel cadmium (Ni-Cd) BATTERY PACK in the HANDSET can be recharged many times using the built-in charger in the BASE UNIT.

When the BATT LOW symbol appears on the LCD Screen, a "beep" sound will be heard every 10 seconds. This indicates that the BATTERY PACK needs to be recharged.

Charge the BATTERY PACK at least once every 90 days of non-use to avoid battery failure. When the BATTERY PACK can no longer be charged, replacement of the BATTERY PACK will be necessary.

The BATTERY PACK used in your telephone may develop a condition known as "MEMORY." Once subjected to a regular short discharging routine, the BATTERY PACK assumes the discharging pattern it was subjected to. This causes rapid discharging thereby shortening the BATTERY PACK charge span. If you believe your BATTERY PACK has developed a "MEMORY" condition, do not charge the HANDSET until the BATT LOW symbol appears on the LCD Screen. When the BATT LOW symbol appears on the LCD Screen, charge the HANDSET fully for 12 hours.

IMPORTANT

In order to get maximum life from the HANDSET BATTERY PACK, be sure to charge the HANDSET for 12 hours before initial use.

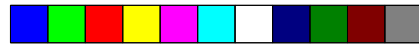

Changing the BATTERY PACK

Changing the BATTERY PACK

The BATTERY PACK provides power for the **HANDSET** of your cordless telephone.

To Replace the BATTERY PACK:

1. Remove the **HANDSET BATTERY COMPARTMENT COVER** by sliding it down.
2. Pull out the **BATTERY PACK PLUG** and remove the **BATTERY PACK**.
3. Plug the new **BATTERY PACK** into the **BATTERY CONNECTOR**.
4. Slide the **HANDSET BATTERY COMPARTMENT COVER** firmly into place in its closed position.
5. Before use, charge the new **BATTERY PACK** for 12 hours.

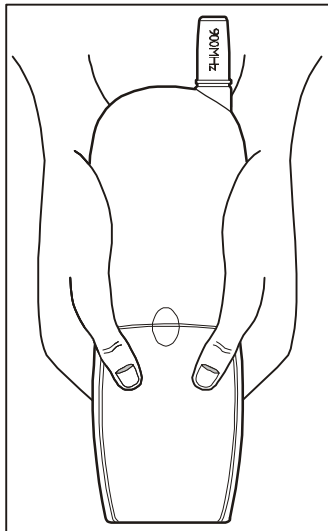

Remove the **HANDSET BATTERY COMPARTMENT COVER** by sliding it down.

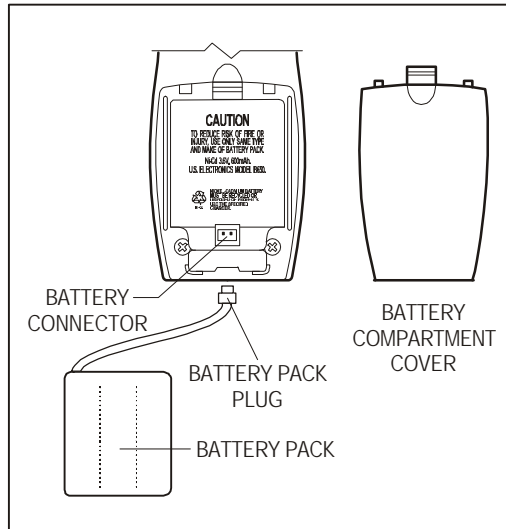

ATTENTION:

The telephone that you have purchased contains a rechargeable BATTERY PACK. The BATTERY PACK is recyclable. At the end of its useful life, under various state and local laws, it may be illegal to dispose of this BATTERY PACK into the municipal waste stream. Check with your local solid waste officials for details in your area for recycling options or proper disposal.

IMPORTANT

In order to get maximum life from the **HANDSET BATTERY PACK**, be sure to charge the **HANDSET** for 12 hours before initial use.

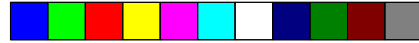

Problem Solving

Problem Solving Section

For your assistance, we have listed below a few common problems.

Phone does not work, check the following:

1. **BASE UNIT** is plugged into a power source.
2. **HANDSET** is charged.
3. TONE/PULSE Select Switch is in the right position.
4. TELEPHONE LINE CORD is plugged into the TELEPHONE JACK.

Range of phone limited, check the following:

1. **BASE UNIT** is centrally located in your residence.
2. **BASE UNIT** is not located near appliances.

No dial tone, check the following:

1. TELEPHONE LINE CORD plugs are connected to the TELEPHONE JACK and TELEPHONE LINE CONNECTION JACK.
2. **BASE UNIT** is plugged into a power source.
3. If you had a power failure or had unplugged the **BASE UNIT**, replace the **HANDSET** on the **BASE UNIT** for 2 to 5 seconds to reset the system.

Received signal flutters or fades, check the following:

1. BATTERY PACK in the **HANDSET** is fully charged.
2. **HANDSET** is not too far from the **BASE UNIT**.
3. ANTENNA on the **BASE UNIT** is raised.

Interference on reception, check the following:

1. Noise may be picked up from electrical products in the home or electrical storms. Generally, this noise is a minor annoyance and should not be interpreted as a defect in your system. (See Technical Information on page 30).
2. Choose an alternate channel using the  button on the **HANDSET**.

Excess static, check the following:

1. Check to see that the ANTENNA is not touching another metal object.

If after pressing the button, you receive three "beeps" and no dial tone, check the following:

1. **BASE UNIT** is plugged into a power source.
2. If you had a power failure or had unplugged the **BASE UNIT**, replace the **HANDSET** on the **BASE UNIT** for 2 to 5 seconds to reset the system.

NOTE:

If none of the telephones in the house are working, disconnect one set at a time to verify that none of the phones are causing the problem. If you still have a problem after doing this, and your telephone still does not work, please contact your local phone company.

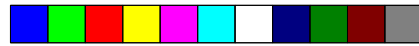

Technical Information

Technical Information

This cordless telephone uses radio frequencies to allow mobility. There are certain difficulties in using radio frequencies with a cordless telephone. While these are normal, the following could affect the operation of your system.

Noise

Electrical pulse noise is present in most homes at one time or another. This noise is most intense during electrical storms. Certain kinds of electrical equipment such as light dimmers, fluorescent bulbs, motors, and fans also generate noise pulses. Because radio frequencies are susceptible to these noise pulses, you may occasionally hear them in your **HANDSET**. Generally they are a minor annoyance and should not be interpreted as a defect in your system.

Range

Because radio frequency is used, the location of the **BASE UNIT** can affect the operating range. Try several locations in your home or office and pick the one that gives you the clearest signal to the **HANDSET**.

Interference

Electronic circuits activate a relay to connect the cordless telephone to your telephone line. These electronic circuits operate in the radio frequency spectrum. While several protection circuits are used to prevent unwanted signals, there may be periods when these unwanted signals enter the **BASE UNIT**. You may hear clicks or hear the relay activate while you are not using the **HANDSET**. If the interference occurs frequently, it can be minimized or eliminated by relocating the **BASE UNIT**. You can check for interference before selecting the final **BASE UNIT** location by plugging in the telephone.

NOTICE:

This cordless telephone uses radio communication between the **HANDSET** and the **BASE UNIT** and may not ensure privacy of communication. Other devices, including other cordless telephones, may interfere with the operation of this cordless telephone or cause noise during operation. Units not containing coded access may be accessed by other radio communication systems. Cordless telephones must not cause interference to any licensed radio service.

IMPORTANT

When you hear interference, press the  button to change the operating channel.

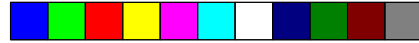

FCC Requirements

Federal Communications Commission Requirements

This equipment complies with Part 68 of the FCC Rules. A label on the **BASE UNIT** of this equipment contains, among other information, the ACTA product number and the Ringer Equivalence Number (REN) for this equipment. You must, upon request, provide this information to your telephone company.

The REN is also useful in determining the quantity of devices that you may connect to your telephone line and still allow these devices to ring when your telephone number is called. In most areas, but not all, the sum of the RENs for all devices connected to one line should not exceed five (5.0). To be certain of the number of devices that you may connect to your line, you should contact your local telephone company.

If your equipment should cause harm to the telephone network, the telephone company may temporarily disconnect your service. If possible, they will notify you in advance that temporary discontinuance of service may be required. However, when advanced written notice is not possible, the telephone company may temporarily discontinue service without notice if such action is necessary under the circumstances. The telephone company may make changes in its communication facilities, equipment, operations, or procedures where such action is reasonably required in the operation of its business and is not inconsistent with the rules and regulations of the Federal Communications Commission. **Do not attempt to repair or modify this equipment.**

WARNING: Changes or modifications not expressly approved by the party responsible for its compliance could void the user's authority to operate the equipment.

Some cordless telephones operate at frequencies that may cause interference to nearby TVs and VCRs. To minimize or prevent such interference, the **BASE UNIT** of the cordless telephone should not be placed on or near a TV or VCR. If interference is experienced, moving the cordless telephone farther away from the TV or VCR will often reduce or eliminate the interference.

IMPORTANT

Placing your BASE UNIT near appliances such as televisions, refrigerators, radios, or microwave ovens may cause interference.

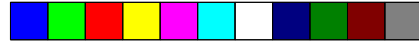

FCC Requirements



Federal Communications Commission Requirements (continued)

This equipment should not be used on coin telephone lines. Connection to party line service is subject to state tariffs. If trouble is experienced, disconnect this equipment from the telephone line to determine if it is causing the malfunction. If the equipment is determined to be malfunctioning, its use should be discontinued until the problem has been corrected.

NOTE: This equipment has been tested and found to comply with the limits for a class B digital device, pursuant to Part 15 of the FCC Rules. These limits are designed to provide reasonable protection against harmful interference in a residential installation. This equipment generates, uses, and can radiate radio frequency energy and, if not installed and used in accordance with the instructions, may cause harmful interference to radio communications.

However, there is no guarantee that interference will occur in a particular installation. If this equipment does cause harmful interference to radio or television reception, which can be determined by turning the equipment off and on, the user is encouraged to try to correct the interference by one or more of the following measures.

1. Reorient or relocate the receiving ANTENNA.
2. Increase the distance between the equipment and the receiver.
3. Connect the equipment into an outlet on a circuit different from that to which the receiver is connected.
4. Consult the dealer or an experienced radio/TV technician for help.

This device complies with Part 15 of the FCC Rules. Operation is subject to the following two conditions: (1) this device may not cause harmful interference, and (2) this device must accept any interference received, including interference that may cause undesired operation.

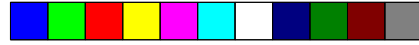

Warranty

Warranty Information

BellSouth Products

One-Year Limited Warranty

This limited warranty sets forth all **BellSouth Products** responsibilities regarding your product. There are no other expressed or implied warranties from **BellSouth Products**.

Warranty Service Provided

If you purchased the telephone new from a retail vendor, **BellSouth Products** warrants the telephone against defects in material and workmanship for a period of one (1) year from the original date of purchase. This warranty is in lieu of all other expressed warranties. This warranty begins when you purchase the telephone and continues for one (1) year unless you sell or rent the telephone, in which case the warranty stops.

BellSouth Products disclaims any implied warranty, including the warranty of merchantability and the warranty of fitness for a particular purpose, as of the date of 90 days from your original purchase of the telephone. **BellSouth Products** assumes no responsibility for any special, incidental, or consequential damages.

This warranty gives you specific legal rights and you may have other rights which vary from state to state. Some states do not allow the exclusion or limitations of special, incidental or consequential damages, or limitations on how long a warranty lasts, so the above exclusion and limitation may not apply to you.

Warranty Service Not Provided

This warranty does not cover damage resulting from accident, misuse, abuse, improper installation or operation, lack of reasonable care, unauthorized modification, the affixing of any attachment not provided by **BellSouth Products** with the telephone and/or loss of parts. This warranty is voided in the event any unauthorized person opens, alters or repairs the telephone. All **BellSouth** equipment being returned for repair must be suitably packaged. Telephone companies use different types of equipment and offer various types of services to customers. **BellSouth Products** does not warrant that this telephone is compatible with the type of equipment of any particular telephone company or the services provided by it.

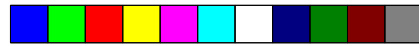

Warranty

What to Do for Warranty Service

During the first thirty (30) days, a defective product is eligible for over-the-counter exchange at the retailer from whom it was purchased. After thirty (30) days, the defective product should be returned to the authorized service center. Please allow 2-3 weeks for the return of your telephone product. The shipping address of the authorized service center is:

U.S. Electronics CONSUMER CENTER
C/O Southern Bonded Warehouse
7137 Southlake Parkway
Morrow, GA 30260

NOTE: A product received which was not made for **BellSouth Products** or which is not defective as determined by our test procedures will not be repaired and will be returned C.O.D., freight.

To Obtain Warranty Service

- Provide proof of the date of purchase within the package.
- Prepay all shipping costs to the authorized service center.
- Include a return shipping address within the package.

Please retain your sales receipt, the carton, the packing materials, and the printed material. The original carton is the best shipping container for the telephone should you have to return it.

For your reference:

Serial number _____

Date of Purchase _____

Name of Dealer _____

Visit Us on the Web
www.uselectronics.info

Customer Service Telephone Number:

1-800-210-8950

OUTSIDE THE U.S.A. CALL 1-212-242-6978

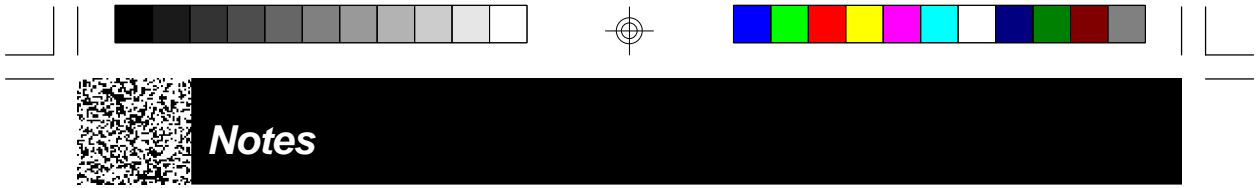

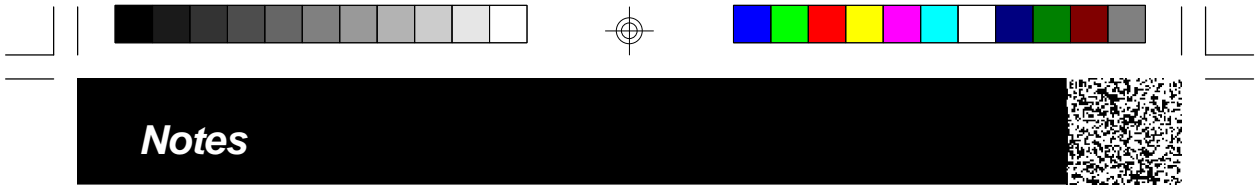

Notes



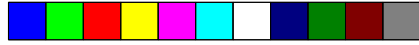

Wall Mount Template

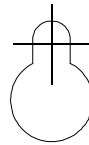

This page serves as a template for attachment of screws to the wall when mounting this telephone on the wall.

1. Cut out this page.
2. Use this template to determine the distance between screws when mounting this phone on the wall. The two cross hairs identify where to attach the screws.

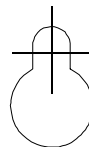

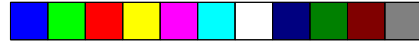

IMPORTANT

In order to get maximum life from the **HANDSET BATTERY PACK**, be sure to charge the **HANDSET** for 12 hours before initial use.

IMPORTANT

Placing your **BASE UNIT** near appliances such as televisions, refrigerators, radios, or microwave ovens may cause interference.

IMPORTANT

When you hear interference, press the **DEL/CHAN** button to change the operating channel.

IMPORTANT

The **AC ADAPTOR** must always be plugged into an electrical outlet.

IMPORTANT

In order to utilize the **Caller ID** feature, you must subscribe to **Caller ID** service from your local telephone company.

IMPORTANT

If you live in an area which receives frequent thunderstorms, we strongly recommend plugging your **AC ADAPTOR** into a surge protector.

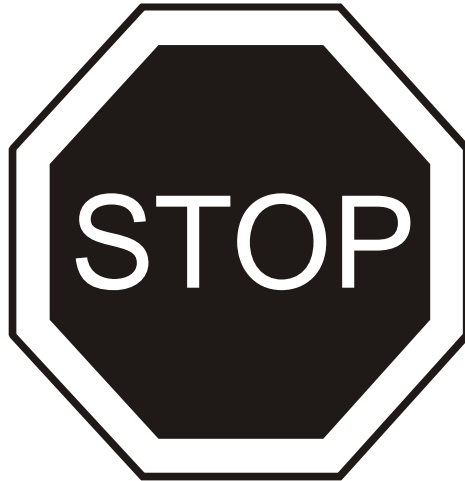
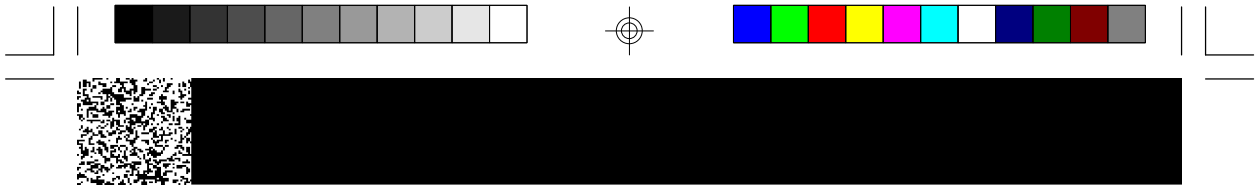

**Make certain you receive the best
performance from your telephone.
Read this manual first.**



**Visit Us on the Web
www.uselectronics.info**

MH9915
XXX

Made in China
LD