

TEC

TEC Thermal Printer

B-450-QQ SERIES

Owner's Manual



TOSHIBA TEC CORPORATION

Safety Summary

Personal safety in handling or maintaining the equipment is extremely important. Warnings and Cautions necessary for safe handling are included in this manual. All warnings and cautions contained in this manual should be read and understood before handling or maintaining the equipment. Do not attempt to effect repairs or modifications to this equipment. If a fault occurs that cannot be rectified using the procedures described in this manual, turn off the power, unplug the machine, then contact your authorized TOSHIBA TEC representative for assistance.

Meanings of Each Symbol



This symbol indicates warning items (including cautions). Specific warning contents are drawn inside the \triangle symbol. (The symbol on the left indicates a general caution.)



This symbol indicates prohibited actions (prohibited items). Specific prohibited contents are drawn inside or near the \circ symbol. (The symbol on the left indicates "no disassembling".)



This symbol indicates actions which must be performed. Specific instructions are drawn inside or near the \bullet symbol. (The symbol on the left indicates "disconnect the power cord plug from the outlet".)



WARNING

This indicates that there is the risk of **death** or **serious injury** if the machines are improperly handled contrary to this indication.



Any other than the specified AC voltage is prohibited.

■ Do not use voltages other than the voltage (AC) specified on the rating plate, as this may cause **fire** or **electric shock**.

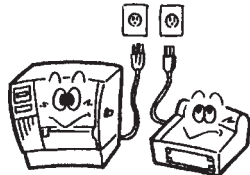

Prohibited

■ Do not plug in or unplug the power cord plug with wet hands as this may cause **electric shock**.

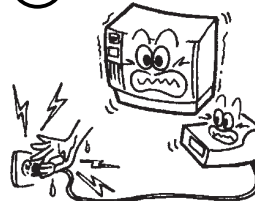

Prohibited

■ If the machines share the same outlet with any other electrical appliances which consume large amounts of power, the voltage will fluctuate widely each time these appliances operate. Be sure to provide an exclusive outlet for the machine as this may cause the machines to **malfunction**.



Prohibited

■ Do not place metal objects or water-filled containers such as flower vases, flower pots or mugs, etc. on top of the machines. If metal objects or spilled liquid enter the machines, this may cause **fire** or **electric shock**.

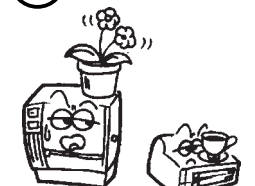

Prohibited

■ Do not insert or drop metal, flammable or other foreign objects into the machines through the ventilation slits, as this may cause **fire** or **electric shock**.

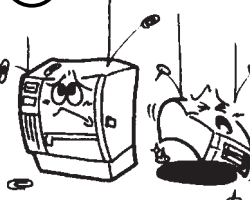

Prohibited

■ Do not scratch, damage or modify the power cords. Also, do not place heavy objects on, pull on, or excessively bend the cords, as this may cause **fire** or **electrical shock**.

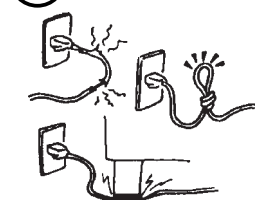

Disconnect the plug.



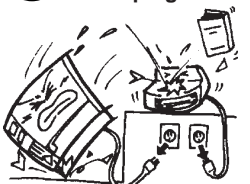



■ If the machines are dropped or their cabinets damaged, first turn off the power switches and disconnect the power cord plugs from the outlet, and then contact your authorized TOSHIBA TEC representative for assistance. Continued use of the machine in that condition may cause **fire** or **electric shock**.

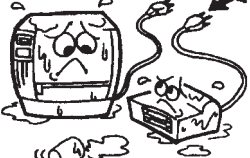

Disconnect the plug.

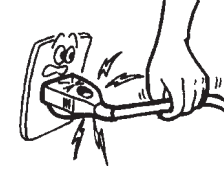
■ Continued use of the machines in an abnormal condition such as when the machines are producing smoke or strange smells may cause **fire** or **electric shock**. In these cases, immediately turn off the power switches and disconnect the power cord plugs from the outlet. Then, contact your authorized TOSHIBA TEC representative for assistance.

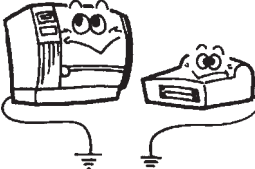

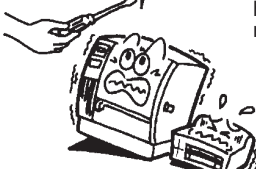
 <p>Disconnect the plug.</p>  <p>■ If foreign objects (metal fragments, water, liquids) enter the machines, first turn off the power switches and disconnect the power cord plugs from the outlet, and then contact your authorized TOSHIBA TEC representative for assistance. Continued use of the machine in that condition may cause fire or electric shock.</p>	 <p>Disconnect the plug.</p>  <p>■ When unplugging the power cords, be sure to hold and pull on the plug portion. Pulling on the cord portion may cut or expose the internal wires and cause fire or electric shock.</p>
 <p>Connect a grounding wire.</p>  <p>■ Ensure that the equipment is properly grounded. Extension cables should also be grounded. Fire or electric shock could occur on improperly grounded equipment.</p>	 <p>No disassembling.</p>  <p>■ Do not remove covers, repair or modify the machine by yourself. You may be injured by high voltage, very hot parts or sharp edges inside the machine.</p>



CAUTION This indicates that there is the risk of personal **Injury** or **damage** to objects if the machines are improperly handled contrary to this indication.

Precautions

The following precautions will help to ensure that this machine will continue to function correctly.

- Try to avoid locations that have the following adverse conditions:

* Temperatures out of the specification	* Direct sunlight	* High humidity
* Shared power source	* Excessive vibration	* Dust/Gas
- The cover should be cleaned by wiping with a dry cloth or a cloth slightly dampened with a mild detergent solution. NEVER USE THINNER OR ANY OTHER VOLATILE SOLVENT on the plastic covers.
- USE ONLY TOSHIBA TEC SPECIFIED paper and ribbons.
- DO NOT STORE the paper or ribbons where they might be exposed to direct sunlight, high temperatures, high humidity, dust, or gas.
- Ensure the printer is operated on a level surface.
- Any data stored in the memory of the printer could be lost during a printer fault.
- Try to avoid using this equipment on the same power supply as high voltage equipment or equipment likely to cause mains interference.
- Unplug the machine whenever you are working inside it or cleaning it.
- Keep your work environment static free.
- Do not place heavy objects on top of the machines, as these items may become unbalanced and fall causing **injury**.
- Do not block the ventilation slits of the machines, as this will cause heat to build up inside the machines and may cause **fire**.
- Do not lean against the machine. It may fall on you and could cause **injury**.
- Care must be taken not to injure yourself with the printer paper cutter.
- Unplug the machine when it is not used for a long period of time.

Request Regarding Maintenance

- Utilize our maintenance services.
After purchasing the machine, contact your authorized TOSHIBA TEC representative for assistance once a year to have the inside of the machine cleaned. Otherwise, dust will build up inside the machines and may cause a **fire** or a **malfunction**. Cleaning is particularly effective before humid rainy seasons.
- Our preventive maintenance service performs the periodic checks and other work required to maintain the quality and performance of the machines, preventing accidents beforehand. For details, please consult your authorized TOSHIBA TEC representative for assistance.
- Using insecticides and other chemicals
Do not expose the machines to insecticides or other volatile solvents. This will cause the cabinet or other parts to deteriorate or cause the paint to peel.

TABLE OF CONTENTS

	Page
1. INTRODUCTION	1- 1
1.1 APPLICABLE MODEL	1- 1
1.2 ACCESSORIES	1- 1
2. SPECIFICATIONS	2- 1
2.1 GENERAL SPECIFICATIONS	2- 1
2.2 PRINTING SPECIFICATIONS	2- 1
2.3 PAPER (LABEL/TAG) SPECIFICATIONS	2- 2
2.4 RIBBON SPECIFICATIONS	2- 2
2.5 OPTION	2- 2
3. APPEARANCE	3- 1
3.1 FRONT/REAR VIEW	3- 1
3.2 OPERATION PANEL	3- 1
4. DIP SWITCH FUNCTIONS	4- 1
5. SETUP PROCEDURE	5- 1
5.1 REQUIREMENTS FOR OPERATION	5- 1
5.2 SETTING UP THE PRINTER	5- 1
6. INSTALLATION PROCEDURE	6- 1
6.1 INSTALLING THE SUPPLY HOLDER UNIT	6- 1
6.2 CONNECTING THE POWER CORD AND CABLES	6- 1
7. LOADING THE RIBBON	7- 1
8. LOADING THE PAPER	8- 1
9. THRESHOLD SETTING	9- 1
10. CARE/HANDLING OF THE PAPER AND RIBBON	10- 1
11. GENERAL MAINTENANCE	11- 1
11.1 CLEANING	11- 1
11.2 COVERS	11- 2
11.3 REMOVING JAMMED PAPER	11- 3
12. TROUBLESHOOTING	12- 1
APPENDIX	13- 1
INDEX	

This equipment has been tested and found to comply with the limits for a Class A digital device, pursuant to Part 15 of the FCC Rules. These limits are designed to provide reasonable protection against harmful interference when the equipment is operated in a commercial environment. This equipment generates, uses, and can radiate radio frequency energy and, if not installed and used in accordance with the instruction manual, may cause harmful interference to radio communications.

Operations of this equipment in a residential area is likely to cause harmful interference in which case the user will be required to correct the interference at his own expense. (for USA only)

Changes or modifications not expressly approved by manufacturer for compliance could void the user's authority to operate the equipment.

"This Class A digital apparatus meets all requirements of the Canadian Interference-Causing Equipment Regulations."

"Cet appareil numérique de la classe A respecte toutes les exigences du Règlement sur le matériel brouilleur de Canada."

(for CANADA only)

CAUTION:

1. *This manual may not be copied in whole or in part without prior written permission of TOSHIBA TEC.*
2. *The contents of this manual may be changed without notification.*
3. *Please refer to your local Authorized Service representative with regard to any queries you may have in this manual.*

1. INTRODUCTION

Thank you for choosing the TEC B-450 Series thermal/transfer printer. This new generation high performance high quality printer is equipped with the latest hardware including the newly developed high density (11.8 dot/mm, 300 dot/inch) print head. This allows very clear print at a maximum speed of 101.6 mm/sec. (4 inch/sec.). Other standard features include an external paper supply. Optional features include a strip mechanism and cutter mechanism. This manual contains general set-up and maintenance information and should be read carefully to help gain maximum performance and life from your printer. For most queries please refer to this manual and keep it safe for future reference.

1.1 APPLICABLE MODEL

- B-452-TS10-QQ
Model name description

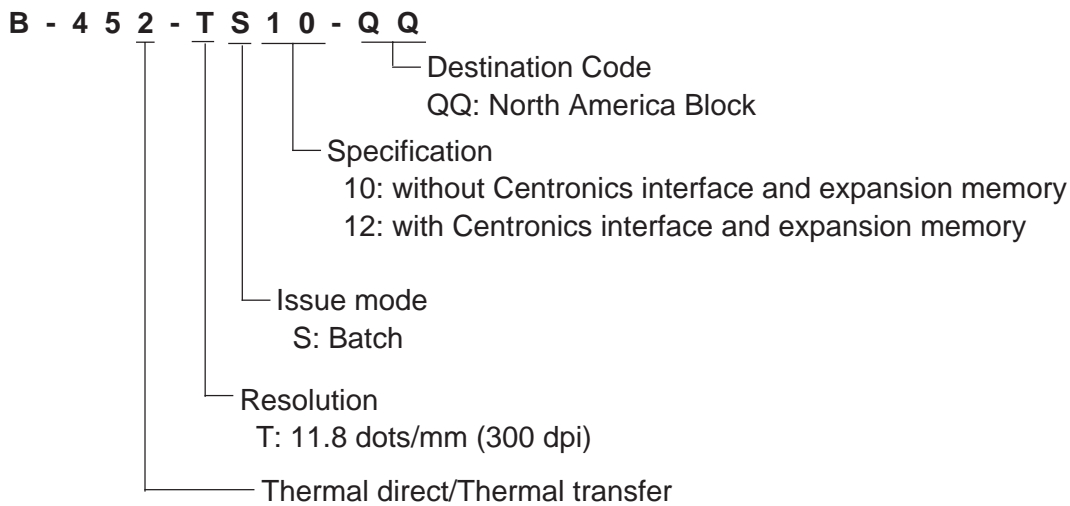

1.2 ACCESSORIES

Owner's Manual
(EO1-33006)



Power Cord

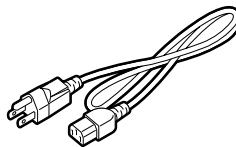

Supply Holder



Spacer



Supply Holder Unit



2. SPECIFICATIONS

2.1 GENERAL SPECIFICATIONS

Item \ Model	B-452-TS10-QQ
Supply voltage	100 ~ 120V, 60Hz
Power consumption	0.94 A, 47 W maximum (standby: 0.3 A, 18 W maximum)
Operating temperature	5°C ~ 40°C
Relative humidity	25% ~ 85%RH (no condensation)
Dimensions	270 mm (width) x 245 mm (height) x 200 mm (depth), with Supply holder unit 410 mm (depth)
Weight	4.7 kg (without paper and ribbon)

2.2 PRINTING SPECIFICATIONS

Item \ Model	B-452-TS10-QQ
Print head	Thermal print head 11.8 dots per mm (300 dots per inch)
Printing methods	Direct thermal or Thermal transfer
Print speeds	50.8 mm/sec. (2 inch/sec.) for serial barcodes and two-dimensional codes, 101.6 mm/sec. (4 inch/sec.)
Maximum print width	105.7 mm (4.16 inches)
Dispensing modes	Batch (Continuous), Strip (Option) and Cut modes (Option) (Both cut and strip modes are available only when their respective modules are fitted.)
Available bar-code types	JAN8, JAN13, EAN8, EAN8 + 2 digits, EAN8 + 5 digits EAN13, EAN13 + 2digits, EAN13 + 5 digits UPC-E, UPC-E + 2 digits, UPC-E + 5 digits UPC-A, UPC-A + 2 digits, UPC-A + 5 digits MSI, ITF, NW-7, CODE39, CODE93, CODE128 Industrial 2 to 5, UCC/EAN128, Customer bar code, POSTNET RM4SCC, KIX code
Two-dimensional code	Data Matrix, PDF417, QR code, Maxi code
Graphics	All types of graphic files are available when using the windows driver. However, only BMP and PCX files are available when using the programming commands.
Fonts	Times Roman (6 sizes), Helvetica (6 sizes), Presentation (1 size), Letter Gothic (1 size), Prestige Elite (2 sizes), Courier (2 sizes), OCR (2 types), Writable characters, Outline font (7 type)
Rotations	0°, 90°, 180°, 270°
Standard interfaces	Serial interface (RS-232C) Parallel interface (Centronics) QP only Optional keyboard interface

* Data Matrix™ is a trademark of International Data Matrix, Inc.
PDF417 is a trademark of Symbol Technologies, Inc.
QR code is a trademark of DENSO CORPORATION.
Maxi code is a trademark of United Parcel Service of America, Inc.

2.3 PAPER (LABEL/TAG) SPECIFICATIONS

[Unit: mm]

Item	Label dispensing mode		
	Batch mode	Strip mode	Cut mode
Span of one label/tag	15.0 ~ 999.0	25.4 ~ 999.0	Label: 37.0 ~ 999.0 Tag: 25.4 ~ 999.0
Label length	13.0 ~ 997.0	23.4 ~ 997.0	31.0 ~ 993.0
Width including backing paper	25.4 ~ 114.0		
Label width	22.4 ~ 111.0		
Gap length	2.0 ~ 20.0	2.0 ~ 20.0	6.0 ~ 20.0
Black mark length (Tag paper)	2.0 ~ 20.0		
Effective print width	10.0 ~ 105.7		
Effective print length	Label	15.0 ~ 500.0	
	Tag	15.0 ~ 500.0	
Print speed up/slow down area	1.0		
Black mark length (Label)	MIN. 2.0		
Outer roll diameter	MAX. \varnothing 150 (Paper Core \varnothing 38, 40, 42 or 76.2)		
Thickness	0.1 ~ 0.17	0.13 ~ 0.17	0.1 ~ 0.17

2.4 RIBBON SPECIFICATINS

Type	Spool type
Width	60 mm ~ 110 mm
Length	(300 m)
Outer diameter	\varnothing 65 mm (max.)

- NOTES:**
1. To ensure good print quality and maximum print head life use only TOSHIBA TEC specified paper and ribbons.
 2. For further information about paper and ribbon, refer to Section 10. CARE/HANDLING OF THE PAPER AND RIBBON.

2.5 OPTION

Option Name	Type	Description
Cutter module	B-7204-QM	A stop-and-cut rotary cutter
Strip module	B-7904-H-QM	This module strips the label from the backing paper with the take-up block and strip block.
Keyboard module	KB-80-QM	This module is an external intelligent keyboard unit.
Expansion I/O interface board	B-7704-IO-QM	Installing this board in the printer allows a connection with an external device with the exclusive interface, such as the keyboard module.
Centronics interface board	B-7704-C-QM	Installing this board in the printer allows parallel connection from the PC via the Centronics interface.
Expansion memory board (1M byte)	B-7804-E1M-QM	A 1MB flash memory which stores trun type fonts and writable characters.

3. APPEARANCE

3.1 FRONT/REAR VIEW

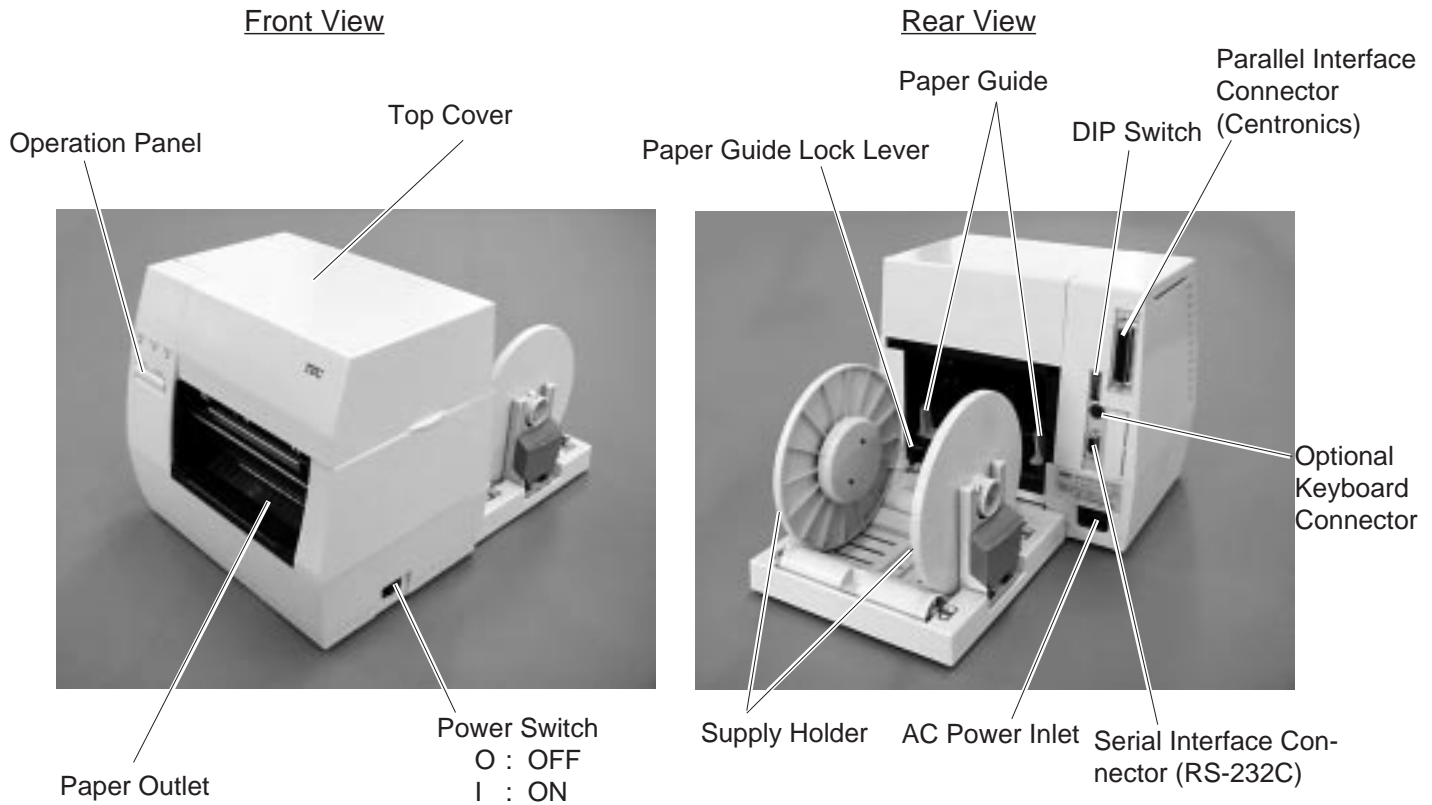

Fig. 3-1

3.2 OPERATION PANEL



Fig. 3-2

POWER LED (Green)

Lights when the power is turned on.

ON-LINE LED (Green)

- 1) Flashes when communicating with a host computer.
- 2) On while printing.

ERROR LED (Red)

Lights when a communication error occurs, when the paper/ribbon ends or the printer is not operating correctly.

FEED Key

Feeds paper.

PAUSE Key

Pauses printing.
Resets the printer when paused or when an error occurs.

4. DIP SWITCH FUNCTIONS

The DIP switches are located at the rear of the printer.

WARNING!

Turn the **POWER OFF** before switching the functions.

DIP SW



Fig. 4-1

DIP SW

No.	ON/OFF		Function	Remarks
	1	2		
1	OFF	OFF	2400 bps	Transmission speed (Baud rate)
	ON	OFF	4800 bps	
2	OFF	ON	9600 bps	
	ON	ON	19200 bps	
3	OFF		None	Parity
	ON		EVEN	
4	OFF		Not available	Stacker
	ON		Available	
5	OFF		Available	Auto media feed
	ON		Not available	
6	6	7	RAM clear mode (Maintenance counter)	Selectable only when DIP SW #8 is ON.
	ON	OFF	Threshold manual setting mode	
7	OFF	ON	Sensor adjustment mode	Operating mode
	ON	ON	RAM clear mode (Parameter)	
8	OFF		Normal operation mode	
	ON		Program down load operation	

- NOTES:**
1. DIP Switch settings are read at power on time.
 2. To enter the program download mode first set DIP SW #8 to ON. The printer will then enter the relevant modes, as selected by DIP SWS #6 and #7. To initialise these modes hold down the **[FEED]** or **[FEED]** and **[PAUSE]** keys whilst turning the power on. If the printer is turned on without pressing a key, it will enter the program down load mode. Do not set the switches to the maintenance mode as this may cause a failure.

5. SET UP PROCEDURE

5.1 REQUIREMENTS FOR OPERATION

This machine has the following requirements:

- The host computer must have a serial port or centronics parallel port.
- To communicate with host, either an RS-232C cable or Centronics cable is required.
 - (1) RS-232C cable 9 pins
 - (2) Centronics cable 36 pins
- To print a label format, create the complete program using the interface/communication manual.

■ Interface Cables

To prevent radiation and reception of electrical noise, the interface cables must meet the following requirements:

- Fully shielded and fitted with metal or metalized connector housings.
- Kept as short as possible.
- Should not be bundled tightly with power cords.
- Should not be tied to power line conduits.

■ RS-232C Cable description

The serial data cable used to connect the printer to the host computer should be one of the following two types:

NOTE: Use the RS-232C cable which connector securing screws are inch type.

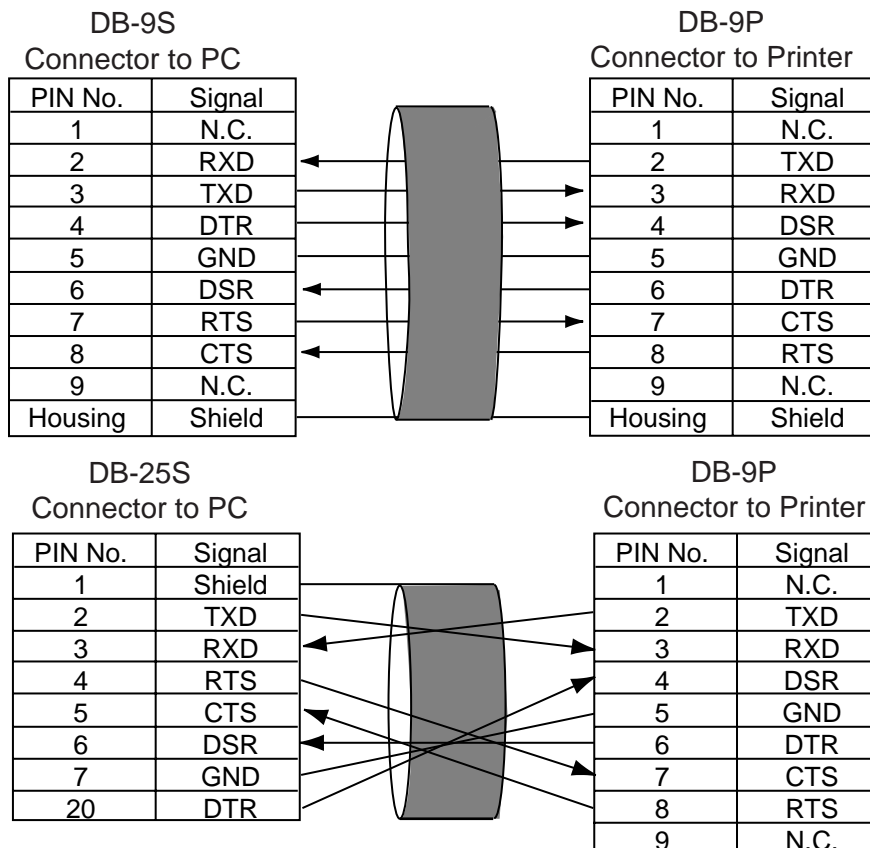

Fig. 5-1

5.2 SETTING UP THE PRINTER

- Place the printer on a flat, stable surface.
- Use a grounded electrical outlet do not use adapter plug.
- Be sure there is adequate room around the printer for easy operation and maintenance.
- Keep your work environment static free.

6. INSTALLATION PROCEDURE

6.1 INSTALLING THE SUPPLY HOLDER UNIT

WARNING!
Turn the power OFF before installing the supply holder unit.

Fit the two studs on the bottom of the printer into the holes in the supply holder unit.

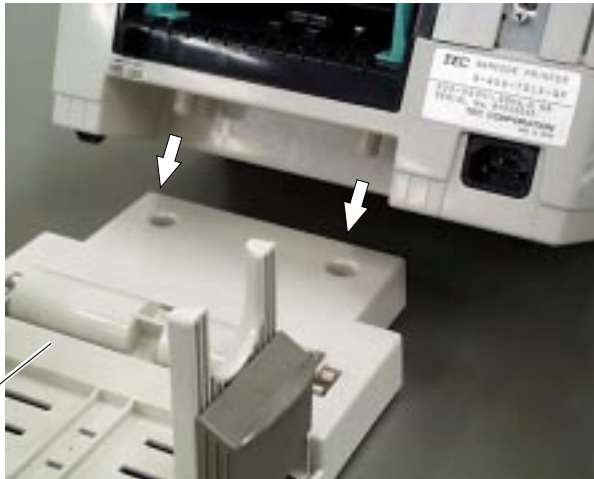

Supply Holder Unit

Fig. 6-1

6.2 CONNECTING THE POWER CORD AND CABLES

WARNING!
*Turn the **POWER SWITCH** to OFF before connecting the power cord or cables.*

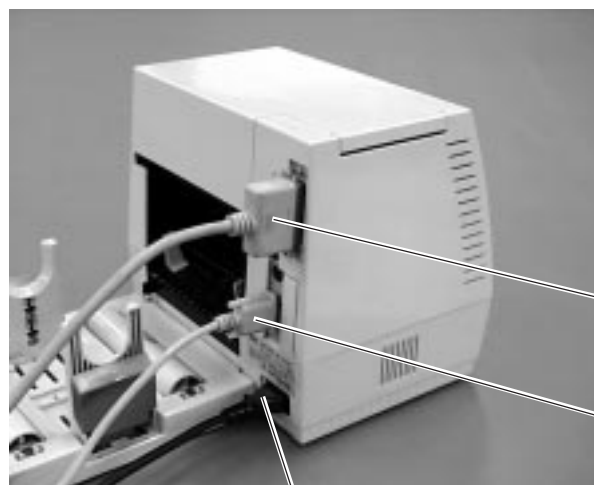

Parallel Interface Cable
(Centronics)

Serial Interface Cable
(RS-232C)

Power Cord

Fig. 6-2

7. LOADING THE RIBBON

The printer is capable of printing in both direct thermal and thermal transfer modes.

DO NOT LOAD a ribbon when using a direct thermal paper.

1. Turn the power off and open the top cover.
2. Move the head release lever toward the front of the printer and raise the print head block.

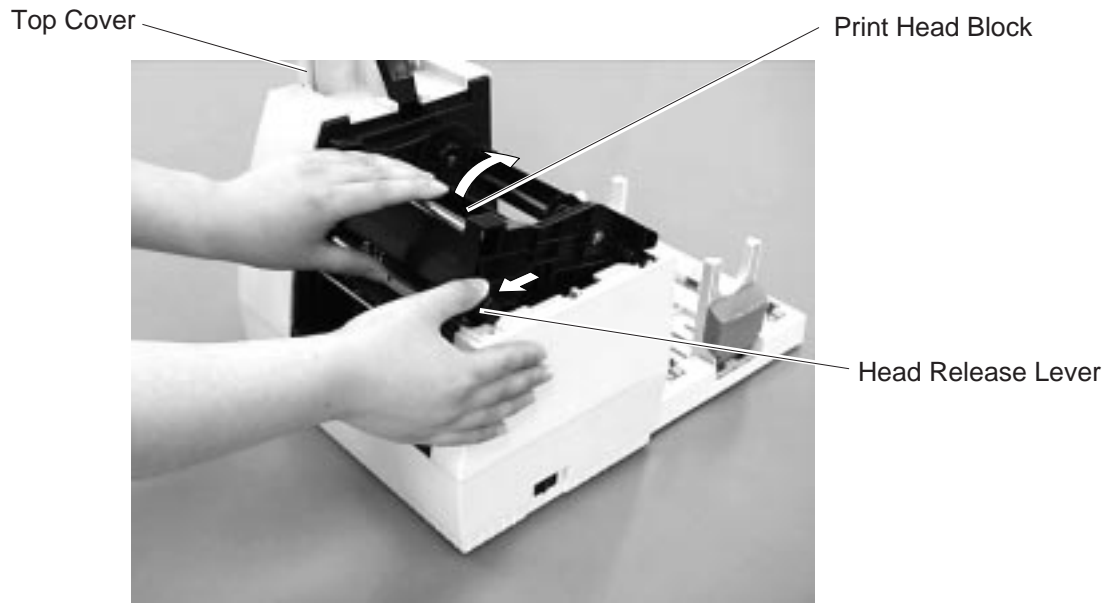

Fig. 7-1

3. Fit the protrusion of the guide wheel into the notch of the ribbon core (take-up side).
4. Pull the knob and set the ribbon core to the spring guide wheel.

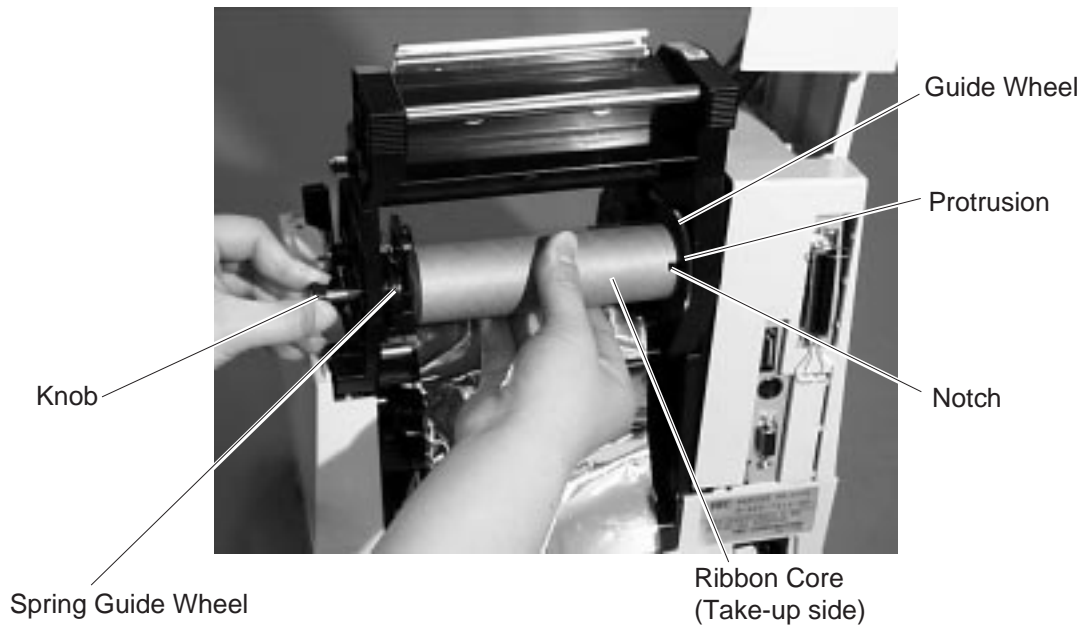

Fig. 7-2

5. Set the ribbon core (supply side) by fitting the protrusion into the notch.

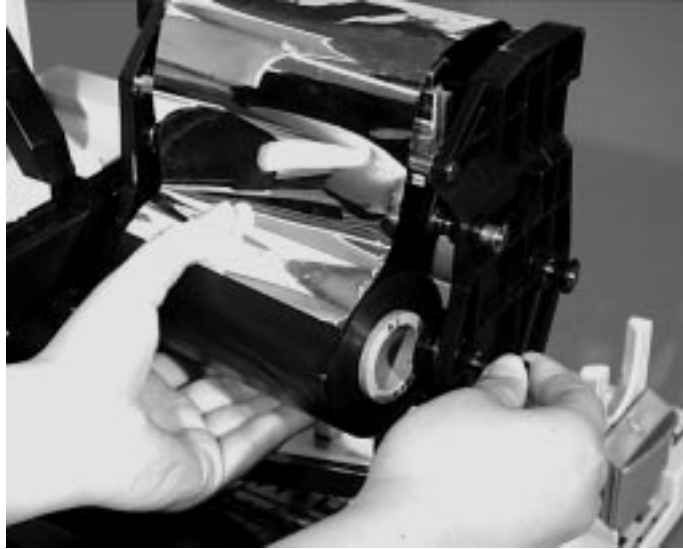

Fig. 7-3

6. Turn the guide wheel in the arrow-indicating direction to remove any slack of the ribbon.

NOTE: Make sure that the ribbon has no wrinkles and the protrusions are fitted into the notches of the ribbon cores.

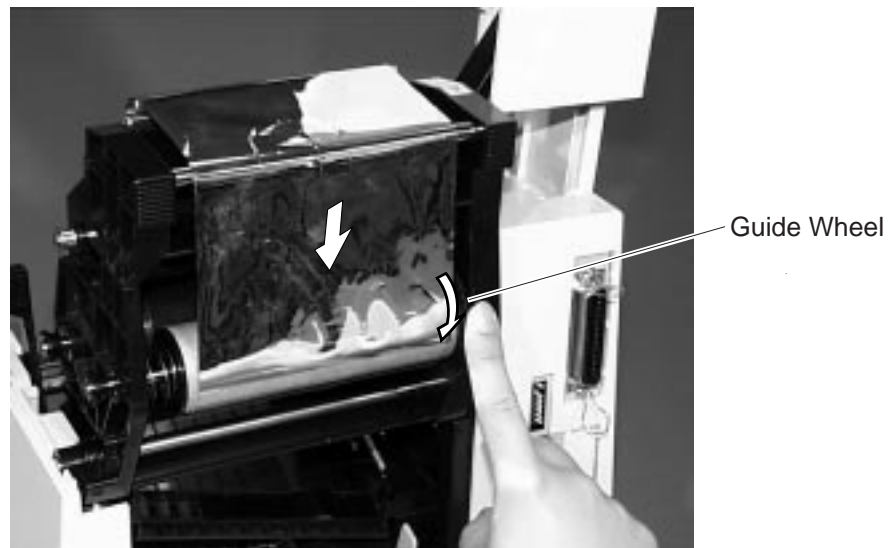

Fig. 7-4

8. LOADING THE PAPER

This supply holder accepts four sizes of label core: 38 mm, 40 mm, 42 mm and 76.2 mm. When using a paper roll of 38 mm, 40 mm or 42 mm, remove the spacers from the supply holders using the following procedure.

1. Push both hooks of the spacer to remove it from the supply holder. Keep the removed spacers safe.

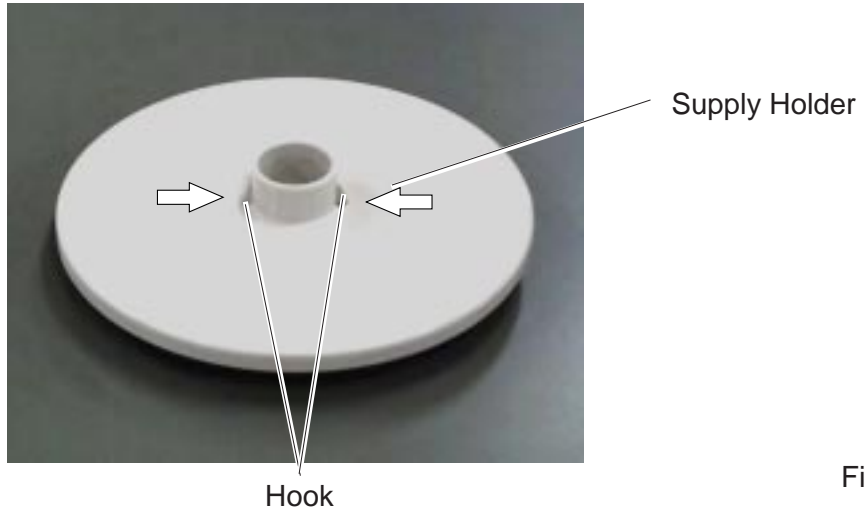

Fig. 8-1

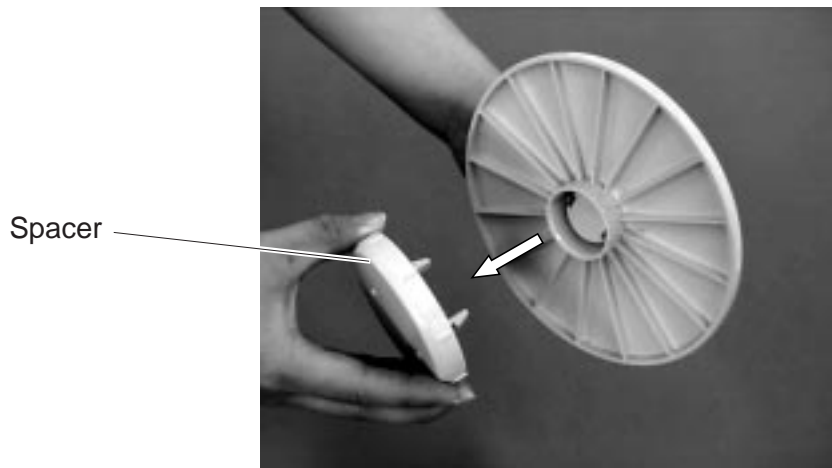

Fig. 8-2

2. Set the supply holders to both sides of the paper roll.

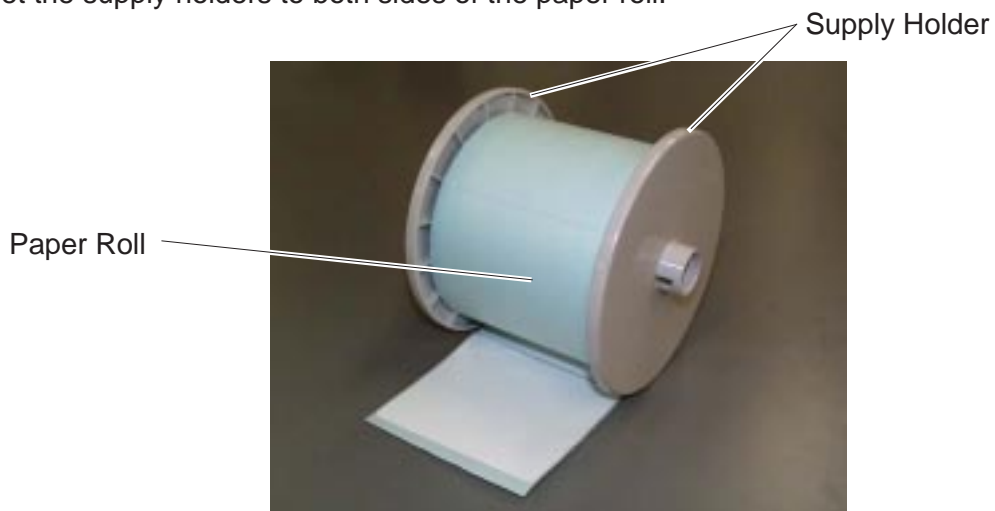

Fig. 8-3

3. Put the paper roll and supply holders on the supply holder unit.

NOTE: Paper may be wound outside or inside. Regardless of the paper roll, the paper must be loaded so that the print side faces upward.

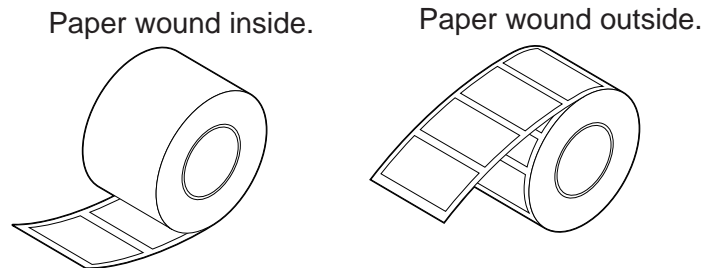

Fig. 8-4

4. Push both sides of the supply holder guides against the paper roll, then lock them with the lock lever.

NOTE: Make sure that the supply holders rotate slightly.

5. Pass the paper through the printer until it is past the paper outlet.

6. Adjust the position of the paper guides to the paper width, then lock them with the lock lever.

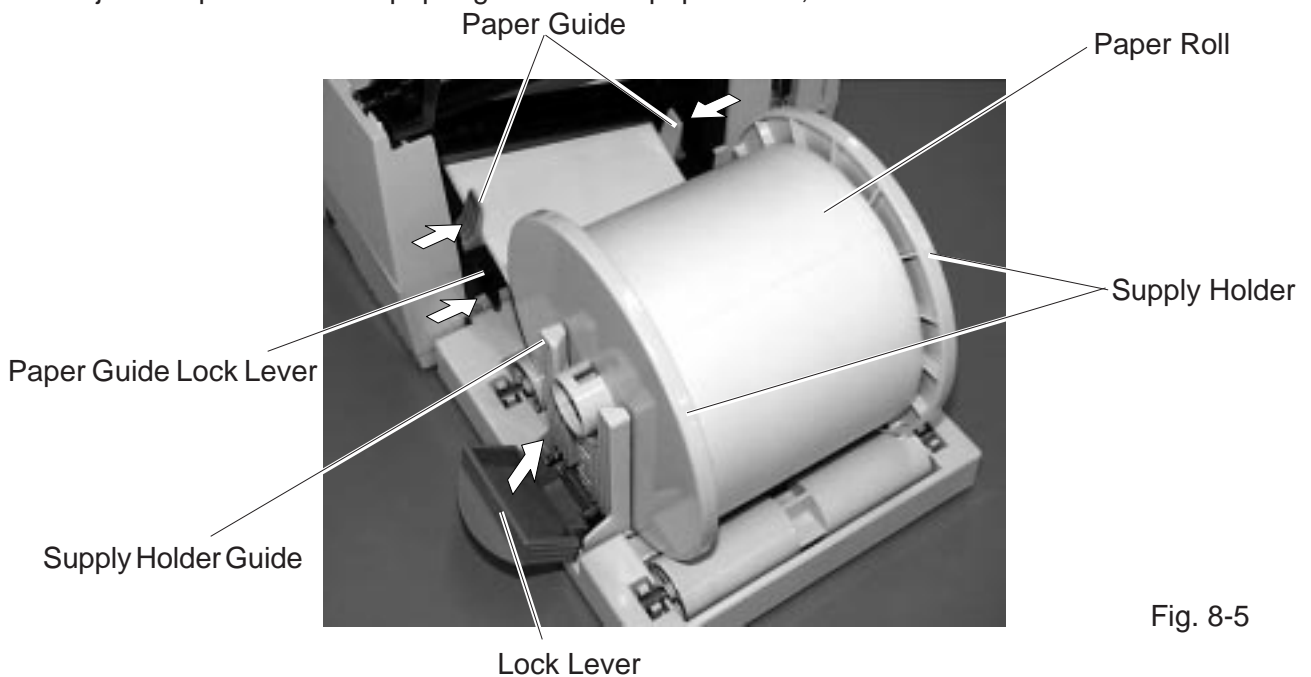

Fig. 8-5

7. Close the print head block by pressing both sides of the print head block's top until it clicks.



Fig. 8-6

NOTE: Pass the paper straight from the supply holder to paper outlet. Failure to do this may cause skew feeding or paper jam.

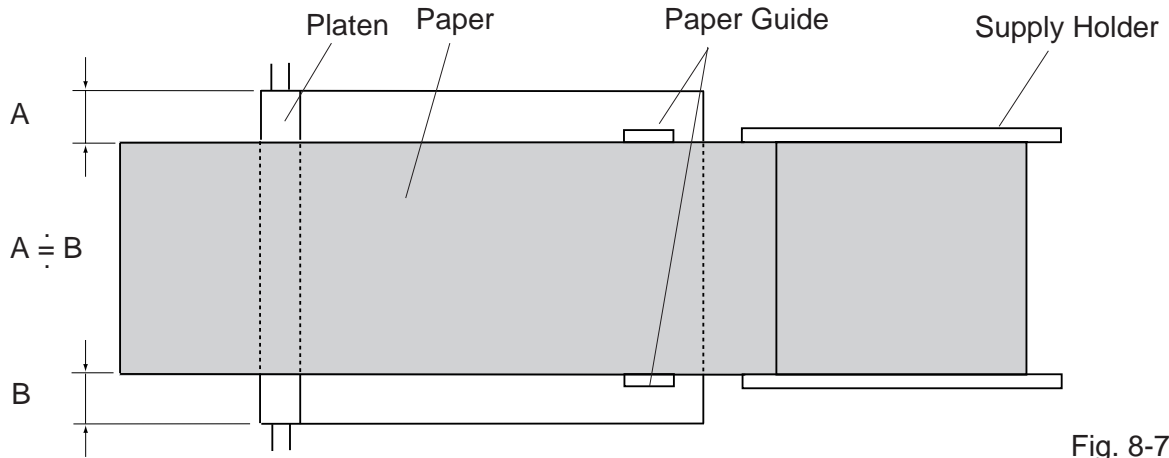

Fig. 8-7

8. Close the top cover. Paper loading is now completed.

Batch type:

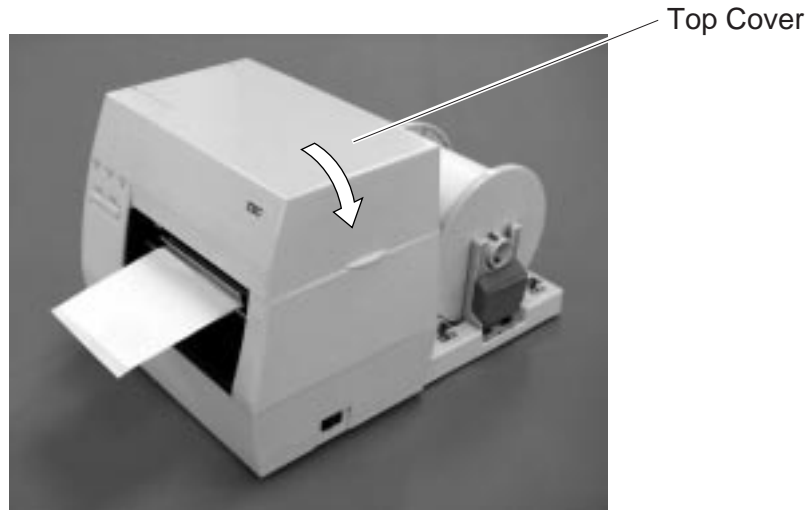

Fig. 8-8

Cutter type: Where a cutter is fitted load the paper as standard and feed it through the cutter module.

NOTES: 1. When using the cutter, be sure to cut the backing paper between the labels. Cutting on the label will cause the glue to stick to the cutter, which may affect the cutter quality and shorten its life.

2. Use of tag paper that exceeds the specified thickness may affect the cutter life.

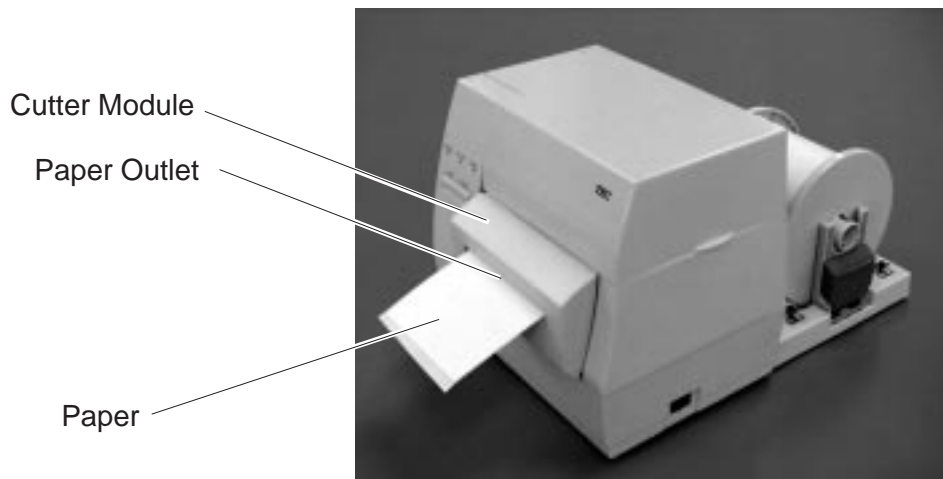
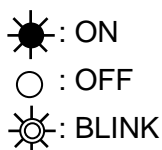
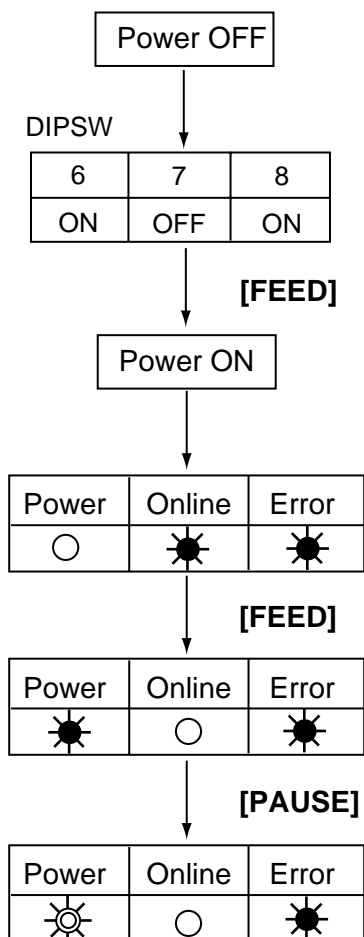

Fig. 8-9

9. THRESHOLD SETTING

For the printer to maintain a constant print position it uses the transmissive sensor to measure the amount of light passing through the gap between labels. When the paper is pre-printed, the darker (or more dense) inks can interfere with this process causing paper jam errors. To eliminate this problem a minimum threshold can be set for the sensor in the following way.



- (1) The power is off.
- (2) Set the DIP switches to enter the manual threshold setting mode.
- (3) Turn the power ON while pressing and holding the **[FEED]** key.

The transmissive sensor is selected.

- (4) Press the **[FEED]** key.
The reflective sensor is selected.
The sensor type is switched by pressing the **[FEED]** key. Load the pre-printed label roll in the usual way.
- (5) Press and hold the **[PAUSE]** key.
The paper will feed through the printer until the **[PAUSE]** key is released. Release the **[PAUSE]** key after more than 1.5 labels have been fed. (Threshold setting is completed by this operation.)
- (6) Turn the power OFF.

- NOTES:**
1. To set the threshold properly, be sure to feed more than 1.5 labels. Insufficient paper feeding may result in an incorrect threshold setting. In this case, repeat the procedure.
 2. While the print head is raised, the **[PAUSE]** key does not work.
 3. If the paper runs out or a cutter error occurs, it will not be detected during the paper feed.
 4. If the printer does not print in the correct position even after the threshold setting, the transmissive sensor adjustment may be wrong. In this case, re-adjust the transmissive sensor, and then set the threshold again. (When the backing paper is thick, the transmissive sensor adjustment is required.)

10. CARE/HANDLING OF THE PAPER AND RIBBON

CAUTION:

Be sure to read carefully and understand the Supply Manual. Ask your nearest authorized TOSHIBA TEC representative for the Supply Manual. Use only paper and ribbon which meet specified requirements. Use of non-specified paper and ribbon may shorten the head life and result in problems with bar code readability or print quality. All paper and ribbon should be handled with care to avoid any damage to the paper, ribbon or printer. Read the following guideline carefully.

- Do not store the paper and ribbon for longer than the manufactures recommended shelf life.
- Store paper rolls on the flat end, do not store them on the curved sides as this might flatten that side causing erratic media advance and poor print quality.
- Store the paper in plastic bags and always reseal after opening. Unprotected paper can get dirty and the extra abrasion from the dust and dirt particles will shorten the print head life.
- Store the paper and ribbon in a cool, dry place. Avoid areas where they would be exposed to direct sunlight, high temperature, high humidity, dust or gas.
- The thermal paper used for direct thermal printing must not have the specifications which exceed Na⁺ 800 ppm, K⁺ 250 ppm and CL⁻ 500 ppm.
- Some ink used on pre-printed labels may contain ingredients which shorten the print head's product life. Do not use labels pre-printed with ink which contain hard substances such as carbonic calcium (CaCO₃) and kaolin (Al₂O₃, 2SiO₂, 2H₂O).

For further information please contact your local distributor or your paper and ribbon manufacturer.

11. GENERAL MAINTENANCE

11.1 CLEANING

WARNING!

1. Be sure to disconnect the power cord prior to performing any maintenance.
2. DO NOT POUR WATER directly onto the printer.

CAUTION:

1. Do not use any sharp objects to clean the print head and platen. Doing so may damage them, causing poor print quality or missing dots.
2. Never use a organic solvents like thinners or venzene for cleaning. Using such solvents may discolor the covers, cause poor print quality, or printer failure.
3. Do not touch the print head element as static build-up may damage the print head.

To help retain the high quality and performance of your printer it should be regularly cleaned. The greater the usage of the printer, the more frequent the cleaning. (i.e. low usage=weekly : high usage=daily).

1. Turn the power off.
2. Open the top cover.
3. Turn the head lever to raise the print head.
4. Remove the ribbon and paper.
5. Clean the print head element with print head cleaner

NOTE: Please purchase the print head cleaner from the authorized TOSHIBA TEC service representative.



Fig. 11-1

6. Clean the platen with a cloth moistened with alcohol.
7. Remove any dust or glue from the detection area of the sensors and paper path with a soft cloth.

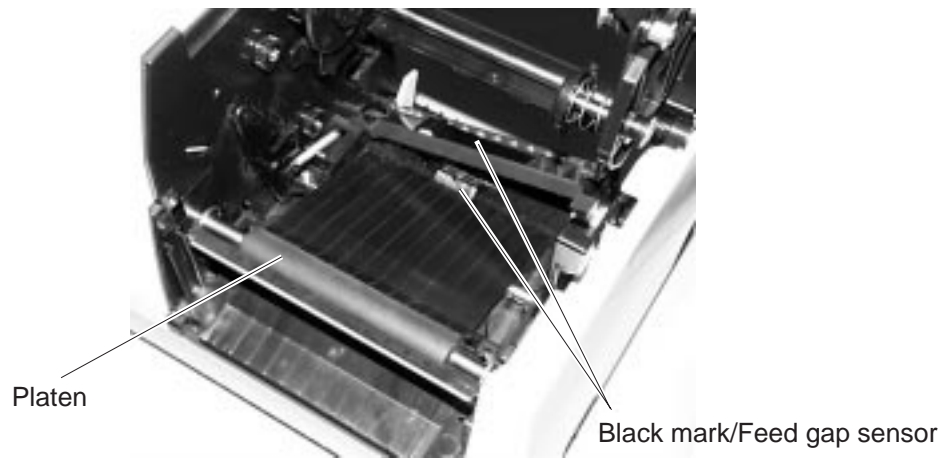

Fig. 11-2

8. Remove the supply holder rollers from the supply holder unit. Remove any dust from the recessed portions of the base and wipe glues from the rollers with a slightly moistened soft cloth.



Fig. 11-3

11.2 COVERS

The covers should be cleaned by wiping with a dry cloth or a cloth slightly dampened with a mild detergent solution.

NOTE: Clean printer cover with an electrostatic free cleaner for automated office equipment.

WARNING!

1. **DO NOT POUR WATER** directly onto the printer.
2. **DO NOT APPLY** cleaner or detergent directly onto any cover.
3. **NEVER USE THINNER OR OTHER VOLATILE SOLVENT** on the plastic covers.
4. **DO NOT** clean the covers with alcohol as it may cause them to discolor, loose their shape or develop structural weakness.

11.3 REMOVING JAMMED PAPER

1. Turn the power off.
2. Open the top cover.
3. Move the head release lever toward the front of the printer to raise the print head block.
4. Remove the ribbon and paper.
5. Remove the jammed paper. **DO NOT USE** any sharp implement or tool as these could damage the printer.
6. Clean the print head and platen, then remove any further dust or foreign substances.



Fig. 11-4

7. Paper jams in the cutter unit can be caused by wear or residual glue from label stock on the cutter. Do not use unspecified paper in the cutter. If frequent jams occur in the cutter contact your Authorized Service representative.

■ Cleaning the Cutter Unit

WARNING!

1. *Be sure to disconnect the power cord before cleaning the cutter unit.*
2. *The cutters are sharp and care should be taken not to injure yourself when cleaning.*

1. Press the cutter cover release lever to detach the cutter cover.

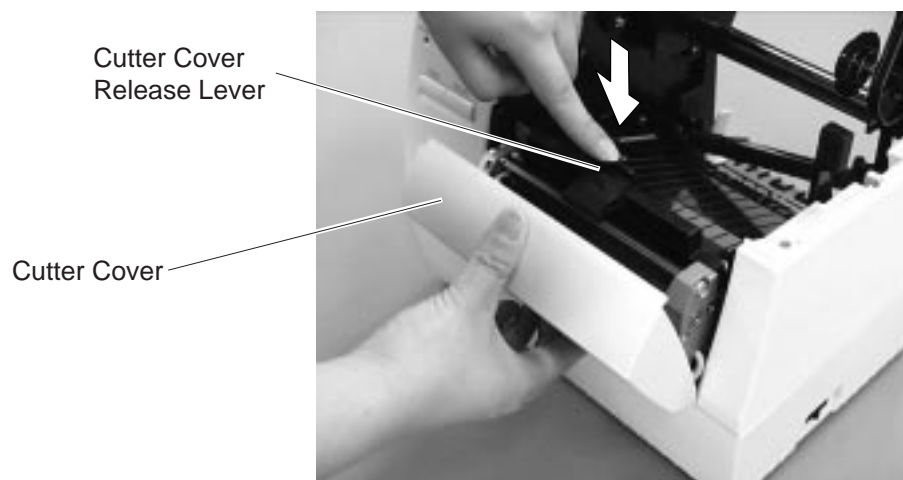

Fig. 11-5

2. Fit the enclosed Allen Key into the right side of the cutter unit to rotate the cutter manually. Remove the jammed paper and any paper particles from the cutter.
3. Clean the cutter with dry cloth.



Fig. 11-6

4. Assembling is reverse order of removal.

12. TROUBLESHOOTING

WARNING!

If you cannot solve a problem with the following solutions, do not attempt to repair it yourself. Turn the power off, unplug the printer, then contact your TOSHIBA TEC representative for assistance.

If the error lamp lights during printing, refer to the following troubleshooting to solve the problem.

Error type	Problem	Solution
PAPER JAM	<ol style="list-style-type: none"> The paper is not fitted correctly. The paper path is jammed and does not feed smoothly. The installed paper type does not match the selected sensor. The installed paper size is different from the programmed size. The feed gap sensor cannot see the difference between the print area and the gap. 	<ol style="list-style-type: none"> Reload the paper correctly. → Press the [PAUSE] key. Remove the cause of the jam and replace the paper correctly. → Press the [PAUSE] key. Turn the power off then on again. Select the correct sensor. → Feed the paper. Turn the power off then on again. Set the correct paper size. → Feed the paper. Set the threshold (see page 9-1). Else Turn the power off and call your Authorized Service representative.
HEAD OPEN	Feeding or printing has been attempted while the print head is raised.	Lower the print head block. → Press the [PAUSE] key.
NO PAPER	The paper has run out.	Load new paper. → Press the [PAUSE] key.
EXCESS HEAD TEMP.	The print head is too hot.	Turn the power off and decrease the print head temperature.
RIBBON ERROR	<ol style="list-style-type: none"> The ribbon has run out. There is a fault with the ribbon sensor. 	<ol style="list-style-type: none"> Load a new ribbon. → Press the [PAUSE] key. Turn the power off and contact your Authorized Service representative.

Error type	Problem	Solution
CUTTER ERROR	Paper is jammed in the cutter.	Remove the jammed paper and feed the undamaged media through the cutter (See page 11-3). → Press the [PAUSE] key. Else Turn the power off and contact your Authorized Service representative.
Other Error	Hardware or software trouble.	Turn the power off then on again. If the problem still exists turn the power off and contact your Authorized Service representative.

NOTE: *If an error cannot be cleared by pressing the **[PAUSE]** key, the power must be switched off then on again.
Once the power has been switched off and on, all the print data in the printer is cleared.*

Problem	Solution
No print.	1. Check that the paper and ribbon are loaded correctly. 2. Check that print head is set correctly. 3. Check the cabling between the printer and the host.
Dots missing in the print.	Dirty print head. → Clean the print head. Call your Authorized Service representative if necessary.
Unclear (or blurred) printing.	1. Dirty print head. → Clean the print head. 2. Bad or faulty ribbon. → Replace ribbon. 3. Poor paper quality. → Change paper type.
Power does not come on.	1. Plug power cord into an AC socket. 2. Check the circuit breakers or fuses. 3. Plug another appliance into the AC socket to check if there is power supplied. Call your Authorized Service representative if necessary.
Printer does not cut.	Check for a paper jam in the cutter. Call your Authorized Service representative if necessary.
You see a raised nap where the paper has been cut.	1. Clean the cutter blades. 2. The blades are worn. → Call your Authorized Service representative.

APPENDIX

■ ASCII Code Chart

	0	1	2	3	4	5	6	7	8	9	A	B	C	D	E	F
0				0	@	P	`	p	Ç	É	á	€		ð	Ó	—
1			!	1	A	Q	a	q	ü	æ	í	€		Ð	ß	±
2			"	2	B	R	b	r	é	Æ	ó			È	Ò	=
3			#	3	C	S	c	s	â	ô	ú			Ê	Ô	¼
4			\$	4	D	T	d	t	à	ö	ñ			È	ö	¶
5			%	5	E	U	e	u	à	ò	Ñ	Á		×	Õ	§
6			&	6	F	V	f	v	â	û	+	À	ā	Í	μ	÷
7			'	7	G	W	g	w	ç	ù	⊕	À	Ā	Ī	þ	°
8			(8	H	X	h	x	ê	ÿ	¿	⊖		Ī	Þ	◊
9)	9	I	Y	i	y	ë	ÿ	⊗			Ú	¨	◊
A			*	:	J	Z	j	z	è	Û	¬			Ú	·	◊
B			+	;	K	[k	l	ï	ø	½			Ù	¹	◊
C			,	<	L	\	l	l	î	£	¼			ý	³	◊
D			-	=	M]	m	ñ	ï	ø	¼			ÿ	²	◊
E			.	>	N	^	n	~	Ä	×	«	¥		ì	—	◊
F			/	?	O	_	o	⌘	Å	f	»		□		·	◊

■ Font Sample

A/0123456789@ABCDEFGHIJKL G/0123456789@ABCDEFGHIJKLMNQRST
 B/0123456789@ABCDEF H/0123456789@ABCDEFGHIJ
 C/0123456789@ABCDEF I /0123456789@ABCDEF
 D/0123456789@ABCDEF J /0123456789@ABCDEF
 E/0123456789@ABCD K/0123456789@ABC
 F/0123456789@ABCDEF L /0123456789@ABCDEF
M/0123456789@ABCDEFGHIJKLM
 N/0123456789@ABCDEFGHIJKLMNO
 O/0123456789@ABCDEFGHIJKLMNO
 P/0123456789@ABCDEFGHI
 Q/0123456789@ABCDEFGHI
 R/0123456789@ABCDEF
 S/0123456789@ABCDEF
 T/0123456789@ABCDEF

ABC

■ Barcode Sample

<p style="font-size: 0.8em; margin: 0;">*ABCDEFGHI1234F*</p>	<p>0: JAN8, EAN8</p> <p>494010458</p>	<p>4: NW7</p> <p>a1234567890a</p>
	<p>2: ITF</p> <p>012345678905</p>	<p>5: JAN13, EAN13</p> <p>901480079516</p>
	<p>3: CODE39 (Standard)</p> <p>*ABC123*</p>	<p>9, A: CODE128</p> <p>ABCDEFGHI</p>

INDEX

- A**
- AC Power inlet 3-1
 - Auto media feed 4-1
- B**
- Bar code types 2-1
- C**
- Cleaning 11-1
- D**
- DIP switch 3-1, 4-1
- F**
- Fonts 2-1
- I**
- Interface 1-1, 2-1
 - Centronics cable 5-1
 - Parallel interface 2-1
 - RS-232C cable description 5-1
 - Serial interface 2-1
 - Serial interface cable 6-1
 - Serial interface connector 3-1
 - Issue mode 1-1
- J**
- Jammed paper 11-3
- L**
- Label length 2-2
 - Label width 2-2
- O**
- Operation panel 3-1
 - ERROR LED 3-1
 - FEED key 3-1
 - ON-LINE LED 3-1
 - PAUSE key 3-1
 - POWER LED 3-1
 - Option 2-2
 - Cutter 11-4
 - Cutter module 2-2, 8-3
 - Expansion I/O interface board 2-2
 - Keyboard module 2-2
 - Strip mechanism 1-1
 - Strip module 2-2
- P**
- Paper 2-2, 10-1
 - Paper jam 12-1
 - Power consumption 2-1
 - Power cord 1-1, 6-1
 - Power switch 3-1
 - Print head 1-1, 2-1, 11-1
 - Print head cleaner 11-1
 - Print length 2-2
 - Print speed 2-1
 - Print width 2-2
 - Printing method 2-1
 - Program down load operation 4-1
- R**
- Relative humidity 2-1
 - Resolution 1-1
 - Ribbon 2-2, 7-1, 10-1
- S**
- Sensor
 - Black mark sensor 11-2
 - Feed gap sensor 11-2
 - Sensor adjustment mode 4-1
 - Specifications 2-1
 - Stacker 4-1
 - Supply holder 1-1, 3-1, 8-1
 - Supply holder unit 1-1, 2-1, 6-1
 - Supply voltage 2-1
- T**
- Thermal print head 2-1
 - Thermal transfer 1-1, 2-1
 - Threshold manual setting mode 4-1
 - Threshold setting 9-1
 - Transmission speed 4-1
 - Troubleshooting 12-1
 - Two-dimensional code 2-1
- W**
- Weight 2-1



TEC
TOSHIBA TEC CORPORATION

E PRINTED IN JAPAN
EO1-33006