



DVD Home Theatre System

Operating Instructions



AVJ-X33

Safety Precautions

WARNING: TO PREVENT FIRE OR ELECTRIC SHOCK HAZARD, DO NOT EXPOSE THIS PRODUCT TO RAIN OR MOISTURE.

WARNING: Do not install this equipment in a confined space such as a book case or similar unit.

To prevent fire, do not cover the ventilation of the apparatus with news papers, table-cloths, curtains, etc. And don't place lighted candles on the apparatus.



Don't throw away the battery with general house waste, dispose of it correctly as chemical waste.

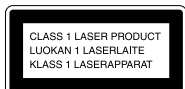

This appliance is classified as a CLASS 1 LASER product. The label is located on the rear exterior.

CAUTION:

This DVD Receiver employs a Laser System.

To ensure proper use of this product, please read this owner's manual carefully and retain it for future reference. Should the unit require maintenance, contact an authorized service location (see service procedure).

Performing controls, adjustments, or carrying out procedures other than those specified herein may result in hazardous radiation exposure.

To prevent direct exposure to laser beam, do not try to open the enclosure. Visible laser radiation when open. **DO NOT STARE INTO BEAM.**

CAUTION: The apparatus should not be exposed to water (dripping or splashing) and no objects filled with liquids, such as vases, should be placed on the apparatus.

Precautions

Safety

- If anything falls into the cabinet, unplug the unit and have it checked by qualified personnel before operating it any further.
- The unit is not disconnected from the AC power source (mains) as long as it is connected to the mains outlet, even if the unit itself has been turned off.
- Unplug the unit from the wall outlet if you do not intend to use it for an extended period of time. To disconnect the cord, pull it out by the plug, never by the cord.

Installing

- Allow adequate air circulation to prevent internal heat buildup.
- Do not place the unit on surfaces (rugs, blankets, etc.) or near materials (curtains, draperies) that may block the ventilation slots.
- Do not install the unit near heat sources such as radiators, or air ducts, or in a place subject to direct sunlight, excessive dust, mechanical vibration, or shock.
- Do not install the unit in an inclined position. It is designed to be operated in a horizontal position only.
- Keep the unit and discs away from equipment with strong magnets, such as microwave ovens, or large loudspeakers.
- Do not place heavy objects on the unit.
- If the unit is brought directly from a cold to a warm location, moisture may condense inside the DVD Home Theatre System and cause damage to the lenses. When you first install the unit, or when you move it from a cold to a warm location, wait for about 30 minutes before operating the unit.

On power sources

- AC power cord must be changed only at the qualified service shop.

On placement

- Place the receiver in a location with adequate ventilation to prevent heat build-up in the system.
- At high volume, over long periods of time, the cabinet becomes hot to the touch. This is not a malfunction. However, touching the cabinet should be avoided. Do not place the unit in a confined space where ventilation is poor as this may cause overheating.
- Do not block the ventilation slots by putting anything on the system. The receiver is equipped with a high power amplifier. If the ventilation slots on the top surface are blocked, the unit can overheat and malfunction.
- Do not place the system on a soft surface such as a rug that might block the ventilation holes on the bottom.
- Do not place the system in a location near heat sources, or in a place subject to direct sunlight, excessive dust, or mechanical shock.

On operation

- If the system is brought directly from a cold to a warm location, or is placed in a very damp room, moisture may condense on the lenses inside the system. Should this occur, the system may not operate properly. In this case, remove the disc and leave the system turned on for about half an hour until the moisture evaporates.
- When you move the system, take out any discs. If you don't, the disc may be damaged.

The nameplate is located on the rear of the unit.

IMPORTANT NOTICE

Caution: This system is capable of holding a still video image or on-screen display image on your television screen indefinitely. If you leave the still video image or on-screen display image displayed on your TV for an extended period of time you risk permanent damage to your television screen. Projection televisions are especially susceptible to this.

NOTES ON COPYRIGHTS:

It is forbidden by law to copy, broadcast, show, broadcast via cable, play in public, or rent copyrighted material without permission.

This product features the copy protection function developed by Macrovision. Copy protection signals are recorded on some discs. When recording and playing the pictures of these discs on a VCR, picture noise will appear.

This product incorporates copyright protection technology that is protected by method claims of certain U.S. patents and other intellectual property rights owned by Macrovision Corporation and other rights owners. Use of this copyright protection technology must be authorized by Macrovision Corporation, and is intended for home and other limited viewing uses only unless otherwise authorized by Macrovision Corporation. Reverse engineering or disassembly is prohibited.

About the symbols for instruction

 Indicates hazards likely to cause harm to the unit itself or other material damage.

Note Indicates special operating features of this unit.

Tip Indicates tips and hints for making the task easier.

Table of Contents

Introduction

Safety Precautions	2-3
Table of Contents	4
Before Use	5-6
Playable Discs	5
Precautions	6
Notes on Discs	6
About Symbols	6
Front Panel Controls	7
Display Window Indicators	8
Remote Control	9
Rear Panel Connections	10

Preparation

Connections	11-15
Connecting to a TV	11
Connecting to External Equipment	12
Antenna Connections	13
Speaker System Connection	14
Speaker Positioning	15
Selecting the Output/Input Source	16
Before Operation	17-21
Mini Glossary for Audio Stream & Surround	
Mode	17
Sound Mode	17
General Explanation	18
On-Screen Display	18
Initial Settings	19-21
• General Operation	19
• Language	19
• TV Aspect	19
• Speaker Setup	20
• Others	20
• Parental Control	21
• Area code	21

Operation

DVD and Video CD Operation	22-24
Playing a DVD and Video CD	22
General Features	22
• Resume Function	22
• Selecting Another TITLE	22
• Selecting Another CHAPTER/TRACK	22
• Search	22
• Still Picture	22
• Slow Motion	23
• Repeat	23
• Time Search	23
Special DVD Features	24
• Checking the contents of DVD Video disc: Menus	24
• Camera Angle	24
• Changing the Audio Language	24
• Changing the Audio Channel	24
• Subtitle	24

Audio CD and MP3 Disc Operation	25-26
Playing an Audio CD and MP3 Disc	25
Notes on MP3 Files	25
• Pause	26
• Selecting Another Track	26
• Search	26
• Repeat	26
• Changing the Audio Channel	26
JPEG File Operation	27
Viewing JPEG Files on a Disc	27
• Selecting Another Files	27
• Still Picture	27
• To flip the picture	27
• To rotate picture	27
• Notes on JPEG Files	27
Programmed Playback	28
Programmed Playback with Audio CD and MP3 Disc	28
Programmed Playback with Video CD	28
Speaker Setup	29
Additional Information	30-31
Sleep Timer Setting	30
Viewing the Playing Time and Remaining Time in the Front Panel Display	30
Dimmer	30
Muting	30
Using Headphone Jack	30
Volume Control	30
Using the Sound Effect	30
Using the Karaoke Function	31
Radio Operation	32
Presetting the Radio Stations	32
Listening to the Radio	32
Controlling the TV with the Supplied Remote	33
Controlling the TV	33

Reference



Language Code List	34
Area Code List	35
Troubleshooting	36-37
Specification	38

Manufactured under license from Dolby Laboratories. "Dolby", "Pro Logic", and the double-D symbol are trademarks of Dolby Laboratories. Confidential Unpublished works. Copyright 1992-1997 Dolby Laboratories. All rights reserved.

Manufactured under license from Digital Theater Systems, Inc. US Pat. No. 5,451,942 5,956,674, 5,974,380, 5,978,762 and other world-wide patents issued and pending. "dts" and "DTS Digital Surround" are trademarks of Digital Theatre Systems, Inc. Copyright 1996, 2000 Digital Theater Systems, Inc. All rights reserved.

Before Use

Playable Discs

	DVD video discs (8 cm / 12 cm disc)
	Video CD (VCD) (8 cm / 12 cm disc)
	Audio CD (8 cm / 12 cm disc)

In addition, this unit can play a DVD-R/-RW, SVCD and CD-R or CD-RW that contains audio titles, MP3, or JPEG files.

Notes

- Depending on the conditions of the recording equipment or the CD-R/RW (or DVD-R/-RW) disc itself, some CD-R/RW (or DVD-R/-RW) discs cannot be played on the unit.
- DVD-RWs in VR (Video Recording) mode discs cannot be played on the unit.
- Do not attach any seal or label to either side (the labeled side or the recorded side) of a disc.
- Do not use irregularly shaped CDs (e.g., heart-shaped or octagonal). It may result in malfunctions.

Notes on DVDs and Video CDs

Some playback operations of DVDs and Video CDs may be intentionally fixed by software manufacturers. As this unit plays DVDs and Video CDs according to disc content designed by the software manufacturer, some playback features of the unit may not be available or other functions may be added.

Make sure to also refer to the instructions supplied with the DVDs and Video CDs. Some DVDs made for business purposes may not be able to be played on the unit.

Regional code of the DVD Receiver and DVDs

This DVD Receiver is designed and manufactured for playback of region "4" encoded DVD software. The region code on the labels of some DVDs indicates which type of player can play those discs. This unit can only play DVDs labeled "4" or "ALL". If you try to play any other discs, the message "Check Regional Code" will appear on the TV screen. Some DVDs that have no region code label may still be subject to area restrictions and therefore not playable.



Disc-related terms

Title (DVD video discs only)

The main film content or accompanying feature content or additional feature content, or music album. Each title is assigned a title reference number enabling you to locate it easily.

Chapter (DVD video discs only)

Sections of a picture or a musical piece that are smaller than titles. A title is composed of one or several chapters. Each chapter is assigned a chapter number, enabling you to locate the chapter you want. Depending on the disc, chapters may not be recorded.

Track (Video CD and audio CD only)

Sections of a picture or a musical piece on a video CD or an audio CD. Each track is assigned a track number, enabling you to locate the track you want.

Index (Video CD)

A number that divides a track into sections to easily locate the point you want on a VIDEO CD. Depending on the disc, no indexes may be recorded.

Scene

On a video CD with PBC (Playback control) functions, moving pictures and still pictures are divided into sections called "Scenes". Each scene is displayed in the menu screen and assigned a scene number, enabling you to locate the scene you want.

A scene is composed of one or several tracks.

File

Sections of a picture on a data CD containing JPEG image files.

Types of video CDs

There are two types of video CDs:

Video CDs equipped with PBC (Version 2.0)

PBC (Playback control) functions allow you to interact with the system via menus, search functions, or other typical computer-like operations. Moreover, still pictures of high resolution can be played if they are included in the disc.

Video CDs not equipped with PBC (Version 1.1)

Operated in the same way as audio CDs, these discs allow playback of video pictures as well as sound, but they are not equipped with PBC.

IMPORTANT NOTE:

SPENT OR DISCHARGED BATTERIES MUST BE RECYCLED OR DISPOSED OF IN A SAFE MANNER IN COMPLIANCE WITH ALL APPLICABLE LAWS. FOR DETAILED INFORMATION, CONTACT YOUR LOCAL COUNTY SOLID WASTE AUTHORITY.

Before Use (Continued)

Precautions

Handling the unit

When shipping the unit

The original shipping carton and packing materials may come in handy. For maximum protection, re-pack the unit as it was originally packed at the factory.

When setting up the unit

The picture and sound of a nearby TV, VCR, or radio may be disturbed during playback. In this case, position the unit away from the TV, VCR, or radio, or turn off the unit after removing the disc.

To keep the exterior surfaces clean

Do not use volatile liquids, such as insecticide spray, near the unit. Do not leave rubber or plastic products in contact with the unit for a long period of time. They will leave marks on the surface.

Cleaning the unit

To clean the cabinet

Use a soft, dry cloth. If the surfaces are extremely dirty, use a soft cloth lightly moistened with a mild detergent solution. Do not use strong solvents such as alcohol, benzene, or thinner, as these might damage the surface of the unit.

To obtain a clear picture

The DVD Receiver is a high-tech, precision device. If the optical pick-up lens and disc drive parts are dirty or worn, the picture quality will be poor.

Regular inspection and maintenance are recommended after every 1,000 hours of use. (This depends on the operating environment.)

For details, please contact your nearest dealer.

Notes on Discs

Disc Handling

Do not touch the playback side of the disc.

Hold the disc by the edges so that fingerprints will not get on the surface.

Do not stick paper or tape on the disc.

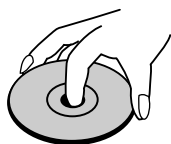

Storing discs

After playing, store the disc in its case.

Do not expose the disc to direct sunlight or sources of heat, or leave it in a parked car exposed to direct sunlight, as there may be a considerable temperature increase inside the car.

Cleaning discs

Fingerprints and dust on the disc can distort the picture or reduce sound quality. Before playing, clean the disc with a clean cloth. Wipe the disc from the centre outwards.

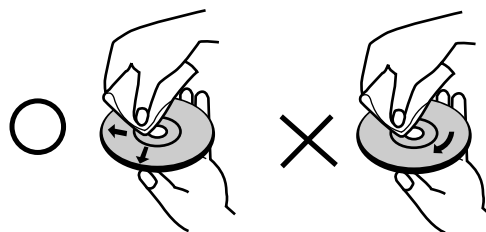

Do not use strong solvents such as alcohol, benzene, thinner, commercially available cleaners, or anti-static spray intended for vinyl records.

This system can only play back a standard circular disc. Using neither standard nor circular discs (e.g., card, heart, or star shape) may cause a malfunction.

Do not use a disc that has a commercially available accessory attached, such as a label or ring.







About Symbols

About the symbol display

“” may appear on the TV screen during operation. This icon means the function explained in this owner's manual is not available on that specific DVD video disc.

About the disc symbols for instructions

A section whose title has one of the following symbol is applicable only to the disc represented by the symbol.

-  DVD Video discs
-  Video CDs with the PBC (playback control) function.
-  Video CDs without the PBC (playback control) function.
-  Audio CDs.
-  MP3 disc.
-  JPEG disc.

Front Panel Controls

I / (POWER) indicator

Switches the DVD Receiver ON and OFF.

STANDBY indicator

Lights red when the receiver is in Standby mode (off).

Disc Tray

Insert a disc here.

OPEN/CLOSE ()

Opens or closes the disc tray.

VOLUME Control

Turn the knob clockwise to increase sound level, counterclockwise to decrease sound level.

STOP ()

Stops playback of a disc.

PAUSE ()

Pause playback of a disc temporarily.

PLAY ()

To play back a disc.

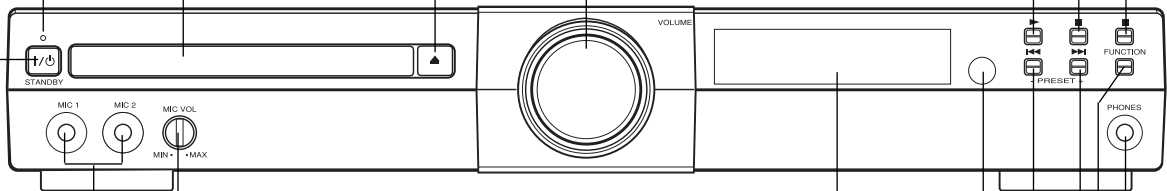

Display window

Remote Sensor

Point the DVD receiver remote control here.

Reverse SKIP ()

DVD: Go to beginning of current chapter/track or to previous chapter/track.

RADIO: To select preset station you want.

Forward SKIP ()

DVD: Go to NEXT chapter/track.

RADIO: To select preset station you want.

FUNCTION

To select the Receiver's source.
(FM, AM, VIDEO or CD/DVD)

MIC VOL (MIN/MAX)

Adjust the microphone volume.

MIC1, MIC2

To connect microphone.

PHONES

To connect headphones.

Display Window Indicators

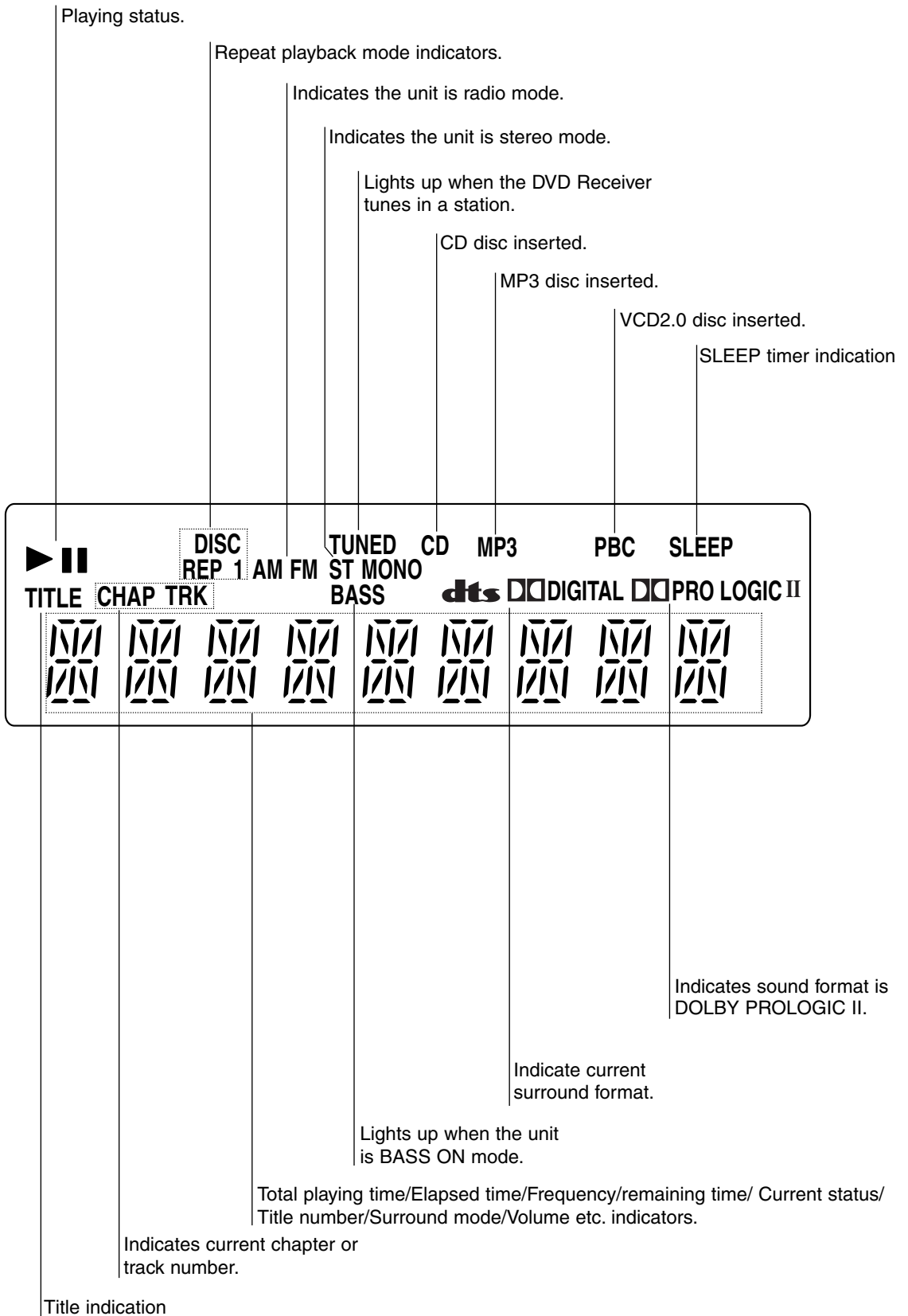

Remote Control

OPEN/CLOSE
Opens and closes the disc tray.

TV/VIDEO
Selects the TV's source.

0-9 numerical buttons
Selects numbered options in a menu.

>10/ TV ENTER
Used to control TV.

Playback Control Buttons

- ▶ (PLAY)**
Starts playback.
- ⏸ (PAUSE)**
Pause playback or recording temporarily.
- (STOP)**
Stops playback.
- PRESET-**
Go to beginning of current chapter or track or go to previous chapter or track. Select programme of Tuner.
- PRESET+**
Go to next chapter or track. Select programme of Tuner.
- SLOW ◀/ TUNING-**
For picture search or slow playback backward. To tune in the desired station.
- SLOW ▶/ TUNING+**
For picture search or slow playback forward. To tune in the desired station.
- DVD TOP MENU**
Displays the disc's Title menu, if available.
- ◀/▶/▲/▼ (left/right/up/down)**
Selects an option in the menu.
- ENTER**
Acknowledges menu selection.
- TV**
To control TVs with the Remote.
- REPEAT**
Repeat chapter, track, title, all
- SLEEP**
To place the unit in the Sleep mode.
- PROGRAM**
Enters to the programme edit mode or exits from that.
- DIMMER**
To change the brightness of the display window.
- KARAOKE**
To display the Karaoke menu audio channel.
- CLEAR**
Removes a track number on the program menu.
- DVD SETUP**
Accesses or removes DVD setup menu.

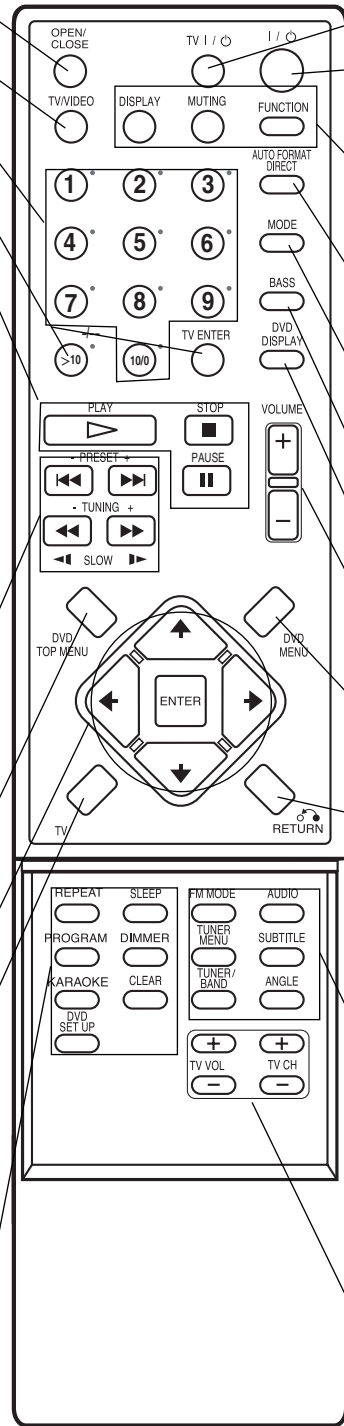

TV I / ⏻
Switches TV ON and OFF.

I / ⏻
Switches DVD Receiver ON and OFF.

DISPLAY
To display remaining time between Chapter and title.

MUTING
Momentarily silence the speaker of the DVD Receiver.

FUNCTION
To select the Receiver's source. (FM, AM, VIDEO or CD/DVD)

AUTO FORMAT DIRECT
Selects sound mode between A.F.D. AUTO, PRO LOGIC, PLII MOVIE and PLII MUSIC.

MODE
Selects sound mode between FLAT, ROCK, POP, JAZZ, CLASSIC, NEWS and LINK.

BASS
Switches BASS ON and OFF.

DVD DISPLAY
Accesses On-Screen display.

VOLUME (+/-)
Adjusts speaker volume.

DVD MENU
Accesses menu on a DVD disc.

RETURN
Returns the setup menu.

FM MODE
To change between MONO and STEREO modes.

AUDIO
Selects an audio language (DVD) or an audio channel (CD).

TUNER MENU
Memorize a radio station frequency into the tuner. Press to clear preset stations from the tuner memory.

SUBTITLE
Selects a subtitle language.

TUNER/BAND
Selects the DVD Receiver's tuner as the listening choice. (FM and AM bands)

ANGLE
Selects a DVD camera angle if available.

TV VOL +/-
Adjusts TV's volume.

TV CH +/-
Selects TV's channel.

Rear Panel Connections

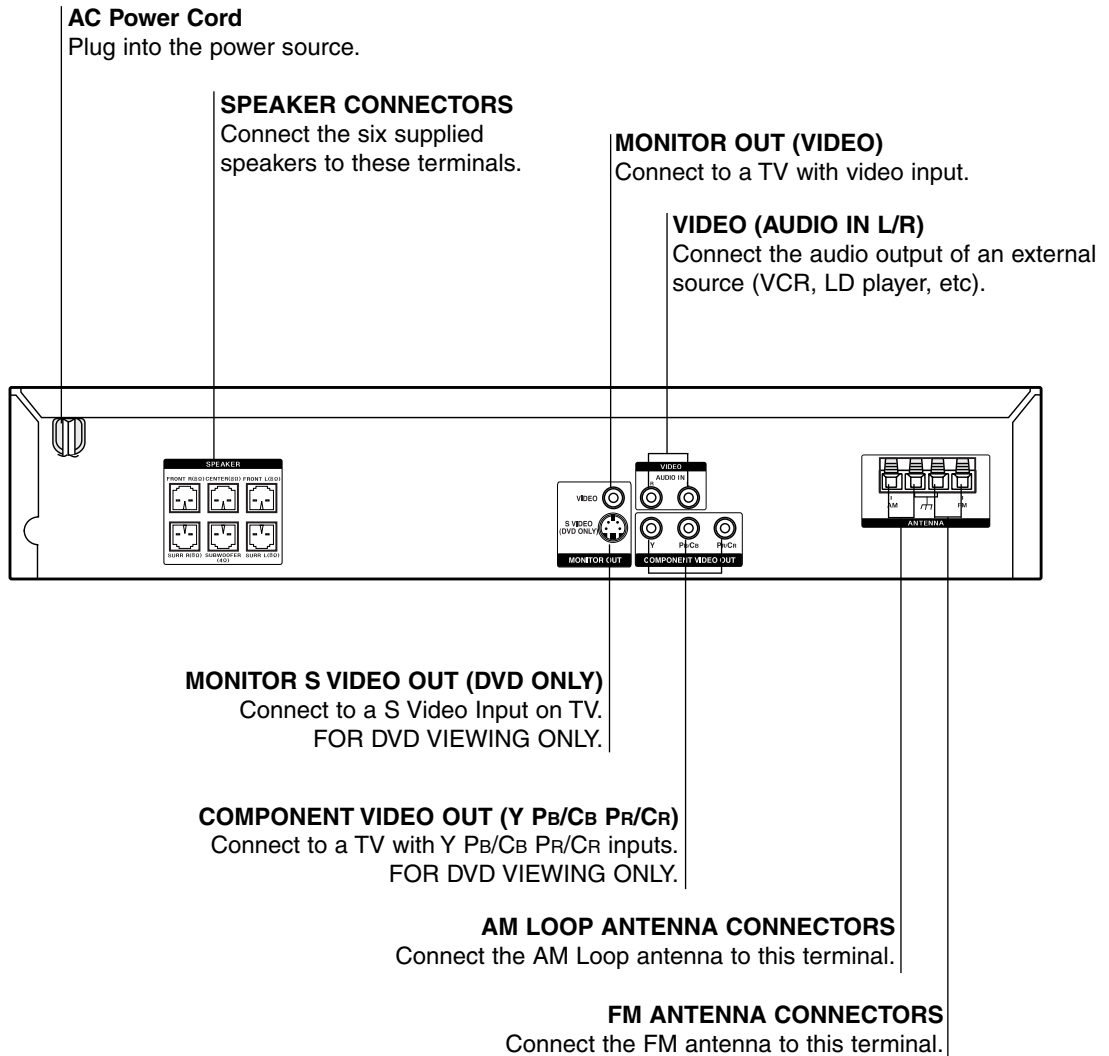

Do not touch the inner pins of the jacks on the rear panel. Electrostatic discharge may cause permanent damage to the unit.

Remote Control Operation Range

Point the remote control at the remote sensor and press the buttons.

- **Distance:** About 6m (20ft) from the front of the remote sensor
- **Angle:** About 30° in each direction of the front of the remote sensor

Remote control battery installation

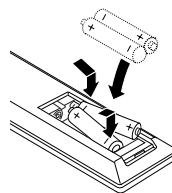

Detach the battery cover on the rear of the remote control, and insert two R03 (size AAA) batteries with **+** and **-** aligned correctly.

When using the remote control, point it at the remote sensor **R** on the unit.



Do not mix old and new batteries.

Connecting to a TV

- Make one of the following connections, depending on the capabilities of your existing equipment.

Tips

- Depending on your TV and other equipment you wish to connect, there are various ways you could connect the DVD Receiver. Use one of the connections described below.
- Please refer to the manuals of your TV, VCR or other devices as necessary to make the best connections.



- Make sure the DVD Receiver is connected directly to the TV. Select the correct AV input on your TV.
- Do not connect your DVD Receiver to TV via your VCR. The DVD image could be distorted by the copy protection system.

Video connection

Connect the MONITOR OUT VIDEO jack on the DVD Receiver to the video in jack on the TV using the video cable (V).

S-Video connection

Connect the S-VIDEO OUT jack on the DVD Receiver to the S-Video in jack on the TV using the S-Video cable (S).

Component Video (Color Stream®) connection

Connect the COMPONENT VIDEO OUT jacks on the DVD Receiver to the corresponding in jacks on the TV using an Y Pb Pr cable (C).

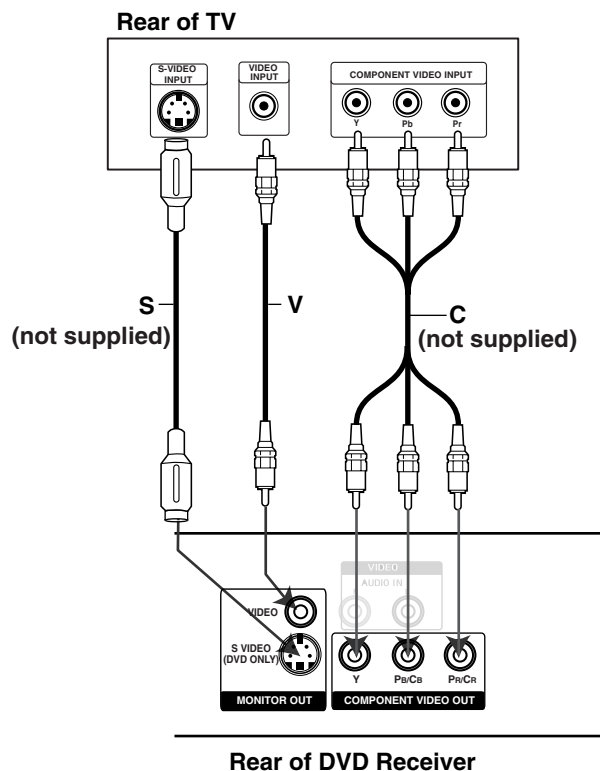

Connections (Continued)

Connecting to External Equipment

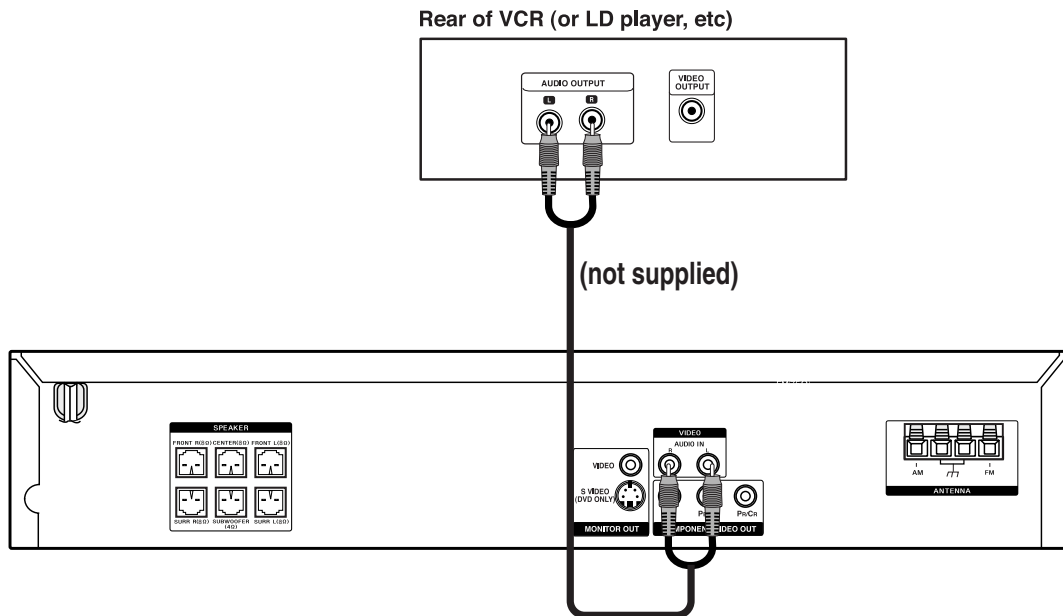

Connection

Connect the VIDEO (AUDIO R/L) jacks on the DVD Receiver to the AUDIO OUTPUT (L/R) jacks on the VCR, LD player, etc using the audio cables.

Tip

Press FUNCTION on the remote control to select input to these jacks. VIDEO appears on the Display Window.

Antenna Connections

Connect the supplied FM/AM antenna for listening to the radio.

- Connect the AM Loop antenna to the AM LOOP connector.
- Connect the FM antenna to the FM 75 Ω connector.
- When you connect the supplied AM Loop antenna, connect the black cord (B) to the rfl terminal, and the white cord (A) to the other terminal.

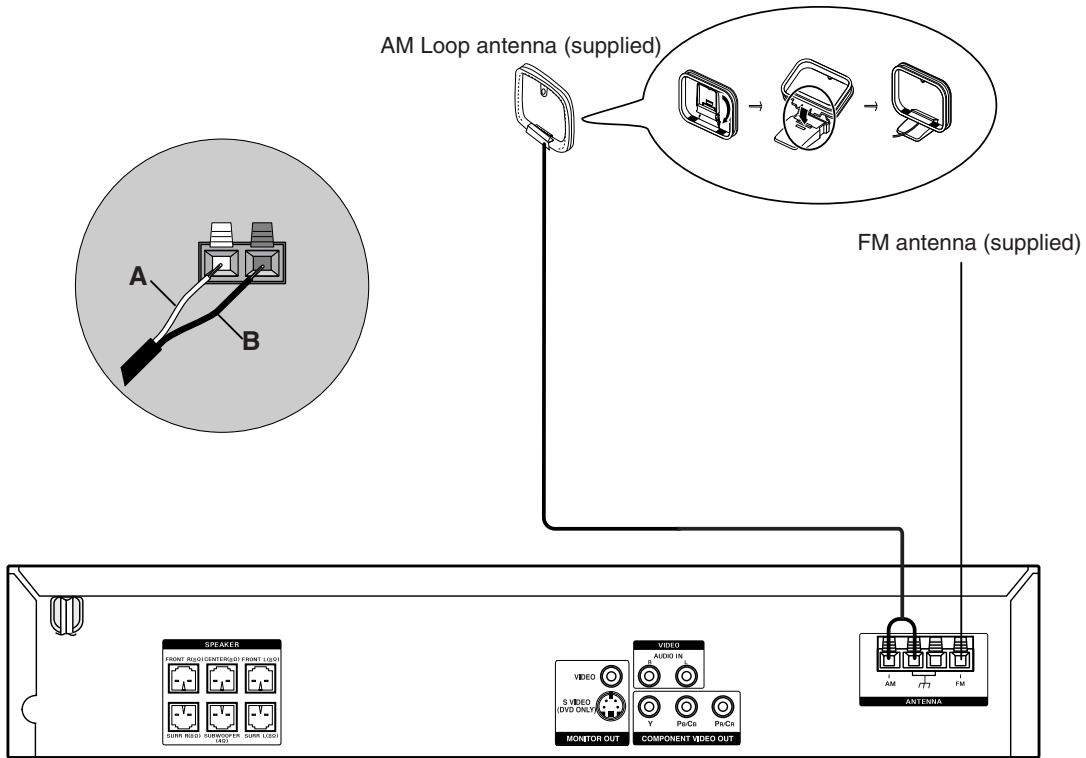

Notes

- To prevent noise pickup, keep the AM Loop antenna away from the DVD Receiver and other components.
- Be sure to fully extend the FM antenna.
- After connecting the FM antenna, keep it as horizontal as possible.

Tip

If you have poor FM reception, use a 75 Ω cable (not supplied) to connect the system to an outdoor FM antenna as shown below.

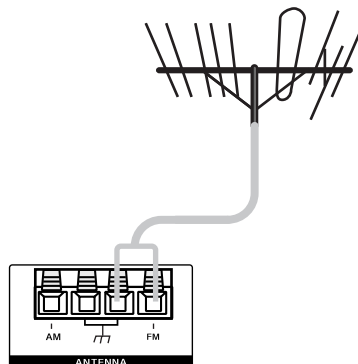

Connections (Continued)

Speaker System Connection

Connect the speakers using the supplied speaker cords.

To obtain the best possible surround sound, adjust the speaker parameters (volume, distance, etc.).

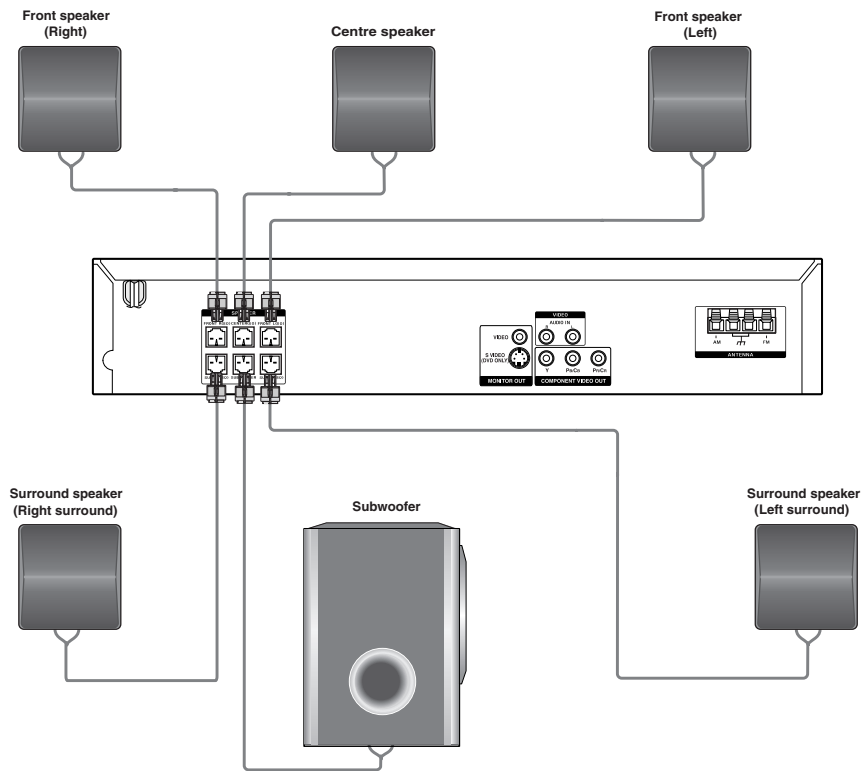

Notes

- Be sure to match the speaker cable to the appropriate terminal on the components: + to + and – to –. If the cables are reversed, the sound will be distorted and will lack base.
- If you use front speakers with low maximum input rating, adjust the volume carefully to avoid excessive output on the speakers.
- Do not disassemble the front covers of supplied speakers.
- Speaker stand is optional.

About Ferrite Core

Be sure to attach the ferrite core to the speaker cables (for connecting to this unit).

This ferrite core can reduce noises.

How to attach the ferrite core

- 1** Press the stopper [a] of the ferrite core to open.
- 2** Wind the Center cable once on the ferrite core. Pass the others straight on the ferrite core.
- 3** Close the ferrite core until it clicks.

Notes

- Take care not to pinch the speaker cables between the ferrite cores.
- Attach the ferrite core near the unit (Refer to the fig.3 and comment.).

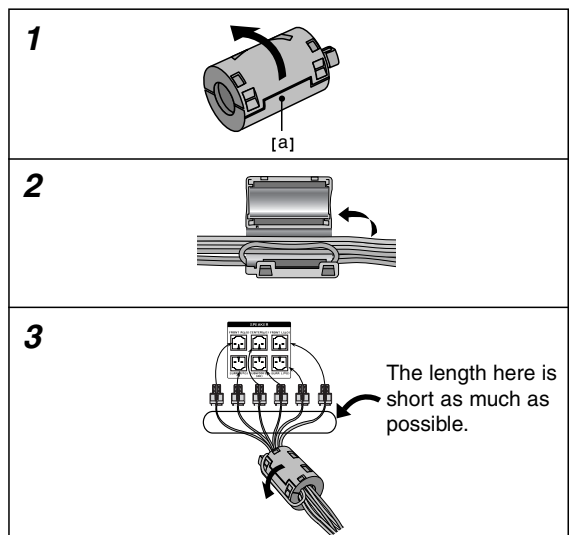

Speaker Positioning

In the case of normal position use the 6 speakers (2 front speakers, centre speaker, 2 surround speakers and subwoofer).

- **Front speakers**

According to your listening position set up the speakers for equal distance. And by hearing position set up the interval between speakers to 45 degree.

- **Centre speaker**

The centre speakers and front speakers are ideally the same height. But normally place it above or below the television.

- **Surround speakers**

Place left and right behind the listening area. These speakers recreate sound motion and atmosphere required for surround sound playback. For best results, do not install the surround speakers too far behind the listening position and install them at or above the level of the listener's ears. It is also effective to direct the surround speakers towards a wall or ceiling to further disperse the sound.

In the case of a smaller room size, if the audience is near to the rear wall set the surround speakers opposite each other, and set the surround speakers above 60 - 90 cm than the listener's ears.

- **Subwoofer**

This can be placed in any front position.

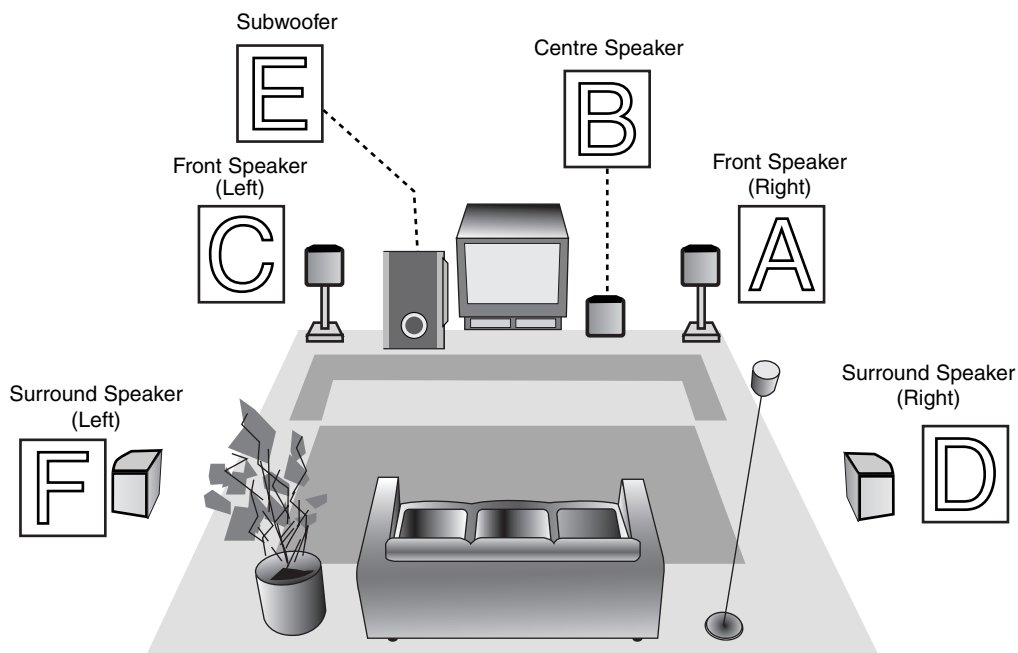

Speaker Positioning Example

Note

- Speaker stand is optional.

To attach the foot pads

To prevent speaker vibration or movement while listening, attach the supplied foot pads to the speakers without Subwoofer, as shown.

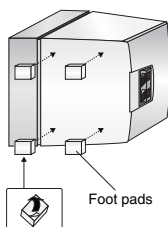

Selecting the Output/Input Source

Follow these guidelines to select and switch among the various DVD Receiver input and output sources:

- **CD/DVD**

To view output from the DVD:

Press **FUNCTION** on the remote.
The “CD/DVD” appears in the Display Window.

- **TUNER FM/AM**

To listen to AM/FM radio broadcasts:

Press **TUNER/BAND** to toggle between AM and FM radio. The selected frequency appears in the display window.

- **INPUT SELECT**

To listen to an audio source connected to the AUDIO IN (L/R) jack of VIDEO:

Press **FUNCTION** on the remote control repeatedly. The “VIDEO” appears in the Display Window. Audio will come from an external source connected to the AUDIO IN (L/R) jacks of VIDEO (for rear panel).

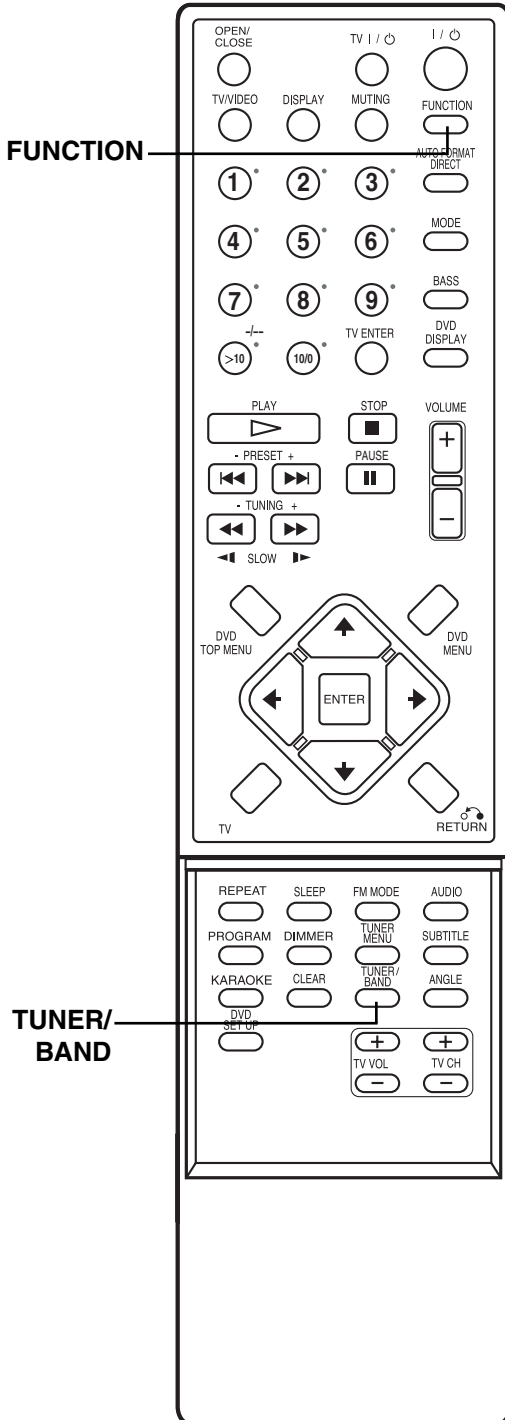

FUNCTION

**TUNER/
BAND**

Mini Glossary for Audio Stream & Surround mode

DTS

Allows you to enjoy 5.1(or 6) discrete channels of high quality digital audio from DTS program sources such as discs, DVD and compact discs, etc.bearing the trademark. DTS Digital Surround delivers up to 6 channels of transparent audio(which means identical to the original masters) and results in exceptional clarity throughout a true 360 degree sound field. The term DTS is a trademark of DTS Technology, LLC. Manufactured under license from DTS Technology, LLC.

DOLBY DIGITAL

The Dolby Digital surround format lets you enjoy up to 5.1 channels of digital surround sound from a Dolby Digital program source. If you play DVDs with “” mark, you can enjoy even better sound quality, greater spatial accuracy, and improved dynamic range.

DOLBY PRO LOGIC

Use this mode when playing movie or Dolby Digital 2 channel which carries the “” mark. This mode provides the effect of being in a movie theatre or live concert house-an effect with an intensity which can only be obtained through DOLBY PRO LOGIC SURROUND. The effect of the front/back/left/right movement of the sound image, as well as the sense of fixed position in the sound image, is much clearer and more dynamic than before.

DOLBY PRO LOGIC II

Dolby Pro Logic II creates five full-bandwidth output channels from two-channel sources. This is done using an advanced, high-purity matrix surround decoder that extracts the spatial properties of the original recording without adding any new sounds or tonal colorations.

PLII MOVIE mode:

The Movie mode is for use with stereo television shows and all programs encoded in Dolby Surround. The result is enhanced soundfield directionality that approaches the quality of discrete 5.1-channel sound.

PLII MUSIC mode:

The Music mode is for use with any stereo music recordings.

A.F.D. AUTO

Software with multichannel surround audio signals is played according to the way it was recorded.

Notes

- This function is available during only playback mode.
- A.F.D. AUTO is not applicable when headphone is used.

Sound Mode

You can enjoy surround sound simply by selecting one of the pre-programmed sound fields according to the program you want to listen to.

A) By pressing MODE button

Each time you press **MODE** button, the sound mode is changed in the following order;

FLAT → ROCK → POP → JAZZ → CLASSIC → NEWS → LINK → FLAT ...

Tips

- FLAT: Linear frequency response.
- ROCK: Reproduces the acoustics of rock music.
- POP: Reproduces the acoustics of pop music.
- JAZZ: Reproduces the acoustics of a jazz club.
- CLASSIC: Reproduces the acoustics of orchestral music.
- NEWS: Reproduces the acoustics of TV news sound.
- LINK: Reproduces the same sound from the front speaker (L/R) and surround speaker (L/R).
(This function available 2-channel mode only)

B) By pressing AUTO FORMAT DIRECT button

Each time you press **AUTO FORMAT DIRECT** button, the sound mode is changed in the following order;

A.F.D. AUTO → DOLBY PL → PLII MOVIE → PLII MUSIC → A.F.D. AUTO ...

(This function available 2-channel mode only)

Notes





- MP3 disc is not available.
- This function is available during only playback mode.
- Sound Mode is not applicable when headphone is used.

When DVD is inserted.



You can change the sound mode of DVD (Dolby Digital, DTS, PRO LOGIC, etc) by pressing the **AUDIO** button on the remote during playback.

Although the DVD contents differ from disc to disc, the following explains the basic operation when this feature is used.

Each time you press **AUDIO** button, the sound mode of DVD is changed as the following order;

 DIGITAL →  →  →  DIGITAL

For your reference

- **The DVD Receiver memorizes the last mode settings for each source individually.**
- **You can identify the encoding format of program software by looking at its packaging.**
 - Dolby Digital discs are labeled with the  logo.
 - Dolby Surround encoded programs are labeled with the  logo.
 - DTS Digital Surround discs are marked with the .

Note

- Sound Mode is not applicable when headphone is used.

Before Operation (Continued)



General Explanation

This manual gives basic instructions for operating the DVD Receiver. Some DVDs require specific operation or allow only limited operation during playback. When this occurs, the symbol  appears on the TV screen, indicating that the operation is not permitted by the DVD Receiver or is not available on the disc.







On-Screen Display

General playback status can be displayed on the TV screen. Some items can be changed on the menu.

On-screen display operation

- 1** Press DVD DISPLAY during playback.
- 2** Press  to select an item.
The selected item will be highlighted.
- 3** Press  to change the setting of an item.
The number buttons can also be used for setting numbers (e.g., title number). For some functions, press ENTER to execute the setting.





















Temporary Feedback Field Icons

-  Repeat Title
-  Repeat Chapter
-  Repeat Track (non-PBC Video CDs, MP3, CD)
-  Repeat All Tracks (non-PBC Video CDs, MP3, CD)
-  Repeat Off
-  Resume play from this point
-  Action prohibited or not available









Notes

- Some discs may not provide all of the features on the on-screen display example shown below.
- If no button is pressed for 10 seconds, the on-screen display disappears.

DVD

Items	Function (Press  to select desired item)	Selection Method
Title Number	 1 / 3 Shows the current title number and total number of titles, and skips to the desired title number.	 /  , or Numbers, ENTER
Chapter Number	 1 / 12 Shows the current chapter number and total number of chapters, and skips to the desired chapter number.	 /  ,  /  or Numbers, ENTER
Time search	 0:20:09 Shows the elapsed playing time, and searches the point directly from the elapsed time.	Numbers, ENTER
Audio language and Digital Audio Output mode	 1 ENG 5.1 CH Shows the current audio soundtrack language, encoding method, and channel number, and changes the setting.	 /  , or AUDIO
Subtitle language	 OFF Shows the current subtitles language, and changes the setting.	 /  , or SUBTITLE
Angle	 1 / 1 Shows the current angle number and total number of angles, and changes the angle number.	 /  , or ANGLE
Sound	 AUTO Shows the current sound mode, and changes the setting.	AUTO FORMAT DIRECT

VCD2.0 VCD1.1

Items	Function (Press  to select desired item)	Selection Method
Track Number	 1 / 3 Shows the current track number, total number of tracks, PBC On mode or skips to the desired track number in the PBC Off mode	 /  , or Numbers, ENTER
Time	 0:20:09 Shows the elapsed playing time (Display only)	-
Audio Channel	 ST Shows the audio channel, and changes the audio channel.	 /  , or AUDIO
Sound	 AUTO Shows the current sound mode, and changes the setting.	AUTO FORMAT DIRECT

Before Operation (Continued)

Initial Settings

You can set your personal preferences on the DVD function mode.



Menu Language

Select a language for the Setup menu. This is the menu you see when you press DVD SETUP.



General Operation

- 1 Press DVD SETUP.**
The Setup menu appears.
- 2 Use ↑/↓ to select the desired option.**
The screen will show the current setting for the selected option, as well as alternate setting(s).
- 3 While the desired option is selected, press →, then ↑/↓ to select the desired setting.**
- 4 Press ENTER to confirm your selection.**
Some options require additional steps.
- 5 Press DVD SETUP, RETURN, or ▷ (PLAY) to exit the setup menu.**

TV Aspect **DVD**

4:3 Letterbox: Select when a standard 4:3 TV is connected. Displays pictures with masking bars above and below the picture.

4:3 Panscan: Select when a standard 4:3 TV is connected. Displays pictures cropped to fill your TV screen. Both sides of the picture are cut off.

16:9 Wide: Select when a 16:9 wide TV is connected.

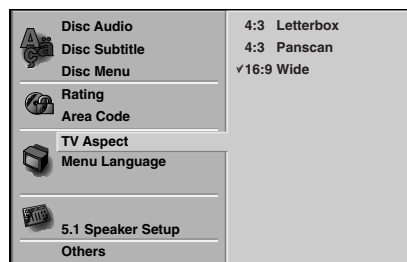

Language

Disc Language **DVD**

Select a language for the disc's Menu, Audio, and Subtitle features.

Original : The original language set for the disc is selected.

Other : To select another language, use number buttons to enter the corresponding 4-digit number according to the language code list on page 34. If you enter the wrong language code, press CLEAR.



Note

Disc Language selection may not work for some DVDs.

Before Operation (Continued)

Speaker Setup

5.1 Speaker settings **DVD**

Select speaker settings, including volume balance and distance, or test the speaker settings.

Speaker settings are only active on the Analog Multi-Channel Output. (See "Speaker Setup", page 29.)

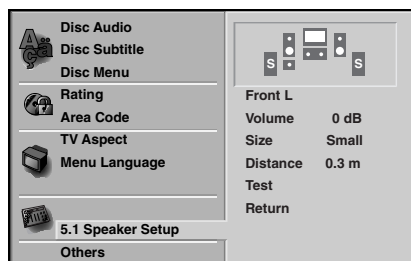

Others

The DRC and PBC settings can be changed.

- Press $\blacktriangle/\blacktriangledown$ to select the desired item and press ENTER. The setting of the selected item is changed between On and Off.

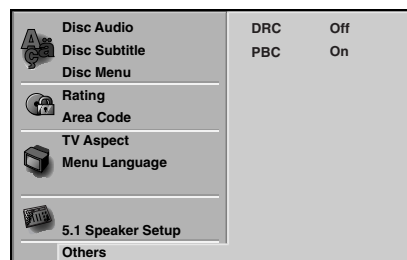

Dynamic Range Control (DRC)

With the DVD*¹ format, you can hear a program's soundtrack in the most accurate and realistic presentation possible, thanks to digital audio technology. However, you may wish to compress the dynamic range of the audio output (the difference between the loudest sounds and the quietest ones). Then, you may listen to a movie at a lower volume without losing clarity of sound. Set DRC to On for this effect.

*1: Dolby Digital only

Playback Control (PBC)

On: Video CDs with PBC are played according to the PBC.
Off: Video CDs with PBC are played the same way as Audio CDs.

Before Operation (Continued)

Parental Control

Rating **DVD**

Movies on DVDs may contain scenes not suitable for children. Therefore, discs may contain Parental Control information that applies to the complete disc or to certain scenes on the disc. These scenes are rated from 1 to 8, and alternatively, more suitable scenes are available for selection on some discs. Ratings are country dependent. The Parental Control feature allows you to prevent discs from being played by your children or to have certain discs played with alternative scenes.

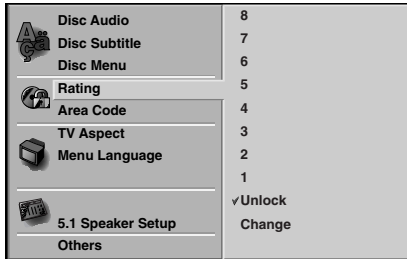

- 1** Select Rating on the setup menu using **▲/▼** buttons on the setup menu.
- 2** While Rating is selected, press **▶**.
- 3** When you have not entered a password yet. Enter a 4-digit password using the number buttons to create a personal 4-digit security password, then press ENTER. Enter the 4-digit password again and press ENTER to verify.
When you have already entered a password; Enter a 4-digit password using the number buttons to confirm the personal 4-digit security password, then press ENTER.

If you make a mistake before pressing ENTER, press CLEAR and enter 4-digit security password again.
- 4** Select a rating from 1 to 8 using **▲/▼** buttons. **One (1) has the least playback restrictions. Eight (8) has the most playback restrictions.**
Unlock: If you select Unlock, Parental Control is not active. The disc will play in full.
Ratings 1 to 8: Some discs contain scenes not suitable for children. If you set a rating for the DVD, all disc scenes with the same rating or lower will be played. Higher rated scenes will not be played unless an alternative scene is available on the disc. The alternative must have the same rating or a lower one. If no suitable alternative is found, playback will stop. You must enter the 4-digit password or change the rating level in order to play the disc.
- 5** Press ENTER to confirm your rating selection, then press DVD SETUP to exit the menu.

Area Code **DVD**

Enter the code of an area whose standards were used to rate the DVD video disc, referring to the list (See "Area Code List", page 35.).

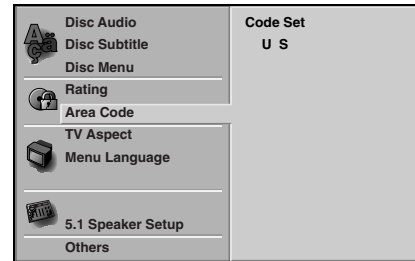

- 1** Select the Area Code option using the **▲/▼** buttons on the setup menu.
- 2** While Area Code is selected, press **▶**.
- 3** Follow step 3 of "Rating" on left.
- 4** Select the first character using the **▲/▼** buttons.
- 5** Press **▶** to shift to second character and select the second character using **▲/▼** buttons.
- 6** Press ENTER to confirm your Area Code selection, then press DVD SETUP to exit the menu.

Note

Confirmation of the 4-digit password is necessary when the password is changed (see Changing the 4-digit password below).

Changing the 4-digit password

- 1 Follow Steps 1-2 as shown above to the left (Rating).
- 2 Enter the old password, then press ENTER.
- 3 Select Change using **▲/▼** buttons then press ENTER.
- 4 Enter the new 4-digit password, then press ENTER.
- 5 Enter exactly the same password a second time and verify by pressing ENTER.
- 6 Press DVD SETUP to exit the menu.

If you forget your 4-digit password

If you forget your password, to clear the current password follow the procedure below.

- 1 Press DVD SETUP to display the setup menu.
- 2 Enter the 6-digit number "210499".
The 4-digit password is cleared.
- 3 Enter a new password as shown above to the left (Rating).

DVD and Video CD Operation

Playing a DVD and Video CD

Playback Setup **DVD** **VCD2.0** **VCD1.1**

- Turn on the TV and select the video input source connected to the DVD Receiver.
- Set the Output Source to CD/DVD as shown in Selecting the Output/Input Source on page 16.

1 Press **▲** to open the disc tray.

2 Place a disc on the tray, with the label facing up. When a double-sided DVD is inserted, make sure the side you want to play is facing down.

3 Press **▲** to close the tray. "READING" appears in the display window, and playback starts automatically. If playback does not start, press **▷** (PLAY). In some cases, the disc menu might appear instead.

If a menu screen is displayed

A menu screen may appear automatically after loading a DVD.

DVD

Use **◀/▶**/**▲/▼** buttons to select the title/chapter you want to view, then press ENTER to start playback.

Press DVD TOP MENU or DVD MENU to return to the menu screen.

VCD2.0

- Use the number buttons to select the track you want to view. Press RETURN to return to the menu screen.
- Menu setting and the exact operating procedures for using the menu may differ depending on the disc. Follow the instructions on the each menu screen. You also may set PBC to Off under setup. See page 20.

Notes

- If Parental Control is set and the disc is not within the Rating settings (not authorized), the 4-digit password must be entered and/or the disc must be authorized (see Parental Control, on page 21).
- DVDs may have a Region Code.
- Your DVD Receiver will not play discs that have a Region Code different from your DVD Receiver. The Region Code for this DVD Receiver is 4 (four).
- Do not keep a fixed image displayed on the screen for a long time.

General Features

Note

Unless stated otherwise, all operations described use the remote control. Some features may also be available on the Setup menu.

Resume Function **DVD** **VCD2.0** **VCD1.1** **CD**

When you stop the disc, the DVD remembers the point where you pressed **■** (STOP) and "RESUME **■**" appears on the TV screen. Press **▷** (PLAY) and play will resume from this point.

Tip

To play from the beginning of the disc, press **■** twice, then press **▷** (PLAY).

Notes

- Depending on where you stopped the disc, the receiver may not resume playback from exactly the same point.
- The point where you stopped playing is cleared when:
 - Press **■** in the STOP mode.
 - Turn the power off.
 - Open the disc tray.

Selecting Another TITLE **DVD** 1/3

If a disc has more than one title, you can select another title as follows:

- Press DVD DISPLAY. Use **▲/▼** to select title icon, then press the appropriate number buttons (0-9), then use ENTER to select a title number.
- Press DVD DISPLAY, then use **◀/▶** to select a title number, then press ENTER.

Selecting Another CHAPTER/TRACK

DVD **VCD2.0** **VCD1.1** 1/12 1/3

If a title on a disc has more than one chapter or a disc has more than one track, you can move to another chapter/track as follows:

- Press PREV or NEXT briefly during playback to return to the beginning of the current chapter/track or to select the next chapter/track.
- Press PREV twice briefly to step back to the previous chapter/track.
- To go directly to any chapter during playback, press DVD DISPLAY. Use **▲/▼** to select chapter/track icon. Then, enter the chapter/track number with the number buttons (0-9) or use **◀/▶** to select chapter. Then, press ENTER.

Notes

- For one-digit numbers, press the number buttons (1-9) and wait that the operation is performed.
- For two-digit numbers, press the number buttons (0-9) in rapid succession.
- On a Video CD with PBC, you must set PBC to Off on the setup menu to use this function. See page 20.

Search **DVD** **VCD2.0** **VCD1.1**

- 1 Press **◀◀** or **▶▶** during playback. The DVD Receiver will now go into SEARCH mode.
- 2 Press **◀◀** or **▶▶** repeatedly to select the required speed: X2 **◀**, 1 **◀◀**, 2 **◀◀**, 3 **◀◀** (backward) or X2 **▶**, 1 **▶▶**, 2 **▶▶**, 3 **▶▶** (forward). With a Video CD, the Search speed changes: 1 **◀◀**, 2 **◀◀**, 3 **◀◀** (backward) or 1 **▶▶**, 2 **▶▶**, 3 **▶▶** (forward).
- 3 To return to playback, press **▷** (PLAY).

Still Picture **DVD** **VCD2.0** **VCD1.1**

- 1 Press **||** (PAUSE) during playback. The DVD Receiver will go into PAUSE mode.
- 2 To return to playback, press or **||** (PAUSE) again or **▷** (PLAY).

General Features (Continued)

Slow Motion **DVD** **VCD2.0** **VCD1.1**

- 1 Press **II** (PAUSE) during playback. The DVD Receiver will now go into PAUSE mode.
- 2 Press **SLOW** **◀** or **▶** during pause mode. The DVD Receiver will enter SLOW mode.
- 3 Use **SLOW** **◀** or **▶** to select the required speed: 4 **◀**, 3 **◀**, 2 **◀** or 1 **◀** (backward), or 4 **▶**, 3 **▶**, 2 **▶** or 1 **▶** (forward).
- 4 To return to playback, press **▷** (PLAY).

Note

Slow motion playback in reverse is not applicable for Video CD.

Repeat **DVD** **VCD2.0** **VCD1.1**

DVD Video Discs - Repeat Chapter/Title/Off

- 1 Press **REPEAT** when playing a disc. The Repeat icon appears on the TV screen.
- 2 Press **REPEAT** to select a desired repeat mode.



- **CHAPT**: repeats the current chapter.
- **TITLE**: repeats the current title on a disc.
- **OFF**: does not play repeatedly.

Video CDs - Repeat Track/All/Off

- 1 Press **REPEAT** when playing a disc. The Repeat icon appears on the TV screen.
- 2 Press **REPEAT** to select a desired repeat mode.



- **TRACK**: repeats the current track
- **ALL**: repeats all the tracks on a disc.
- **OFF**: does not play repeatedly.

Notes

- On a Video CD with PBC, you must set PBC to Off on the setup menu to use the Repeat function. See page 20.
- When you press **PREV** twice or **NEXT** during Repeat mode to go to previous track or next track, repeat mode (Chapter repeat and Track repeat only) is canceled.

Time Search **DVD**

The Time Search function allows you to start playing at any chosen time on the disc.

- 1 Press **DVD DISPLAY** during playback. The on-screen display appears on the screen.

The Time Search box shows the elapsed playing time of the current disc.

- 2 Within 10 seconds, use **▲/▼** to select the Time Search icon in the on-screen display.

The “-:-:--” appears in the Time Search box.

- 3 Within 10 seconds, use the number buttons to enter the required start time. Enter hours, minutes and seconds from left to right in the box.

If you enter the wrong numbers, press **CLEAR** to remove the numbers you entered. Then enter the correct numbers.

- 4 Within 10 seconds, press **ENTER**.

Playback starts from the selected time on the disc. If you enter an invalid time, playback will continue from the current point.

General Features (Continued)

Special DVD Features

Checking the contents of DVD Video discs: Menus

A DVD is divided into a lot of sections, which make up a picture or music feature. These sections are called "titles." When you play a DVD which contains several titles, you can select the title you want using DVD TOP MENU.

When you play DVDs that allow you to select items such as the language for the sound, select these items using DVD MENU.

- 1 Press DVD TOP MENU or DVD MENU.
The disc's menu appears on the TV screen.
The contents of the menu vary from disc to disc.
- 2 Press / / / or the number buttons to select the item you want to play or change.
- 3 Press ENTER.

Camera Angle

If the disc contains sequences recorded from different camera angles, the angle icon appears on the TV screen. You can then change the camera angle if you wish.

- Press ANGLE repeatedly during playback to select a desired angle.
The number of the current angle appears on the display.

Changing the Audio Language



Press AUDIO repeatedly during playback to hear a different audio language or audio track.

Changing the Audio Channel

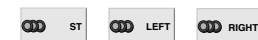

Press AUDIO repeatedly during playback to hear a different audio channel (ST, LEFT or RIGHT).

Subtitle

Press SUBTITLE repeatedly during playback to see the different subtitle languages.

Note

If appears, the feature is not available on the disc.

Audio CD and MP3 Disc Operation

Playing an Audio CD and MP3

Disc **CD** **MP3**

The DVD Receiver can play MP3 formatted recordings on CD-ROM, CD-R or CD-RW discs. Before playing MP3 disc, read the notes on MP3 files on right.

1 Insert a disc and close the tray.

Audio CD: Audio CD menu appears on the TV screen go to step 4.

MP3 disc: The MP3/JPEG select menu appears on the TV screen. Go to step 2



2 Use \uparrow/\downarrow to select the MP3 then press ENTER.

The MP3 disc Menu appears on the TV screen. Press RETURN to move to the MP3/JPEG select menu.

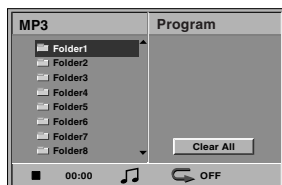

3 Use \uparrow/\downarrow to select a folder, and ENTER.

A list of files in the folder appears.

If a list of files contains another folder, repeat step 3 once more.

Tip

If you are in a file list and want to return to the Folder list, use the \uparrow/\downarrow to highlight \square and press ENTER to return to the previous menu screen.

4 Use \uparrow/\downarrow to select a track then press \triangleright (PLAY) or ENTER.

Playback starts.

During playback, the current track's elapsed playing time will appear in the display window and menu.

Playback will stop at the end of the disc.

Press DVD TOP MENU to move to the next page.

Press DVD MENU to move to the previous page.

Audio CD Menu

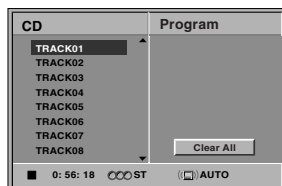

MP3 disc Menu

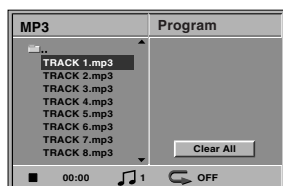

5 Press \blacksquare (STOP) to stop playback.

Notes on MP3 Files

About MP3

- An MP3 file is audio data compressed by using the MPEG1 audio layer-3 file-coding scheme. We call files that have the ".mp3" file extension "MP3 files".
- The DVD Receiver can not read an MP3 file that has a file extension other than ".mp3".

MP3 Disc compatibility with this DVD Receiver is limited as follows:

- Sampling Frequency : only at 44.1kHz
- Bit rate : within 32 - 320kbps
- CD-R physical format should be "ISO 9660"
- If you record MP3 files using the software which cannot create a FILE SYSTEM, it is impossible to playback MP3 files.
- A single session disc requires MP3 files in the first track. If there is no MP3 file in the 1st track, it cannot playback MP3 files. If you wish to playback MP3 files, format all the data in the disc or use a new one.
- File names should be named using 8 letters or less and must incorporate ".mp3" extension e.g. "*****.mp3".
- Do not use special letters such as "/ : * ? < > " etc.
- Total number of files on the disc should be less than 650.

This DVD Receiver requires discs/recordings to meet certain technical standards in order to achieve optimal playback quality. Pre-recorded DVDs are automatically set to these standards. There are many different types of recordable disc formats (including CD-R containing MP3 files). That require certain pre-existing conditions (see above) to insure compatible playback.

Customers should also note that permission is required in order to download MP3 files and music from the Internet. Our company has no right to grant such permission. Permission should always be sought from the copyright owner.

Audio CD and MP3 Disc Operation (Continued)

Pause **CD** **MP3**

- 1 Press **II** (PAUSE) during playback.
- 2 To return to playback, press **II** (PAUSE) again or press **▷** (PLAY).

Selecting Another Track **CD** **MP3**

If a disc has more than one track, you can move to another track as follows:

- Press **I◀◀** or **▶▶I** briefly during playback to go to the next track or to return to the beginning of the current track.
- Press **I◀◀** twice briefly to step back to the previous track.
- On Audio CDs, to go directly to any track, enter the track number using the number buttons (0-9) during playback.

Notes

- For one-digit numbers, press the number buttons (1-9) and wait that the operation is performed.
- For two-digit numbers, press the number buttons (0-9) in rapid succession.

Search **CD** **MP3**

- 1 Press **◀◀** or **▶▶** during playback.
The DVD Receiver will now go into SEARCH mode.
- 2 Press **◀◀** or **▶▶** repeatedly to select the required speed: 1 **◀◀**, 2 **◀◀**, 3 **◀◀** (backward) or 1 **▶▶**, 2 **▶▶**, 3 **▶▶** (forward).
Search speed and direction are indicated on the menu screen.
- 3 To return to playback, press **▷** (PLAY).

Repeat **CD** **MP3**

- 1 Press REPEAT when playing a disc.
The Repeat icon appears on the TV screen.
- 2 Press REPEAT to select a desired repeat mode.



- TRACK: repeats the current track
- ALL: repeats all the tracks on a disc.
- OFF: does not play repeatedly.

Note

When you press **I◀◀** twice or **▶▶I** during Repeat mode to go to previous track or next track, repeat mode (Track repeat only) is canceled.

Changing the Audio Channel **CD**

Press AUDIO repeatedly during playback to hear a different audio channel (ST, LEFT, or RIGHT).

JPEG File Operation

Viewing JPEG Files on a Disc **JPEG**

This DVD Receiver can play discs with JPEG files. Before playing JPEG files, read the notes on JPEG Files on right.

- 1 Insert a disc and close the tray.**
The MP3/JPEG select menu appears on the TV screen.

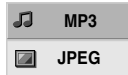

- 2 Use \uparrow/\downarrow to select the JPEG then press ENTER.**
The JPEG menu appears on the TV screen.



- 3 Use \uparrow/\downarrow to select a folder, and ENTER.**
A list of files in the folder appears.
Press RETURN to move to the MP3/JPEG select menu.

Tip

If you are in a file list and want to return to the Folder list, use the \uparrow/\downarrow buttons on the remote to highlight “ \dots ” and press ENTER to return to the previous menu screen.

- 4 Use \uparrow/\downarrow to select a file then press ENTER or \triangleright (PLAY).**
Viewing the file function starts.
While viewing a file, press RETURN to move to the previous menu (JPEG menu).
Press DVD TOP MENU to move to the next page.
Press DVD MENU to move to the previous page.

Note
JPEG file that does not play is skipped.

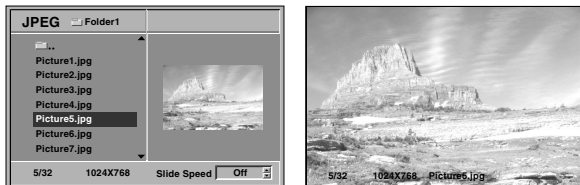

Tip

There are three viewing Slide Speed options: Fast, Normal, Slow, and Off. Use \leftarrow/\rightarrow to highlight the Slide Speed then use \uparrow/\downarrow to select the option you want to use, and press ENTER.

- 5 Press \blacksquare (STOP) to stop viewing.**
The JPEG menu appears.

Selecting another Files

Press \lll or \ggg once while viewing a picture to advance to the next file or to the previous file.

Still Picture

- Press $\|\|$ (PAUSE) during slide show.
The DVD Receiver will now go into PAUSE mode.
- To return to the slide show, press \triangleright (PLAY) or $\|\|$ (PAUSE) again.

To flip the picture

Press \uparrow/\downarrow while showing a picture to flip the picture horizontally or a vertically.

To rotate picture

Press \leftarrow/\rightarrow while showing a picture to rotate the picture clockwise or counter clockwise.

Notes on JPEG Files

- Depending upon the size and number of the JPEG files, it could take a long time for the DVD Receiver to read the disc's contents. If you don't see an on-screen display after several minutes, some of the files are too big — reduce the resolution of the JPEG files to less than 2 mega pixels and burn another disc.
- Total number of files and folders on the disc should be less than 650.
- Some disc may be incompatible due to different recording format or condition of disc.
- When you are using software to burn the jpeg files into the CD-R, ensure that all the selected files have the “.jpg” extensions when copying into the CD layout.
- If the files have “.jpe” or “.jpeg” extensions, please rename them as “.jpg” files.
- File names without “.jpg” extension will not be able to be read by this DVD Receiver, even though the files are shown as JPEG image files in windows explorer.

Programmed Playback with Audio CD and MP3 Disc

The Program function enables you to store your favorite tracks from any disc in the DVD Receiver memory.

Program can contain 30 tracks.

1 Press PROGRAM to enter the Program Edit mode.

The  mark will appear to the right of the word Program on the right side of the menu screen.

Note
Press PROGRAM to exit the Program Edit mode; the  mark will disappear.

2 Select a track, then press ENTER to place the selected track on the Program list.

3 Repeat step 2 to place additional tracks on the Program list.

Audio CD menu

MP3 disc Menu

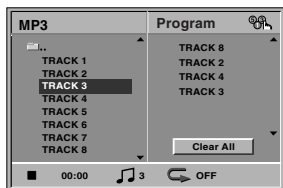
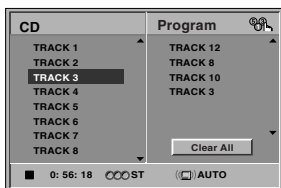

4 Press →.

The programmed track you selected last is highlighted on the program list.

5 Press ↑/↓ to select the track you want to start playing.

Press DVD TOP MENU to move to the next page.
Press DVD MENU to move to the previous page.

6 Press ▷ (PLAY) or ENTER to start.

Playback begins in the order in which you programmed the tracks and "PGM" appears on the menu screen. Playback stops after all of the tracks on the Program list have played once.

7 To return normal playback from programmed playback, press PROGRAM to exit the Program Edit mode. Select a track of CD (or MP3) list and then press ENTER or ▷ (PLAY).

"PGM" indicator disappears in the display window.

Programmed Playback with Video CD

Note

On a Video CD with PBC, you must set PBC to Off on the setup menu to use the Program function. See page 20.

1 Insert Video CD and close the tray.

2 Press PROGRAM.

The VCD Program menu will appear.

Note

Press RETURN, PROGRAM or ▷ (PLAY) to exit the Program menu.

3 Follow steps 2-6 of "Programmed Playback with Audio CD and MP3 disc" on left.

"PROGRAM" appears on the TV screen.

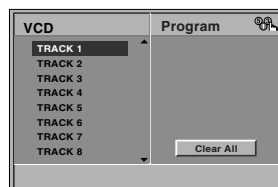

4 To return normal playback from programmed playback, press PROGRAM.

"PROGRAM" disappears on the TV screen.

Repeat Programmed Tracks

1 Press REPEAT when playing the programmed tracks.

The Repeat icon appears on the TV screen.

2 Press REPEAT to select a desired repeat mode.



- TRACK: repeats the current track
- ALL: repeats all tracks on the program list.
- OFF: does not play repeatedly.

Erasing a Track from Program List

1 Press PROGRAM during playback (Audio CD and MP3 disc only) or stop to enter the Program Edit mode.

The  mark will appear.

2 Press → to move to the Program list.

3 Use ↑/↓ to select the track that you wish to erase from the Program list.

4 Press CLEAR.

The track will be erased from the Program list.

Erasing the whole Program List

1 Follow steps 1-2 of "Erasing a Track from Program List" as above.

2 Use ↑/↓ to select "Clear All", then press ENTER.

The complete Program for the disc will be erased.

Notes

- The programs are cleared when the power is turn off.
- The programs are cleared when the disc is removed.
- The programs are cleared when another function mode (VIDEO, FM, AM etc.,) is selected.

Speaker Setup

You can set your personal preferences on the DVD function mode.

Adjust the following settings for the built-in 5.1 channel surround decoder.

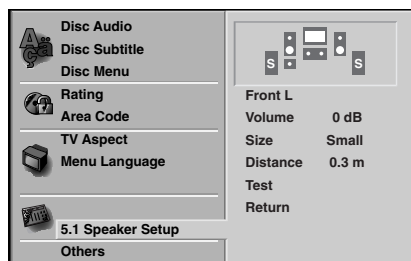

1 Press DVD SETUP.

The Setup menu appears.

2 Select "5.1 Speaker Setup" using the \uparrow/\downarrow buttons on the setup menu.

3 While "5.1 Speaker Setup" is selected, press \rightarrow button.

4 Press \rightarrow buttons to select the desired speaker.

5 Adjust options by using $\uparrow/\downarrow/\leftarrow/\rightarrow$ buttons.

Speaker selection

Select a speaker that you want to adjust. ((Front speaker (Left), Front speaker (Right), Center Speaker, Surround speaker (Left), Surround speaker (Right), or Subwoofer))

Note

Certain speaker settings are prohibited by the Dolby Digital licensing agreement.

Volume

Press \leftarrow/\rightarrow to adjust the output level of the selected speaker. (-6dB ~ 6dB)

Size

Since the speaker settings are fixed, you cannot change the settings.

- Subwoofer's size is fixed "Large" and the other speaker's size are fixed "Small".

Distance

If you connected speakers to your DVD Receiver, setting the Distance lets the speakers (except subwoofer) know how far the sound has to travel to reach your set listening point. This allows the sound from each speaker to reach the listener at the same time.

Note

You can not set the distance of subwoofer speaker.

Test

Press ENTER to test the signals of each speaker. Adjust the volume to match the volume of test signals memorized in the system.

- Front L (Left) \rightarrow Center \rightarrow Front R (Right) \rightarrow SURROUND R (Right) \rightarrow SURROUND L (Left) \rightarrow Sub woofer

You can stop the test using \uparrow/\downarrow .

Note

This function is not available when microphone plug into the MIC socket.

Return

Press ENTER to return to the previous menu.

Additional Information

Sleep Timer Setting

You can set the DVD Receiver to turn off automatically at a specified time.

- 1 Press SLEEP to set the desired sleep time.**
The SLEEP indicator and sleep time appears in the display window.
- 2 Each time you press SLEEP the setting changes in the following order.**
SLEEP 90 → 80 → 70 → 60 → 50 → 40 → 30 → 20 → 10 → OFF

Note

- **You can check the time remaining before the DVD Receiver turns off.**
Press SLEEP. The remaining time appears in the Display Window.

Viewing the Playing Time and Remaining Time in the Front Panel Display

Display

You can check the disc information, such as the remaining time, total number of titles in a DVD, or tracks in a CD, VIDEO CD or MP3, using the front panel display.

Press DISPLAY on the remote.

Each time you press DISPLAY while playing the disc, the display changes.

Notes

- Depending on the type of disc being played and the playing mode, the disc information may not be displayed.
- This function is available during only playback mode.

Tips

- When playing VIDEO CDs with PBC functions, only the playing time of the scene is displayed.
- The playing time and remaining time of the current chapter, title, track, scene, or disc will also appear on your TV screen.

Dimmer

This function will change the brightness of the display window on the front panel during in power-on status.

Press the DIMMER repeatedly.

Muting

Press MUTING to mute your unit.

You can mute your unit in order, for example, to answer the telephone, "MUTING ON" indicator in the Display Window. To exit mute mode, press MUTING again.

Using Headphone Jack

Connect a stereo headphone plug (ø3.5mm) into the **PHONES connector**.

The speakers are automatically disconnected when you plug in a headphone (not supplied).

Volume Control

You can adjust the volume by turning VOLUME (-/+) repeatedly.

Using the Sound Effect

This system provides you with sound effect, simply by pressing a button. Choose sound to suit your needs.

Press BASS on the remote.

The sound effect is activate.

● **BASS**

With BASS on, bass frequencies are effectively reinforced.

To turn off the sound effect

Press BASS on the remote again.

Notes

- When you connect headphones to the system, the BASS function does not work.
- This function is available during only playback mode.

Using the Karaoke Function

- 1** Load a karaoke disc.
- 2** Set the MIC VOL control to the minimum level to prevent acoustic feedback (e.g. a loud howling sound) before connecting the microphone.
- 3** Connect a microphone to MIC socket. (ø3.5mm).
- 4** Press **PLAY** to start playback.
- 5** Adjust MIC VOL control and then sing a song.
If you want to set KARAOKE option follow steps 6-8.
- 6** Press **KARAOKE** during playback. KARAOKE menu appears.
- 7** Use **▲▼** to select an desired item (**ECHO**, **KEY**, **VOICE**, **MELODY** or **EFFECT**).
The display changes as shown in the chart below.

(DVD Karaoke Disc)

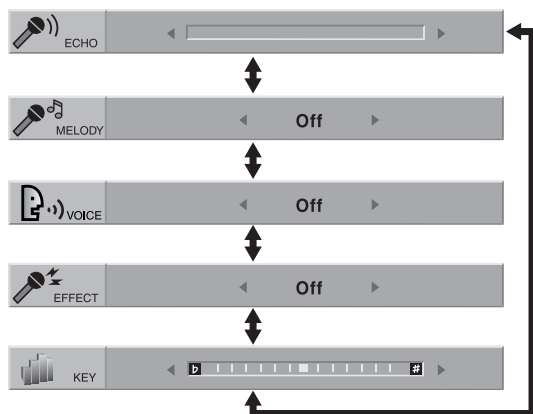

(VCD Karaoke Disc)

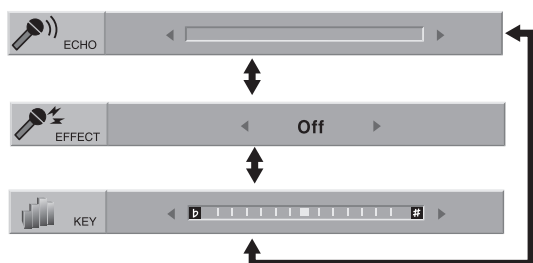

8 Use **◀▶** to adjust value of the item selected.

ECHO: You can adjust the echo volume by pressing the **◀▶** buttons.

MELODY: If you wish to sing only to the backing band or orchestra unaccompanied by a vocal guide melody, set MELODY to Off.

VOICE: If you wish to sing a duet with the recorded karaoke singer, select a voice you desire.

V1+V2 → off (None Voice) → V1 → V2

EFFECT: You can use Special Effects. Each time **◀▶** is pressed, the Special Effect changes as shown below.

Off → HARMONY → FLANGE → CHORUS

KEY: You can change the key by pressing the **◀▶** buttons.

9 Press **KARAOKE** to exit the **KARAOKE** menu.

N Notes

- The microphone may not be available during special playback. (ex. slow)
- The karaoke feature functions only with karaoke-compatible discs.
- The VOICE and MELODY menus may not be available on some karaoke discs.
- The ECHO, EFFECT and KEY function may be operated on CD, other disc (except DVD disc) and external input source (Analogue).
- When you using a microphone, the signal is output from the Front L/R speakers.
- For more details, refer to the information supplied with the disc.

Presetting the Radio stations

You can preset 30 stations for FM and AM (MW). Before tuning, make sure that you have turned down the volume.

1 Press **TUNER/BAND** on the remote control until **FM** or **AM (MW)** appears in the display window.

2 And then every time you press **TUNER/BAND**, **FM** and **AM (MW)** changes alternately.

3 Press and hold **TUNING -** or **+** on the remote control for about two seconds until the frequency indication starts to change, then release.

Scanning stops when the DVD/CD Receiver tunes in a station. "TUNED" and "ST" (for stereo program) appear in the Display Window.

4 Press **TUNER MENU** on the remote control. A preset number will flash in the Display Window.

5 Press **TUNING -** or **+** on the remote control to select the preset number you want.

6 Press **TUNER MENU** on the remote control again. The station is stored.

7 Repeat steps 3 to 6 to store other stations.

To tune in a station with a weak signal

Press **TUNING -** or **+** repeatedly in step 3 to tune in the station manually.

To clear all the stored stations

Press and hold **TUNER MENU** for about two seconds and "CLEAR ALL" is appeared in the display window and then press **TUNER MENU** again, the stations are cleared.

- If you have accidentally entered into the "CLEAR ALL" mode and you do not wish to clear the memory, do not press any key. After a few seconds, the "CLEAR ALL" display will go off by itself and change to normal mode.

Note

If all stations have already been entered, the FULL message will appear in the display window for a moment and then a preset number will flash.

To change the preset number, follow the steps 5-6 as above.

Listening to the Radio

Preset radio stations in the DVD Receiver's memory first (see "Presetting radio stations" on the left).

1 Press **TUNER/BAND** until **AM (MW)** or **FM** appears in the Display Window.

The last received station is tuned in.

2 Press **PRESET +/-** repeatedly to select the preset station you want.

Each time you press the button, the DVD receiver tunes in one preset station at a time.

3 Adjust the volume by pressing **VOLUME +** or **-** repeatedly.

To turn off the radio

Press **I / ⏻** to turn the DVD Receiver off or select another function mode (CD/DVD or VIDEO).

To listen to non-preset radio stations

- Use manual or automatic tuning in step 2.
- For manual tuning, press **TUNING -** or **+** on the remote control repeatedly.
- For automatic tuning, press and hold **TUNING -** or **+** for about two seconds on the remote control.

To select a preset radio station directly

You can use the number buttons on the remote control to select a preset radio station directly.

For example, to listen to preset station 4, press 4 on the remote control. To listen to preset station 19, press 1 then 9 (within 3 seconds).

For your reference

● If an FM program is noisy

Press **FM MODE** on the remote control so that "ST" disappears in the display window. There will be no stereo effect, but the reception will improve. Press **FM MODE** again to restore the stereo effect.

● To improve reception

Reorient the supplied antennas.

Controlling the TV with the Supplied Remote

You can control the sound level, input source, and power switch of your TV with the supplied remote.

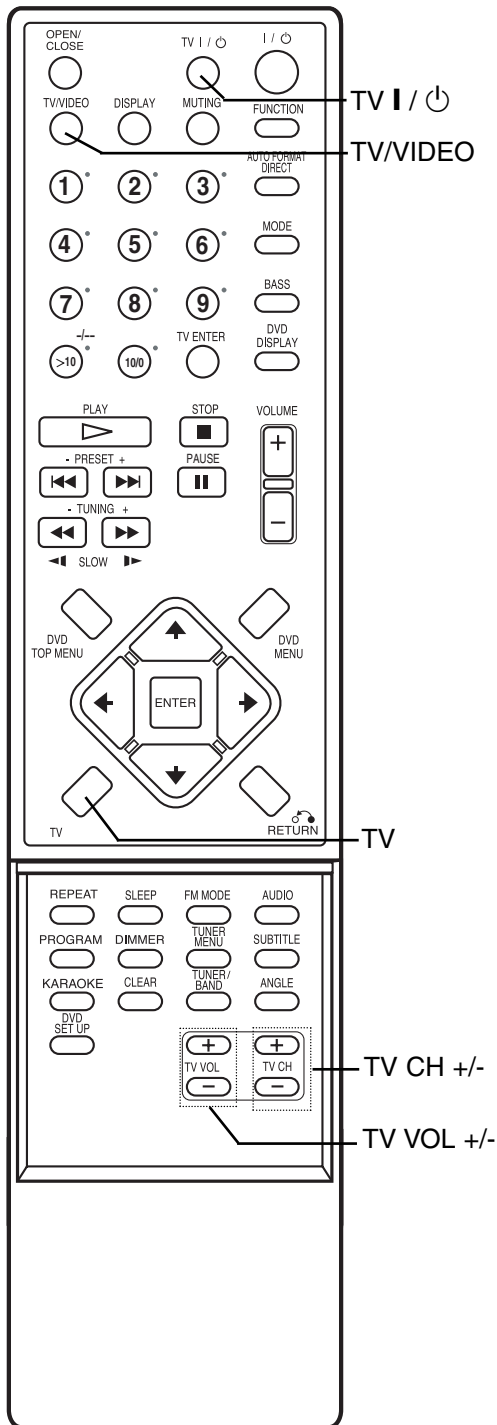

Controlling the TV

You can control your TV using the buttons below.

By pressing	You can
TV I / ⏻	Turn the TV on or off.
TV/VIDEO	Switch the TV's input source between the TV and other input sources.
TV CH +/-	Scans up or down through memorized channels.
TV VOL +/-	Adjust the volume of the TV.

Using the number buttons for controlling the TV

When you set the remote to the TV mode, you can use the number buttons for controlling the TV.

Press the TV buttons

The TV button turns red and the remote is set to the TV mode. You can select the TV channels by using the number buttons.

>10 is for selecting the channel number greater than 10. To cancel the TV mode, press the TV button again.

Notes

- Before adjusting the TV, press TV.
- The TV button turns off when you do not operate the remote for 10 seconds.
- Depending on the TV, you may not be able to control your TV or to use some of the buttons above.

Tip

Depending on the TV manufacture, the following method works. For double-digit number, press -/-- first and then number. (For example, for channel 25, press -/--, then 2 and 5.)

Language Code List

Enter the appropriate code number for the initial settings “Disc Audio”, “Disc Subtitle” and/or “Disc Menu” (See page 19).

Code	Language	Code	Language	Code	Language	Code	Language
6566	Abkhazian	7074	Fiji	7678	Lingala	8373	Singhalese
6565	Afar	7073	Finnish	7684	Lithuanian	8375	Slovak
6570	Afrikaans	7082	French	7775	Macedonian	8376	Slovenian
8381	Albanian	7089	Frisian	7771	Malagasy	8379	Somali
6577	Ameharic	7176	Galician	7783	Malay	6983	Spanish
6582	Arabic	7565	Georgian	7776	Malayalam	8385	Sudanese
7289	Armenian	6869	German	7784	Maltese	8387	Swahili
6583	Assamese	6976	Greek	7773	Maori	8386	Swedish
6588	Aymara	7576	Greenlandic	7782	Marathi	8476	Tagalog
6590	Azerbaijani	7178	Guarani	7779	Moldavian	8471	Tajik
6665	Bashkir	7185	Gujarati	7778	Mongolian	8465	Tamil
6985	Basque	7265	Hausa	7865	Nauru	8484	Tatar
6678	Bengali; Bangla	7387	Hebrew	7869	Nepali	8469	Telugu
6890	Bhutani	7273	Hindi	7879	Norwegian	8472	Thai
6672	Bihari	7285	Hungarian	7982	Oriya	6679	Tibetan
6682	Breton	7383	Icelandic	8065	Panjabi	8473	Tigrinya
6671	Bulgarian	7378	Indonesian	8083	Pashto, Pushto	8479	Tonga
7789	Burmese	7365	Interlingua	7065	Persian	8482	Turkish
6669	Byelorussian	7165	Irish	8076	Polish	8475	Turkmen
7577	Cambodian	7384	Italian	8084	Portuguese	8487	Twi
6765	Catalan	7465	Japanese	8185	Quechua	8575	Ukrainian
9072	Chinese	7487	Javanese	8277	Rhaeto-Romance	8582	Urdu
6779	Corsican	7578	Kannada	8279	Rumanian	8590	Uzbek
7282	Croatian	7583	Kashmiri	8285	Russian	8673	Vietnamese
6783	Czech	7575	Kazakh	8377	Samoan	8679	Volapük
6865	Danish	7589	Kirghiz	8365	Sanskrit	6789	Welsh
7876	Dutch	7579	Korean	7168	Scots Gaelic	8779	Wolof
6978	English	7585	Kurdish	8382	Serbian	8872	Xhosa
6979	Esperanto	7679	Laothian	8372	Serbo-Croatian	7473	Yiddish
6984	Estonian	7665	Latin	8378	Shona	8979	Yoruba
7079	Faroese	7686	Latvian, Lettish	8368	Sindhi	9085	Zulu

Area Code List

Enter the appropriate code number for the initial setting "Area Code" (See page 21).

Code	Area	Code	Area	Code	Area	Code	Area
AD	Andorra	ER	Eritrea	LC	Saint Lucia	SC	Seychelles
AE	United Arab Emirates	ES	Spain	LI	Liechtenstein	SD	Sudan
AF	Afghanistan	ET	Ethiopia	LK	Sri Lanka	SE	Sweden
AG	Antigua and Barbuda	FI	Finland	LR	Liberia	SG	Singapore
AI	Anguilla	FJ	Fiji	LS	Lesotho	SH	Saint Helena
AL	Albania	FK	Falkland Islands	LT	Lithuania	SI	Slovenia
AM	Armenia	FM	Micronesia	LU	Luxembourg	SJ	Svalbard and Jan Mayen Islands
AN	Netherlands Antilles	FO	Faroe Islands	LV	Latvia	SK	Slovak Republic
AO	Angola	FR	France	LY	Libya	SL	Sierra Leone
AQ	Antarctica	FX	France (European Territory)	MA	Morocco	SM	San Marino
AR	Argentina	GA	Gabon	MC	Monaco	SN	Senegal
AS	American Samoa	GB	Great Britain	MD	Moldavia	SO	Somalia
AT	Austria	GD	Grenada	MG	Madagascar	SR	Suriname
AU	Australia	GE	Georgia	MH	Marshall Islands	ST	Saint Tome and Principe
AW	Aruba	GF	French Guyana	MK	Macedonia	SU	Former USSR
AZ	Azerbaijan	GH	Ghana	ML	Mali	SV	El Salvador
BA	Bosnia-Herzegovina	GI	Gibraltar	MM	Myanmar	SY	Syria
BB	Barbados	GL	Greenland	MN	Mongolia	SZ	Swaziland
BD	Bangladesh	GM	Gambia	MO	Macau	TC	Turks and Caicos Islands
BE	Belgium	GN	Guinea	MP	Northern Mariana Islands	TD	Chad
BF	Burkina Faso	GP	Guadeloupe (French)	MQ	Martinique (French)	TF	French Southern Territories
BG	Bulgaria	GQ	Equatorial Guinea	MR	Mauritania	TG	Togo
BH	Bahrain	GR	Greece	MS	Montserrat	TH	Thailand
BI	Burundi	GS	S. Georgia & S. Sandwich Isls.	MT	Malta	TJ	Tadjikistan
BJ	Benin	GT	Guatemala	MU	Mauritius	TK	Tokelau
BM	Bermuda	GU	Guam (USA)	MV	Maldives	TM	Turkmenistan
BN	Brunei Darussalam	GW	Guinea Bissau	MW	Malawi	TN	Tunisia
BO	Bolivia	GY	Guyana	MX	Mexico	TO	Tonga
BR	Brazil	HK	Hong Kong	MY	Malaysia	TP	East Timor
BS	Bahamas	HM	Heard and McDonald Islands	NA	Namibia	TR	Turkey
BT	Bhutan	HN	Honduras	NC	New Caledonia (French)	TT	Trinidad and Tobago
BV	Bouvet Island	HR	Croatia	NE	Niger	TV	Tuvalu
BW	Botswana	HT	Haiti	NF	Norfolk Island	TW	Taiwan
BY	Belarus	HU	Hungary	NG	Nigeria	TZ	Tanzania
BZ	Belize	ID	Indonesia	NI	Nicaragua	UA	Ukraine
CA	Canada	IE	Ireland	NL	Netherlands	UG	Uganda
CC	Cocos (Keeling) Islands	IL	Israel	NO	Norway	UK	United Kingdom
CF	Central African Republic	IN	India	NP	Nepal	UM	USA Minor Outlying Islands
CG	Congo	IO	British Indian Ocean Territory	NR	Nauru	US	United States
CH	Switzerland	IQ	Iraq	NU	Niue	UY	Uruguay
CI	Ivory Coast	IR	Iran	NZ	New Zealand	UZ	Uzbekistan
CK	Cook Islands	IS	Iceland	OM	Oman	VA	Vatican City State
CL	Chile	IT	Italy	PA	Panama	VC	Saint Vincent & Grenadines
CM	Cameroon	JM	Jamaica	PE	Peru	VE	Venezuela
CN	China	JO	Jordan	PF	Polynesia (French)	VG	Virgin Islands (British)
CO	Colombia	JP	Japan	PG	Papua New Guinea	VI	Virgin Islands (USA)
CR	Costa Rica	KE	Kenya	PH	Philippines	VN	Vietnam
CS	Former Czechoslovakia	KG	Kyrgyzstan	PK	Pakistan	VU	Vanuatu
CU	Cuba	KH	Cambodia	PL	Poland	WF	Wallis and Futuna Islands
CV	Cape Verde	KI	Kiribati	PM	Saint Pierre and Miquelon	WS	Samoa
CX	Christmas Island	KM	Comoros	PN	Pitcairn Island	YE	Yemen
CY	Cyprus	KN	Saint Kitts & Nevis Anguilla	PR	Puerto Rico	YT	Mayotte
CZ	Czech Republic	KP	North Korea	PY	Paraguay	YU	Yugoslavia
DE	Germany	KR	South Korea	QA	Qatar	ZA	South Africa
DJ	Djibouti	KW	Kuwait	RE	Reunion (French)	ZM	Zambia
DK	Denmark	KY	Cayman Islands	RO	Romania	ZR	Zaire
DM	Dominica	KZ	Kazakhstan	RU	Russian Federation	ZW	Zimbabwe
DO	Dominican Republic	LA	Laos	RW	Rwanda		
DZ	Algeria	LB	Lebanon	SA	Saudi Arabia		
EC	Ecuador			SB	Solomon Islands		
EE	Estonia						
EG	Egypt						
EH	Western Sahara						

Troubleshooting

Check the following guide for the possible cause of a problem before contacting service.

Symptom	Cause	Correction
No power.	<ul style="list-style-type: none"> The power cord is disconnected. 	<ul style="list-style-type: none"> Plug the power cord securely into the wall outlet.
The power is on, but the DVD Receiver does not work.	<ul style="list-style-type: none"> No disc is inserted. 	<ul style="list-style-type: none"> Insert a disc. (Check that the DVD or, audio CD indicator in the DVD display is lit.)
No picture.	<ul style="list-style-type: none"> The TV is not set to receive DVD signal output. 	<ul style="list-style-type: none"> Select the appropriate video input mode on the TV so the picture from the DVD/ CD receiver appears on the TV screen.
	<ul style="list-style-type: none"> The video cable is not connected securely. 	<ul style="list-style-type: none"> Connect the video cable into the jacks securely.
	<ul style="list-style-type: none"> The connected TV power is turned off. 	<ul style="list-style-type: none"> Turn on the TV.
There is no sound or only a very low-level sound is heard.	<ul style="list-style-type: none"> The equipment connected with the audio cable is not set to receive DVD signal output. 	<ul style="list-style-type: none"> Select the correct input mode of the audio receiver so you can hear the sound from the DVD Receiver.
	<ul style="list-style-type: none"> The audio cables are not connected securely. 	<ul style="list-style-type: none"> Connect the audio cable into the jacks securely.
	<ul style="list-style-type: none"> The power of the equipment connected with the audio cable is turned off. 	<ul style="list-style-type: none"> Turn on the equipment connected with the audio cable.
	<ul style="list-style-type: none"> The audio connecting cable is damaged. 	<ul style="list-style-type: none"> Replace it with new one.
The playback picture is poor.	<ul style="list-style-type: none"> The disc is dirty. 	<ul style="list-style-type: none"> Clean the disc.
The DVD Receiver does not start playback.	<ul style="list-style-type: none"> No disc is inserted. 	<ul style="list-style-type: none"> Insert a disc. (Check that the DVD, or audio CD indicator in the DVD display is lit.)
	<ul style="list-style-type: none"> An unplayable disc is inserted. 	<ul style="list-style-type: none"> Insert a playable disc. (Check the disc type, colour system and Regional code.)
	<ul style="list-style-type: none"> The disc is placed upside down. 	<ul style="list-style-type: none"> Place the disc with the playback side down.
	<ul style="list-style-type: none"> The disc is not placed within the guide. 	<ul style="list-style-type: none"> Place the disc on the disc tray correctly inside the guide.
	<ul style="list-style-type: none"> The disc is dirty. 	<ul style="list-style-type: none"> Clean the disc.
	<ul style="list-style-type: none"> A menu is on the TV screen. 	<ul style="list-style-type: none"> Press the DVD SETUP button to turn off the menu screen.
	<ul style="list-style-type: none"> The Rating level is set. 	<ul style="list-style-type: none"> Cancel the Rating function or change the rating level.
Loud hum or noise is heard.	<ul style="list-style-type: none"> The plugs and jacks are dirty. 	<ul style="list-style-type: none"> Wipe them with a cloth slightly moistened with alcohol.
	<ul style="list-style-type: none"> The disc is dirty. 	<ul style="list-style-type: none"> Clean the disc.
	<ul style="list-style-type: none"> The speakers and components are connected poorly. 	<ul style="list-style-type: none"> Connect the speakers and components securely.
	<ul style="list-style-type: none"> The DVD Receiver is located too close to the TV. 	<ul style="list-style-type: none"> Move your TV away from the audio components.

Troubleshooting (Continued)

Symptom	Cause	Correction
Radio stations cannot be tuned in.	<ul style="list-style-type: none"> The antenna is positioned or connected poorly. 	<ul style="list-style-type: none"> Connect the antenna securely. Adjust the antennas and connect an external antenna if necessary.
	<ul style="list-style-type: none"> The signal strength of the stations is too weak (when tuning in with automatic tuning). 	<ul style="list-style-type: none"> Tune in the station manually.
	<ul style="list-style-type: none"> No stations have been preset or preset stations have been cleared (when tuning by scanning preset stations). 	<ul style="list-style-type: none"> Preset the stations (page 32).
The remote control does not work properly.	<ul style="list-style-type: none"> The remote control is not pointed at the remote sensor of the DVD Receiver. 	<ul style="list-style-type: none"> Point the remote control at the remote sensor of the DVD Receiver.
	<ul style="list-style-type: none"> The remote control is too far from the DVD Receiver. 	<ul style="list-style-type: none"> Use the remote control within about 20 ft (6 m).
	<ul style="list-style-type: none"> There is an obstacle in the path of the remote control and the DVD/CD receiver. 	<ul style="list-style-type: none"> Remove the obstacle.
	<ul style="list-style-type: none"> The batteries in the remote control are flat. 	<ul style="list-style-type: none"> Replace the batteries with new ones.
The sound mode or Pro Logic II mode cannot be changed.	<ul style="list-style-type: none"> The system cannot change while playing a MP3 disc. 	<ul style="list-style-type: none"> Insert such a CD disc.
The front panel display is too dim.	<ul style="list-style-type: none"> Nothing is displayed on the front panel display. 	<ul style="list-style-type: none"> Press DIMMER on the remote control.

Specification

[General]	Power supply	220-240V AC, 50/60Hz	
	Power consumption	70W, No more than 1 W (220-240V AC) (at the power saving mode)	
	Mass	4.7 kg	
	External dimensions (WxHxD)	430 x 70 x 370.5 mm	
	Operating conditions	Temperature: 5°C to 35°C, Operation status: Horizontal	
	Operating humidity	5% to 85%	
[CD/DVD]	Laser	Semiconductor laser, wavelength 650 nm for VCD and DVD, wavelength 780 nm for CD	
	Emission duration	Continuous	
	Signal system	PAL/NTSC	
	Frequency response (audio)	2 Hz ~ 20 kHz (± 1.0 dB)	
	Signal-to-noise ratio (audio)	More than 75 dB (1 kHz, NOP, 20 kHz LPF/A-Filter)	
	Dynamic range (audio)	More than 70 dB	
	Harmonic distortion (audio)	0.5 % (1 kHz, at 12W position) (20 kHz LPF/A-Filter)	
[Video]	Inputs	VIDEO (AUDIO IN): Sensitivity: 800 m V Impedance: 50 kilohms	MIC (phone jacks) Sensitivity: 4 m V Impedance: 10 kilohms
	Video output	1.0 V (p-p), 75 Ω , negative sync., RCA jack	
	S VIDEO OUT	(Y) 1.0 V (p-p), 75 Ω , negative sync, Mini DIN 4-pin x 1 (C) 0.286 V (p-p) 75 Ω	
	COMPONENT VIDEO OUT	(Y) 1.0 V (p-p), 75 Ω , negative sync, RCA jack x 1 (PB/CB)/(PR/CR) 0.7 V (p-p), 75 Ω , RCA jack x 2	
[Tuner]	[FM]	Tuning Range	87.5 - 108 MHz
		Intermediate Frequency	10.7 MHz
		Signal-to Noise Ratio	60 dB (Mono)
	[MW]	Tuning Range	522 - 1,611 kHz
		Intermediate Frequency	450 kHz
[Amplifier]	Stereo mode	50W + 50W (8 Ω at 1 kHz, THD 10 %)	
	Surround mode (* Depending on the sound mode settings and the source, there may be no sound output.)	Front: 50W + 50W Centre*: 50W Surround*: 50W + 50W (8 Ω at 1 kHz, THD 10 %) Subwoofer*: 80W (4 Ω at 50 Hz, THD 10 %)	
	Outputs	PHONES: (32 Ω , 25mW)	
[Speakers]		Satellite Speaker (SSX-VX33S)	Passive Subwoofer (SSX-VX33W)
	Type	1 Way 1 Speaker	1 Way 1 Speaker
	Impedance	8 Ω	4 Ω
	Frequency Response	180 - 20,000 Hz	45 - 180 Hz
	Rated Input Power	50W	80W
	Max. Input Power	100W	160W
	Net Dimensions (W x H x D)	97 x 100 x 118 mm	222 x 325 x 273 mm
Net Weight	0.6 kg	4.8 kg	
[Supplied Accessories]	<ul style="list-style-type: none"> • Speakers5 • Subwoofer1 • Remote Commander (remote) RM-Z20012 .1 • Operating Instructions1 • Speakers - Connection and Installation (card)1 • Video cable1 • Speaker cables6 • Size AAA (R03) batteries2 • AM loop antenna1 • FM antenna1 • Ferrite core1 • Foot pads20 		

* Designs and specifications are subject to change without notice.

