

HSIM-G01/G09 User's Guide

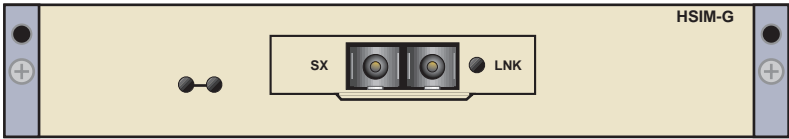



Only qualified personnel should perform installation procedures.

NOTICE

Cabletron Systems reserves the right to make changes in specifications and other information contained in this document without prior notice. The reader should in all cases consult Cabletron Systems to determine whether any such changes have been made.

The hardware, firmware, or software described in this manual is subject to change without notice.

IN NO EVENT SHALL CABLETRON SYSTEMS BE LIABLE FOR ANY INCIDENTAL, INDIRECT, SPECIAL, OR CONSEQUENTIAL DAMAGES WHATSOEVER (INCLUDING BUT NOT LIMITED TO LOST PROFITS) ARISING OUT OF OR RELATED TO THIS MANUAL OR THE INFORMATION CONTAINED IN IT, EVEN IF CABLETRON SYSTEMS HAS BEEN ADVISED OF, KNOWN, OR SHOULD HAVE KNOWN, THE POSSIBILITY OF SUCH DAMAGES.

© 1998 by Cabletron Systems, Inc., P.O. Box 5005, Rochester, NH 03866-5005
All Rights Reserved
Printed in the United States of America

Order Number: 9032398-04 November 1998

Cabletron Systems and **LANVIEW** are registered trademarks of Cabletron Systems, Inc.

All other product names mentioned in this manual may be trademarks or registered trademarks of their respective companies.

FCC NOTICE

This device complies with Part 15 of the FCC rules. Operation is subject to the following two conditions: (1) this device may not cause harmful interference, and (2) this device must accept any interference received, including interference that may cause undesired operation.

NOTE: This equipment has been tested and found to comply with the limits for a Class A digital device, pursuant to Part 15 of the FCC rules. These limits are designed to provide reasonable protection against harmful interference when the equipment is operated in a commercial environment. This equipment uses, generates, and can radiate radio frequency energy and if not installed in accordance with the operator's manual, may cause harmful interference to radio communications. Operation of this equipment in a residential area is likely to cause interference in which case the user will be required to correct the interference at his own expense.

WARNING: Changes or modifications made to this device which are not expressly approved by the party responsible for compliance could void the user's authority to operate the equipment.

INDUSTRY CANADA NOTICE

This digital apparatus does not exceed the Class A limits for radio noise emissions from digital apparatus set out in the Radio Interference Regulations of the Canadian Department of Communications.

Le présent appareil numérique n'émet pas de bruits radioélectriques dépassant les limites applicables aux appareils numériques de la class A prescrites dans le Règlement sur le brouillage radioélectrique édicté par le ministère des Communications du Canada.

VCCI NOTICE

This is a Class A product based on the standard of the Voluntary Control Council for Interference by Information Technology Equipment (VCCI). If this equipment is used in a domestic environment, radio disturbance may arise. When such trouble occurs, the user may be required to take corrective actions.

この装置は、情報処理装置等電波障害自主規制協議会（VCCI）の基準に基づくクラスA情報技術装置です。この装置を家庭環境で使用すると電波妨害を引き起こすことがあります。この場合には使用者が適切な対策を講ずるよう要求されることがあります。

CABLETRON SYSTEMS, INC. PROGRAM LICENSE AGREEMENT

IMPORTANT: Before utilizing this product, carefully read this License Agreement.

This document is an agreement between you, the end user, and Cabletron Systems, Inc. ("Cabletron") that sets forth your rights and obligations with respect to the Cabletron software program (the "Program") contained in this package. The Program may be contained in firmware, chips or other media. BY UTILIZING THE ENCLOSED PRODUCT, YOU ARE AGREEING TO BECOME BOUND BY THE TERMS OF THIS AGREEMENT, WHICH INCLUDES THE LICENSE AND THE LIMITATION OF WARRANTY AND DISCLAIMER OF LIABILITY. IF YOU DO NOT AGREE TO THE TERMS OF THIS AGREEMENT, PROMPTLY RETURN THE UNUSED PRODUCT TO THE PLACE OF PURCHASE FOR A FULL REFUND.

CABLETRON SOFTWARE PROGRAM LICENSE

1. **LICENSE.** You have the right to use only the one (1) copy of the Program provided in this package subject to the terms and conditions of this License Agreement.

You may not copy, reproduce or transmit any part of the Program except as permitted by the Copyright Act of the United States or as authorized in writing by Cabletron.
2. **OTHER RESTRICTIONS.** You may not reverse engineer, decompile, or disassemble the Program.
3. **APPLICABLE LAW.** This License Agreement shall be interpreted and governed under the laws and in the state and federal courts of New Hampshire. You accept the personal jurisdiction and venue of the New Hampshire courts.

EXCLUSION OF WARRANTY AND DISCLAIMER OF LIABILITY

1. **EXCLUSION OF WARRANTY.** Except as may be specifically provided by Cabletron in writing, Cabletron makes no warranty, expressed or implied, concerning the Program (including its documentation and media).

CABLETRON DISCLAIMS ALL WARRANTIES, OTHER THAN THOSE SUPPLIED TO YOU BY CABLETRON IN WRITING, EITHER EXPRESSED OR IMPLIED, INCLUDING BUT NOT LIMITED TO IMPLIED WARRANTIES OF MERCHANTABILITY AND FITNESS FOR A PARTICULAR PURPOSE, WITH RESPECT TO THE PROGRAM, THE ACCOMPANYING WRITTEN MATERIALS, AND ANY ACCOMPANYING HARDWARE.

2. **NO LIABILITY FOR CONSEQUENTIAL DAMAGES.** IN NO EVENT SHALL CABLETRON OR ITS SUPPLIERS BE LIABLE FOR ANY DAMAGES WHATSOEVER (INCLUDING, WITHOUT LIMITATION, DAMAGES FOR LOSS OF BUSINESS, PROFITS, BUSINESS INTERRUPTION, LOSS OF BUSINESS INFORMATION, SPECIAL, INCIDENTAL, CONSEQUENTIAL, OR RELIANCE DAMAGES, OR OTHER LOSS) ARISING OUT OF THE USE OR INABILITY TO USE THIS CABLETRON PRODUCT, EVEN IF CABLETRON HAS BEEN ADVISED OF THE POSSIBILITY OF SUCH DAMAGES. BECAUSE SOME STATES DO NOT ALLOW THE EXCLUSION OR LIMITATION OF LIABILITY FOR CONSEQUENTIAL OR INCIDENTAL DAMAGES, OR ON THE DURATION OR LIMITATION OF IMPLIED WARRANTIES, IN SOME INSTANCES THE ABOVE LIMITATIONS AND EXCLUSIONS MAY NOT APPLY TO YOU.

UNITED STATES GOVERNMENT RESTRICTED RIGHTS

The enclosed product (a) was developed solely at private expense; (b) contains “restricted computer software” submitted with restricted rights in accordance with Section 52227-19 (a) through (d) of the Commercial Computer Software - Restricted Rights Clause and its successors, and (c) in all respects is proprietary data belonging to Cabletron and/or its suppliers.

For Department of Defense units, the product is licensed with “Restricted Rights” as defined in the DoD Supplement to the Federal Acquisition Regulations, Section 52.227-7013 (c) (1) (ii) and its successors, and use, duplication, disclosure by the Government is subject to restrictions as set forth in subparagraph (c) (1) (ii) of the Rights in Technical Data and Computer Software clause at 252.227-7013. Cabletron Systems, Inc., 35 Industrial Way, Rochester, New Hampshire 03867-0505.

SAFETY INFORMATION

CLASS 1 LASER TRANSCEIVERS

THE HSIM-G01/G09 GIGABIT ETHERNET MODULES USE CLASS 1 LASER TRANSCEIVERS. READ THE FOLLOWING SAFETY INFORMATION BEFORE INSTALLING OR OPERATING THESE ADAPTERS.

The Class 1 laser transceivers use an optical feedback loop to maintain Class 1 operation limits. This control loop eliminates the need for maintenance checks or adjustments. The output is factory set, and does not allow any user adjustment. Class 1 laser transceivers comply with the following safety standards:

- 21 CFR 1040.10 and 1040.11 U.S. Department of Health and Human Services (FDA).
- IEC Publication 825 (International Electrotechnical Commission).
- CENELEC EN 60825 (European Committee for Electrotechnical Standardization).

When operating within their performance limitations, laser transceiver output meets the Class 1 accessible emission limit of all three standards. Class 1 levels of laser radiation are not considered hazardous.

SAFETY INFORMATION

CLASS 1 LASER TRANSCEIVERS

LASER RADIATION AND CONNECTORS

When the connector is in place, all laser radiation remains within the fiber. The maximum amount of radiant power exiting the fiber (under normal conditions) is -12.6 dBm or 55×10^{-6} watts.

Removing the optical connector from the transceiver allows laser radiation to emit directly from the optical port. The maximum radiance from the optical port (under worst case conditions) is 0.8 W cm^{-2} or $8 \times 10^3 \text{ W m}^{-2} \text{ sr}^{-1}$.

Do not use optical instruments to view the laser output. The use of optical instruments to view laser output increases eye hazard. When viewing the output optical port, power must be removed from the network adapter.

DECLARATION OF CONFORMITY

Application of Council Directive(s): **89/336/EEC
73/23/EEC**

Manufacturer's Name: **Cabletron Systems, Inc.**

Manufacturer's Address: **35 Industrial Way
PO Box 5005
Rochester, NH 03867**

European Representative Name: **Mr. J. Solari**

European Representative Address: **Cabletron Systems Limited
Nexus House, Newbury Business Park
London Road, Newbury
Berkshire RG13 2PZ, England**

Conformance to Directive(s)/Product Standards: **EC Directive 89/336/EEC
EC Directive 73/23/EEC
EN 55022
EN 50082-1
EN 60950**

Equipment Type/Environment: **Networking Equipment, for use in a
Commercial or Light Industrial
Environment.**

We the undersigned, hereby declare, under our sole responsibility, that the equipment packaged with this notice conforms to the above directives.

Manufacturer

Mr. Ronald Fotino

Full Name

Principal Compliance Engineer

Title

Rochester, NH, USA

Location

Legal Representative in Europe

Mr. J. Solari

Full Name

Managing Director - E.M.E.A.

Title

Newbury, Berkshire, England

Location

CONTENTS

CHAPTER 1 INTRODUCTION

1.1	Using This Manual.....	1-2
1.2	Document Conventions	1-2
1.3	Getting Help.....	1-3
1.4	Overview.....	1-4
1.4.1	Connectivity	1-4
1.4.2	LANVIEW Diagnostic LEDs	1-4
1.5	Related Documentation	1-4

CHAPTER 2 INSTALLATION

2.1	Unpacking the HSIM-G.....	2-1
2.2	Installing an HSIM-G	2-2
2.2.1	Installing an HSIM-G in an Interface Module	2-2
2.2.2	Installing an HSIM-G in a Standalone Device.....	2-5
2.3	Connecting to the Network	2-6
2.3.1	HSIM-G Network Connection	2-7
2.3.2	HSIM-G09 Connection Using Multimode Cable	2-9

CHAPTER 3

CHAPTER 4 LOCAL MANAGEMENT

4.1	Navigating Local Management Screens.....	4-1
4.2	Gigabit Ethernet Configuration Screen.....	4-2
4.2.1	Configuring the HSIM-G Port.....	4-4
4.2.1.1	Setting the Operational Mode.....	4-5
4.2.1.2	Setting the Advertised Ability.....	4-5

APPENDIX A SPECIFICATIONS

A.1	Gigabit Ethernet Specifications	A-1
A.1.1	HSIM-G01 Specifications (1000Base-SX)	A-1
A.1.2	HSIM-G09 Specifications (1000Base-LX).....	A-2
A.2	Physical Properties.....	A-3
A.3	Environmental Requirements	A-3
A.4	Regulatory Compliance	A-3

CHAPTER 1

INTRODUCTION

Welcome to the Cabletron Systems **HSIM-G01/G09 User's Guide**. This manual describes the HSIM-G01 and HSIM-G09 and provides information concerning features, installation, troubleshooting, the use of Local Management, and specifications.



The HSIM-G01 and HSIM-G09 function identically with one exception: the HSIM-G01 uses a short wavelength laser device that connects to 50 or 62.5 micron multimode fiber optics, and the HSIM-G09 uses a long wavelength laser device that connects to 50 or 62.5 micron multimode fiber optics, or 10 micron single mode fiber optics. Both devices are referred to as the HSIM-G unless otherwise specified in this guide.

A general working knowledge of Gigabit Ethernet and IEEE 802.3z data communications networks and their physical layer components is helpful when installing this device.

The HSIM-G has one Gigabit Ethernet port to provide a fiber optic connection. [Figure 1-1](#) shows the HSIM-G01.

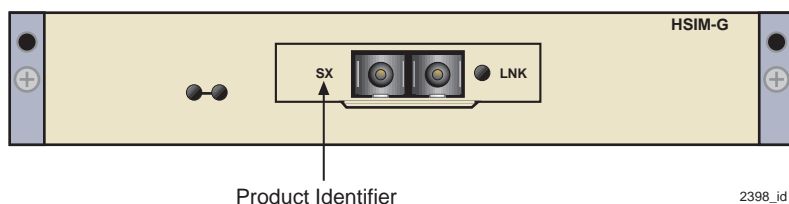

Figure 1-1 HSIM-G01



The HSIM-G01 SC connector is either black or beige, to indicate the short wavelength transceiver, using multimode fiber. The HSIM-G09 SC connector is typically blue, to indicate the long wavelength transceiver. The product identifier is LX for the HSIM-G09.

1.1 USING THIS MANUAL

Read through this manual completely to familiarize yourself with its content and to gain an understanding of the features and capabilities of the HSIM-G. The following list provides an overview of each section of this manual:

Chapter 1, Introduction, outlines the contents of this manual, describes the HSIM-G features and concludes with a list of related manuals.

Chapter 2, Installation, describes how to install an HSIM-G into an interface module or a standalone device (host platform), and how to connect to the network.

Chapter 3, LANVIEW LEDs, describes how to use the HSIM-G LEDs to monitor the HSIM performance and status.

Chapter 4, Local Management, describes the HSIM-G Local Management statistics screens and configuration.

Appendix A, Specifications, lists the operating specifications and regulatory compliance of the HSIM-G.

1.2 DOCUMENT CONVENTIONS

The following conventions are used throughout this document:



Note symbol. Calls the reader's attention to any item of information that may be of special importance.



Caution symbol. Contains information essential to avoid damage to the equipment.



Electrical Hazard Warning symbol. Warns against an action that could result in personal injury or death due to an electrical hazard.

1.3 GETTING HELP

For additional support related to this device or document, contact Cabletron Systems using one of the following methods:

World Wide Web	http://www.cabletron.com/
Phone	(603) 332-9400
Internet mail	support@cabletron.com
FTP	ftp://ftp.cabletron.com/
Login	<i>anonymous</i>
Password	<i>your email address</i>
<p>To send comments or suggestions concerning this document, contact the Cabletron Systems Technical Writing Department via the following email address: TechWriting@cabletron.com <i>Make sure to include the document Part Number in the email message.</i></p>	

Before calling Cabletron Systems, have the following information ready:

- Your Cabletron Systems service contract number
- A description of the failure
- A description of any action(s) already taken to resolve the problem (e.g., changing mode switches, rebooting the unit, etc.)
- The serial and revision numbers of all involved Cabletron Systems products in the network
- A description of your network environment (layout, cable type, etc.)
- Network load and frame size at the time of trouble (if known)
- The device history (i.e., have you returned the device before, is this a recurring problem, etc.)
- Any previous Return Material Authorization (RMA) numbers

1.4 OVERVIEW

The HSIM-G extends the functionality of certain Cabletron Systems interface modules or standalone devices by providing high-speed uplink capability through Gigabit Ethernet technology. [Section 1.4.1](#) and [Section 1.4.2](#) give information on some of the features of the HSIM-G.

1.4.1 Connectivity

The HSIM-G01 module supports 1000Base-SX, providing one SC fiber optic connector for 50 or 62.5 micron multimode fiber optics. The HSIM-G09 module supports 1000Base-LX, offering one SC fiber optic connector for 50 or 62.5 micron multimode fiber optics, or 10 micron single mode fiber optics.

The HSIM-G only operates in full duplex mode.

1.4.2 LANVIEW Diagnostic LEDs

Cabletron Systems provides a visual diagnostic and monitoring system called LANVIEW. The HSIM-G LANVIEW LEDs help you quickly identify transmit and receive status. [Chapter 3](#) provides information on all HSIM-G LEDs.

1.5 RELATED DOCUMENTATION

Any related documentation, such as manuals for a host platform, can be obtained on the World Wide Web in Adobe Acrobat Portable Document Format (PDF) at the following site:

<http://www.cabletron.com/>

CHAPTER 2

INSTALLATION



Only qualified personnel should install or service this unit.

To install the HSIM-G you need the following items:

- Antistatic wrist strap
- Phillips screwdriver



Before attempting to use the HSIM-G you should be familiar with the *IEEE 802.3z* specification. The network installation must meet the guidelines contained in the draft specification to ensure satisfactory performance of the equipment.

2.1 UNPACKING THE HSIM-G



The HSIM-G and the host module or device (host platform) are sensitive to static discharges. Use a grounding strap and observe all static precautions during this procedure. Failure to do so could result in damage to the HSIM-G or host platform.

Unpack the HSIM-G as follows:

1. Remove the shipping box material covering the HSIM-G.
2. Carefully remove the module from the shipping box. Leave the module in its non-conductive bag until you are ready to install it.
3. Attach the antistatic wrist strap. If the HSIM-G is to be installed in a standalone device, refer to the instructions on the antistatic wrist strap package. If the HSIM-G is to be installed in an interface module, refer to the applicable interface module User's Guide.
4. After removing the module from its non-conductive bag, visually inspect the device. If you notice any signs of damage, contact Cabletron Systems immediately. Refer to [Section 1.3](#) for instructions.

2.2 INSTALLING AN HSIM-G

You can install an HSIM-G in any Cabletron Systems device that supports HSIM technology (e.g., 2E42-27, 6E132-25).

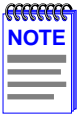

Refer to the release notes for the version of firmware running on the host platform to ensure that the HSIM-G is supported. “Host platform” is used to designate the interface module or standalone device into which the HSIM-G is installed.

The following sections provide instructions for installing an HSIM-G in an interface module or in a standalone device. Refer to your specific interface module or standalone device documentation for exact HSIM slot and connector locations. Refer to [Section 2.2.1](#) to install the HSIM-G in an interface module, and [Section 2.2.2](#) to install the HSIM-G in a standalone device.

2.2.1 Installing an HSIM-G in an Interface Module

To install an HSIM-G in an interface module that supports HSIM technology, perform the following steps.

1. Disconnect any network cables connected to the ports of the interface module.



Note the ports of the interface module that have cables attached to them. Write down the port numbers and label the cables to make it easier to reattach the network properly after the installation.

2. Attach the antistatic wrist strap (refer to the instructions outlined on the interface module User’s Guide).
3. If the module is in a chassis, unlock the top and bottom plastic locking tabs of the module faceplate, and remove the module from the chassis.
4. Lay the module down with the internal components facing up.
5. Refer to [Figure 2-1](#) and remove the two faceplate mounting screws and the HSIM coverplate. Save the screws.
6. Refer to [Figure 2-1](#) and remove the four standoff screws. Save the screws.

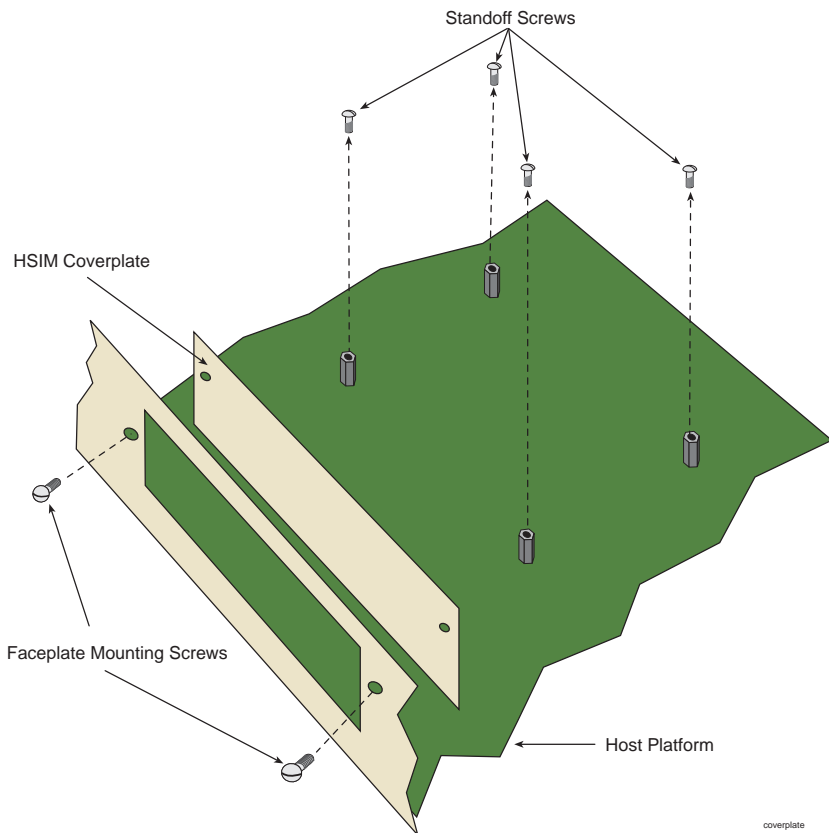

Figure 2-1 Removing the HSIM Coverplate

7. Refer to [Figure 2-2](#) and place the HSIM-G behind the module faceplate.
8. Align the HSIM connector of the HSIM-G with the HSIM pins on the module.



When installing the HSIM-G, ensure that the HSIM pins on the module or device align with the HSIM-G connector to prevent bending the pins. This can damage both the HSIM-G and the module.

9. Press down firmly on the back of the HSIM-G until the connector slides all the way onto the pins.



Ensure that the standoffs on the interface module align with the standoff screw holes on the HSIM-G.

10. Secure the HSIM-G to the module faceplate using the mounting screws saved in step 5.
11. Secure the HSIM-G to the module standoffs using the standoff screws saved in step 6.
12. Reinstall the interface module in the chassis.
13. Reattach the network cabling to the module.

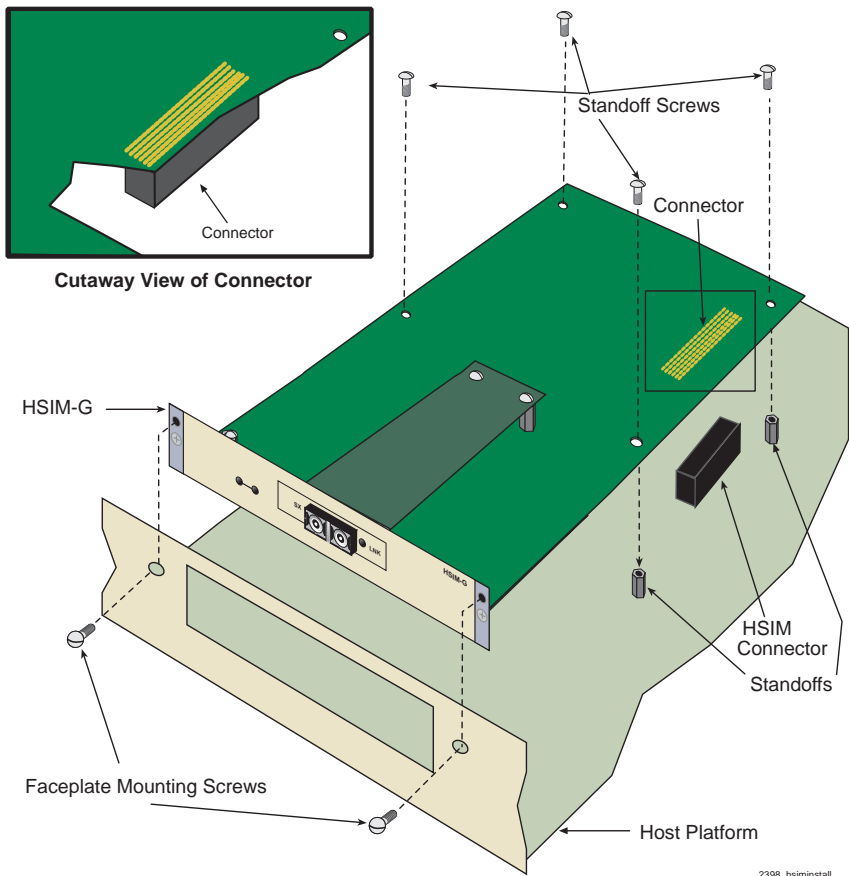

Figure 2-2 Installing the HSIM-G

2.2.2 Installing an HSIM-G in a Standalone Device

To install an HSIM-G into a standalone device (e.g., 2E42-27), perform the following steps:

1. Power down the device and remove the power cord.



To install the HSIM-G in a standalone device, the device must first be powered down. Ensure that you remove the power cord and **ONLY** the screws required to remove the chassis cover.

2. Disconnect any cables connected to the network ports of the device.



Note the ports that have cables attached to them. Write down the port numbers and label the cables to make it easier to reattach the network properly after the installation.

3. Attach the antistatic wrist strap (refer to the instructions outlined on the antistatic wrist strap package).
4. Remove the standalone device chassis cover (refer to your specific standalone device documentation for instructions on removing the chassis cover).
5. Refer back to [Figure 2-1](#) and remove the two faceplate mounting screws and the HSIM coverplate. Save the screws.
6. Remove the four standoff screws. Save the screws.
7. Refer back to [Figure 2-2](#) and place the HSIM-G behind the standalone device faceplate.
8. Align the HSIM connector of the HSIM-G with the pins on the standalone device.
9. Press down firmly on the back of the HSIM-G until the pins slide all the way into the HSIM connector.



Ensure that the standoffs on the standalone device align with the standoff screw holes on the HSIM-G.

10. Secure the HSIM-G to the module faceplate using the mounting screws saved in step 5.

11. Secure the HSIM-G to the module standoffs using the standoff screws saved in step 6.



Ensure that the chassis cover is in place before reconnecting the power cord.

12. Reattach the chassis cover to the standalone device, reconnect the power cord, and reconnect the standalone device to the network.

2.3 CONNECTING TO THE NETWORK

The HSIM-G has an SC style connector for the network port. Cabletron Systems offers fiber optic cables that use SC style connectors which are keyed to ensure proper crossover of the transmit and receive fibers. Check the fiber specifications in [Appendix A](#) for each HSIM-G carefully before connecting an HSIM-G to the network.

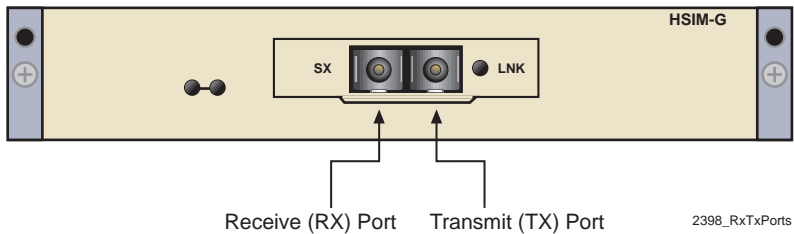

Figure 2-3 HSIM-G Port Designations



An odd number of crossovers (preferably one) must be maintained between like devices so that the transmit port of one device is connected to the receive port of the other device and vice versa.

If the fiber optic cable being used has SC style connectors that do not resemble MIC style connectors, or has SC connectors on one end and a different type on the other, such as ST connectors, ensure that the proper cross over occurs.

2.3.1 HSIM-G Network Connection

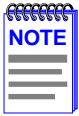

If connecting the HSIM-G09 to the network using multimode fiber cable as the premises cabling, refer to [Section 2.3.2](#) before following this procedure.

To connect the HSIM-G01 using multimode and single mode fiber, and the HSIM-G09 using single mode fiber to the network, perform the following steps:



The HSIM-G uses Class 1 lasers. Do not use optical instruments to view the laser output. The use of optical instruments to view laser output increases eye hazard. When viewing the output optical port, power must be removed from the network adapter.

1. Remove the protective fiber port covers from the fiber optic ports and from the ends of the connectors.

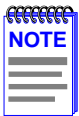

Leave the protective fiber port covers in place when the connectors are not in use to prevent contamination.

Do not touch the ends of the fiber optic strands, and do not let the ends come in contact with dust, dirt, or other contaminants. Contamination of the ends causes problems in data transmissions. If the ends become contaminated, blow the surfaces clean with a canned duster. A fiber port cleaning swab saturated with optical-grade isopropyl alcohol may also be used to clean the ends.

2. Insert one end of the SC connector, key side down, into the HSIM-G. See [Figure 2-4](#). Refer to [Appendix A](#) for the proper fiber cable for the installation.

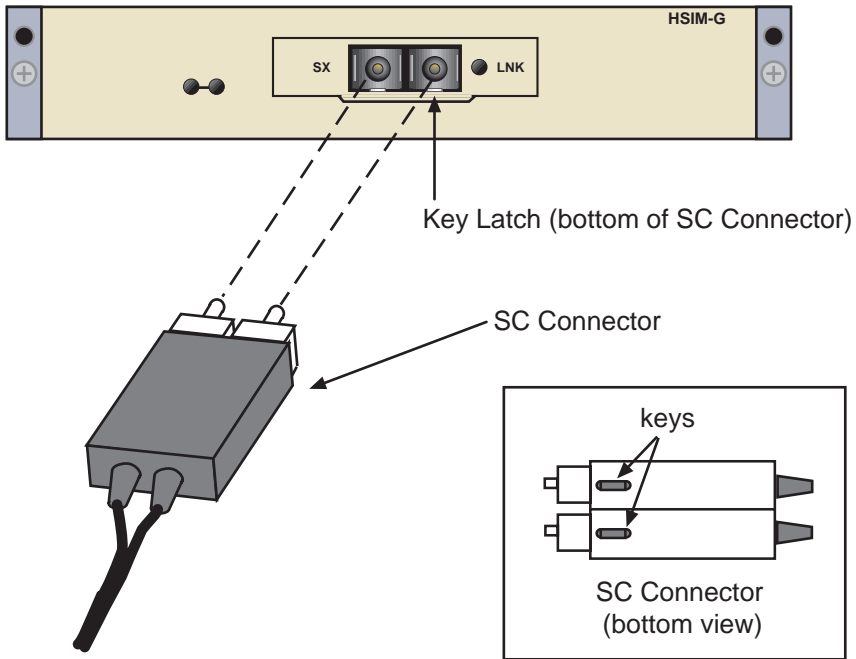

Figure 2-4 Fiber Connections

3. At the other end of the fiber optic cable, attach the SC connector to the other device.
4. Verify that a link exists by checking that the link (**LNK**) LED is ON (solid green), the port receive (**RX**) LED is ON (flashing amber, blinking green, or solid green). Refer to [Chapter 3](#) for the layout of the LEDs. If the **RX** LED is OFF and the transmit (**TX**) LED is not blinking amber, perform the following steps until it is ON:
 - a. Check that the power is turned on for the device at the other end of the link.
 - b. Verify proper crossover of fiber strands between the port on the HSIM-G and the fiber optic device at the other end of the fiber optic link segment.
 - c. Verify that the fiber connection meets the dB loss specifications outlined in [Appendix A](#).

To remove the SC connector, from the HSI-M-G, carefully pull the connector out of the port. It may need to be wiggled gently to release the latching keys.

If a link has not been established, refer to [Chapter 3](#) before contacting Cabletron Systems. Refer to [Section 1.3](#) for details on getting help.

2.3.2 HSI-M-G09 Connection Using Multimode Cable

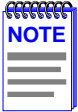

When using premises multimode fiber cable for the HSI-M-G09 (long wave length transceiver), connect Launch Mode Conditioning cable as detailed in the following procedure. This procedure is not needed when connecting single mode fiber cable to the HSI-M-G09. Do not attach Launch Mode Conditioning cable if the installation is not using an HSI-M-G09 with multimode fiber cable.

Launch Mode Conditioning cable is available through Cabletron Systems.

To connect the HSI-M-G09 to the network using multimode fiber, perform the following steps:

1. Connect Launch Mode Conditioning cable to the multimode fiber on both ends of the premises cable before connecting the HSI-M-G09 to the premises cabling. See [Figure 2-5](#).

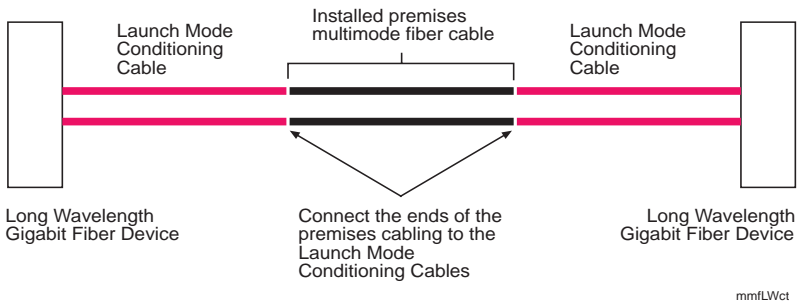

Figure 2-5 Launch Mode Conditioning Cable Connection for the HSI-M-G09

2. Once the Launch Mode Conditioning cable is connected to the ends of the premises multimode fiber cable, return to [Section 2.3.1](#) to complete the installation to the HSI-M-G09 device.

CHAPTER 3

LANVIEW LEDs

This chapter describes how to use the LANVIEW LEDs to monitor the status of the HSIM-G and diagnose problems. [Figure 3-1](#) shows the location of the HSIM-G LEDs.

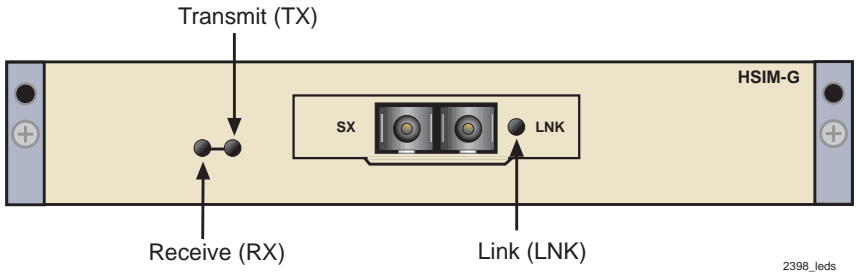
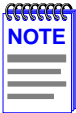

Figure 3-1 HSIM-G LANVIEW LEDs



The terms **flashing**, **blinking**, and **solid** used in Table 3-1 indicate the following:

Flashing indicates an irregular LED pulse.

Blinking indicates a steady LED pulse. (approximately 50% on, 50% off)

Solid indicates a steady LED light. No pulsing.

Table 3-1 HSIM-G LEDs

LED	Color	Definition
Transmit	Green (Flashing)	Activity, port enabled.
	Amber (Blinking)	Port in standby.
	Off	No activity, port enabled.
	Red (Flashing)	Transmit fault.
	Red	Diagnostic failure.
Receive	Green (Solid)	Indicates port has successfully negotiated with link partner. If Auto-Negotiate is disabled, this indicates optical link.
	Green (Blinking)	Link, port disabled.
	Amber (Flashing)	Link, activity. Port enabled.
	Off	No link, no activity. Port enabled or disabled.
	Red	Diagnostic failure.
LNK	Green	Indicates optical link.
	Off	No link.

CHAPTER 4

LOCAL MANAGEMENT

This chapter provides information on the HSI-M-G screens accessible via the Local Management of the host platform. One Local Management screen is specific to the HSI-M-G, which is detailed in this chapter. All other screens are detailed in the Local Management manual for the host platform, and are not covered in this manual. Refer to the host platform's manual for detailed information on the other screens.



Refer to the host platform user's guide to establish a Local Management connection. Refer to [Section 1.5](#) for details on accessing host platform manuals.

Make sure that the following requirements have been met before accessing the HSI-M-G through Local Management:

- The HSI-M-G is installed in the host platform.
- The host platform is powered up and operational.
- A Local Management terminal is properly configured and connected to the host interface module or standalone device in which the HSI-M-G resides.

4.1 NAVIGATING LOCAL MANAGEMENT SCREENS

In order to view the specific Local Management screen for the HSI-M-G, you must navigate through a series of Local Management screens via the host platform. [Figure 4-1](#) shows a typical hierarchy of screens that you may have to navigate through in order to reach the HSI-M-G screens. The screen names shown in **boldface** indicate a typical path you would take.



[Figure 4-1](#) is only an example of how the HSI-M-G screen may be accessed. Refer to the host platform documentation for a detailed definition of the other screens.

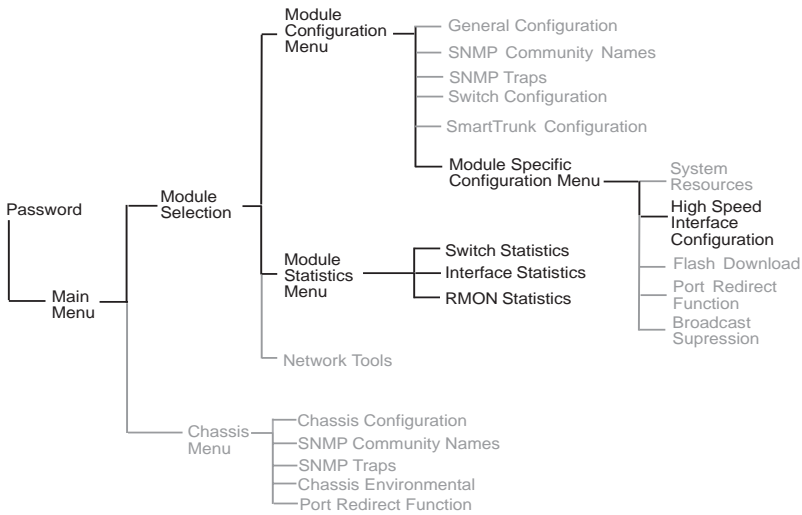

2398-hierarch

Figure 4-1 Typical Hierarchy of Local Management Screens

4.2 GIGABIT ETHERNET CONFIGURATION SCREEN

The Gigabit Ethernet Configuration screen allows the user to support the HSIM-G01 and the HSIM-G09.

The screen (see [Figure 4-2](#)) displays the type of interface used (HSIM-G01 or HSIM-G09), the device or module in which the HSIM-G is installed, and the port number of the module in which it is installed. The link status, current operating mode, and advertised ability are also displayed. The screen allows the user to enable or disable Auto-Negotiation and Advertised Ability.

To access the Gigabit Ethernet Configuration screen, navigate through the Local Management screens until the **Module** or **Device Specific Configuration Menu** screen displays. Use the arrow keys to highlight the **High Speed Interface Configuration** menu item and press ENTER. The Gigabit Ethernet Configuration screen, [Figure 4-2](#), displays.

```
Event Message Line
                                6E133-25 LOCAL MANAGEMENT
                                Gigabit Ethernet HSIM 1 Configuration
Module Type: 6E133-25           Firmware Revision: XX.XX.XX
Slot Number: X                 BOOTPROM Revision: XX.XX.XX

                                Port X

Port Type                       HSIM-G01
Link Status                     Link
Current Oper. Mode              1000Base-XFD
Desired Oper. Mode              [Auto-Negotiation]
Advertised Ability              [1000Base-XFD]      [Enabled]

[SAVE]                           EXIT                           RETURN
```

2398_GigaConfig

Figure 4-2 Gigabit Ethernet Configuration Screen

The following defines each field of the Gigabit Ethernet Configuration screen.

Port X (Read-Only)

The port or interface number on the host platform in which the HSIM-G is installed.

Port Type (Read-Only)

Displays the type of interface (HSIM-G01 or HSIM-G09) installed in the HSIM-G. [Figure 4-2](#) shows an HSIM-G01 installed.

Link Status (Read-Only)

Indicates whether or not there is a physical connection from this port to another gigabit Ethernet port. One of the following values displays:

- **Link** - There is a link signal present and a valid physical connection to another device.
- **No Link** - There is no link signal present and no valid physical connection to another device.
- **NA** - The port has not completed its auto-negotiation.

Current Oper. Mode (Read-Only)

Displays the current operating mode of the port. Regardless of whether an HSIM-G01 or HSIM-G09 is installed, this field displays 1000Base-XFD.

Desired Oper. Mode (Toggle)

Allows the user to select the desired operational mode for an HSIM-G interface. The field toggles between Auto-Negotiation and 1000Base-XFD. [Section 4.2.1](#) describes how to configure a port with an HSIM-G01 or HSIM-G09 interface.

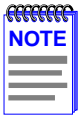

In normal operation, the installed port automatically establishes a link with the device at the other end of the segment without requiring user setup. However, Local Management provides the user with the option of manually configuring the port.

With either the HSIM-G01 or the HSIM-G09 installed, the field toggles between Auto-Negotiation and 1000Base-XFD. In normal operation with an 802.3z compliant device at the other end of the link, the port installed is capable of auto-negotiating the operational mode and no further user setup is required. For devices that do not support Auto-Negotiation, 1000Base-XFD should be selected. The link partners must match on both sides of the link. [Section 4.2.1](#) describes how to manually configure the HSIM-G.

Advertised Ability (Read-Only)

Displays the current advertised ability, which is 1000Base-XFD.

4.2.1 Configuring the HSIM-G Port

In normal operation, an HSIM-G port automatically establishes a link when set to Auto-Negotiation (with an 802.3z compliant device at the other end of the segment) and no further user setup is required. To set the operation of the HSIM-G to auto-negotiate, refer to [Section 4.2.1.1](#).

[Section 4.2.1.1](#) and [Section 4.2.1.2](#) provide instructions for manually configuring the port, normally done when there is a non-compliant device at the other end of the segment.

4.2.1.1 Setting the Operational Mode

Use the Desired Oper. Mode field to set the active technology. This field steps between **Auto-Negotiation** and **1000Base-XFD**. If

Auto-Negotiation is selected, the HSI-M-G automatically sets the active technology to auto-negotiate with another 802.3z compliant device.

1000Base-XFD must be chosen if the device on the other side of the link does not support Auto-Negotiation.

To manually set the active technology through Local Management, proceed as follows:

1. Use the arrow keys to highlight the **Desired Oper. Mode** field.
2. Use the SPACE bar to select the desired mode. Press ENTER. You may select **Auto-Negotiation** or **1000Base-XFD**. If 1000Base-XFD is selected, the port only operates in 1000Base-XFD and Auto-Negotiation is disabled.
3. Use the arrow keys to highlight the **SAVE** command. Press ENTER. The message "SAVED OK" displays and Local Management saves the changes to memory. The selected mode is displayed in both the Desired Operational Mode field and the Current Operational Mode field.

4.2.1.2 Setting the Advertised Ability

The HSI-M-G auto-negotiates using 1000BaseXFD with an 802.3z compliant device on the other end of the link. Under certain circumstances (refer to **Desired Oper. Mode (Toggle)**), the Network Administrator may not want the port to advertise the available mode. To set the advertised ability, proceed as follows:

1. Use the arrow keys to highlight the **Enabled/Disabled** field to the right of the selection.
2. Use the SPACE bar to select **Enabled** or **Disabled**. Press ENTER.
3. Use the arrow keys to highlight the **SAVE** command. Press ENTER. The message "SAVED OK" displays and Local Management saves the changes to memory.

APPENDIX A

SPECIFICATIONS

This appendix lists the specifications and regulatory requirements for the HSIM-G01 and HSIM-G09. Cabletron Systems reserves the right to change these specifications at any time without notice.

The HSIM-G01 and HSIM-G09 are both fiber optic devices with an SC connector. The HSIM-G01 supports multimode (MMF) fiber cable, and the HSIM-G09 supports both multimode and single mode (SMF) fiber cable, as indicated in [Table A-1](#) below. To use multimode fiber with the HSIM-G09, Launch Mode Conditioning cable must be used. Refer to [Section 2.3.2](#) for details.

A.1 GIGABIT ETHERNET SPECIFICATIONS

The following specifications for the HSIM-G meet the IEEE 802.3z specifications.

A.1.1 HSIM-G01 Specifications (1000Base-SX)

Table A-1 HSIM-G01 Optical Specifications

	62.5 μm MMF	50 μm MMF
Transmit Power (minimum)	-9.5 dBm	-9.5 dBm
Receive Sensitivity	-17 dBm	-17 dBm
Link Power Budget	7.5 dBm	7.5 dBm

Table A-2 HSIM-G01 Operating Range

	Modal Bandwidth @ 850 nm	Range
62.5 μm MMF	160 MHz/km	2-220 Meters
62.5 μm MMF	200 MHz/km	2-275 Meters
50 μm MMF	400 MHz/km	2-500 Meters
50 μm MMF	500 MHz/km	2-550 Meters

A.1.2 HSIM-G09 Specifications (1000Base-LX)

Table A-3 HSIM-G09 Optical Specifications

	62.5 μm MMF	50 μm MMF	10 μm MMF
Transmit Power (minimum)	-11.5 dBm	-11.5 dBm	-11 dBm
Receive Sensitivity	-19 dBm	-19 dBm	-19 dBm
Link Power Budget	7.5 dBm	7.5 dBm	8 dBm

Table A-4 GPIM-09 Operating Range

	Modal Bandwidth @ 1300 nm	Range
62.5 μm MMF	500 MHz/km	2-550 ^A Meters
50 μm MMF	400 MHz/km	2-550 ^A Meters
50 μm MMF	500 MHz/km	2-550 ^A Meters
10 μm SMF	N/A	2-5000 Meters

A. In order to obtain the distance of 550 m for the GPIM-09 using multimode fiber, Launch Mode Conditioning cable must be used. Refer to [Section 2.3.2](#) for details.

A.2 PHYSICAL PROPERTIES

Dimensions	3.18H x 16.51W x 29.21D (cm) 1.25H x 6.5W x 11.5D (in)
Weight	2.27 kg (5 lb)
MTBF (Predicted)	200,000 hours

A.3 ENVIRONMENTAL REQUIREMENTS

Operating Temperature	5°C to 40°C (41°F to 104°F)
Storage Temperature	-30°C to 73°C (-22°F to 164°F)
Operating Relative Humidity	5% to 90% (non-condensing)

A.4 REGULATORY COMPLIANCE

This equipment meets the following safety and electromagnetic compatibility (EMC) requirements:

Safety	UL 1950, CSA C22.2 No. 950, EN60950, IEC 950, and 73/23/EEC
Electromagnetic Compatibility (EMC)	FCC Part 15, EN 55022, CSA C108.8, EN 50082-1, VCCI V-3, 89/336/EEC, and AS/NZS 3548

