

MK₅TM NXTM Electronics

NX

NX-B

NX-LP

NX-50

NX-75

NX w/ACC

DEALER: Keep this manual. The procedures in this manual **MUST** be performed by a qualified technician.

For more information regarding
Invacare products, parts, and services,
please visit www.invacare.com



Yes, you can.

⚠ WARNING

A QUALIFIED TECHNICIAN MUST PERFORM THE INITIAL SET UP OF THIS WHEELCHAIR. ALSO, A QUALIFIED TECHNICIAN MUST PERFORM ALL PROCEDURES IN THE SERVICE MANUAL.

WHEELCHAIR USERS: DO NOT SERVICE OR OPERATE THIS EQUIPMENT WITHOUT FIRST READING AND UNDERSTANDING (1) THE OWNER'S OPERATOR AND MAINTENANCE MANUAL AND (2) THE SEATING SYSTEM MANUAL (IF APPLICABLE). IF YOU ARE UNABLE TO UNDERSTAND THE WARNINGS, CAUTIONS, AND INSTRUCTIONS, CONTACT INVACARE TECHNICAL SUPPORT BEFORE ATTEMPTING TO SERVICE OR OPERATE THIS EQUIPMENT - OTHERWISE INJURY OR DAMAGE MAY RESULT.

DEALERS AND QUALIFIED TECHNICIANS: DO NOT SERVICE OR OPERATE THIS EQUIPMENT WITHOUT FIRST READING AND UNDERSTANDING (1) THE OWNER'S OPERATOR AND MAINTENANCE MANUAL, (2) THE SERVICE MANUAL (IF APPLICABLE) AND (3) THE SEATING SYSTEM MANUAL (IF APPLICABLE). IF YOU ARE UNABLE TO UNDERSTAND THE WARNINGS, CAUTIONS AND INSTRUCTIONS, CONTACT INVACARE TECHNICAL SUPPORT BEFORE ATTEMPTING TO SERVICE OR OPERATE THIS EQUIPMENT - OTHERWISE, INJURY OR DAMAGE MAY RESULT.

USEFUL TERMS

The following acronyms are used throughout this manual:

ACRONYM	DEFINITION
SPJ	Single Purpose Joystick
CSPJ	Composite Single Purpose Joystick
ACC	Accessory
NX AND NX-50	Non-Expandable
NX-LP	Non-Expandable Limited Programming
NX-B	Non-Expandable with Alternate Standard Program
NX-75	Non-Expandable with 75 Amps
RWD	Rear Wheel Drive
CWD	Center Wheel Drive
DCI	Drive Control Input

NOTE: Updated versions of this manual are available on www.invacare.com.

TABLE OF CONTENTS

USEFUL TERMS	2
SPECIAL NOTES	5
SECTION 1—GENERAL GUIDELINES	6
Controller Settings/Repair or Service	6
Operation Information	6
SECTION 2—EMI INFORMATION	7
SECTION 3—TROUBLESHOOTING	9
All Power Wheelchairs	9
Wheelchairs With Elevate Systems.....	10
SECTION 4—JOYSTICK DESCRIPTIONS	11
SPJ™ and CSPJ™ Joystick Switches and Indicators	11
On/Off Switch.....	11
SPJ Joysticks	11
CSPJ Joysticks	11
Speed Control Knob.....	12
Joystick.....	12
Charger/Programming Input.....	12
Information Gauge Display	12
SPJ+ and SPJ+ w/ACC Joystick Switches and Indicators	15
On/Off Button	16
Speedometer	16
Speed Control Buttons.....	16
Mode Button.....	16
Joystick.....	17
Charger/Programming Input.....	17
Service Indicator.....	17
Information Gauge Display	17
SECTION 5—PERFORMANCE ADJUSTMENTS	19
Main Menu.....	19
Performance Adjust Menu.....	19
NX, NX-50, NX-75, NX w/ACC, and NX-B	19
NX-LP.....	20
Making Performance Adjustments.....	20
NX, NX-50, NX-75, NX w/ACC, and NX-B Controller	22
Flowchart	22
Performance Menu Description	23
NX-LP Controller.....	24
Flowchart	24
Performance Menu Description	25

TABLE OF CONTENTS

SECTION 6—REMOTE PROGRAMMER	26
Overview	26
Remote Programmer Terminology	27
Function.....	27
Value	27
Program (Preset Programs with Standard Value Settings).....	27
Temporary Memory.....	27
User Memory Values.....	27
Description Of Remote Programmer Keys	28
SECTION 7—PROGRAMS	29
Program Settings.....	29
SECTION 8—OTHER FUNCTIONS	33
Description of Other Functions.....	33
SECTION 9—DIAGNOSTIC CODES	34
What Are Diagnostics Codes?	34
SECTION 10—CONNECTOR DESCRIPTIONS	37
Controller Connector Descriptions.....	37
NX, NX-50, NX-75, NX-B and NX-LP.....	37
NX w/ACC.....	37
Battery Connector Pinout	38
Motor Connector Pinout.....	38
Joystick Connector Pinout.....	38
Drive Control Input (DCI)	38
NX, NX-50, NX-75, NX-B, and NX-LP	39
NX w/ACC	39
Battery Charger Port	39
LIMITED WARRANTY	40

SPECIAL NOTES

Signal words are used in this manual and apply to hazards or unsafe practices which could result in personal injury or property damage. Refer to the table below for definitions of the signal words.

SIGNAL WORD	MEANING
DANGER	Danger indicates an imminently hazardous situation which, if not avoided will result in death or serious injury.
WARNING	Warning indicates a potentially hazardous situation which, if not avoided, could result in death or serious injury.
CAUTION	Caution indicates a potentially hazardous situation which, if not avoided, may result in property damage.

NOTICE

THE INFORMATION CONTAINED IN THIS DOCUMENT IS SUBJECT TO CHANGE WITHOUT NOTICE.

THIS MANUAL PERTAINS TO ONLY MK₅ ELECTRONICS.

⚠ REPAIR OR SERVICE WARNING

Setup of the Electronics Control Unit is to be performed only by a qualified technician. The adjustments of the controller may affect other activities of the wheelchair. Damage to the equipment could occur if improperly set-up or adjusted.

⚠ OPERATION WARNING

Performance adjustments should only be made by professionals of the health care field or persons fully conversant with this process and the driver's capabilities. Incorrect settings could cause injury to the driver, bystanders, damage to the wheelchair and surrounding property. After the wheelchair has been setup, check to make sure that the wheelchair performs to the specifications entered in the setup procedure. If the wheelchair does not perform to specifications, turn the wheelchair off immediately and re-enter setup specifications. Repeat this procedure until the wheelchair performs to specifications.

⚠ WARNING

Invacare products are specifically designed and manufactured for use in conjunction with Invacare accessories. Accessories designed by other manufacturers have not been tested by Invacare and are not recommended for use with Invacare products.

Wheelchairs should be examined during maintenance for signs of corrosion (water exposure, incontinence, etc.). Electrical components damaged by corrosion should be replaced **IMMEDIATELY**.

Wheelchairs that are used by incontinent users and/or are frequently exposed to water may require replacement of electrical components more frequently.

SECTION I—GENERAL GUIDELINES

⚠ WARNING

SECTION I - GENERAL GUIDELINES contains important information for the safe operation and use of this product. **DO NOT** use this product or any available optional equipment without first completely reading and understanding these instructions and any additional instructional material such as **Owner's Manuals, Service Manuals or Instruction Sheets** supplied with this product or optional equipment. If you are unable to understand the **Warnings, Cautions or Instructions**, contact a healthcare professional, dealer or technical personnel before attempting to use this equipment - otherwise, injury or damage may occur.

Controller Settings/Repair or Service

Set-up of the Electronics Control Unit is to be performed only by a qualified technician. The final adjustments of the controller may affect other activities of the wheelchair. Damage to the equipment could occur if improperly set-up or adjusted.

Operation Information

After the wheelchair has been set-up, check to make sure that the wheelchair performs to the specifications entered during the set-up procedure. If the wheelchair does not perform to specifications, turn the wheelchair off immediately and reenter set-up specifications. Repeat this procedure until the wheelchair performs to specifications.

Invacare products are specifically designed and manufactured for use in conjunction with Invacare accessories. Accessories designed by other manufacturers have not been tested by Invacare and are not recommended for use with Invacare products.

DO NOT use the wheelchair if the joystick boot is torn or cracked. If the joystick boot becomes torn or cracked, replace **IMMEDIATELY**.

If the joystick knob is missing, **DO NOT** use the wheelchair. In case of a fall, the exposed stem could cause serious personal injury.

Periodically inspect the joystick and joystick cable for damage. Joystick cable **MUST** be routed and secured properly to ensure that cable does not become entangled and damaged/pinched during normal operation of wheelchair. If the joystick and/or cable is damaged, **DO NOT** use the wheelchair.

If the joystick knob does not return back to the neutral position, **DO NOT** use the wheelchair.

SECTION 2—EMI INFORMATION

⚠ WARNING

CAUTION: IT IS VERY IMPORTANT THAT YOU READ THIS INFORMATION REGARDING THE POSSIBLE EFFECTS OF ELECTROMAGNETIC INTERFERENCE ON YOUR POWERED WHEELCHAIR.

Electromagnetic Interference (EMI) From Radio Wave Sources

Powered wheelchairs and motorized scooters (in this text, both will be referred to as powered wheelchairs) may be susceptible to electromagnetic interference (EMI), which is interfering electromagnetic energy (EM) emitted from sources such as radio stations, TV stations, amateur radio (HAM) transmitters, two way radios, and cellular phones. The interference (from radio wave sources) can cause the powered wheelchair to release its brakes, move by itself, or move in unintended directions. It can also permanently damage the powered wheelchair's control system. The intensity of the interfering EM energy can be measured in volts per meter (V/m). Each powered wheelchair can resist EMI up to a certain intensity. This is called its "immunity level." The higher the immunity level, the greater the protection. At this time, current technology is capable of achieving at least a 20 V/m immunity level, which would provide useful protection from the more common sources of radiated EMI.

There are a number of sources of relatively intense electromagnetic fields in the everyday environment. Some of these sources are obvious and easy to avoid. Others are not apparent and exposure is unavoidable. However, we believe that by following the warnings listed below, your risk to EMI will be minimized.

The sources of radiated EMI can be broadly classified into three types:

- 1) Hand-held Portable transceivers (transmitters-receivers with the antenna mounted directly on the transmitting unit. Examples include: citizens band (CB) radios, "walkie talkie", security, fire and police transceivers, cellular telephones, and other personal communication devices).

NOTE: Some cellular telephones and similar devices transmit signals while they are ON, even when not being used.

- 2) Medium-range mobile transceivers, such as those used in police cars, fire trucks, ambulances and taxis. These usually have the antenna mounted on the outside of the vehicle; and
- 3) Long-range transmitters and transceivers, such as commercial broadcast transmitters (radio and TV broadcast antenna towers) and amateur (HAM) radios.

NOTE: Other types of hand-held devices, such as cordless phones, laptop computers, AM/FM radios, TV sets, CD players, cassette players, and small appliances, such as electric shavers and hair dryers, so far as we know, are not likely to cause EMI problems to your powered wheelchair.

⚠ WARNING

Powered Wheelchair Electromagnetic Interference (EMI)

Because EM energy rapidly becomes more intense as one moves closer to the transmitting antenna (source), the EM fields from hand-held radio wave sources (transceivers) are of special concern. It is possible to unintentionally bring high levels of EM energy very close to the powered wheelchair's control system while using these devices. This can affect powered wheelchair movement and braking. Therefore, the warnings listed below are recommended to prevent possible interference with the control system of the powered wheelchair.

Electromagnetic interference (EMI) from sources such as radio and TV stations, amateur radio (HAM) transmitters, two-way radios, and cellular phones can affect powered wheelchairs and motorized scooters.

FOLLOWING THE WARNINGS LISTED BELOW SHOULD REDUCE THE CHANCE OF UNINTENDED BRAKE RELEASE OR POWERED WHEELCHAIR MOVEMENT WHICH COULD RESULT IN SERIOUS INJURY.

- 1) Do not operate hand-held transceivers (transmitters receivers), such as citizens band (CB) radios, or turn ON personal communication devices, such as cellular phones, while the powered wheelchair is turned ON;
- 2) Be aware of nearby transmitters, such as radio or TV stations, and try to avoid coming close to them;
- 3) If unintended movement or brake release occurs, turn the powered wheelchair OFF as soon as it is safe;
- 4) Be aware that adding accessories or components, or modifying the powered wheelchair, may make it more susceptible to EMI (NOTE: There is no easy way to evaluate their effect on the overall immunity of the powered wheelchair); and
- 5) Report all incidents of unintended movement or brake release to the powered wheelchair manufacturer, and note whether there is a source of EMI nearby.

Important Information

- 1) 20 volts per meter (V/m) is a generally achievable and useful immunity level against EMI (as of May 1994) (the higher the level, the greater the protection).
- 2) This device has been tested to a radiated immunity level of 20 volts per meter.
- 3) The immunity level of the product is unknown.

Modification of any kind to the electronics of this wheelchair as manufactured by Invacare may adversely affect the EMI immunity levels.

SECTION 3—TROUBLESHOOTING

All Power Wheelchairs

SYMPTOM	PROBABLE CAUSE	SOLUTIONS
Error Code E03 or E04, 3 or 4 flashes of joystick LEDs.	Motor lock levers disengaged.	Engage motor lock levers. Refer to the wheelchair Owner's Manual for more information.
	Bad motor connection.	Check all motor connections.
		Ohm out motors. Check brushes and replace if necessary. Replace motors if high reading is present. Normal reading is 0.2-5 Ohms (4 Pole motors) or 0.5-5 Ohms (2 Pole motors). Refer to wheelchair Service Manual.
Bad brake coil	Ohm out brake connection. Normal reading is 40-80 Ohms.	
Error Code E02, 2 flashes of joystick LEDs.	Batteries need to be charged.	Charge batteries. Refer to the wheelchair Owner's Manual for charging instructions.
Joystick erratic or does not respond as desired.	Damaged motor coupling.	Contact Dealer/Invacare for Service.
	Electrical malfunction.	Contact Dealer/Invacare for Service.
	Controller programmed improperly.	Contact Dealer/Invacare to have controller reprogrammed.
Wheelchair veers to the left or right when driving on level surface.	Joystick needs to be calibrated.	Calibrate joystick with programmer. If this does not work, replace joystick. Refer to <u>Joystick Throw</u> on page 33 for calibration information.
No LED's on joystick.	Joystick connection to controller unplugged or damaged.	Check all joystick connections. Refer to wheelchair Owner's Manual. If damage is found, replace joystick.
Corroded wiring or connections.	Possible water, salt, or urine damage.	Replace wiring harness. Refer to wheelchair Owner's Manual.
Wheelchair does not respond to commands.	Poor battery terminal connection.	Have clean terminals. Refer to wheelchair Owner's Manual.
	Bad joystick connection.	Check all joystick connections. Refer to wheelchair Owner's Manual.
	Bad wiring harness connection or blown fuse.	Replace wiring harness. Refer to wheelchair Owner's Manual.
	Battery charger connected to joystick.	Unplug battery charger.
Power indicator off - even after recharging.	Electrical malfunction.	Contact Invacare.

Wheelchairs With Elevate Systems

SYMPTOM	PROBABLE CAUSE	SOLUTIONS
Seating system not functioning or working intermittently.	Low batteries.	Charge batteries. Refer to the seating system Owner's Manual.
	Faulty electrical connection.	Check all connections.
	Blown fuse.	Replace wiring harness. Refer to the seating system Owner's Manual.
	Seat has been driven under a heavy load for an extended period of time.	Allow time for the electronics to cool down (Light Duty Use). Leave power on, and do not activate powered seating functions for at least 3 minutes.
	Open Motor connection/ Motor locks disengaged.	Check all motor connectors.
Make sure motor locks are engaged.		
Wheelchair slows while driving.	Elevating seat is elevated. The elevating seat is equipped with a speed reduction safety mechanism. While the seat is in an elevated position, the safety feature slows the speed of the wheelchair by 80%.	Return the seat to its lowest position. Refer to the seating system Owner's Manual.
Wheelchair drives at full speed when seat is elevated.	Faulty electrical connection.	Check all connectors.
	Malfunctioning seating system controller.	Check for error codes. Refer to Performance Adjustments on page 19 for the correct performance adjustment menu descriptions. Replace seating system controller, if necessary. Contact Invacare.

SECTION 4—JOYSTICK DESCRIPTIONS

SPJ™ and CSPJ™ Joystick Switches and Indicators

NOTE: For the following information, refer to FIGURE 4.1.

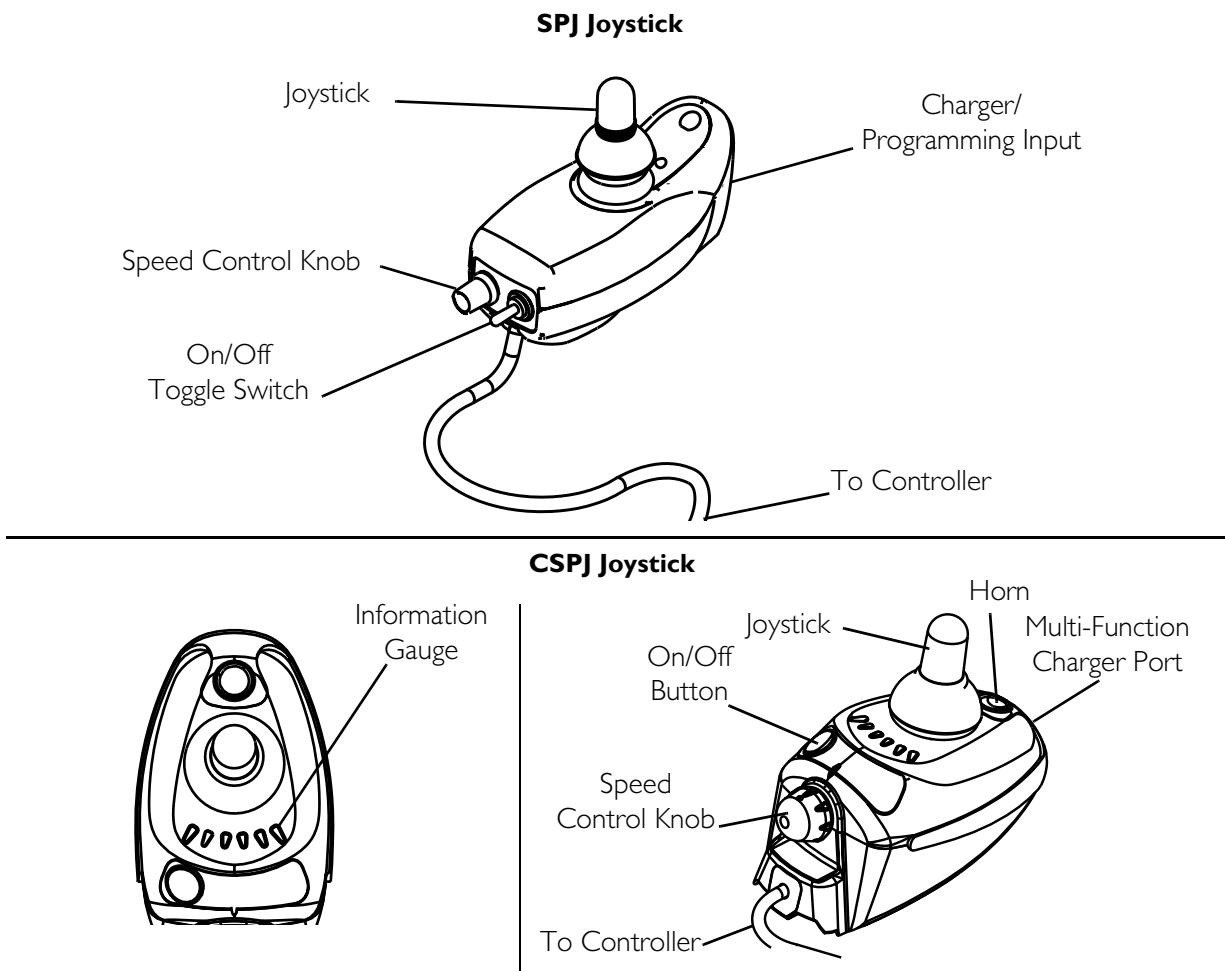

FIGURE 4.1 SPJ™ and CSPJ™ Joystick Switches and Indicators

On/Off Switch

SPJ Joysticks

This toggle switch is located at the rear of the joystick housing.

CSPJ Joysticks

This button is located on top of the joystick housing at the rear of the joystick.

Speed Control Knob

The speed control knob is located on the back of the joystick housing. This rotary switch is used for controlling the speed and acceleration of the wheelchair.

1. Turn the switch clockwise to increase the speed of the wheelchair.
2. Turn the switch counterclockwise to decrease the speed of the wheelchair.

Joystick

The joystick has proportional drive control, meaning that further the joystick is pushed from the upright (neutral) position, the faster the wheelchair moves. Your top speed, however, is limited by the setting of the speed-control knob and programmed settings.

To slow the wheelchair to a stop, simply release the joystick. The wheelchair has automatic speed and direction compensation to minimize corrections.

Charger/Programming Input

Located at the front of the joystick housing. This provides easy access for charging the wheelchair batteries. This port also serves as the Remote Programmer Communication connection.

Information Gauge Display

The Information Gauge Display is located on the front of the joystick housing. It provides the following information to the user on the status of the wheelchair -



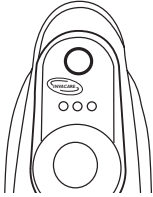
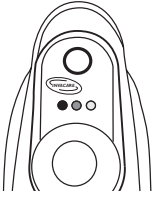
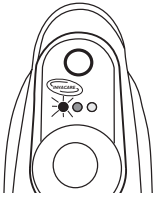
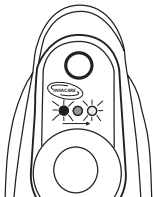
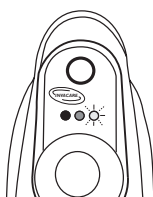
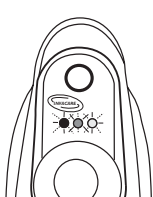
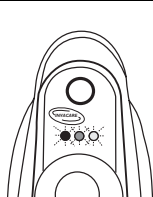

1. Power is on.
2. True state-of-battery-charge, including notification of when the battery requires charging:
 - A. GREEN LED is lit, indicating well charged batteries.
 - B. Only AMBER LEDs are lit, indicating batteries are moderately charged. Recharge batteries before taking a long trip.
 - C. Only RED LED is lit, indicating batteries are running out of charge. Recharge batteries as soon as possible.
3. Program, inhibit or charge modes.
4. Fault indication (Flash Codes).

The Information Gauge display also serves as a system diagnostic device when a fault is detected by the control module. A specific number of flashes of the LEDs indicate the type of fault detected. Refer to the following table of the diagnostic indications of the wheelchair status.

SPJ Diagnostic Indications of Wheelchair Status

DISPLAY	DESCRIPTION	DEFINITION	COMMENTS
	All three LEDs are off.	Power is Off.	
	All three LEDs are on.	Power is On.	Fewer than three LEDs on implies reduced battery charge.
	RED LED is flashing.	Battery charge is low.	The batteries should be charged as soon as possible.
	Left to Right “chase” alternating with steady display.	Joystick is in programming, inhibit and/or charging mode.	The steady LEDs indicate the current state of the battery charge.
	GREEN LED is flashing.	Joystick is in Speed Limit mode.	The current state of battery charge will be displayed at the same time.
	All LEDs are flashing slowly.	Joystick has detected Out-of-Neutral-at-Power-Up mode.	Release the joystick back to Neutral.
	All LEDs are flashing quickly.	Joystick has detected a fault.	Joystick uses Flash codes to indicate faults.

CSPJ Diagnostic Indications of Wheelchair Status

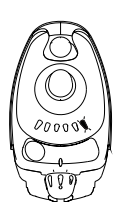
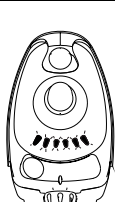
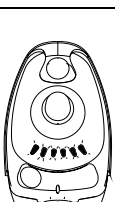
DISPLAY	DESCRIPTION	DEFINITION	COMMENTS
	All LEDs are off.	Power is Off.	
	All LEDs are on.	Power is On.	Fewer than three LEDs on implies reduced battery charge.
	Left RED LED is flashing.	Battery charge is low.	The batteries should be charged as soon as possible.
	Left to Right “chase” alternating with steady display.	Joystick is in programming, inhibit and/or charging mode.	The steady LEDs indicate the current state of the battery charge.
	Right GREEN LED is flashing.	Joystick is in Speed Limit mode.	The current state of battery charge will be displayed at the same time.
	All LEDs are flashing slowly.	Joystick has detected Out-of-Neutral-at-Power-Up mode.	Release the joystick back to Neutral.
	All LEDs are flashing quickly.	Joystick has detected a fault.	Joystick uses Flash codes to indicate faults. Refer to the electronics manual (Part Number 1110532).

SPJ+ and SPJ+ w/ACC Joystick Switches and Indicators

NOTE: For this procedure, refer to FIGURE 4.2.

SPJ+ Joystick

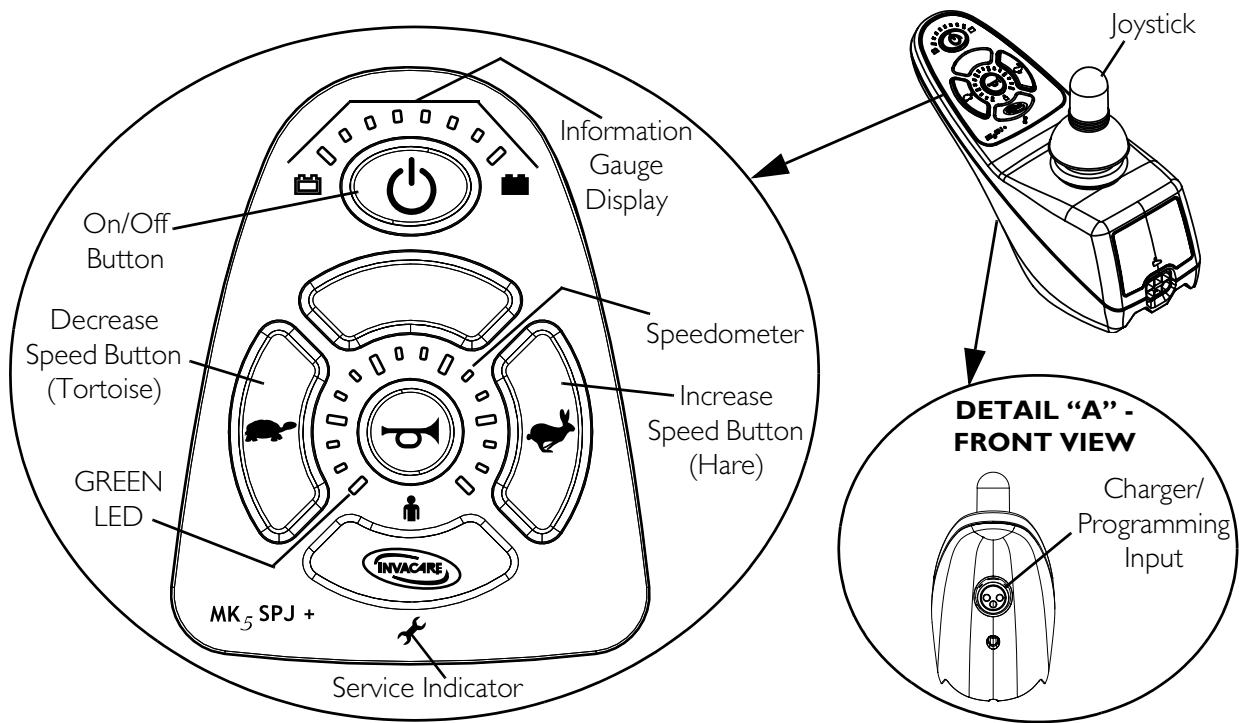

SPJ+ w/ACC Joystick

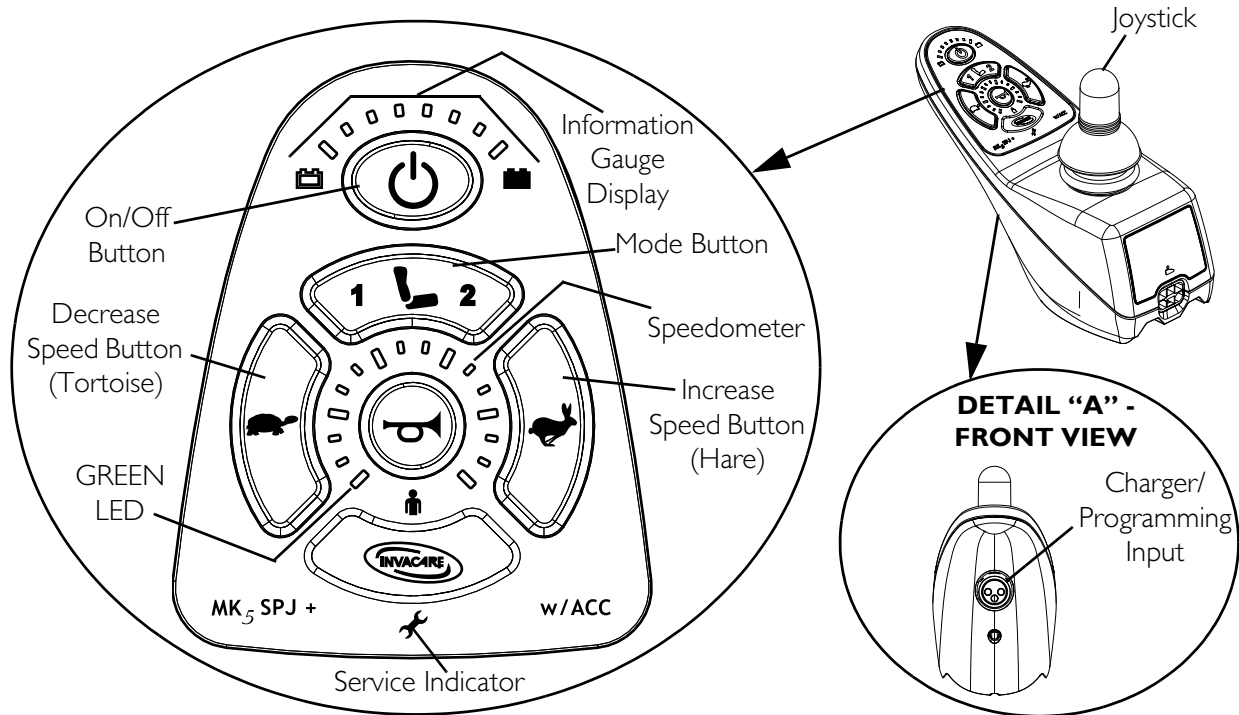

FIGURE 4.2 SPJ+ and SPJ+ w/ACC Joystick Switches and Indicators



On/Off Button









This button is located at the front of the joystick housing. It is used to turn the wheelchair on and off, to remove the joystick from sleep mode (if programmed) and to lock or unlock the joystick (if programmed).

Speedometer

The speedometer is used to show the maximum speed. The right-most LED indicates current maximum speed setting. The bottom left GREEN LED flashes to indicate that the joystick is in speed limit mode. Speed limit mode limits the drive speed to a pre-programmed value, typically when the seat has been elevated and the wheelchair is required to drive at 20% speed.

Speed Control Buttons

The speed control buttons (tortoise button () and hare button () are used to set and adjust the maximum speed.

1. To adjust the speed, perform one of the following:
 - Adjust Speed in 20% Increments (5 Speed Mode) - Press the tortoise button () or hare button () to decrease/increase the speed in 20% increments. The larger bars in the speedometer will light.
 - Adjust Speed in Smaller Increments (VSP Mode) - Perform the following steps:
 - i. Press and hold both the tortoise button () and hare button () until the joystick beeps.
 - ii. Perform one of the following:
 - Press the tortoise button () or hare button () to decrease/increase the speed in 20% increments. The larger bars in the speedometer will light.
 - Press and hold the tortoise button () or hare button () to decrease/increase the speed in smaller increments. The smaller bars in the speedometer will light.

Mode Button

NOTE: The mode button is present on the SPJ+ w/ACC joystick only.

Press the mode button to switch from driving mode to elevate mode. Refer to the wheelchair owner's manual for elevating seat operating instructions.

Joystick

The joystick has proportional drive control, meaning that further the joystick is pushed from the upright (neutral) position, the faster the wheelchair or seat moves. Your top speed, however, is limited by the programmed settings.

To slow the wheelchair to a stop, simply release the joystick. The wheelchair has automatic speed and direction compensation to minimize corrections.

Charger/Programming Input

The charger/programming input is located at the front of the joystick housing. This provides easy access for charging the wheelchair batteries. This port also serves as the Remote Programmer Communication connection. Driving is prevented while the system is charging.

Service Indicator

The AMBER service indicator will light when an error or fault occurs. Refer to [Diagnostic Codes](#) on page 34 for a listing of the flash codes and what they indicate.

Information Gauge Display

Located on the front of the joystick housing, it provides the following information to the user on the status of the wheelchair -

1. Power is on.
2. True state-of-battery-charge, including notification of when the battery requires charging:
 - A. GREEN LEDs are lit, indicating well charged batteries.
 - B. AMBER LEDs are lit, indicating batteries are moderately charged. Recharge batteries before taking a long trip.
 - C. RED LEDs are lit, indicating batteries are running out of charge. Recharge batteries as soon as possible.

The Information Gauge display also serves as a system diagnostic device when a fault is detected by the control module. A specific number of flashes of the LEDs indicate the type of fault detected. Refer to the table for the diagnostic indications of the wheelchair status.

SECTION 4—JOYSTICK DESCRIPTIONS

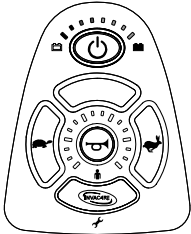
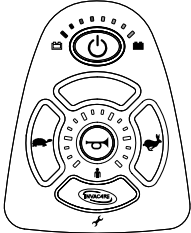
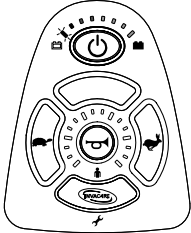
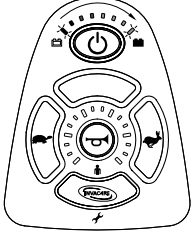
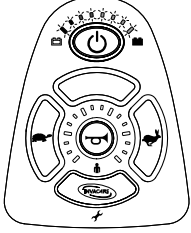

INFORMATION GAUGE DISPLAY	DESCRIPTION	DEFINITION	COMMENTS
	All LEDs are off.	Power is off.	
	All LEDs are on.	Power is on.	Fewer than three LEDs on implies reduced battery charge.
	Left RED LED is flashing.	Battery charge is low.	The batteries should be charged as soon as possible.
	Left to Right “chase” alternating with steady display.	Joystick is in programming, inhibit and/or charging mode.	The steady LEDs indicate the current state of the battery charge.
	All LEDs are flashing slowly.	Joystick has detected Out-of-Neutral-at-Power-Up mode.	Release the joystick back to Neutral.

SECTION 5—PERFORMANCE ADJUSTMENTS

Main Menu

NOTE: For this procedure, refer to FIGURE 5.1.

The first display screen shown after powering on the Remote Programmer is the Main Menu.

The main menu consists of the following options: **Performance Adjust**, **Programs**, **Other**. The arrow to the left is the selection pointer. It can be moved up or down the main menu by pressing the up  or down  key.

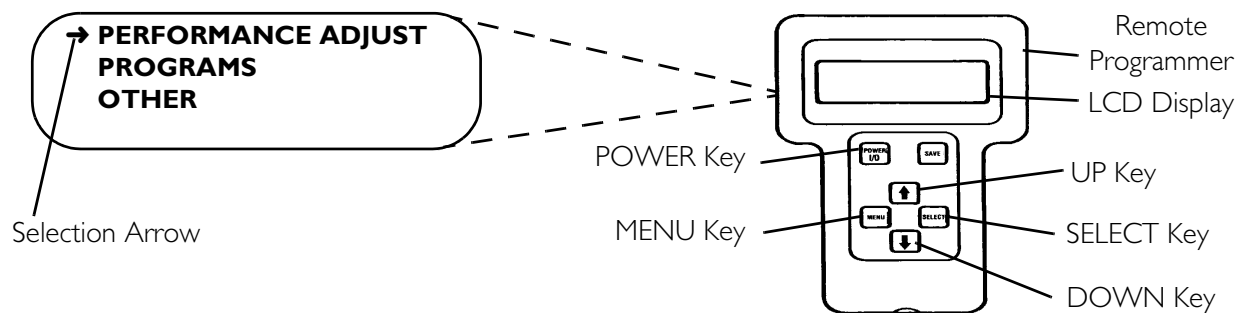

FIGURE 5.1 Main Menu

Performance Adjust Menu

NX, NX-50, NX-75, NX w/ACC, and NX-B

NOTE: For this procedure, refer to FIGURE 5.2.

The Performance Adjust Menu for NX, NX-75, NX w/ACC and NX-B consists of the following:

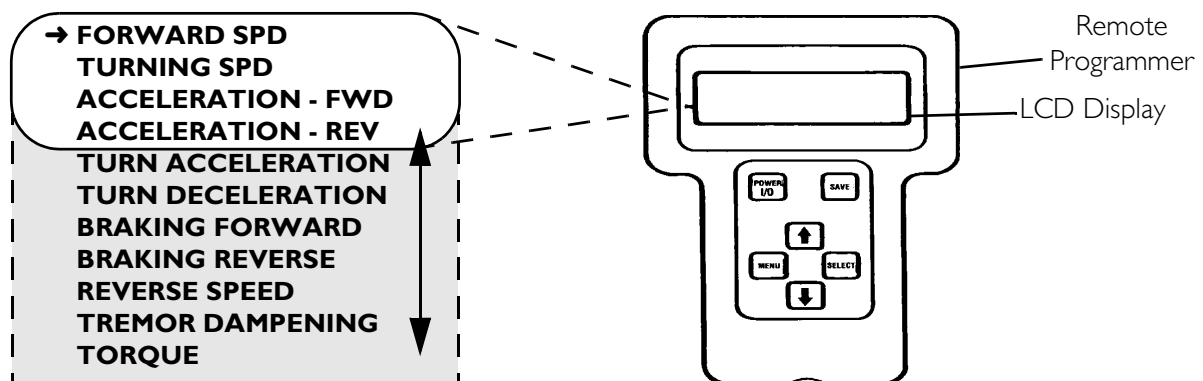

FIGURE 5.2 Performance Adjust Menu - NX, NX-50, NX-75, NX w/ACC, and NX-B

NX-LP

NOTE: For this procedure, refer to FIGURE 5.3.

The Performance Adjust Menu for NX-LP consists of the following:

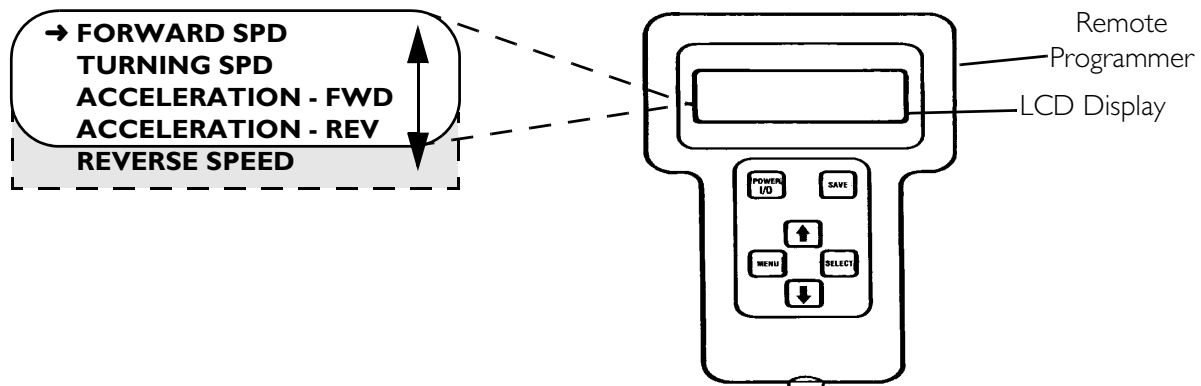

FIGURE 5.3 Performance Adjust Menu - NX-LP

Making Performance Adjustments

⚠ WARNING

DO NOT mismatch a program with the wheelchair type (i.e. selecting a rear wheel drive program for a center wheel drive wheelchair or vice versa). Adverse joystick control of the wheelchair will occur, possibly resulting in serious bodily injury.

NOTE: If unsure if correct program is selected, perform the instructions outlined in [Programs](#) on page 29 before making performance adjustments.

The selection arrow points to PERFORMANCE ADJUST. To select this activity press the SELECT key.



→ PERFORMANCE ADJUST
PROGRAMS
OTHER

The display screen will change to show the first four performance functions and the programmed value for the functions. The selection arrow points to the first function - Forward Speed. Pressing the **↑** or **↓** key will move the selection arrow up or down. Continue pressing the **↑** or **↓** key to cycle through all the options listed in the flowchart in [NX](#), [NX-50](#), [NX-75](#), [NX w/ACC](#), and [NX-B Controller](#) on page 22 or [NX-LP Controller](#) on page 24.



→ FORWARD SPEED
TURNING SPEED
ACCELERATION - FWD
ACCELERATION - REV

To change the programmed value for an option (i.e. Acceleration - FWD), press the  key so the selection arrow points to Acceleration - FWD.

FORWARD SPEED
TURNING SPEED
→ ACCELERATION - FWD
ACCELERATION - REV

Press the SELECT key. The display screen changes to the adjustment screen. The top line shows the function. The second line shows the value. At the bottom is a bar graph which shows the relative position of the current value to the total adjustment range. Pressing the  or  key will adjust the value.

ACCELERATION - FWD
35%
 [■■■■■]

Pressing the  key causes the value to increase and the bar graph to move to the right. Pressing the  key causes the value to decrease and the bar graph to move to the left.

ACCELERATION - FWD
70%
 [■■■■■■]

To save this change, press the SAVE key.

When saving to the drive program is complete, the screen will change to display:

CHANGES SAVED TO
***RWD - 2 POLE**
CONTINUE? PRESS MENU
QUIT? PRESS POWER

**NOTE: The driving program selected is either RWD-2 Pole, RWD - 4 Pole, or CWD 2 - Pole. Refer to the flow chart in [NX](#), [NX-50](#), [NX-75](#), [NX w/ACC](#), and [NX-B Controller](#) on page 22 or [NX-LP Controller](#) on page 24.*

Pressing the MENU key allows the adjustment sequence to be repeated for other driving programs.

NX, NX-50, NX-75, NX w/ACC, and NX-B Controller

Flowchart

NOTE: For this procedure, refer to FIGURE 5.4.

Below is a flowchart on how to use a hand held programmer to select and modify functions.

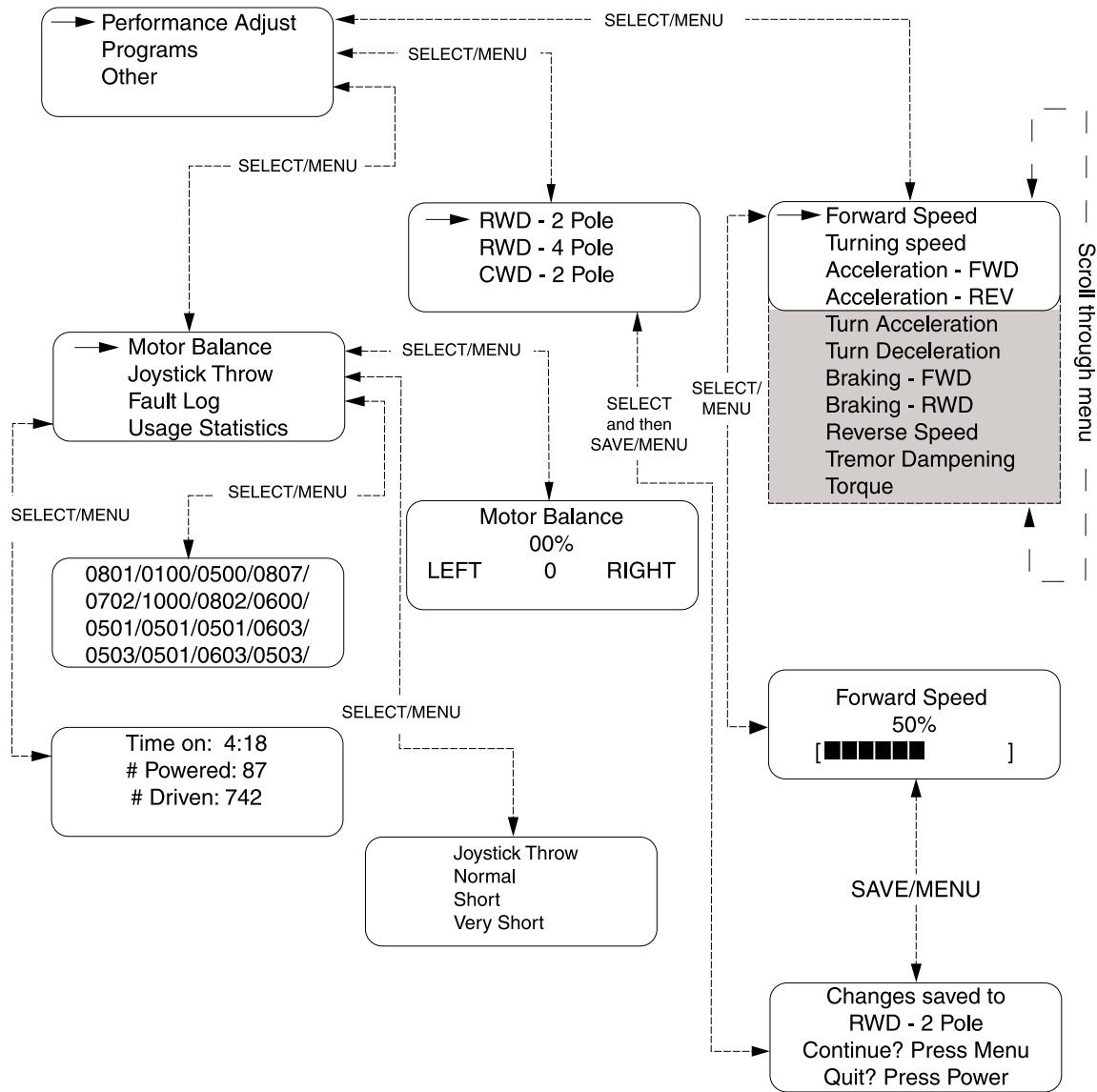





FIGURE 5.4 NX, NX-50, NX-75, NX w/ACC, and NX-B Controller

Performance Menu Description

The performance adjustment menu items are listed below with a description of each function.

MENU ITEM	DESCRIPTION
FORWARD SPEED	Sets the maximum forward speed. The fastest speed setting is 100%. Use the  and  keys to change the value.
TURNING SPEED	Sets the TURNING SPEED as a percentage of the maximum forward speed. The turning speed is independent of the forward speed setting so that the turning speed can be greater than the forward speed. The fastest turning speed setting is 60%. Use the  and  keys to change the value.
ACCELERATION - FWD	ACCELERATION - FWD sets how quickly the controller will accelerate when the joystick is moved forward from neutral.
ACCELERATION - REV	ACCELERATION - REV sets how quickly the controller will accelerate when the joystick is moved to the rear from neutral.
TURN ACCELERATION	TURN ACCELERATION sets how quickly the controller will accelerate when the joystick is moved to the left or right from neutral.
TURN DECELERATION	TURN DECELERATION sets how quickly the controller will decelerate when the joystick is moved to the left or right from neutral.
BRAKING FORWARD	BRAKING FORWARD sets how quickly the controller will decelerate when the joystick is moved toward neutral from a forward position.
BRAKING REVERSE	BRAKING REVERSE sets how quickly the controller will decelerate when the joystick is moved toward neutral from a reverse position.
REVERSE SPEED	The maximum speed the controller will drive with the joystick full reverse and the speed pot fully clockwise.
TREMOR DAMPENING	As the wheelchair approaches a required speed (determined by joystick position) acceleration/deceleration will reduce. A higher value will soften the transition from acceleration/deceleration to that speed.
TORQUE	This parameter allows the controller to compensate appropriately for adverse driving conditions, for example when going over curbs and ramps. It is the parameter that optimizes the driving performance of the controller to the motors being used by setting a specific motor resistance. The controller will not control the wheelchair correctly unless this is carefully set.

NX-LP Controller

Flowchart

NOTE: For this procedure, refer to FIGURE 5.5.

Below is a flowchart on how to use a hand held programmer to select and modify functions.

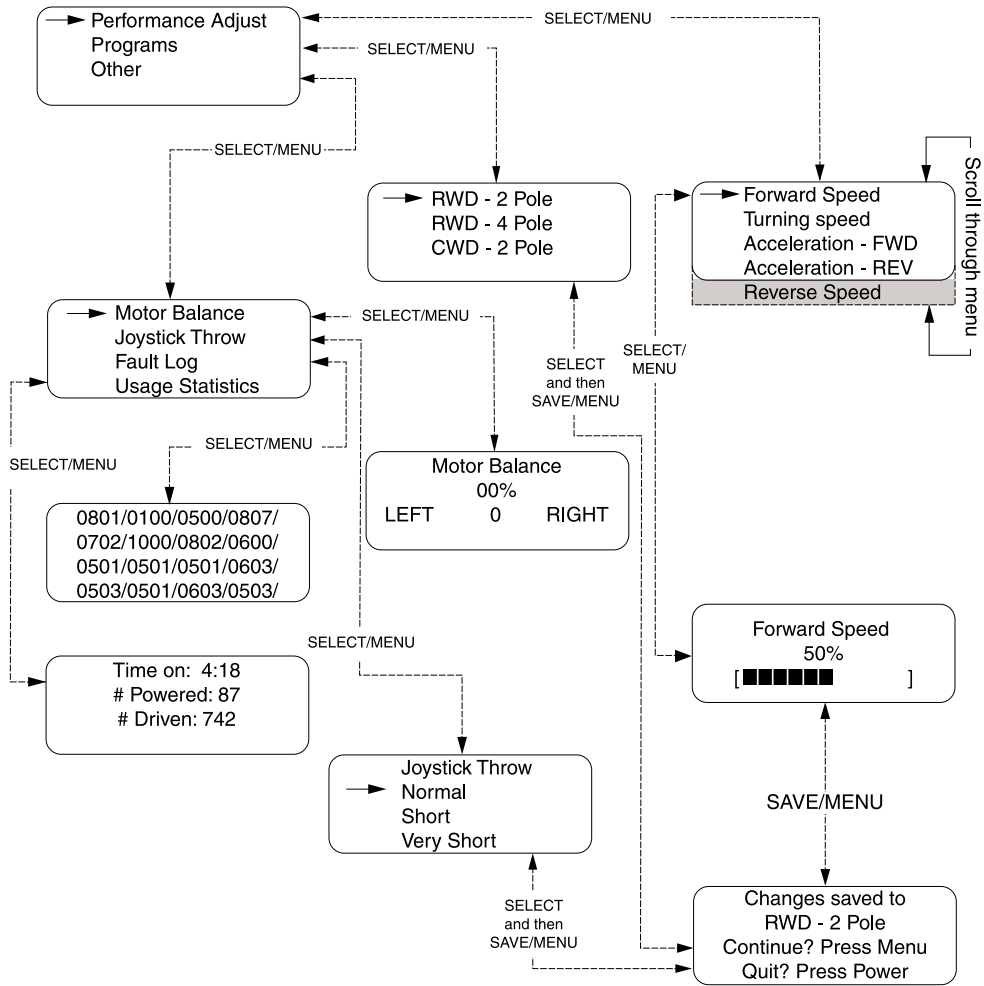

FIGURE 5.5 NX-LP Controller

Performance Menu Description

The performance adjustment menu items are listed below with a description of each function.

MENU ITEM	DESCRIPTION
FORWARD SPEED	Sets the maximum forward speed. The fastest speed setting is 100%. Use the <input type="button" value="↑"/> and <input type="button" value="↓"/> keys to change the value.
TURNING SPEED	Sets the TURNING SPEED as a percentage of the maximum forward speed. The turning speed is independent of the forward speed setting so that the turning speed can be greater than the forward speed. The fastest turning speed setting is 60%. Use the <input type="button" value="↑"/> and <input type="button" value="↓"/> keys to change the value.
ACCELERATION - FWD	ACCELERATION - FWD sets how quickly the controller will accelerate when the joystick is moved forward from neutral.
ACCELERATION - REV	ACCELERATION - REV sets how quickly the controller will accelerate when the joystick is moved to the rear from neutral.
REVERSE SPEED	The maximum speed the controller will drive with the joystick full reverse and the speed pot fully clockwise.

SECTION 6—REMOTE PROGRAMMER

Overview

NOTE: For this procedure, refer to FIGURE 6.1.

The Remote Programmer is the information center of the control module. Through simple key sequences, the Remote Programmer allows modification of the performance characteristics, gives diagnostics information for troubleshooting and permits calibration of the control module.

NOTE: The joystick power switch must be on for the programmer to operate. If the programmer displays “Communication Error”, disconnect the programmer and reconnect it with the joystick turned on.

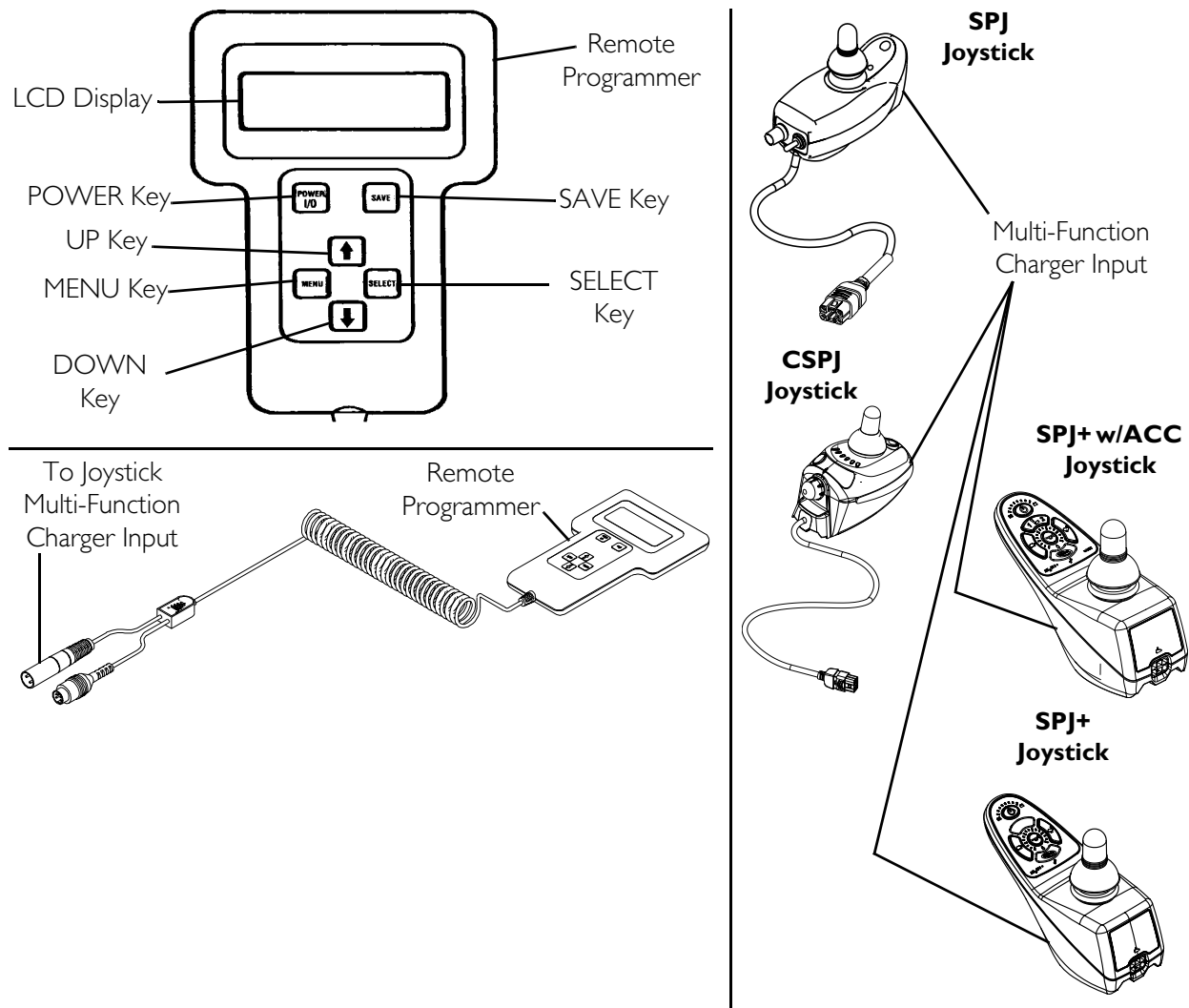

FIGURE 6.1 Overview

Remote Programmer Terminology

Function

A function is a performance characteristic which can be adjusted or modified to improve the operation of the wheelchair for a particular control need. Two examples are:

The forward speed function may be adjusted to a higher or lower speed the same way as you would adjust a trimpot in other controls.

Stand-by Mode Function may be turned ON or OFF the same as a switch would be used. All functions are listed in a menu.

Value

Each function has a value. It is the degree or amount of the function which is used to influence the overall wheelchair performance. Most values are numerical or in percentages, for instance - high speed may be set to 75% of the wheelchair's maximum. For others, the value is either ON or OFF, for example - Stand-by Mode. Changing a value is called Adjustment.

Program (Preset Programs with Standard Value Settings)

The standard programs are fixed function values which are used as an initial set up point from which individualization of the wheelchair performance can begin. Standard values are NEVER altered or modified. Refer to [Programs](#) on page 29.



Temporary Memory

This is the location where function values may be altered to suit individual needs by using the remote programmer. Unless saved, changes to the values in the temporary memory will be erased when the wheelchair power is turned off. Refer to [User Memory Values](#) below.

User Memory Values

User memory is the location where the individualized function values are permanently stored. Each time the power switch is turned on, these values are copied to the temporary memory and are used to control the wheelchair performance. The user memory values can only be changed through the Remote Programmer by first modifying the temporary memory values and then by saving them in the user memory where they become the user program. The Remote Programmer is activated by pressing the POWER key when the wheelchair is in neutral. The wheelchair cannot be driven when the LCD display is illuminated. The display will automatically turn itself OFF after 45 seconds if no keys are pressed. It can also be turned OFF by pressing the POWER key.

Description Of Remote Programmer Keys

KEY	DESCRIPTION
POWER KEY	The POWER key turns on and off the LCD display. Press the POWER key once and the display will come ON. Press the POWER key again and the display will turn OFF.
MENU KEY	The MENU key returns the LCD display to the previous screen. If a function is being adjusted, pressing the MENU key returns the display to the Performance Menu. Pressing the key again will cause the display to change to the Main Menu.
UP  AND DOWN  KEYS	These keys are used to move the selection arrow on the LCD up and down or adjust a value up or down. An adjusted value is not saved unless the SAVE key is pressed.
SELECT KEY	The SELECT key chooses the item to which the selection arrow on the LCD is pointing and displays the appropriate next screen.
SAVE KEY	The SAVE key causes the Save screen to appear or causes the values that have been modified in temporary memory to be permanently stored in the driving program specified by the selection arrow.

SECTION 7—PROGRAMS

Program Settings

⚠ WARNING

DO NOT mismatch a program with the wheelchair type (i.e. selecting a rear wheel drive program for a center wheel drive wheelchair or vice versa). Confirm that the settings and program match the wheelchair before selecting or saving. Otherwise, unintended and unsafe joystick control of the wheelchair will occur, possibly resulting in serious bodily injury.

The program settings are available as a reference point for initial set-up of the wheelchair, for final user setting or whenever major changes have been made in the performance and a known starting point needs to be reestablished. Confirm that the settings and program match the wheelchair before selecting or saving.

Three programs are available.

1. Select PROGRAMS from the main menu to display the standard value menu.
2. Press **↑** or **↓** and then the SELECT key to select the standard program to be placed in the temporary memory.
3. Press the SAVE key to store the program into a selected drive.
4. Make changes to specific functions as needed.

The general capabilities of the standard programs are listed below:

PROGRAMMER READS	DRIVE TYPE	MOTOR TYPE
RWD	Rear Wheel Drive	2-Pole
RWD	Rear Wheel Drive	4-Pole
ATM	Rear Wheel Drive	2-Pole
CWD	Center Wheel Drive	2-Pole
MWD	Center Wheel Drive	2-Pole

NOTE: If the default settings in the following tables are not desired, they will need to be changed manually. Performance Adjustments on page 19.

DEFAULT SETTINGS FOR NX

FUNCTION	PROGRAM 1 RWD 2-POLE	PROGRAM 2 RWD 4-POLE	PROGRAM 3 CWD 2-POLE
FORWARD SPEED	95	90	95
TURNING SPEED	25	20	30
ACCELERATION - FWD	30	25	25
ACCELERATION - REV	30	20	25
TURN ACCELERATION	30	20	25
TURN DECELERATION	35	25	30
BRAKING FORWARD	50	50	50
BRAKING REVERSE	55	45	55
REVERSE SPEED	40	30	40
TREMOR DAMPENING	40	40	40
TORQUE	144	48	144

DEFAULT SETTINGS FOR NX-B

FUNCTION	PROGRAM 1 ATM 2-POLE	PROGRAM 2 RWD 2-POLE	PROGRAM 3 CWD 2-POLE
FORWARD SPEED	95	95	100
TURNING SPEED	50	25	30
ACCELERATION - FWD	30	30	25
ACCELERATION - REV	30	30	25
TURN ACCELERATION	80	30	25
TURN DECELERATION	75	35	30
BRAKING FORWARD	85	50	50
BRAKING REVERSE	55	55	55
REVERSE SPEED	40	40	40
TREMOR DAMPENING	40	40	40
TORQUE	144	144	144

DEFAULT SETTINGS FOR NX-50

FUNCTION	PROGRAM 1 M41-1	PROGRAM 2 M41-2	PROGRAM 3 M41-3
FORWARD SPEED	90	90	90
TURNING SPEED	20	20	20
ACCELERATION - FWD	50	50	50
ACCELERATION - REV	20	20	20
TURN ACCELERATION	20	20	20
TURN DECELERATION	22	22	22
BRAKING FORWARD	50	50	50
BRAKING REVERSE	65	65	65
REVERSE SPEED	40	40	40
TREMOR DAMPENING	35	35	35
TORQUE	48	48	48

DEFAULT SETTINGS FOR NX W/ACC

FUNCTION	PROGRAM 1 MWD - M61 (1)	PROGRAM 2 MWD - M61 (2)	PROGRAM 3 MWD - M61 (3)
FORWARD SPEED	95	95	95
TURNING SPEED	25	25	25
ACCELERATION - FWD	25	25	25
ACCELERATION - REV	25	25	25
TURN ACCELERATION	30	30	30
TURN DECELERATION	30	30	30
BRAKING FORWARD	50	50	50
BRAKING REVERSE	55	55	55
REVERSE SPEED	40	40	40
TREMOR DAMPENING	35	35	35
TORQUE	144	144	144

DEFAULT SETTINGS FOR NX-75



FUNCTION	PROGRAM 1 CWD M9I	PROGRAM 2 CWD M9I HD	PROGRAM 3 CWD M9I
FORWARD SPEED	95	95	95
TURNING SPEED	20	20	20
ACCELERATION - FWD	20	20	20
ACCELERATION - REV	20	20	20
TURN ACCELERATION	25	20	25
TURN DECELERATION	35	20	35
BRAKING FORWARD	50	50	50
BRAKING REVERSE	55	55	55
REVERSE SPEED	50	40	50
TREMOR DAMPENING	35	40	35
TORQUE	36	36	36

DEFAULT SETTINGS FOR NX-LP



FUNCTION	PROGRAM 1 RWD 2-POLE	PROGRAM 2 RWD 4-POLE	PROGRAM 3 CWD 2-POLE
FORWARD SPEED	95	90	100
TURNING SPEED	25	20	30
ACCELERATION - FWD	30	25	25
ACCELERATION - REV	30	20	25
REVERSE SPEED	40	30	40

SECTION 8—OTHER FUNCTIONS

Description of Other Functions

Select OTHER from the main menu to display Motor Balance, Joystick Throw, Fault Log, and Usage Statistics. Use the  and  keys to select the function desired. The SELECT key will display the current value and permit modifications. Always press SAVE after changes are made.

NOTE: At any point, press the MENU key to return to the previous screen.

MENU ITEM	DESCRIPTION
MOTOR BALANCE	Motor balance corrects for veer when going straight on level ground. To correct for a veer to the right, move the bar graph indicator to the right using the  key. To correct for veer to the left, move the bar graph indicator to the left using the  key.
JOYSTICK THROW	Joystick throw calibration is used to calibrate the neutral position and the full speed travel of the proportional joystick. The control module stores the maximum displacement of the joystick and later, during driving, uses the values to generate a full speed command whenever that displacement is reached. Exceeding this displacement does not product further increase in speed. The result of this method of calibration is a customized driving template.
FAULT LOG	The Fault Log shows the fault codes that have been detected by the diagnostic system since the control was built in the factory. The fault codes correspond to the Diagnostics Codes given in the next section. The Fault Log can be used by the service technician to uncover the cause of intermittent faults that are not evident when the wheelchair is being serviced. <i>NOTE: It is normal to have some codes in the Fault Log, even in a new wheelchair, because they are generated during factory testing and calibration.</i>
USAGE STATISTICS	The usage statistics screen displays how long the wheelchair has been on in hours: minutes, the total number of times the wheelchair has been powered up and how many times the wheelchair has been driven.

SECTION 9—DIAGNOSTIC CODES

What Are Diagnostics Codes?

The joystick information gauge and the Remote Programmer give indications of the type of fault or error detected by the control module. When a fault is detected, the wheelchair will stop and not drive. All of the lights on the information gauge will begin to flash (SPJ and CSPJ joysticks) or the service indicator light will flash (SPJ+ and SPJ+ w/ACC joystick). The number of flashes indicates the nature of an abnormal condition. An error code and a quick description of the fault will begin to scroll across the Remote Programmer display. If multiple faults are found, only the first fault encountered by the control module program will be displayed. Refer to the Power Wheelchair Service Manual for detailed troubleshooting and repair instructions. A table of the diagnostics codes and their causes follows.

**NOTE: The fault log displays a four digit number. The first two digits are the diagnostic code and the remaining two digits are the sub code.*

NUMBER OF FLASHES	DIAGNOSTICS CODE	ERROR CODE DESCRIPTION	SUB CODE*	DETAILS OF ERROR CODE	POSSIBLE SOLUTION
1	E 01	User Fault	00	Stall Timeout or user error.	Release joystick to neutral and try again.
2	E02	Battery Fault	00	Recharge batteries or replace.	Check the batteries and cable. Try charging the batteries. Batteries may require replacing.
3	E03	Left Motor Fault	00	Left Motor Short Circuit	Check the left motor, connections and motor cable.
			01	Left Motor Open Circuit	
			02	Left Motor Connection Fault B-	
			03	Motor Terminal Connected to B+	
			04	Left Motor Voltage Fault	
			05	Left Motor Bridge Fault	
			06	Too Many Hardware Current Limit Events	
			07	Current Offset Out of Range	
			08	Hardware Current Limit Fault	

NUMBER OF FLASHES	DIAGNOSTICS CODE	ERROR CODE DESCRIPTION	SUB CODE*	DETAILS OF ERROR CODE	POSSIBLE SOLUTION
4	E04	Right Motor Fault	00	Right Motor Short Circuit	Check the right motor, connections and motor cable.
			01	Right Motor Open Circuit	
			02	Right Motor Connection Fault B-	
			03	Motor Terminal Connected to B+	
			04	Right Motor Voltage Fault	
			05	Right Motor Bridge Fault	
			06	Too Many Hardware Current Limit Events	
			07	Current Offset Out of Range	
			08	Hardware Current Limit Fault	
5	E05	Left Park Brake Fault	00	Left Park Brake Drive-Time Test Failed	Check the left park brake connections and cable.
			01	Left Park Brake Output Enabled When Wheelchair Idle	
			02	Left Park Brake Output Did not Enable When Entering Drive Mode	
			03	Left Park Brake fault during power-up testing	
			04	Left park brake feedback low during drive (park brake short)	
6	E06	Right Park Brake Fault	00	Right Park Brake Drive-Time Test Failed	Check the right park brake connections and cable.
			01	Right Park Brake Output Enabled When Wheelchair Idle	
			02	Right Park Brake Output Did not Enable When Entering Drive Mode	
			03	Right Park Brake fault during power-up testing	
			04	Right park brake feedback low during drive (park brake short)	

SECTION 9—DIAGNOSTIC CODES

NUMBER OF FLASHES	DIAGNOSTICS CODE	ERROR CODE DESCRIPTION	SUB CODE*	DETAILS OF ERROR CODE	POSSIBLE SOLUTION
7	E07	Remote Fault	00	Local SR Fault (CPU, EEPROM, etc.)	Check the communications bus, connections and wiring. Replace the remote.
			01	Joystick fault at the remote	
			02	Speed pot fault at the remote	
8	E08	Controller Fault	00	Controller fault	Check connections and wiring. Replace power module.
			01	RAM fault	
			02	ROM fault	
			03	CPU fault	
			04	EEPROM fault	
			05	Watchdog fault	
			06	Stack fault	
			07	Software fault	
			08	Power-up testing fault	
			09	Relay fault or precharge fault	
			10	Bridge fault or disable all fault	
			11	Electronics fault: Thermistor	
			12	Calibration setting fault	
9	E09	Communications Fault	00	Remote connection lost	Check connections and wiring. Replace Bus cable.
			01	Low communication mode	
10	E10	General Fault	00	General fault	Check all connections and wiring. Contact Invacare Technical Service.
11	E11	Incompatible/incorrect Remote	00	Incompatible/incorrect Remote	Wrong type of remote connected. Ensure the branding of the joystick matches that of controller unit.

SECTION 10—CONNECTOR DESCRIPTIONS

Controller Connector Descriptions

NX, NX-50, NX-75, NX-B and NX-LP

NOTE: For this procedure, refer to FIGURE 10.1.

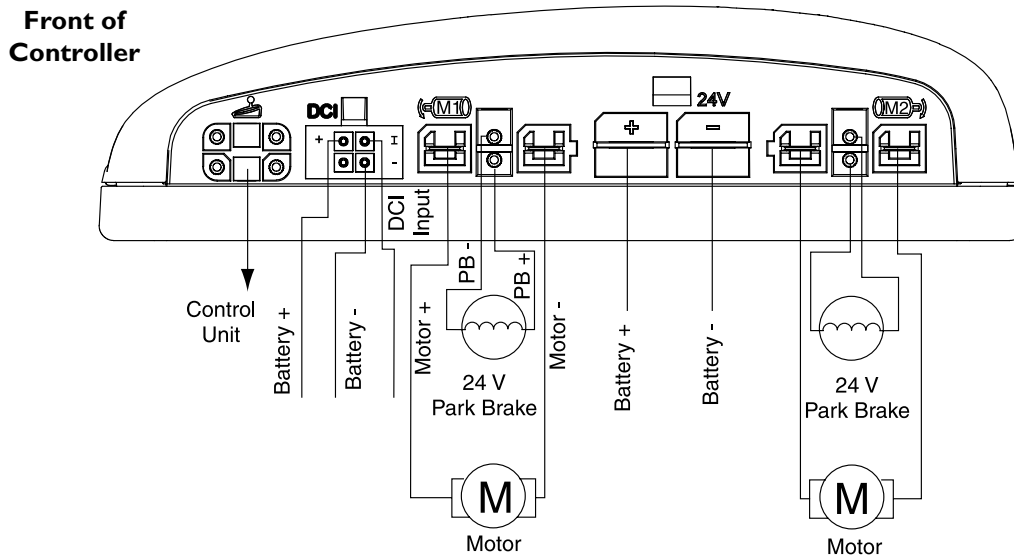

FIGURE 10.1 NX, NX-50, NX-75, NX-b and NX-LP

NX w/ACC

NOTE: For this procedure, refer to FIGURE 10.2.

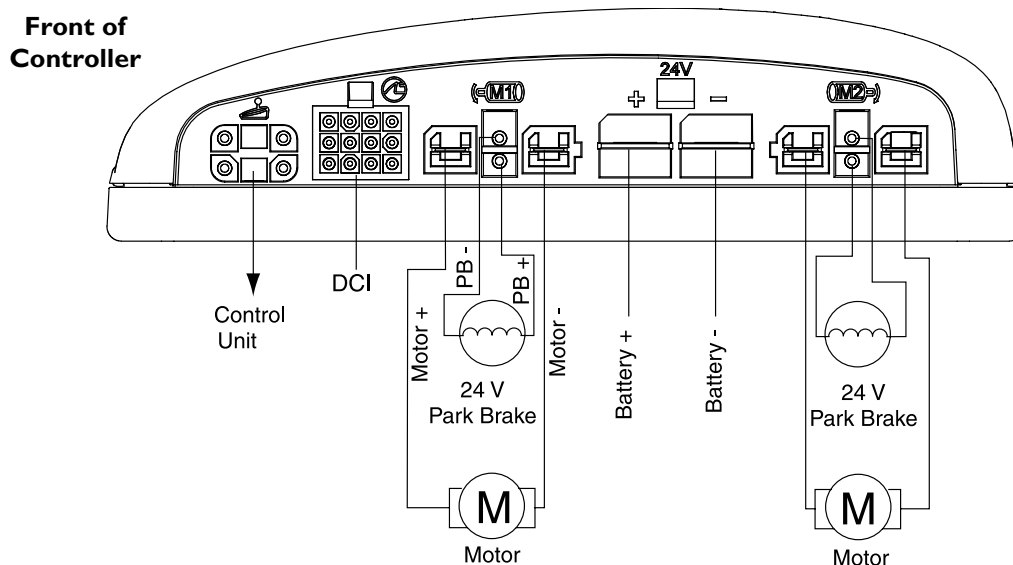

FIGURE 10.2 NX w/ACC

Battery Connector Pinout

NOTE: For this procedure, refer to FIGURE 10.3.

PIN	FUNCTION
1	Battery Positive
2	Battery Negative

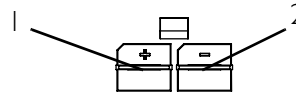

FIGURE 10.3 Battery Connector Pinout

Motor Connector Pinout

NOTE: For this procedure, refer to FIGURE 10.4.

PIN	FUNCTION
1	Motor Positive
2	Motor Negative
3	Park Brake Negative
4	Park Brake Positive

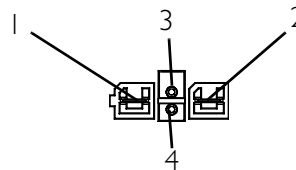

FIGURE 10.4 Motor Connector Pinout

Joystick Connector Pinout

NOTE: For this procedure, refer to FIGURE 10.5.

PIN	FUNCTION
1	Battery Positive
2	Communication Bus High
3	Communication Bus Low
4	Battery Negative

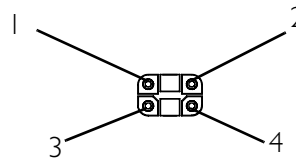

FIGURE 10.5 Joystick Connector Pinout

Drive Control Input (DCI)

NOTE: Wheelchairs equipped with DCI have seating options (i.e. elevate and tilt).

The DCI allows the wheelchair mode to depend on the resistance of the DCI “Loop”:

- Inhibit - prevents the wheelchair from driving, typically when the wheelchair is being charged, or when the seat is tilted.
- Slow - limits the drive speed to a predetermined value, typically when the seat is raised.

To determine the mode, an appropriate resistance must be placed across the DCI input pin (I) and the DCI Battery Negative (-) pin. Depending on the resistance value, the controller will inhibit, slow, and/or swivel driving. Resistors used must be 5% tolerance resistors.

MODE	RESISTANCE
Inhibit	0
Slow	120
Normal	Open

NX, NX-50, NX-75, NX-B, and NX-LP

NOTE: For this procedure, refer to FIGURE 10.6.

PIN	FUNCTION
1	Battery Positive
2	DCI Input (Drive Lockout)
3	--No Connection--
4	Battery Negative

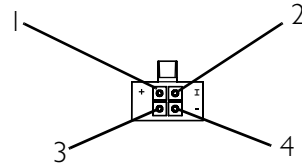

FIGURE 10.6 NX, NX-50, NX-75, nx-b, and NX-LP

NX w/ACC

NOTE: For this procedure, refer to FIGURE 10.7.

PIN	FUNCTION
1	Actuator 1 Negative
2	Actuator 1 Positive
3	n/a
4	n/a
5	Actuator 2 Negative
6	Drive Control Input (Drive Lockout)
7	Battery Positive
8	n/a
9	Actuator 2 Positive
10	Battery Negative
11	-- No Connection --

PIN	FUNCTION
12	n/a

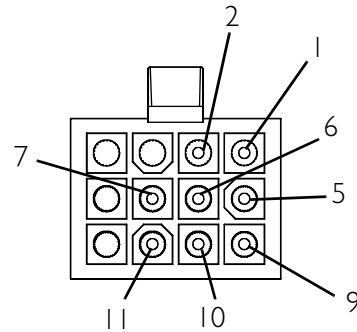

FIGURE 10.7 NX w/ACC

Battery Charger Port

NOTE: For this procedure, refer to FIGURE 10.8.

PIN	FUNCTION
1	Battery Positive
2	Battery Negative
3	Serial Data/DCI Input

Front of
Joystick

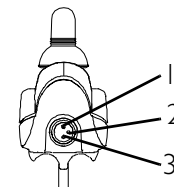

FIGURE 10.8 Motor Connector Pinout

LIMITED WARRANTY

PLEASE NOTE: THE WARRANTY BELOW HAS BEEN DRAFTED TO COMPLY WITH FEDERAL LAW APPLICABLE TO PRODUCTS MANUFACTURED AFTER JULY 4, 1975.

This warranty is extended only to the original purchaser/user of our products.

This warranty gives you specific legal rights and you may also have other legal rights which vary from state to state.

Invacare warrants the **NX, NX-50, NX-75, NX-LP, NX-B** and **NX w/ACC Controller** to be free from defects in materials and workmanship for a period of one year from date of purchase. If within such warranty period any such product shall be proven to be defective, such product shall be repaired or replaced, at Invacare's option. This warranty does not include any labor or shipping charges incurred in replacement part installation or repair of any such product. Invacare's sole obligation and your exclusive remedy under this warranty shall be limited to such repair and/or replacement.

For warranty service, please contact the dealer from whom you purchased your Invacare product. In the event you do not receive satisfactory warranty service, please write directly to Invacare at the address at the bottom of the back cover. Provide dealer's name, address, date of purchase, indicate nature of the defect and, if the product is serialized, indicate the serial number. Do not return products to our factory without our prior consent.

LIMITATIONS AND EXCLUSIONS: THE FOREGOING WARRANTY SHALL NOT APPLY TO SERIAL NUMBERED PRODUCTS IF THE SERIAL NUMBER HAS BEEN REMOVED OR DEFACED, PRODUCTS SUBJECT TO NEGLIGENCE, ACCIDENT, IMPROPER OPERATION, MAINTENANCE OR STORAGE, COMMERCIAL OR INSTITUTIONAL USE, PRODUCTS MODIFIED WITHOUT INVACARE'S EXPRESS WRITTEN CONSENT INCLUDING, BUT NOT LIMITED TO, MODIFICATION THROUGH THE USE OF UNAUTHORIZED PARTS OR ATTACHMENTS; PRODUCTS DAMAGED BY REASON OF REPAIRS MADE TO ANY COMPONENT WITHOUT THE SPECIFIC CONSENT OF INVACARE, OR TO A PRODUCT DAMAGED BY CIRCUMSTANCES BEYOND INVACARE'S CONTROL, AND SUCH EVALUATION WILL BE SOLELY DETERMINED BY INVACARE. THE WARRANTY SHALL NOT APPLY TO PROBLEMS ARISING FROM NORMAL WEAR OR FAILURE TO ADHERE TO THESE INSTRUCTIONS.

THE FOREGOING EXPRESS WARRANTY IS EXCLUSIVE AND IN LIEU OF ANY OTHER WARRANTIES WHATSOEVER, WHETHER EXPRESS OR IMPLIED, INCLUDING THE IMPLIED WARRANTIES OF MERCHANTABILITY AND FITNESS FOR A PARTICULAR PURPOSE, AND THE SOLE REMEDY FOR VIOLATIONS OF ANY WARRANTY WHATSOEVER, SHALL BE LIMITED TO REPAIR OR REPLACEMENT OF THE DEFECTIVE PRODUCT PURSUANT TO THE TERMS CONTAINED HEREIN. THE APPLICATION OF ANY IMPLIED WARRANTY WHATSOEVER SHALL NOT EXTEND BEYOND THE DURATION OF THE EXPRESS WARRANTY PROVIDED HEREIN. INVACARE SHALL NOT BE LIABLE FOR ANY CONSEQUENTIAL OR INCIDENTAL DAMAGES WHATSOEVER.

THIS WARRANTY SHALL BE EXTENDED TO COMPLY WITH STATE/PROVINCIAL LAWS AND REQUIREMENTS.



Yes, you can.™

Invacare Corporation www.invacare.com

USA
One Invacare Way
Elyria, Ohio USA
44036-2125
800-333-6900

Canada
570 Matheson Blvd E Unit 8
Mississauga Ontario
L4Z 4G4 Canada
800-668-5324

Invacare, Yes, you can. and the Medallion Design are registered trademarks of Invacare Corporation. MK₅, NX, SPJ and CSPJ are trademarks of Invacare Corporation.
© 2006 Invacare Corporation

Part No 1110532

Rev G - 08/16/06