

# FURUNO

# OPERATOR'S MANUAL

VHF RADIOTELEPHONE

---

MODEL FM-8700

---



**FURUNO ELECTRIC CO., LTD.**  
NISHINOMIYA, JAPAN

© **FURUNO ELECTRIC CO., LTD.**

9-52, Ashihara-cho,  
Nishinomiya, Japan

Telephone: 0798-65-2111  
Telefax: 0798-65-4200

•Your Local Agent/Dealer

All rights reserved. Printed in Japan

FIRST EDITION : APR. 1998  
K1 : JUL. 3, 2002

(YOSH) PUB. No. OME-56170  
FM-8700



\* 00080827701 \*



\* OME56170K10 \*

# CANCELING DISTRESS ALERT

If less than five seconds has elapsed since the [DISTRESS] key was pressed, the distress alert may be canceled by pressing the [ALARM STOP] key. Otherwise, do the following:

1. Switch off equipment immediately.
2. Switch equipment on and set to Channel 16.
3. Transmit message to "All Stations" giving your vessel's name, callsign and DSC number to cancel the distress alert.

## **Example message:**

All Stations, All Stations, All Stations  
This is VESSEL'S NAME, CALLSIGN,  
DSC NUMBER, POSITION.

Cancel my distress alert of  
DATE, TIME, UTC.  
=Master, VESSEL'S NAME, CALLSIGN.  
DSC NUMBER, DATE, TIME UTC.



# SAFETY INSTRUCTIONS

## **WARNING**



**Do not open the equipment.**

Hazardous voltage which can cause electrical shock, burn or serious injury exists inside the equipment. Only qualified personnel should work inside the equipment.

**Do not disassemble or modify the equipment.**

Fire, electrical shock or serious injury can result.

**Turn off the power immediately if water leaks into the equipment or the equipment is emitting smoke or fire.**

Continued use of the equipment can cause fire or electrical shock.

**Do not place liquid-filled containers on the top of the equipment.**

Fire or electrical shock can result if a liquid spills into the equipment.

**Do not operate the equipment with wet hands.**

Electrical shock can result.

**Keep heater away from equipment.**

Heat can alter equipment shape and melt the power cord, which can cause fire or electrical shock.

**Any repair work must be done by a licensed radio technician.**

Improper repair work can cause electrical shock or fire.

## **CAUTION**

**Do not touch any part of the antenna when the equipment is transmitting.**

Electrical shock can result.

**Use the proper fuse.**

Use of a wrong fuse can result in fire or permanent equipment damage.

**Do not use the equipment for other than its intended purpose.**

Personal injury can result if the equipment is used as a chair or stepping stool, for example.

**Do not place objects on the top of the equipment.**

The equipment can overheat or personal injury can result if the object falls.

# TABLE OF CONTENTS

---

<b>FOREWORD</b> .....	v
-----------------------	---

<b>SYSTEM CONFIGURATION</b> .....	vii
-----------------------------------	-----

## **1. VHF RADIOTELEPHONE OPERATIONAL OVERVIEW**

1.1 Front Panel .....	1-1
1.2 VHF Controls, Indications .....	1-2
1.3 Turning the Power On/Off .....	1-2
1.4 Selecting Channel Modes, Channels .....	1-3
1.5 Adjusting Volume of Loudspeaker .....	1-3
1.6 Adjusting Squelch, Selecting Operating Functions .....	1-3
1.7 Transmitting .....	1-4
1.8 Selecting Output Power .....	1-4
1.9 Turning the Loudspeaker On/Off .....	1-4
1.10 Automatic Selection of CH16 .....	1-4
1.11 Dual Watch .....	1-5
1.12 Scanning .....	1-5
1.13 Remarks on Voice Communications .....	1-6

## **2. DSC TERMINAL OPERATIONAL OVERVIEW**

2.1 DSC Controls, LED Warnings .....	2-1
2.2 DSC Operational Overview .....	2-4
2.3 Turning Remote & Auto Acknowledge On/Off .....	2-7

## **3. DSC DISTRESS COMMUNICATIONS**

3.1 Distress Alert Transmission .....	3-1
3.2 Manual Entry of Own Ship's Position and Time .....	3-3
3.3 Canceling a Distress Call .....	3-4
3.4 Receiving Distress Alert from Other Vessel, Transmitting DIST ACK Signal .....	3-5
3.5 Distress Alert Relay .....	3-9

## **4. DSC OPERATION FOR NON-DISTRESS CASES**

4.1 Transmitting Individual Calls .....	4-1
4.2 Receiving Individual Calls (ACK RQ) .....	4-5
4.3 Transmitting All Ships Calls .....	4-9
4.4 Receiving All Ships Calls .....	4-12

4.5 Preparing and Saving Messages .....	4-16
4.6 Writing Over Files .....	4-18
4.7 Opening, Transmitting Files .....	4-19
4.8 Transmit/Receive Message Memory .....	4-20

## 5. OTHER CALLING TYPES

5.1 Selection of Other Calling Types .....	5-1
5.2 Making Telephone Calls .....	5-3
5.3 Receiving Telephone Call from Coast Station .....	5-6
5.4 Other Station IDs and Telephone Numbers .....	5-7

## 6. USER PREFERENCES

6.1 Automatic or Manual Printing (Printer setup) .....	6-1
6.2 Turning Key Beep On/Off .....	6-4
6.3 Alarm Setup .....	6-5

## 7. SYSTEM CONFIRMATION

7.1 Confirming Own Ship's ID .....	7-1
7.2 Confirming ROM Version No. ....	7-2
7.3 Confirming VHF Section Settings .....	7-3
7.4 Confirming VHF Channels .....	7-4
7.5 Confirming Tx Output Power .....	7-5

## 8. MAINTENANCE & TROUBLESHOOTING

8.1 Maintenance .....	8-1
8.2 Troubleshooting .....	8-1
8.3 Diagnostic Test .....	8-2

## SPECIFICATIONS ..... SP-1

## APPENDIX ..... A-1

Menu Tree .....	A-1
Marine VHF Channel Lists .....	A-4
Digital Interface (IEC 61162-1 Edition 2).....	A-9

## INDEX ..... Index-1

## Declaration of conformity to type

# FOREWORD

---

## A Word to FM-8700 Owners

Congratulations on your choice of the FURUNO FM-8700 VHF Radiotelephone. We are confident you will see why the FURUNO name has become synonymous with quality and reliability.

For over 40 years FURUNO Electric Company has enjoyed an enviable reputation for quality marine electronics equipment. This dedication to excellence is furthered by our extensive global network of agents and dealers.

This equipment is designed and constructed to meet the rigorous demands of the marine environment. However, no machine can perform its intended function unless operated and maintained properly. Please carefully read and follow the recommended procedures for operation and maintenance.

We would appreciate hearing from you, the end-user, about whether we are achieving our purposes.

Thank you for considering and purchasing FURUNO equipment.

# Features

The FURUNO FM-8700 is a cost-effective all-in-one marine VHF radio system consisting of a 25 W VHF radiotelephone, a DSC modem, a CH 70 watch receiver, and a duplexer unit. It complies with GMDSS carriage requirements for safety and general communications.

The FM-8700 offers simplex/ full-duplex voice communications on ITU channels in the marine mobile VHF band. The features include Dual Watch which allows a continuous watch on CH16 and another selected frequency.

Full Class-A DSC functions are provided for distress alert transmission and reception, as well as the general call formats (Individual telephone, All Ships, Group and Area Call). Distress alert can be readily transmitted but an arrangement is provided to prevent accidental activation. The FM-8700 maintains a continuous watch on CH70 even while another VHF channel is in use. Aural and visual alarms are given to incoming DSC messages.

The main features of the FM-8700 are

- Compact cabinet allows for flexible and space-saving installation on a navigation console or at the conning position
- Conforms to the following standards and regulations:
  - IMO A. 694(17)
  - IMO A. 803(19)
  - IMO A. 524(13)
  - IMO MSC 68(68), MSC/Circ.862
  - IEC-61097-3/7/8
  - IEC-60945 (3rd edition)
  - IEC-61162-1
  - ETS 300 338, 301 033, 300 162
  - ITU-R M.493-9, M.541-8, M.689-2
- Full-duplex communications
- Precision PLL frequency synthesizer for high frequency stability as required for DSC operation
- Dual Watch and Multiple Watch
- Continuous DSC watch on CH70
- Prevention of accidental distress alert
- File editing for emergency readiness
- Automatic entry of own ship position with manual override

## Program number

DSC 0550192004 (version 1.06)  
RT 0550193004 (version 1.04)



# SYSTEM CONFIGURATION

The FM-8700 is a highly advanced, full-duplex, fully synthesized 25 W VHF transceiver with DSC terminal. It is designed to satisfy the stringent requirements of marine communications, and complies with GMDSS carriage requirements for safety and general communications.

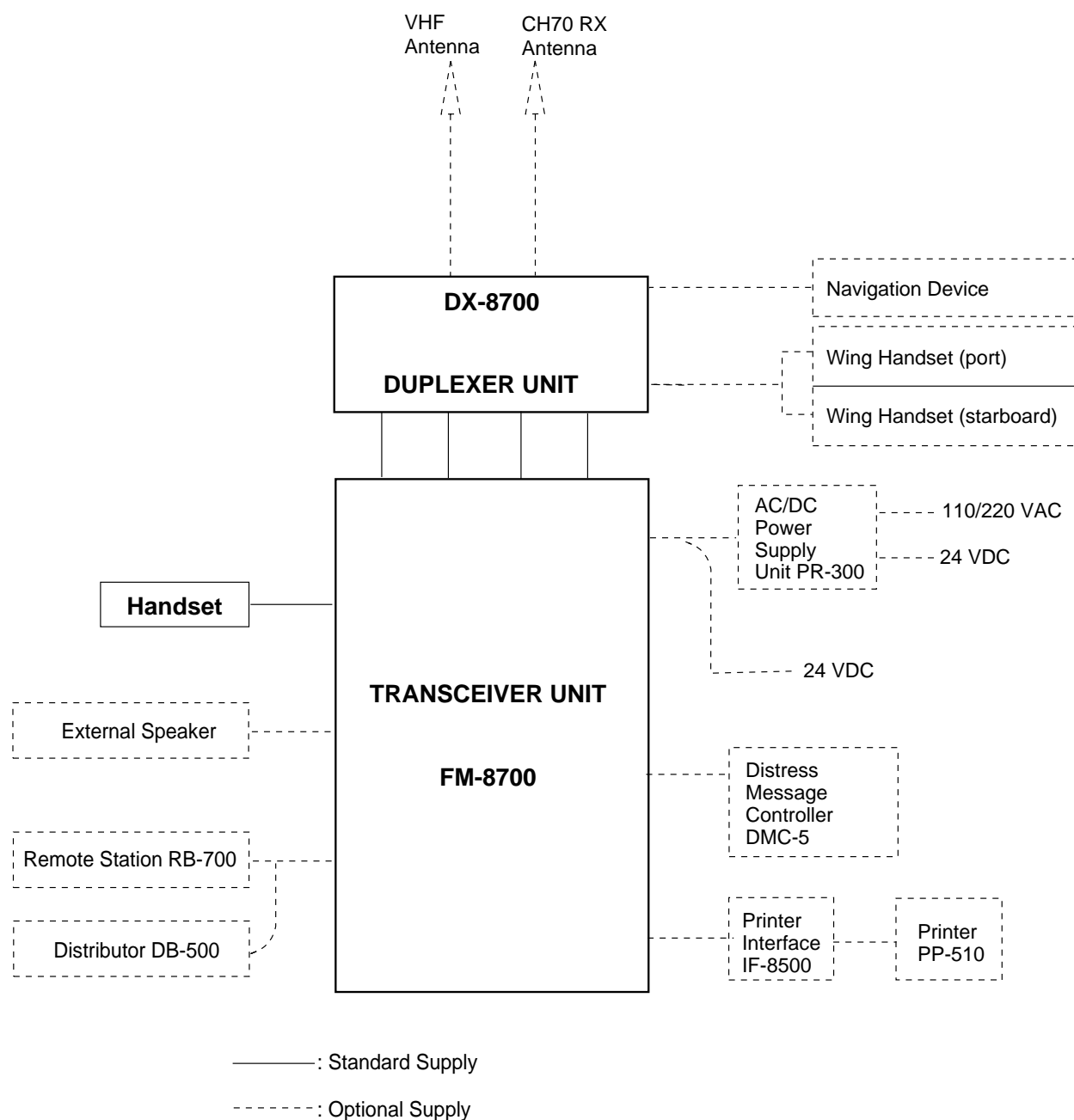

Figure 1 FM-8700 system configuration

This page is intentionally left blank.

# 1. VHF RADIOTELEPHONE OPERATIONAL OVERVIEW

The FM-8700 system consists of a transceiver unit, a duplexer unit and two antennas. The transceiver unit contains a VHF transmitter, receiver, and channel 70 watch receiver module. All operations are controlled on its front panel.

## 1.1 Front Panel

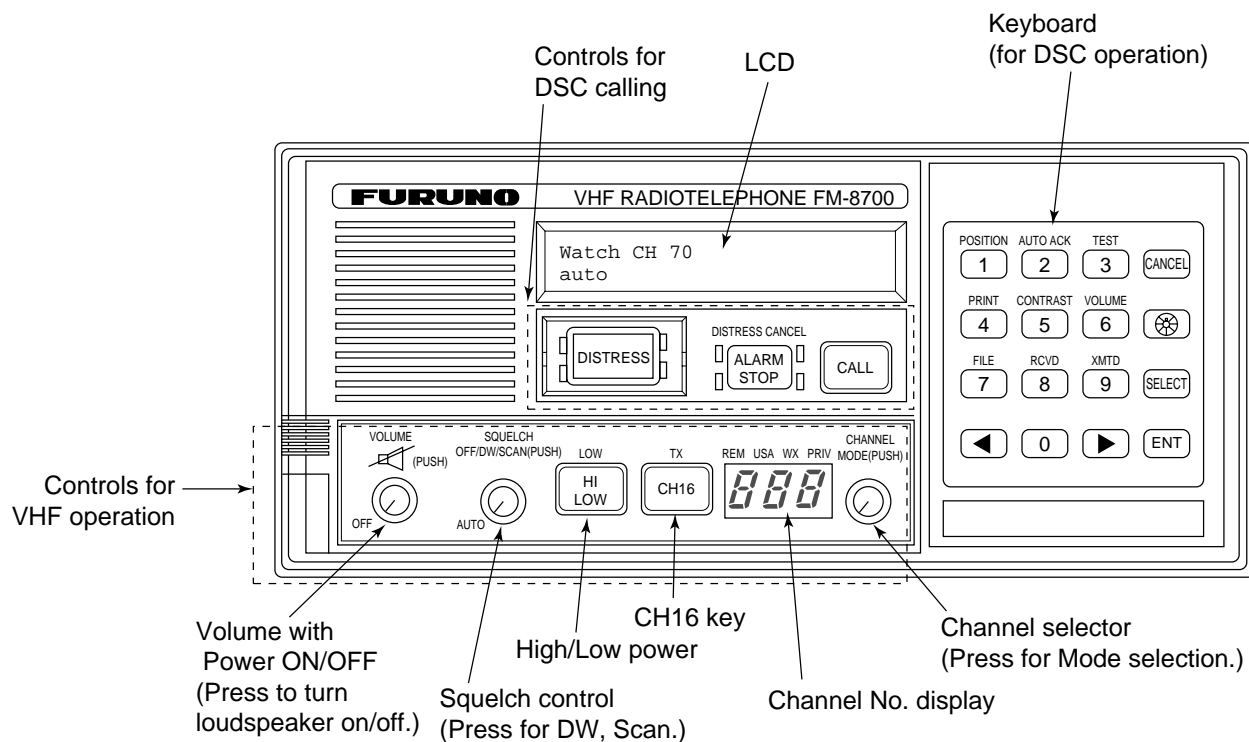



Figure 1-1 FM-8700 transceiver unit

## 1.2 VHF Controls, Indications

Control	Function
CHANNEL/ MODE	CHANNEL (Rotary control): Selects a channel. MODE (Push): Changes modes in order of INTL, USA, WX and PRIV. (USA, WX and PRIV modes available where permitted.)
SQUELCH/ DW/SCAN	SQUELCH (Rotary control): Mutes the receiver when no signal is present on the channel selected. AUTO position automatically reduces white noise. DW/SCAN (Push): Changes the operating function in order of Dual Watch, Scan and Off.
VOLUME	Rotation turns the power on/off and adjusts the volume of the loudspeaker. Pressing turns off the internal loudspeaker.
HI/LOW key	Alternates high and low output power.
CH16 key	Selects channel 16.
Indication	Meaning
	Internal loudspeaker OFF by pressing the VOLUME control. Internal loudspeaker is automatically turned off whenever the handset is set in its rest.
LOW	Lights RF power is LOW.
TX	Lights while transmitting.
REM	Lights when FM-8700 is being controlled by Remote Station RB-700.
USA	USA mode. (Some ITU duplex channels are used as simplex channels.)
WX	Lights when a weather channel is selected. (Available in USA version.)
DW/SCAN	DW for Dual Watch; SCAN for scanning.

## 1.3 Turning the Power On/Off

To turn the power on, turn the VOLUME control clockwise until you hear a click. To turn the power off, turn the control fully counterclockwise until you hear the click.

## 1.4 Selecting Channel Modes, Channels

### Selecting channel modes

While pressing the CHANNEL selector, press the CH16 key to select the channel mode: International, USA (in the case of USA channel permitted), private (if authorized), or weather mode (USA channel permitted). The International version of the FM-8700 has no such selection.

On the weather channel mode, a beep is emitted when the weather alert tone is received.

**Note:** Private channels are available only where permitted by the authorities.

### Selecting channels

Rotate the CHANNEL selector clockwise (counterclockwise) to display desired channel in the channel No. display window.

## 1.5 Adjusting Volume of Loudspeaker

The VOLUME control adjusts the volume of the loudspeaker.

## 1.6 Adjusting Squelch, Selecting Operating Functions

### Adjusting squelch

The SQUELCH control adjusts the squelch threshold level. Adjust it so that white noise heard in the loudspeaker just fades out. Perform this operation when no traffic is being received. AUTO squelch automatically reduces white noise. Usually select the AUTO position. Avoid turning the squelch too far clockwise – you may miss a long distance communication.

**Note:** To obtain correct scan watch/dual watch response, adjust the SQUELCH control precisely.

### Selecting operating function

Every pressing of the SQUELCH control changes the operating function as follows:

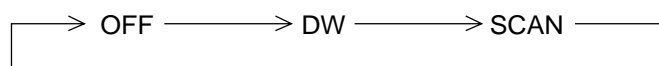

## 1.7 Transmitting

Press the PTT (Press-to-talk) switch on the handset or microphone to talk, and release it to listen for the response. The VHF section keyboard accepts no key input when the PTT switch is operated.

### Remarks on transmitting

- Before transmitting, think about the subjects which have to be communicated and, if necessary, prepare written notes to avoid unnecessary interruptions and ensure that no valuable time is wasted on a busy channel.
- Listen before commencing to transmit to make certain that the channel is not already in use.

## 1.8 Selecting Output Power

Each press of the [HI/LOW] key selects HI or LOW output power. LOW appears when low power is selected. The transmitter power is automatically set for low on the following channels:

International: CH15, CH17

USA: CH13, CH15, CH17, CH67; to operate USA channel 13 or 67 in high power, keep [HI/LOW] pressed while talking into the handset.

## 1.9 Turning the Loudspeaker On/Off

To turn the loudspeaker on/off, press the VOLUME control. The loudspeaker off mark appears when the speaker is off. The loudspeaker is automatically turned off when the telephone handset is used on semi-duplex channels.

## 1.10 Automatic Selection of CH16

Press the [CH16] key to select CH16, the International Calling and Safety Channel. The use is limited to distress, safety and calling. The transmission on CH16 (156.800 MHz) should be limited to within 1 minute except for distress calling.

Avoid calling on CH16 for purposes other than distress, urgency and very brief safety communications when another calling channel is available.

## 1.11 Dual Watch

The dual watch function permits watch on CH16 and another selected channel. CH16 and another channel are watched at intervals of 0.15 seconds and one second, respectively.

To start DW, first select the other frequency to watch and then press the SQUELCH control. When the receiver finds a signal on CH16, it locks on it and restarts dual watching after the signal on CH16 has gone. If another channel has traffic, it still continues dual watch. The speech is heard intermittently. If you are annoyed with the intermittence, turn off DW by pressing the PTT switch on the handset or pressing the SQUELCH control.

## 1.12 Scanning

The receiver scans all channels in the selected channel mode in ascending channel order, watching CH16 between channels as below:

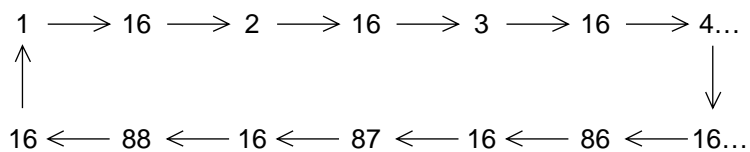

To start scanning, press the SQUELCH control. When the receiver finds a signal, scanning is stopped on that channel and starts dual watch on it and CH16.

## 1.13 Remarks on Voice Communications

Automatic acknowledge (DSC operation) is automatically changed to manual acknowledge when voice communications begin. (The “auto” indication, however, remains on the screen.) This is done to prevent break in communications. Automatic acknowledge is automatically restored once voice communications are terminated.

### Priority

The priority of the equipment is as follows: DSC section of FM-8700>Wing handset>Handset of FM-8700>Remote Station RB-700

---

### Note: Time-out Timer

The FM-8700 is equipped with an automatic timing device that deactivates the transmitter and reverts the transceiver to the receive mode after an uninterrupted transmission period of 5 minutes. Please contact your dealer if necessary.



# 2. DSC TERMINAL OPERATIONAL OVERVIEW

Digital Selective Calling (DSC) is the globally adapted system by the ITU-R and IMO for selective calling of coast station and ship radio stations. The DSC system is used for both safety and routine. The GMDSS requires the use of DSC for distress alerting and safety calls.

## 2.1 DSC Controls, LED Warnings

### DSC controls

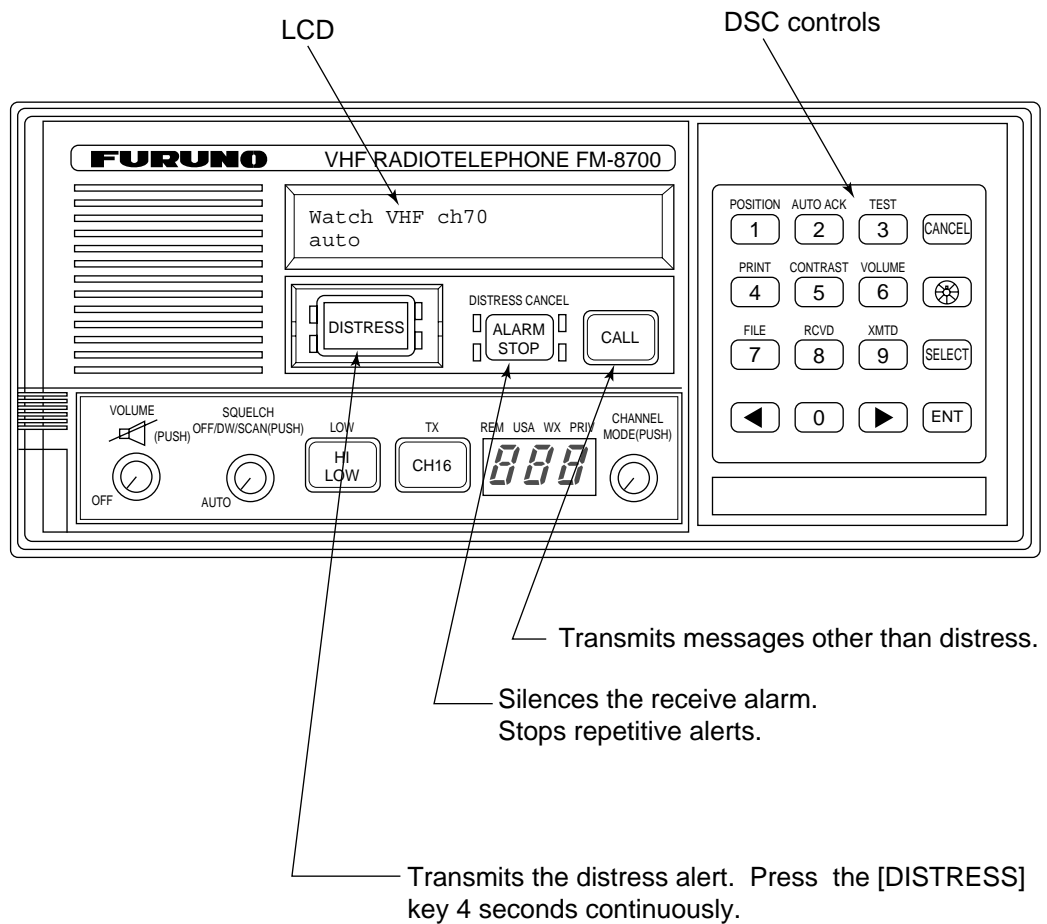
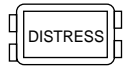

Figure 2-1 FM-8700 transceiver unit

## LED warnings



The four LEDs surrounding the [DISTRESS] key light continuously when the distress signal is transmitted.



- The upper two of the four LEDs surrounding the [ALARM STOP] key blink (and alarm sounds) when distress or urgent message is received. LEDs can be extinguished and alarm silenced by pressing the [ALARM STOP] key.
- The lower two LEDs (Green) blink (and alarm sounds) when message other than distress/urgent are received. Alarm is automatically silenced five seconds after message is received.

## DSC control description

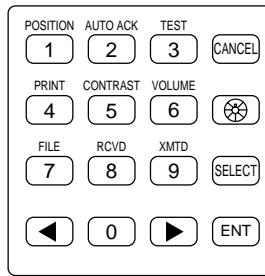

*Figure 2-2 DSC keyboard*

Key	Function/Purpose
0 ~ 9	Enter numeric data.
CANCEL	Cancels wrong data and restores previous menu.
	Adjusts illumination of LED and keys in four levels.
SELECT	1. Displays Set up menu (Main menu). 2. Changes settings of items appearing with blinking question mark.
ENT	Registers key input. (Blinking item is registered when key is pressed.)
	1. Shifts the cursor leftward. 2. Restores previous display when pressed at displays with a blinking question mark.
	Shifts the cursor rightward.
POSITION 1	Position and time are shown while pressed and held down.
AUTO ACK 2	Turns automatic transmission of acknowledge call (AUTO ACK) on/off. (Refer to page 2-8.) Note that distress alert cannot be automatically acknowledged by "auto acknowledge."
TEST 3	Conducts self-tests.
PRINT 4	Printing. (Also sets up automatic printing.)
CONTRAST 5	Adjusts contrast of LCD in eight levels.
FILE 7	Opens files.
RCVD 8	Displays contents of received messages. (Storage capacity: 100 files, 50 each of distress and other.) (Refer to page 4-20.)
XMTD 9	Displays contents of transmitted messages. (Storage capacity: 50 files.) (Refer to page 4-20.)
VOLUME 6	Not used.

## 2.2 DSC Operational Overview

### Standby display

When the FM-8700 is turned on, the following display appears. This display is known as the “standby display.” This is where you will begin most operations.

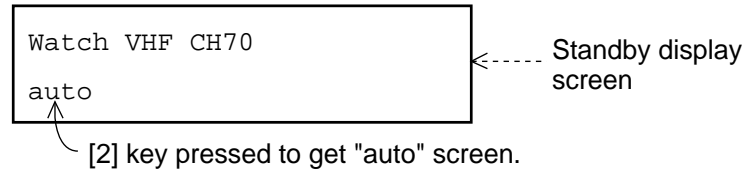

Should you get lost in operation you can return to the standby display by pressing the [CANCEL] key several times.

### Selecting and registering items

The arrow keys ([◀] and [▶]) function to select items on the LCD. After selecting item, press the [ENT] key to register it.

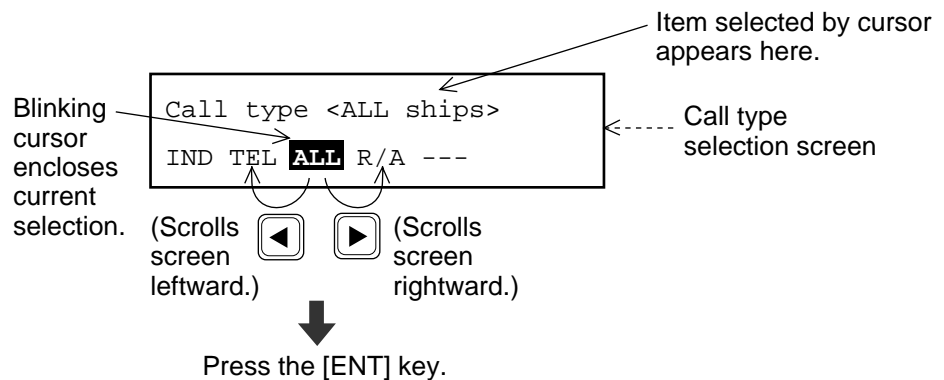

### When blinking question mark appears

Press the [ENT] or [SELECT] key depending on your desire.

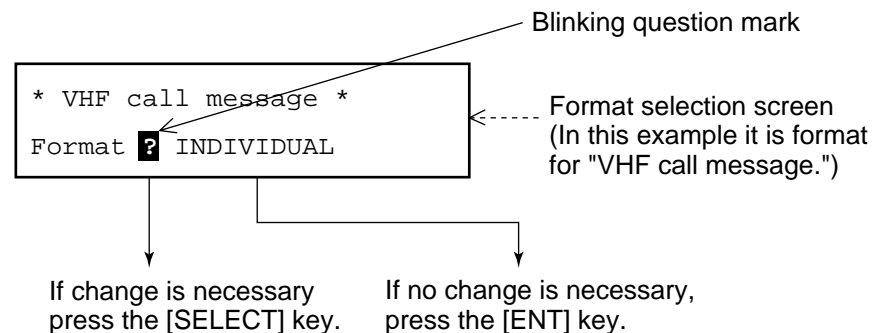

## Preparing and transmitting DSC messages

There are two methods by which you can prepare and transmit DSC messages, and they are shown below.

### Preparing message for immediate transmission

Prepare message and then transmit it as follows:

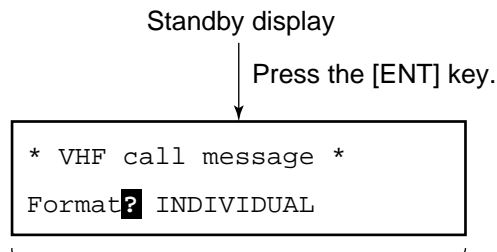

For how to prepare a DSC message, refer to page 4-1.

After preparation, press the [CALL] key to transmit the DSC message.

### Transmitting a message stored in the memory

99 messages (excluding distress message) can be saved to the memory. You may open a memory-stored message and transmit it as follows:

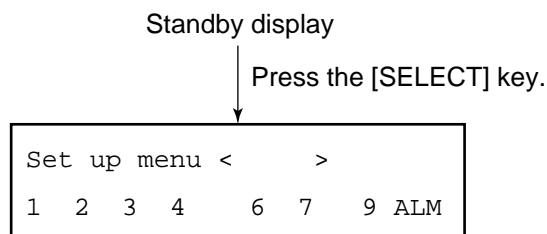

Press the [7] key.

For how to prepare and store a message, refer to "4.5 Preparing and Saving Messages."

After the standby display appears, press keys in the order shown below to transmit a DSC messages.

Press the [7] key. → (Enter file number.) → Press the [CALL] key.

### **Distress alert transmission and output power**

When the distress alert is transmitted (by pressing the [DISTRESS] key), the output power of the FM-8700 is automatically set to maximum (25 W).

### **When keyboard input is prohibited**

The DSC section keyboard accepts no key input while a DSC message is being transmitted. (DSC keyboard is inoperative about 3 seconds during a DSC distress call; 0.5 seconds for other DSC calls.)

## 2.3 Turning Remote & Auto Acknowledge On/Off

To enable or disable AUTO ACK and remote control, press the [2] key. Each press of the key enables or disables automatic acknowledge and remote control function in the sequence shown below.

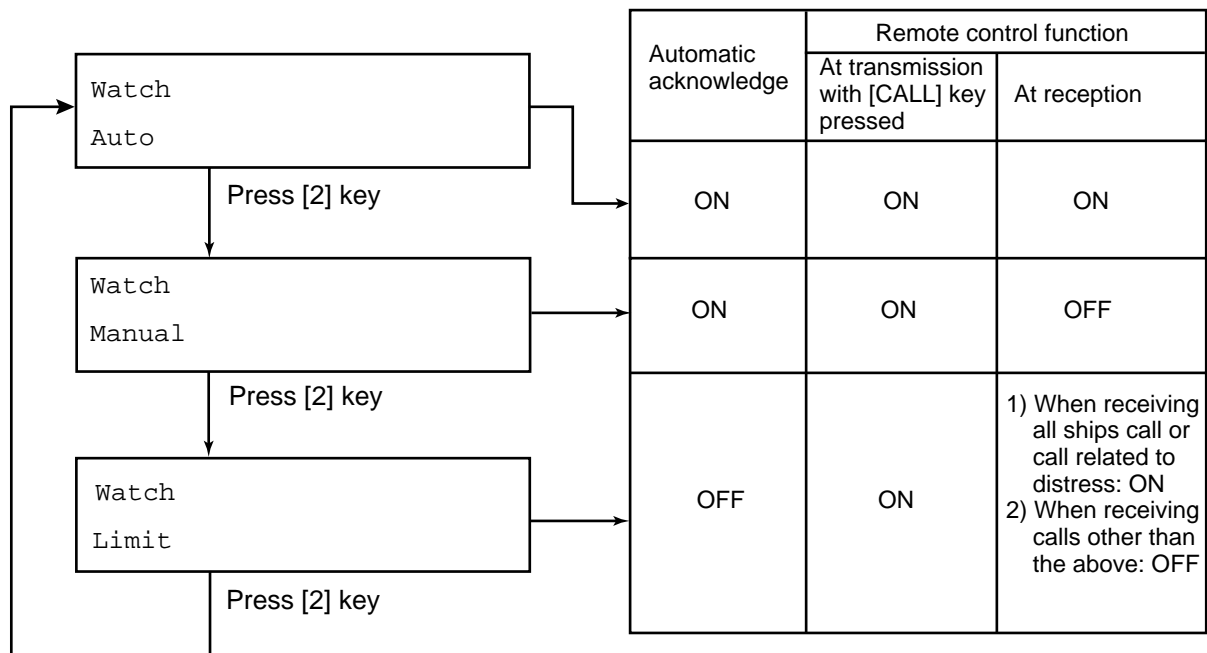

### Limit acknowledge

The limit setting provides restricted use of the remote control function. It is useful when the following is desired:

- Automatically set a working channel when receiving an All Ships call so as not to miss initial voice from the transmitting station.
- Prevent automatic transmission of acknowledge back (ACK BQ) in response to an individual call, when no operator is present.
- Prevent automatic transmission of own ship position data in response to an individual call which requests such data.

### Auto acknowledge is automatically disabled when...

- An Error Checking Code (ECC) appears at the end of a receive message.
- A distress alert is received. (A distress alert cannot be acknowledged automatically.)
- Conducting voice communications.

This page is intentionally left blank.



# 3. DSC DISTRESS COMMUNICATIONS

## 3.1 Distress Alert Transmission

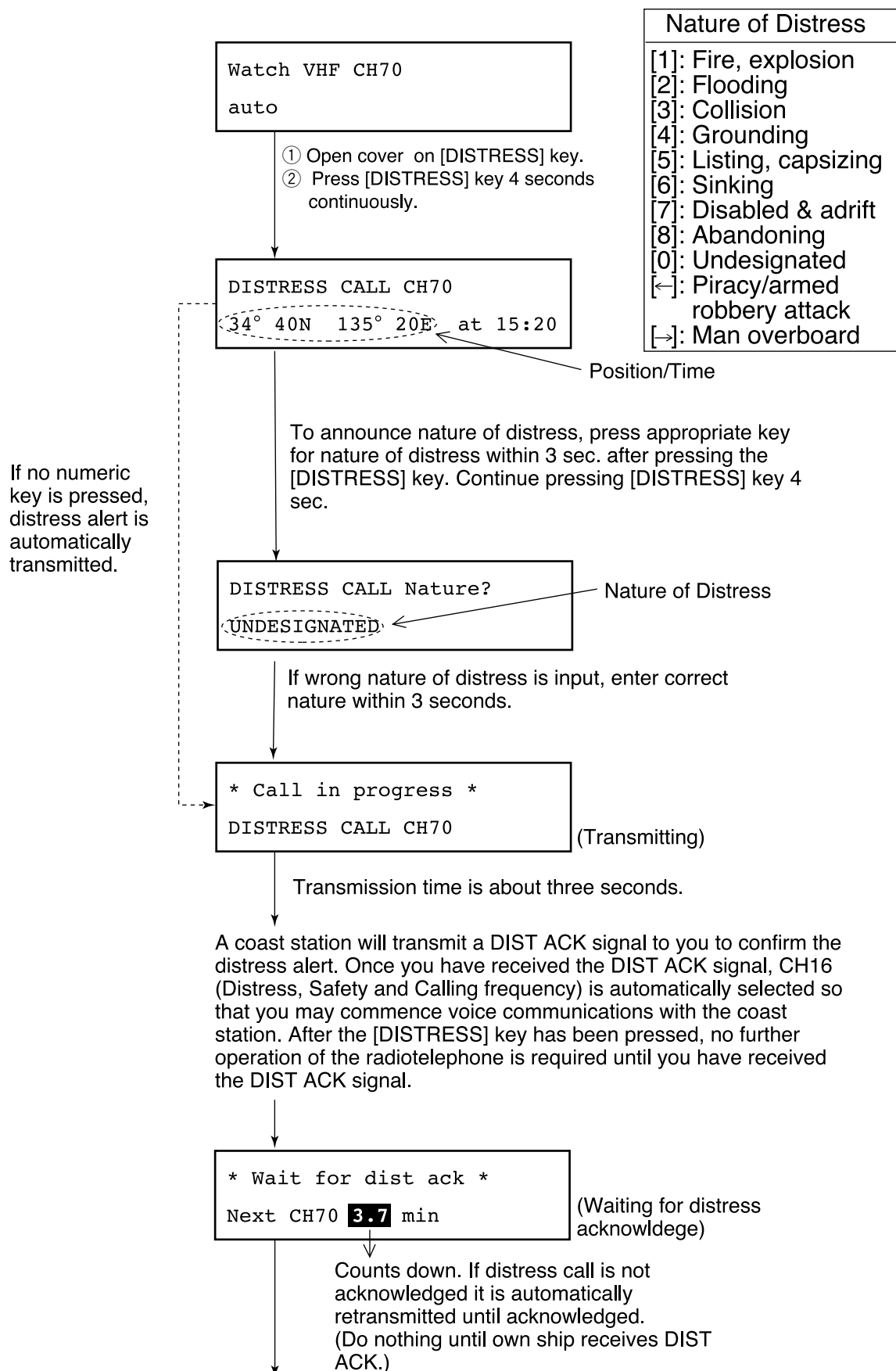

Nature of Distress	
[1]:	Fire, explosion
[2]:	Flooding
[3]:	Collision
[4]:	Grounding
[5]:	Listing, capsizing
[6]:	Sinking
[7]:	Disabled & adrift
[8]:	Abandoning
[0]:	Undesignated
[←]:	Piracy/armed robbery attack
[→]:	Man overboard

(continued on next page)

(from previous page)

\* Received \* DISTRESS ACK  
ID : 001234567

ID of station (usually coast station)  
which transmitted DIST ACK.

Commence voice communications with coast station on CH16.

1. Provide the following information to the coast station:

**Distress call**

- (1) Speak slowly and distinctly, “MAYDAY, MAYDAY, MAYDAY,” pronounced as the French expression “m’aider.”
- (2) This is;
- (3) The name of your vessel and call sign three times.

Then, begin the distress communications, which consists of:

**Distress communications**

- (1) Position in latitude and longitude;
- (2) The name of the distress;
- (3) The kind of assistance desired;
- (4) Any other information which might facilitate rescue, for example, length, color, and type of vessel, number of persons on board.

2. Indicate the end of message by saying “Over.”

Some countries do not have sea area A. In this case “ACK” from the coast station does not arrive over DSC. A ship nearby will contact the vessel in distress over CH16. After transmitting the distress alert, conduct voice distress communications as shown above.

## 3.2 Manual Entry of Ship's Position and Time

### Entering data manually

If automatic position input is lost for one minute the message "EPFS error" appears. In this case, enter position manually as below.

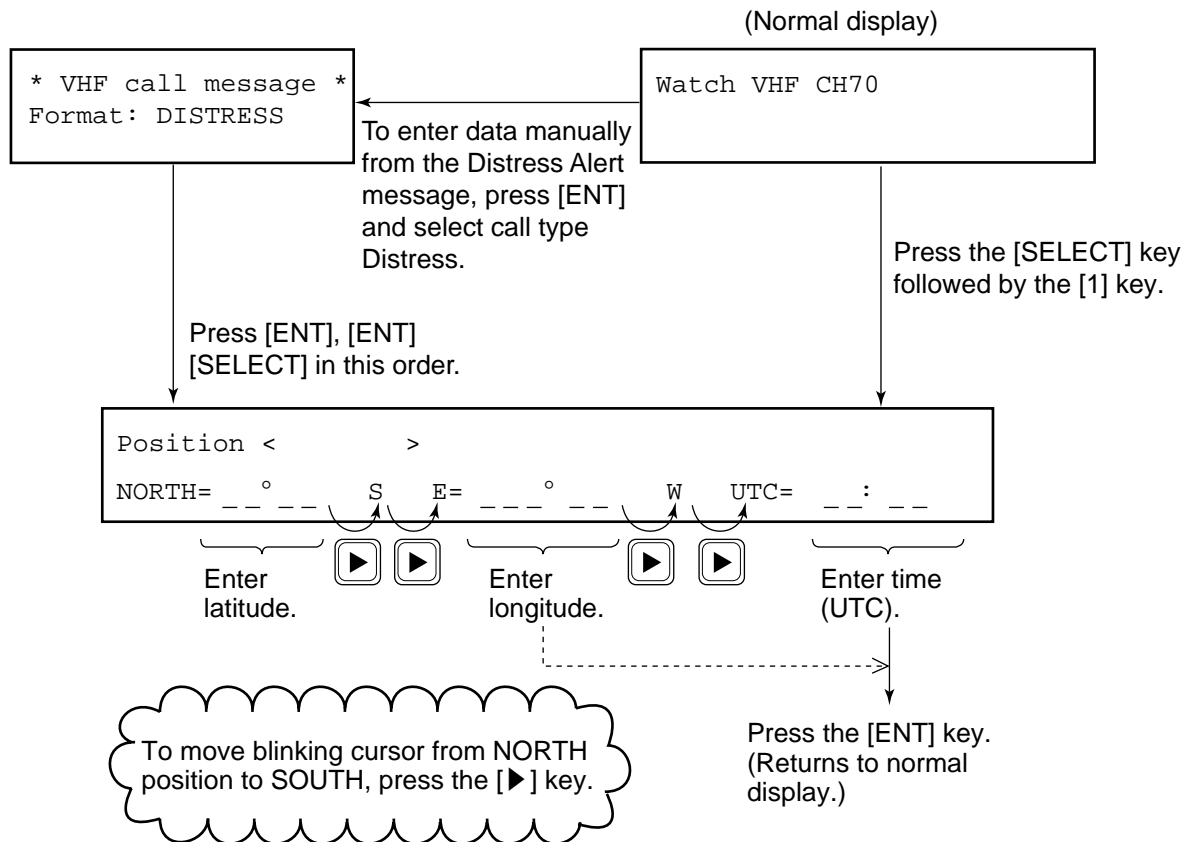

**Note:** If the manually entered position is not updated within four hours the buzzer sounds and the message "Warning: Update position!" appears on the screen. And if not updated within 23.5 hours the position entered is erased. Once automatic input of position is restored, cancel manually entered position as below.

### Confirming Ship's Position and Time

Press and hold down the [1] (POSITION) key, ship's position and time are shown while the key is pressed.

### Canceling manually entered data

To cancel the manually entered data, enter **9999** for the time and press the [ENT] key.

**Note:** Above procedure may also be used when you do not know your ship's position. This data is input as NO INFORMATION in POS&TIME in the DISTRESS ALERT MESSAGE.

## 3.3 Canceling a Distress Call

### Within five seconds after pressing the [DISTRESS] key

If the [DISTRESS] key is pressed by mistake, press the [ALARM STOP] key immediately (within 5 seconds). The distress call will be canceled.

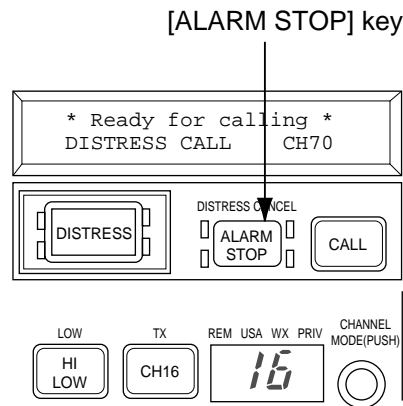

Figure 3-1 ALARM STOP key

### If more than five seconds elapses after the [DISTRESS] key is pressed

1. Switch off equipment immediately.
2. Switch equipment on and set to Channel 16.
3. Transmit message to "All Stations" giving your vessel's name, callsign and DSC number to cancel the distress alert.

#### Example message

All Stations, All Stations, All Stations  
This is VESSEL'S NAME, CALLSIGN,  
DSC NUMBER, POSITION.

Cancel my distress alert of  
DATE, TIME, UTC.  
=Master, VESSEL'S NAME, CALLSIGN.  
DSC NUMBER, DATE, TIME UTC.

## 3.4 Receiving Distress Alert from Other Vessel, Transmitting DIST ACK Signal

**In no case is a ship permitted to transmit a DSC distress relay call on receipt of a DSC distress alert on VHF channel 70.**

### Procedure when in area A1

1. When the FM-8700 receives a distress alert from another vessel the upper two LEDs (Red) near the [ALARM STOP] key blink and the FM-85700 sounds the distress alarm.
2. Silence the alarm by pressing the [ALARM STOP] key.
3. Wait up to three minutes until the DIST ACK signal from a coast station is received. Be prepared to follow the instructions of the coast station.
4. If you do not receive the DIST ACK signal, follow the flow chart shown on the next page.

If further DSC alerts are received from the same source and the ship in distress is beyond doubt in the vicinity, a DSC acknowledgement may, after consultation with an RCC or Coast Station, be sent to terminate the call.

**Note 1:** An asterisk (\*) in a received distress alert message indicates error or unknown at the location marked with the asterisk.

**Note 2:** Do not send DISK ACK in response to receipt of distress alert having a nature of distress of EPIRB emission.

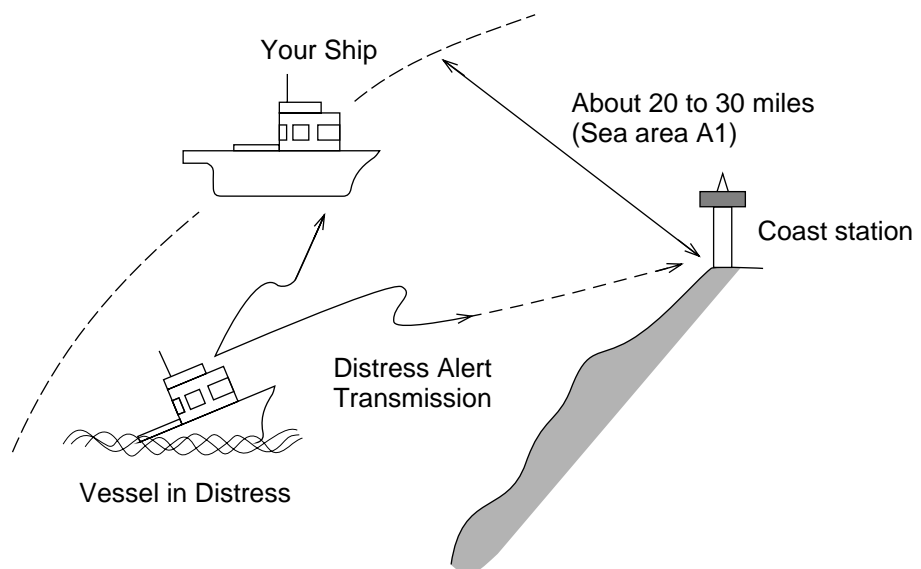

*Figure 3-2 Receiving distress alert from other vessel*

## Flow chart for determining if you should/should not transmit DIST ACK signal

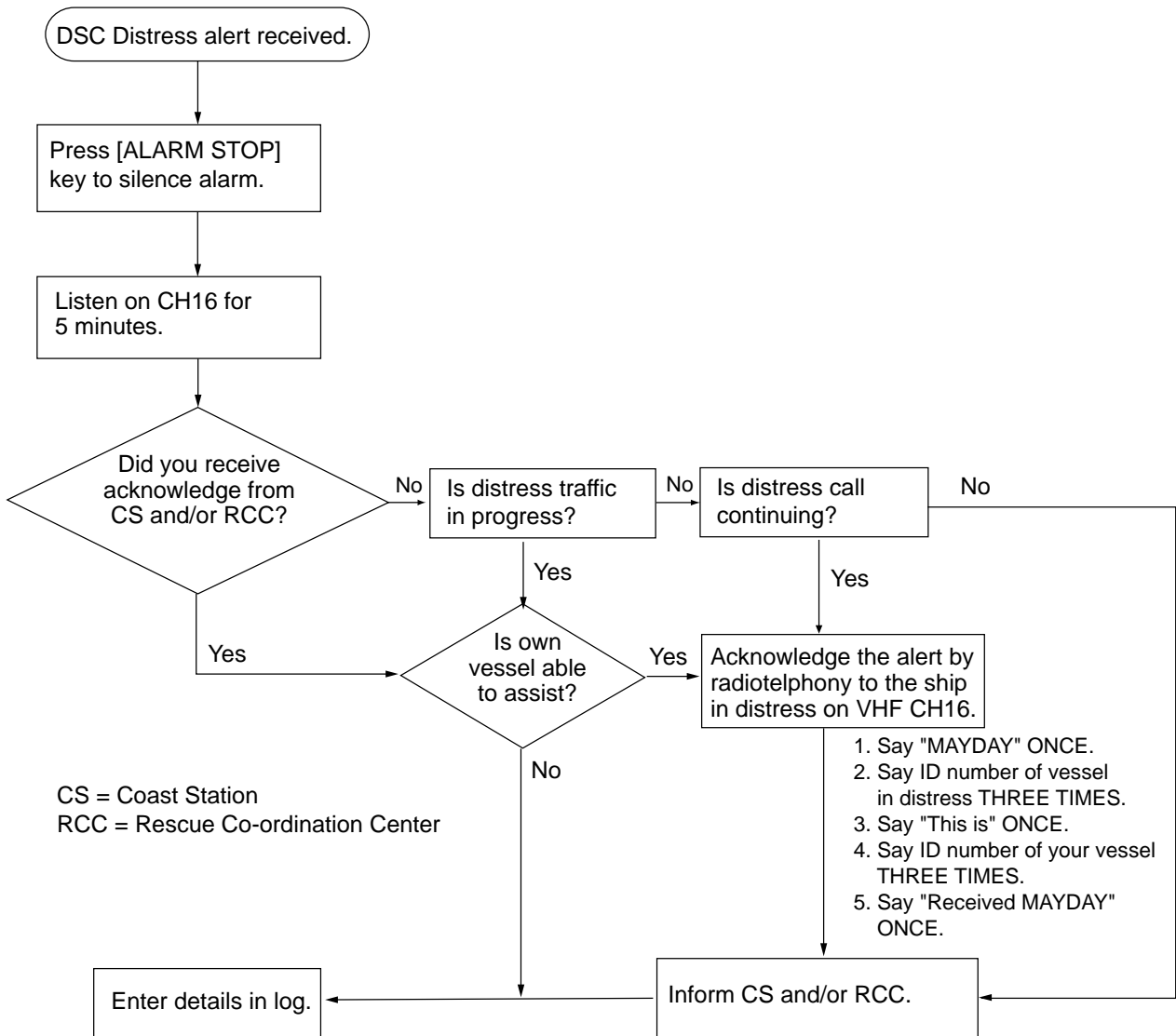

## Transmitting DIST ACK over CH16

Select VHF CH16 and transmit DIST ACK to vessel in distress.

No reply

Reply received

Transmit DIST ACK to vessel in distress over DSC CH70.

Communicate with vessel in distress.

Relay the distress alert to a coast station over DSC.  
Follow the instructions of the coast station.

Begin search and rescue operation for the vessel in distress.

## Transmitting DIST ACK signal

To transmit the DIST ACK signal, do the following:

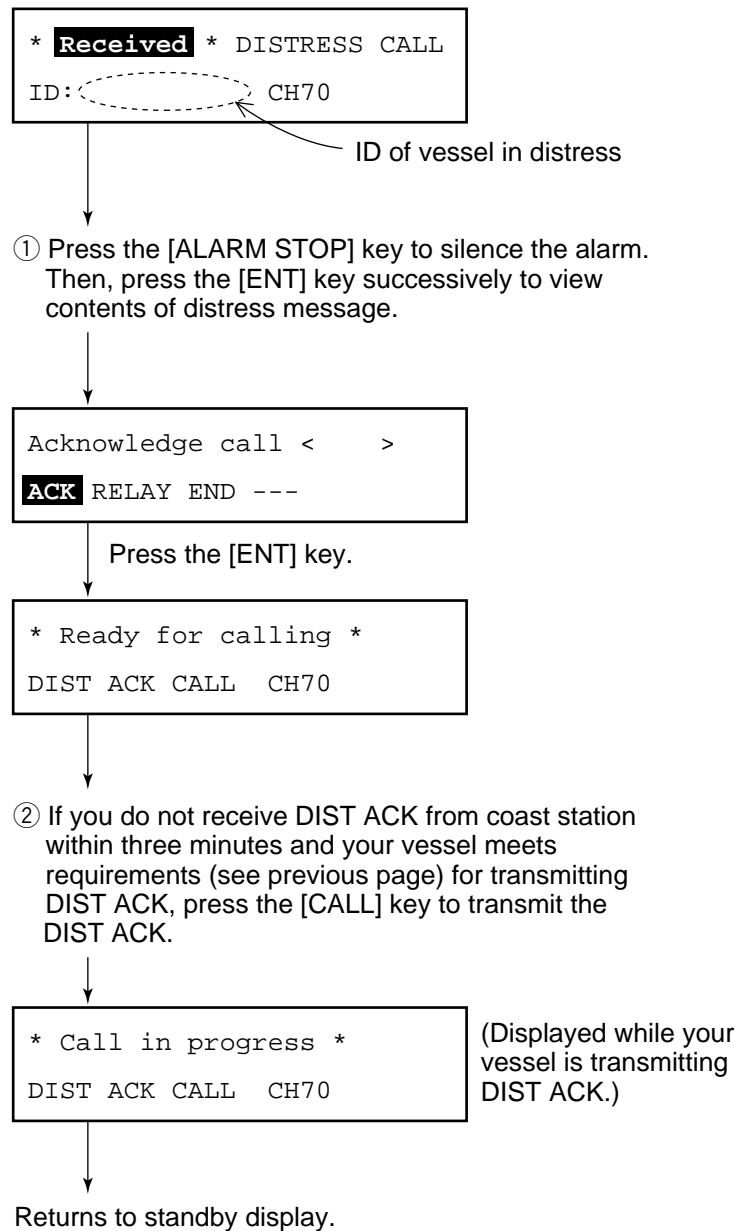

## After transmitting DIST ACK

Begin search and rescue operations for the vessel in distress, communicating with the vessel over CH16 (automatically set) on the FM-8700. Relay distress alert to coast station by MF DSC. Finally, follow instruction of the coast station.



## 3.5 Distress Alert Relay

### When you should relay a distress alert

You may relay a distress alert in the following conditions;

- ① When the station in distress is not itself in a position to transmit the distress message, or
- ② When the master or person responsible for the vessel not in distress, or the person responsible for the coast station, considers that further help is necessary.

*DO NOT press the [DISTRESS] key to relay a distress alert; it is for use when own vessel is in distress.*

### Relaying a distress alert

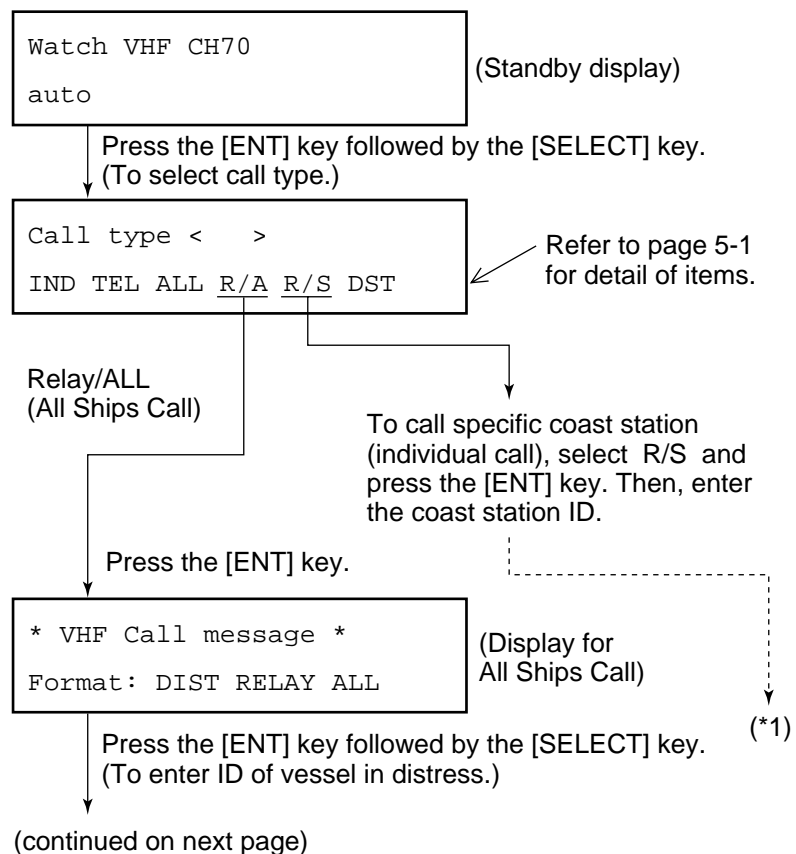

(from previous page)

Address < No inform >  
input digits=

(\*1)

Enter ID of vessel in distress.  
(If not know, enter all "9s" to set up for No information.)

Press the [ENT] key.

Nature of distress?  
UNDESIGNATED DISTRESS

To designate nature of distress,  
press the [SELECT] key.

If nature of distress is unknown, press the [ENT] key  
followed by the [SELECT] key.  
(To enter position of vessel in distress.)

Position < >  
NORTH=

Manually enter position of vessel in distress, referring to page 3-4. If position is unknown enter "9999" (no information).

Press the [ENT] key followed by the [SELECT] key.  
(To enter time.)

Distress UTC:  
UTC?

Manually enter time of distress.

Press the [ENT] key twice.

\* Ready for calling \*  
DIST RELAY ALL CH70

Press the [CALL] key.

(continued on next page)

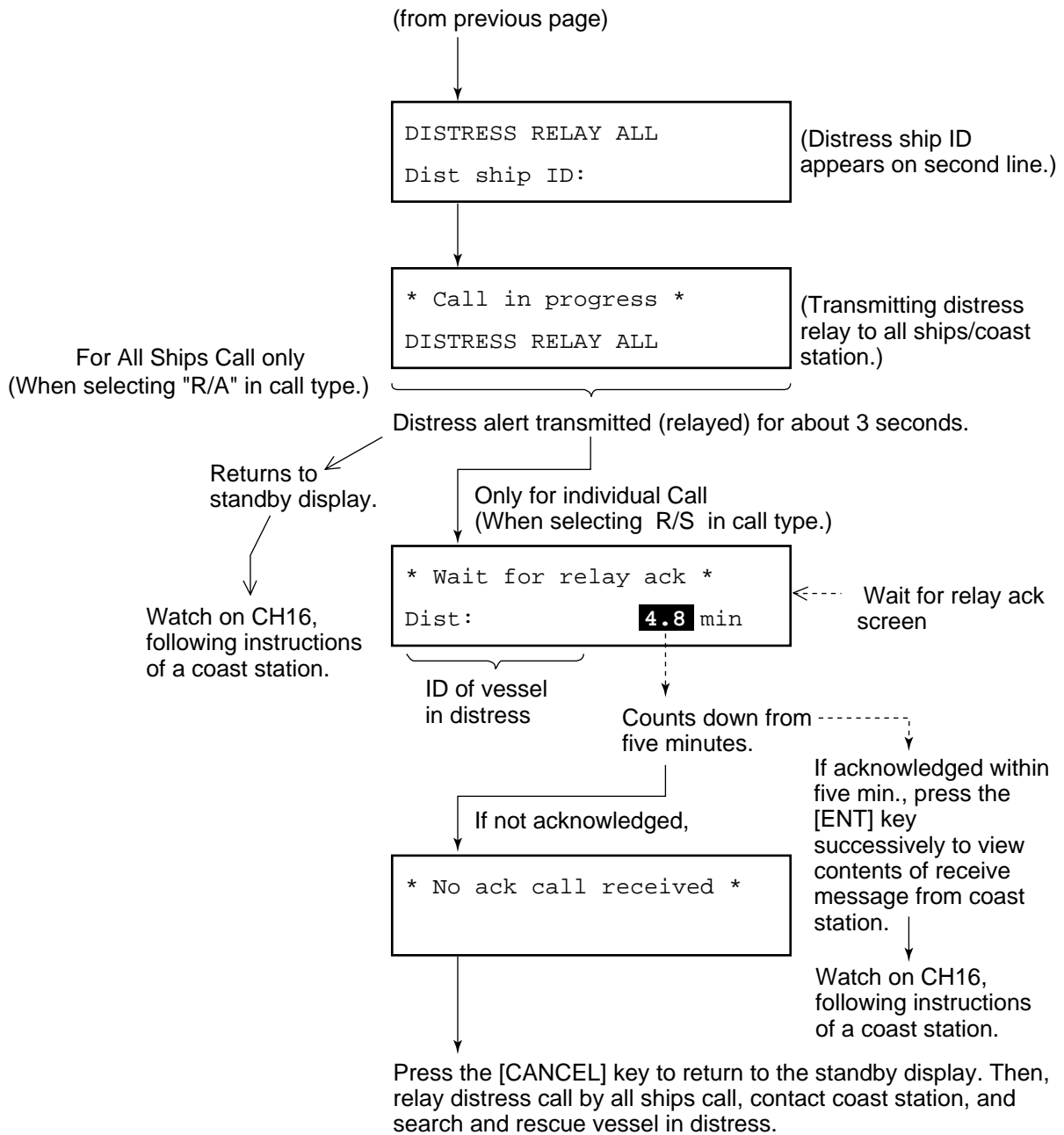

After relaying the alert, you must conduct search and rescue for the vessel in distress, following instructions of coast station.

This page is intentionally left blank.

# 4. DSC OPERATION FOR NON-DISTRESS CASES

## 4.1 Transmitting Individual Calls

The individual call is for sending message to a specific station. After transmitting message (called ACK RQ transmission), wait to receive the acknowledge back (ACK BQ) signal from receiving station. You should receive it within five minutes.

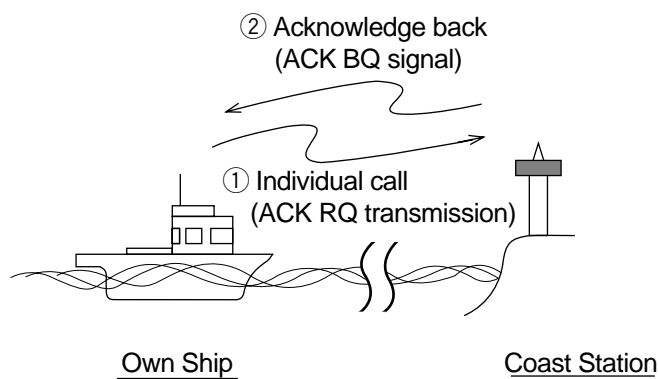
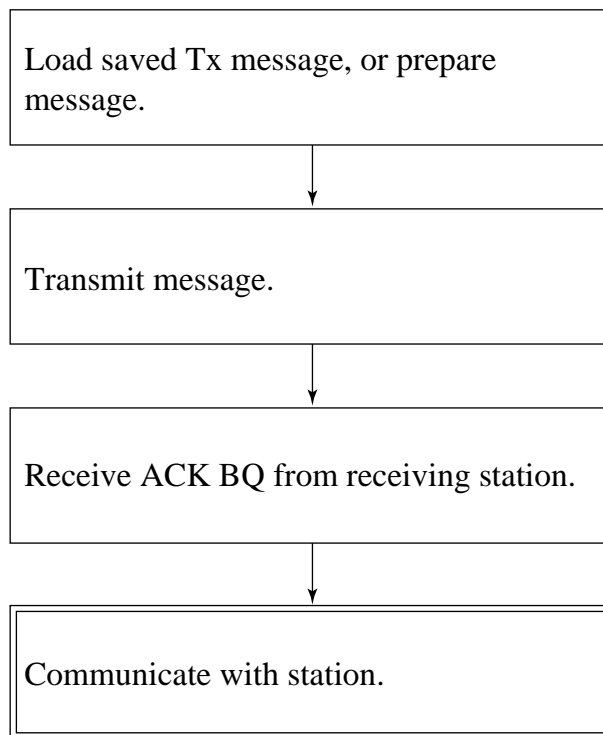

Figure 4-1 How an individual call is transmitted

### General procedure for transmitting an individual call



## Detailed procedure for transmitting an individual call

Prepare and transmit a message as follows:

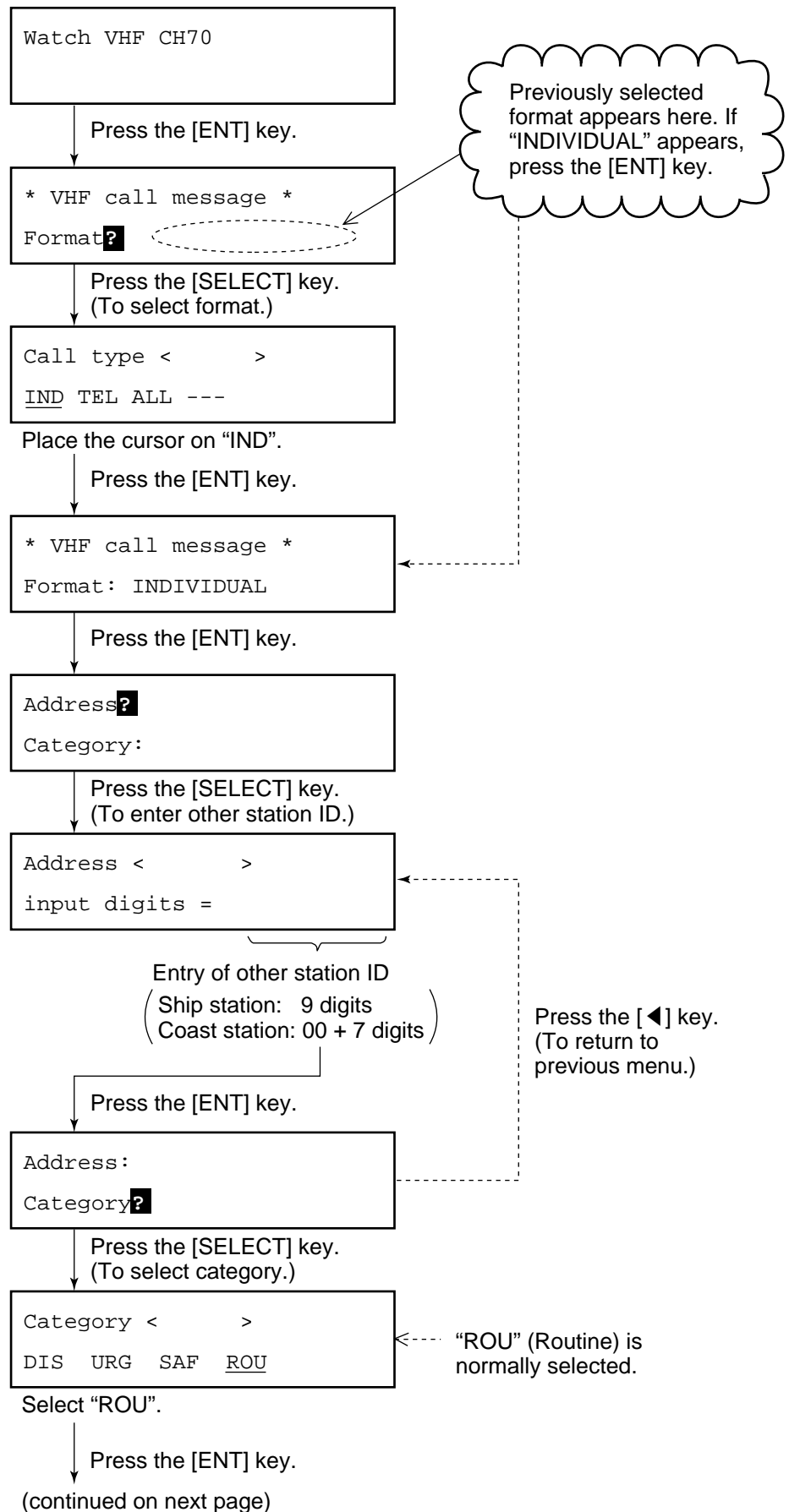

(from previous page)

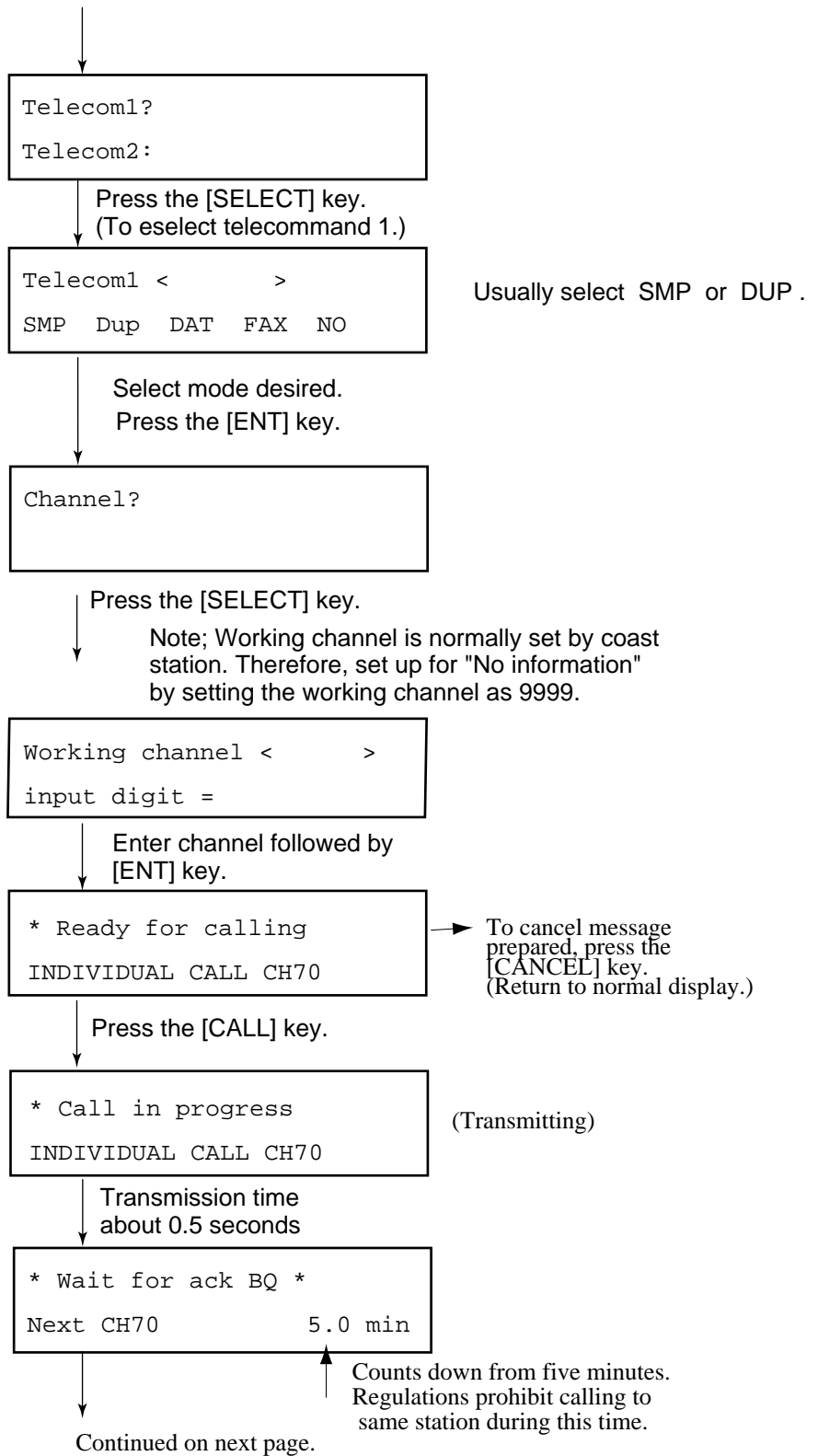

(From previous page)

After receiving the ACK BQ signal, do the following:

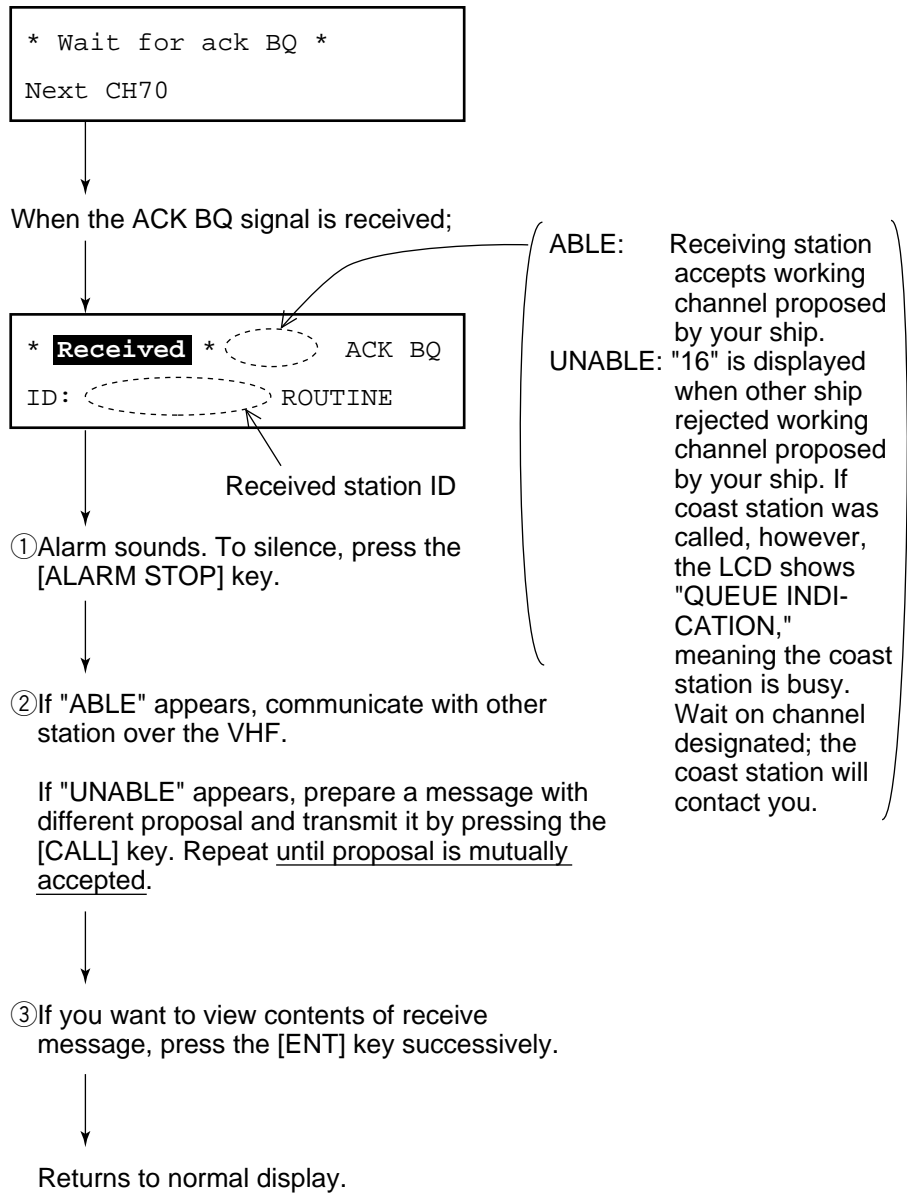



## 4.2 Receiving Individual Calls (ACK RQ)

When an individual call is received, the FM-8700 responds to the call depending on the setting of automatic acknowledge (AUTO ACK) function:

- AUTO ACK “ON” (“Auto” appears.)

The DSC transmits the acknowledge back (ACK BQ) signal automatically.

- AUTO ACK “OFF” (“Manual” appears.)

Verify contents of receive message by pressing the [ENT] key successively, then manually transmit the ACK BQ signal by pressing the [CALL] key.

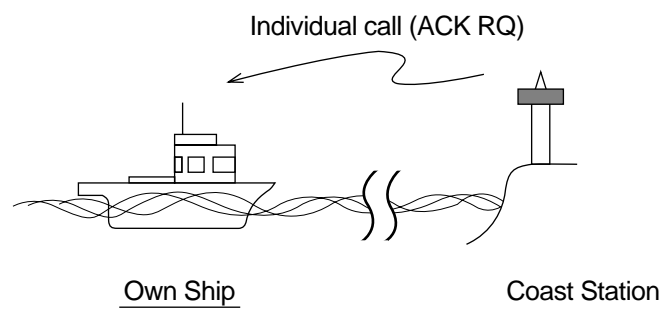

*Figure 4-2 How to receive an individual call*

### Setting of “ABLE” or “UNABLE”

When AUTO ACK function is ON, you can select either “able” or “unable” (to comply) for proposal from other station. See the next page.

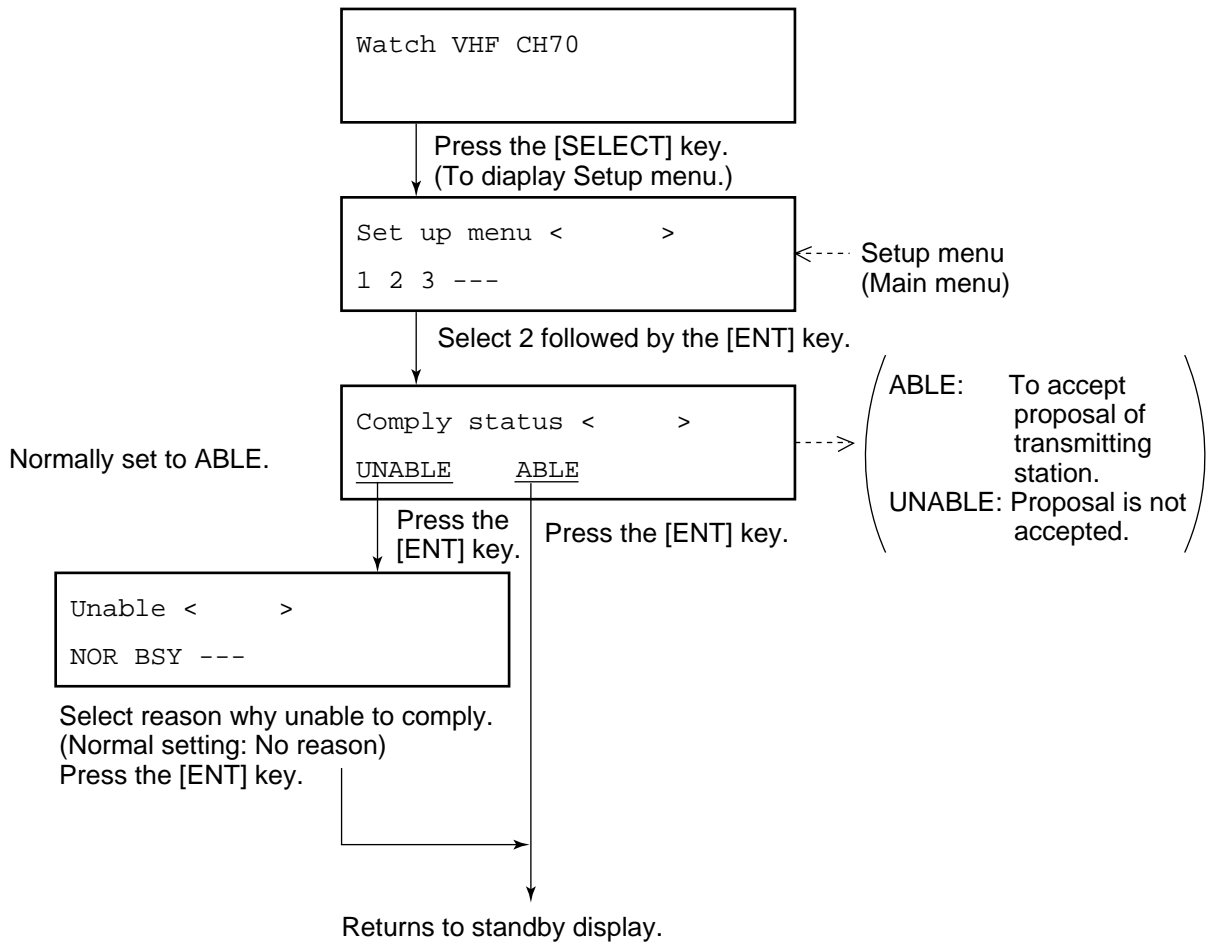

## Receiving individual call with AUTO ACK ON

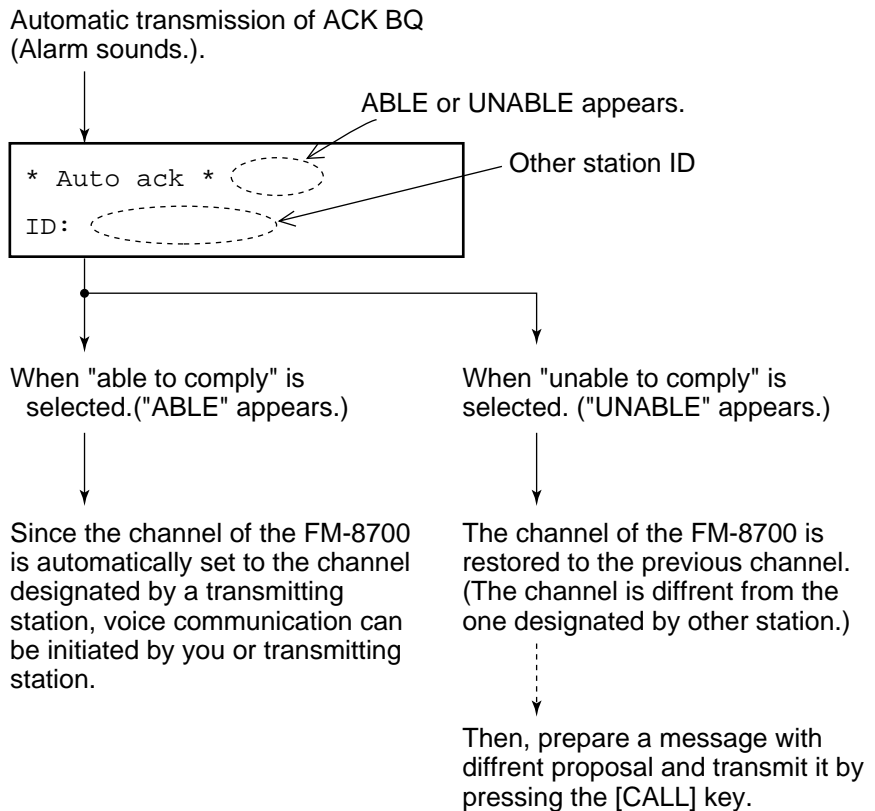

## Receiving ACK RQ with AUTO ACK OFF

After verifying contents of receive message, manually transmit the ACK BQ signal by pressing the [CALL] key within five minutes. If the signal is transmitted more than five minutes after reception of ACK RQ signal, it is treated as an ACK RQ signal rather than an ACK BQ signal.

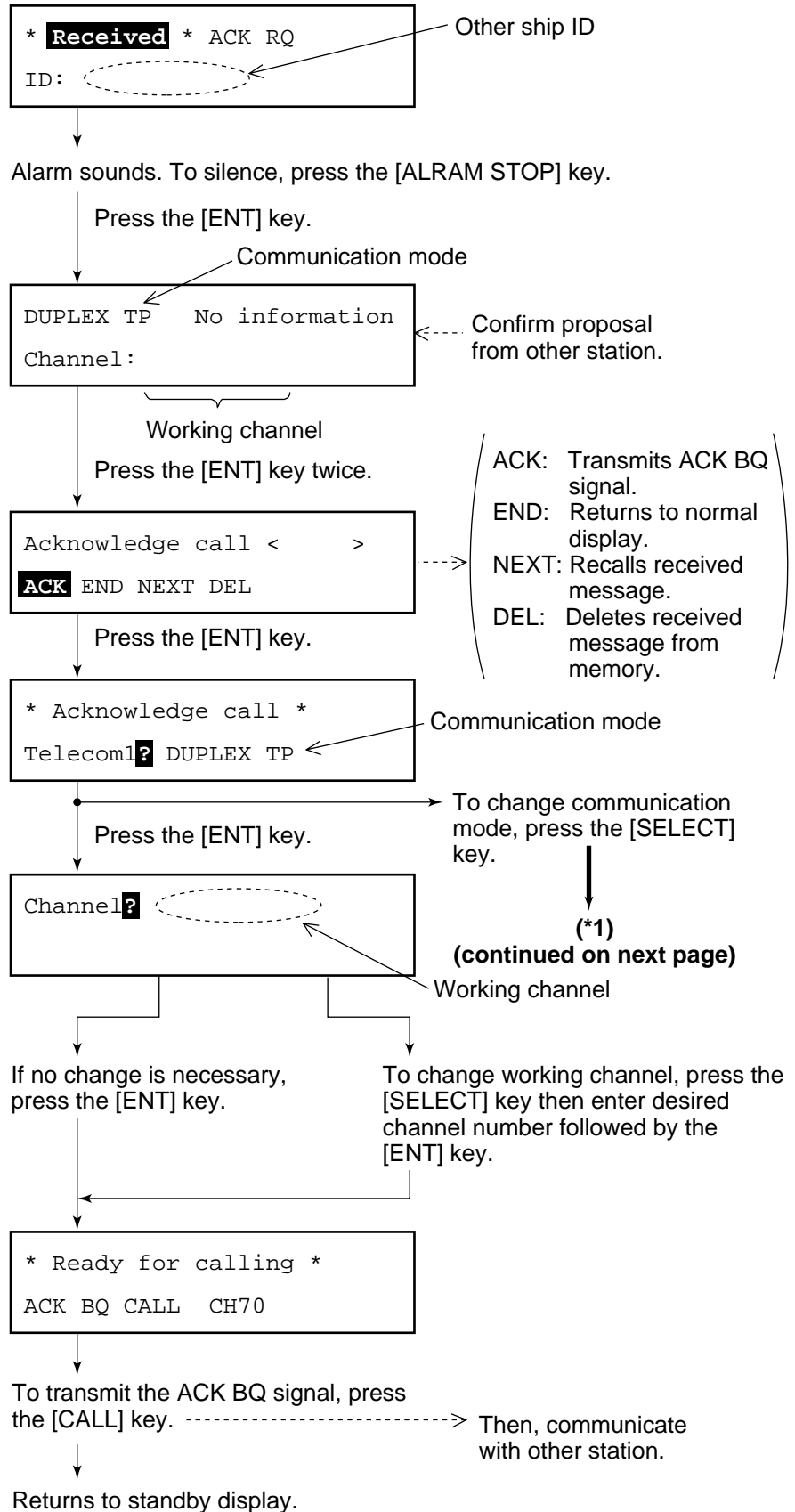

(\*1)  
(from previous page)

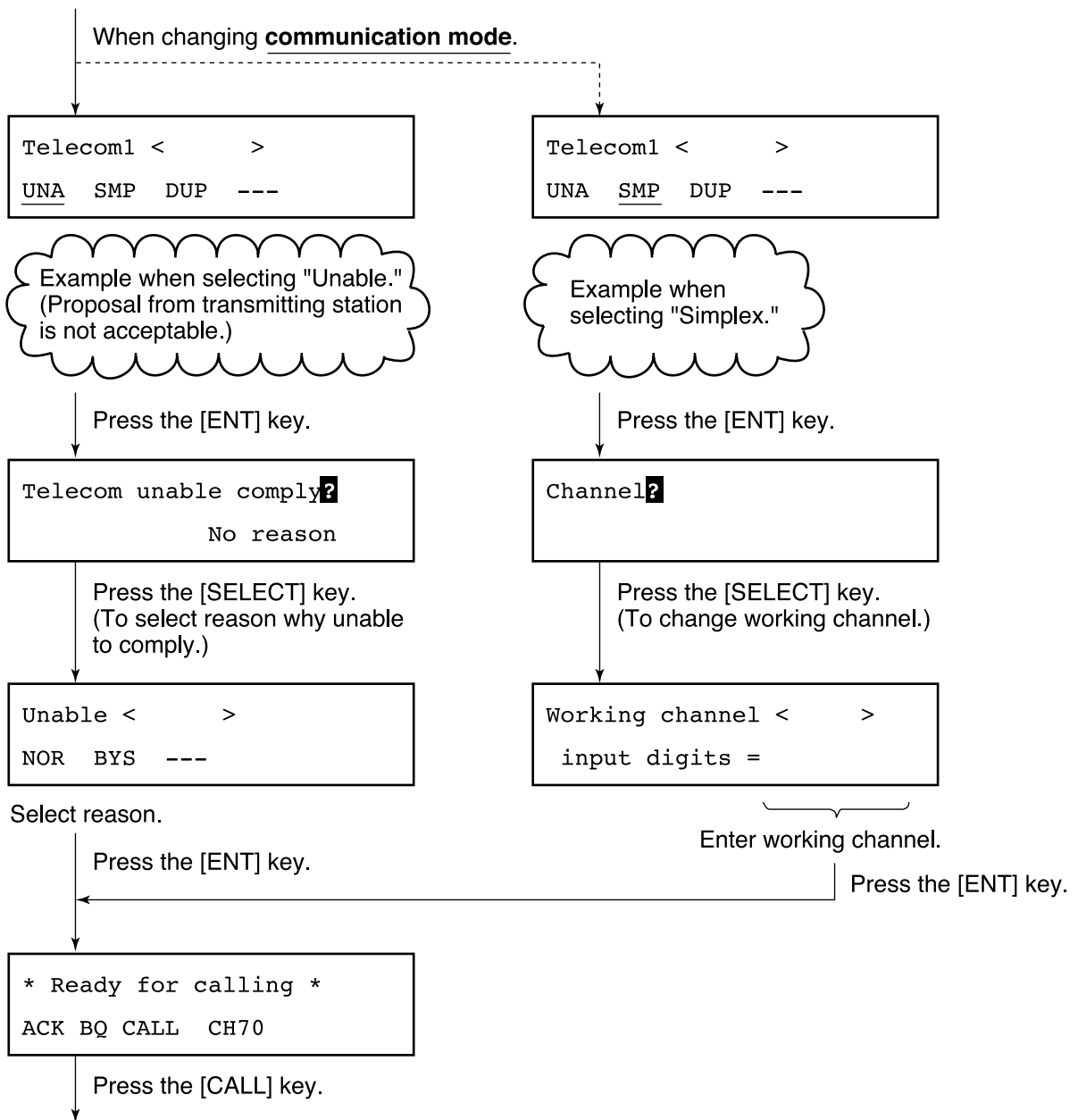

If a different communication mode is selected as shown above, "ACK BQ" call is first transmitted and "ACK RQ" call automatically continues. This means the message proposed here is transmitted as ACK RQ signal (not ACK BQ). Finally the "Wait for ACK BQ" screen appears.

## 4.3 Transmitting All Ships Calls

### Purpose of all ships call

The All Ships Call is used to transmit important ship's safety message, safety of life at sea message or meteorological warning.

After transmitting message, you can communicate by voice over the FM-8700.

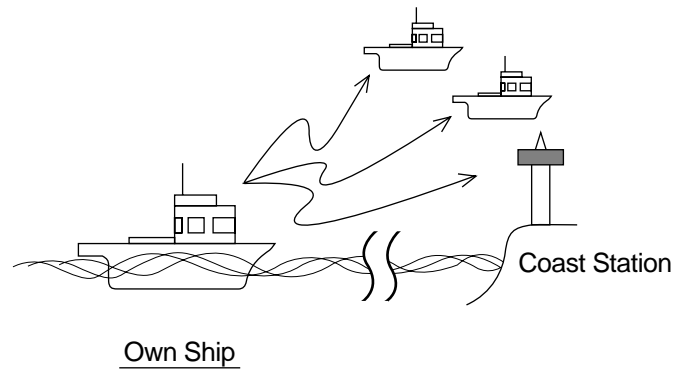

*Figure 4-3 All ships call*

### General procedure for transmitting an all ships call

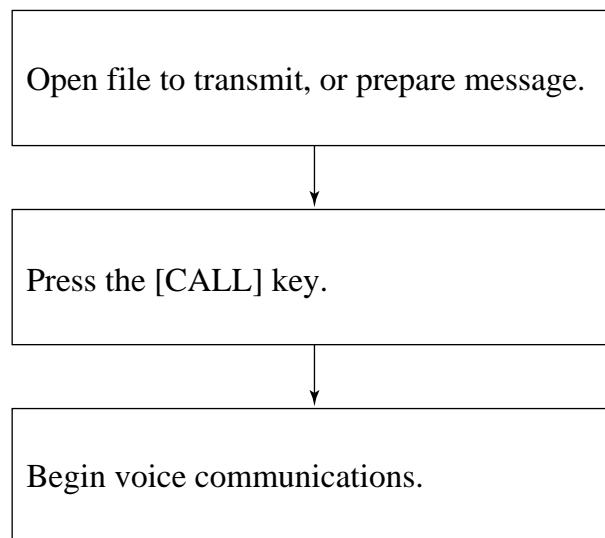

The procedure for voice communication is shown on the next page.

## Detailed procedure for transmitting an all ships call

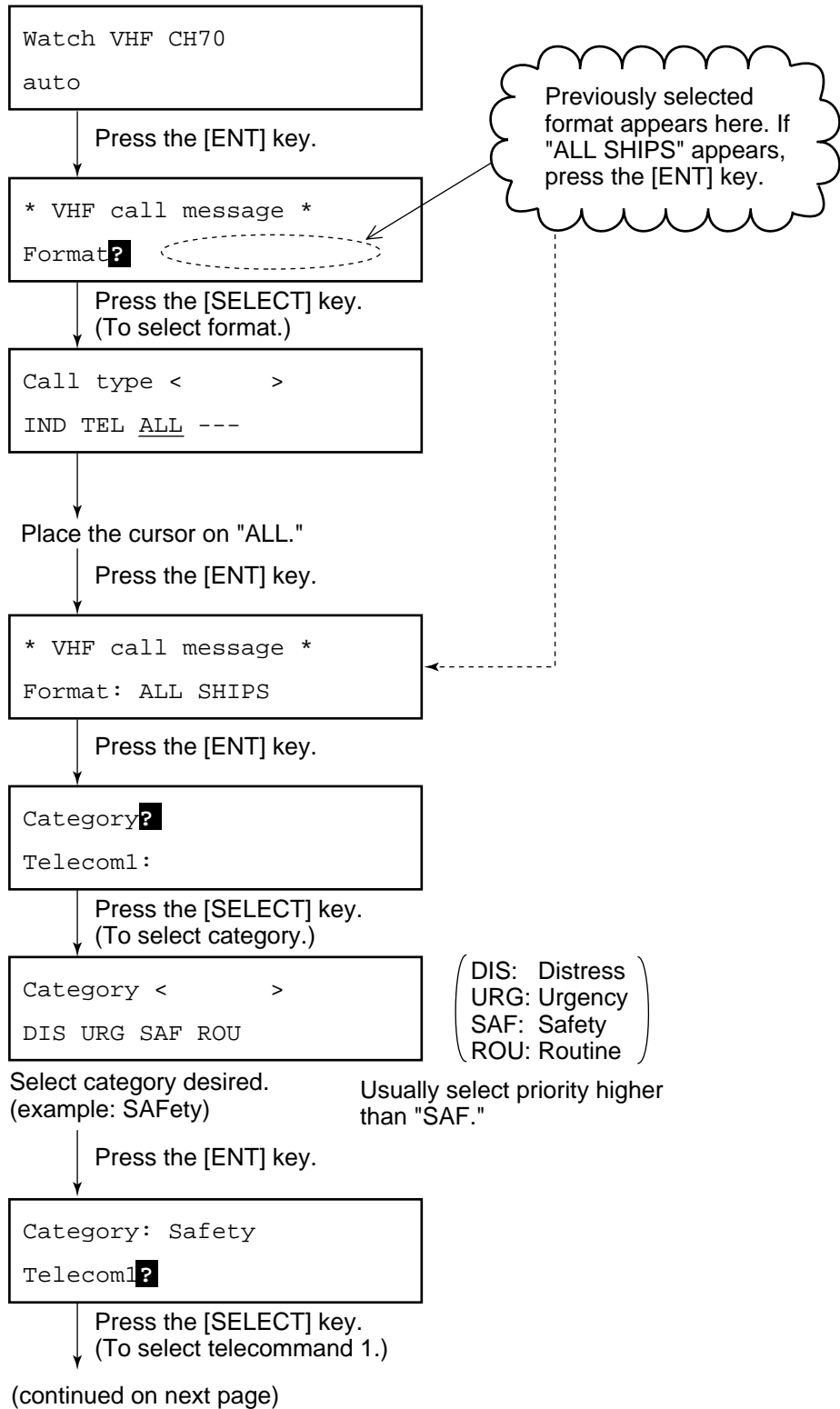

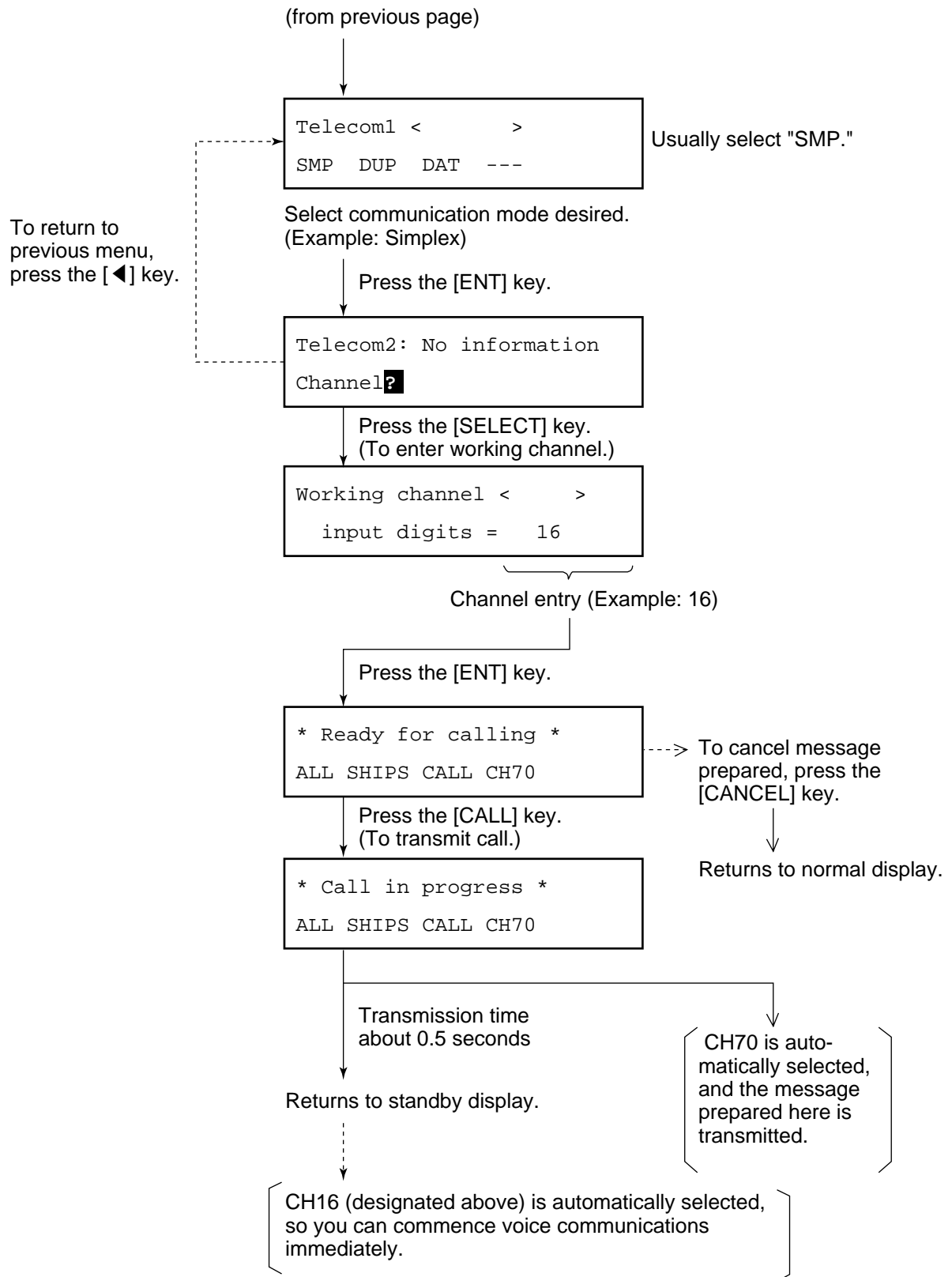

## 4.4 Receiving All Ships Calls

When an all ship's call is received while conducting voice communications, press [2] (AUTO ACK) to switch to VHF channel. The all ship's call, transmitted by coast station or ship station, provides navigation and weather alerts and emergency information.

### Status of FM-8700 when receiving an all ships call

Handset status	When an all ship's call is received
On hook (*)	<ol style="list-style-type: none"><li>1. Equipment automatically switches to working channel.</li><li>2. Caller's voice can be heard.</li></ol>
Off hook (*)	<ol style="list-style-type: none"><li>1. Alarm sounds.</li><li>2. Press [2 ](AUTO ACK) key to switch to working channel.</li><li>3. Caller's voice can be heard.</li></ol>

\* On hook: Handset hung in hook.  
Off hook: Handset picked up.

### Receiving an all ships call in on hook status

#### Basic procedure for receiving an all ships call while on hook

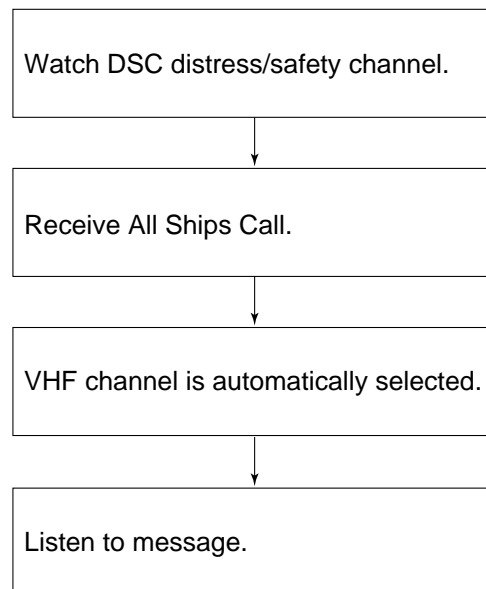



## Detailed procedure for receiving an all ships call while on hook

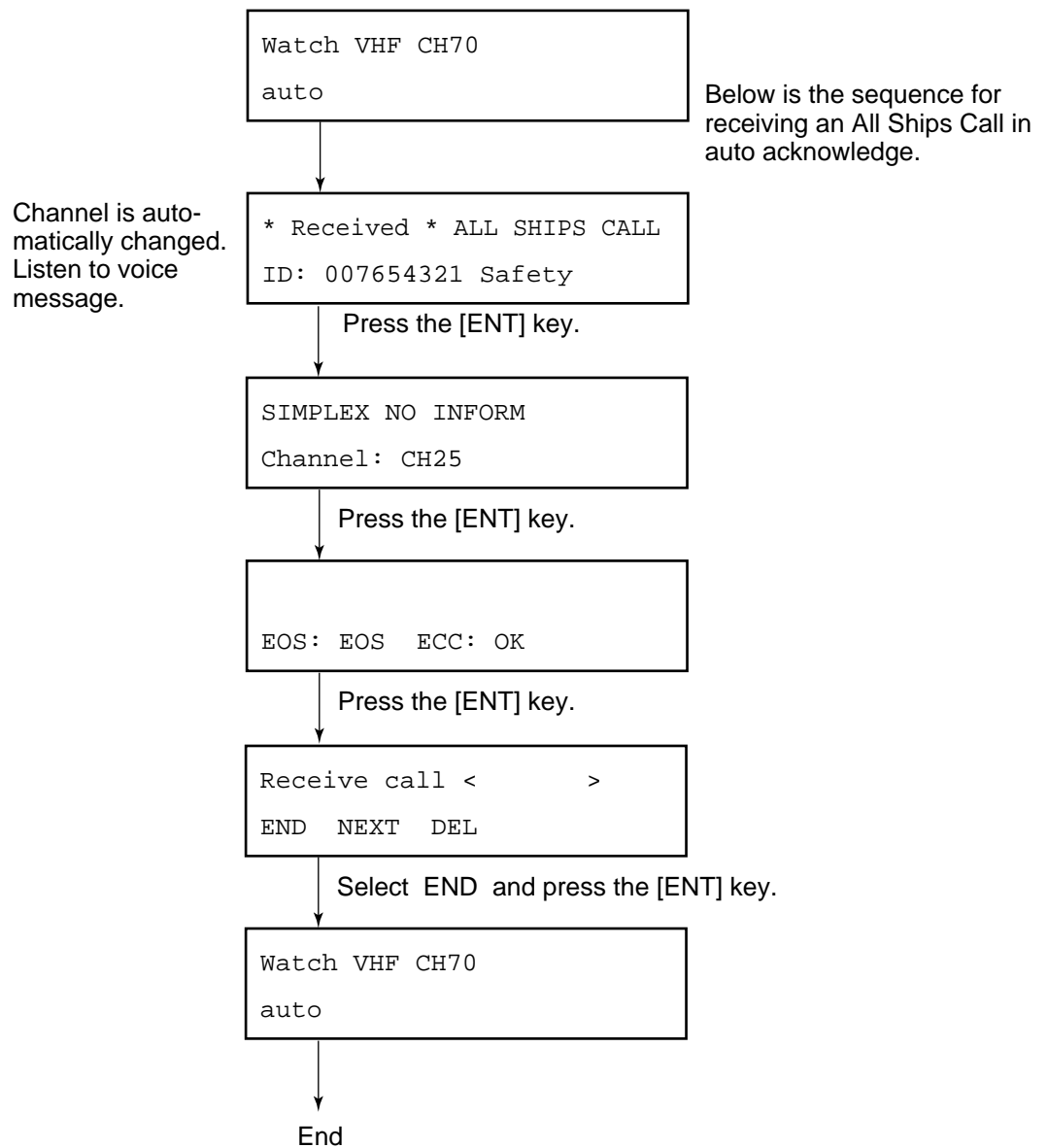

## Receiving an all ships call in off hook status

### Basic procedure for receiving an all ships call while off hook

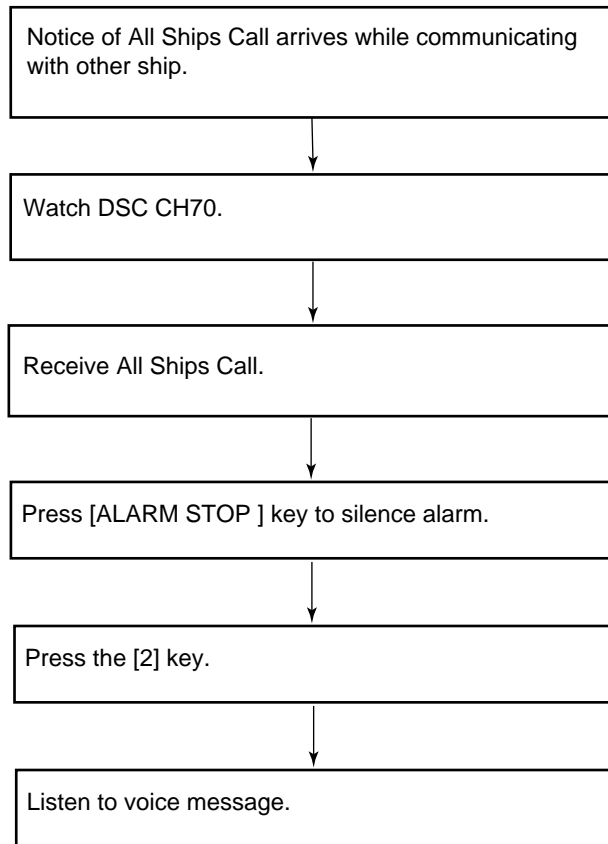

## Detailed procedure for receiving an all ships call while off hook

Below is the sequence for manually acknowledging an all ships call when the handset is off hook.

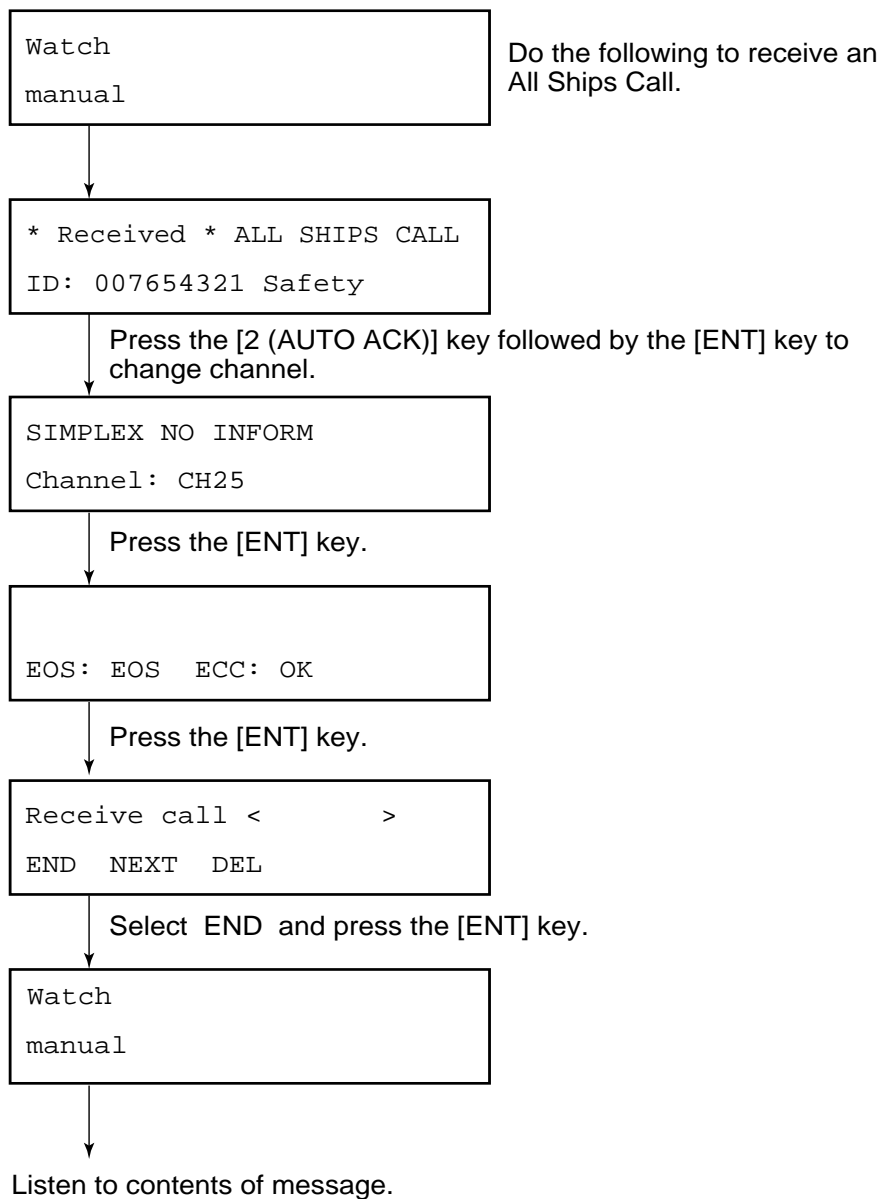

## 4.5 Preparing and Saving Messages

There are two ways to prepare and transmit a message:

1. Prepare a message for immediate transmission. (Refer to page 4-1.)
2. Prepare a message and store it for later transmission.

You can save up to 59 transmit messages (excluding distress messages) to the memory. These are numbered 01 to 59.

### How to prepare transmit messages

Prepare message as follows:

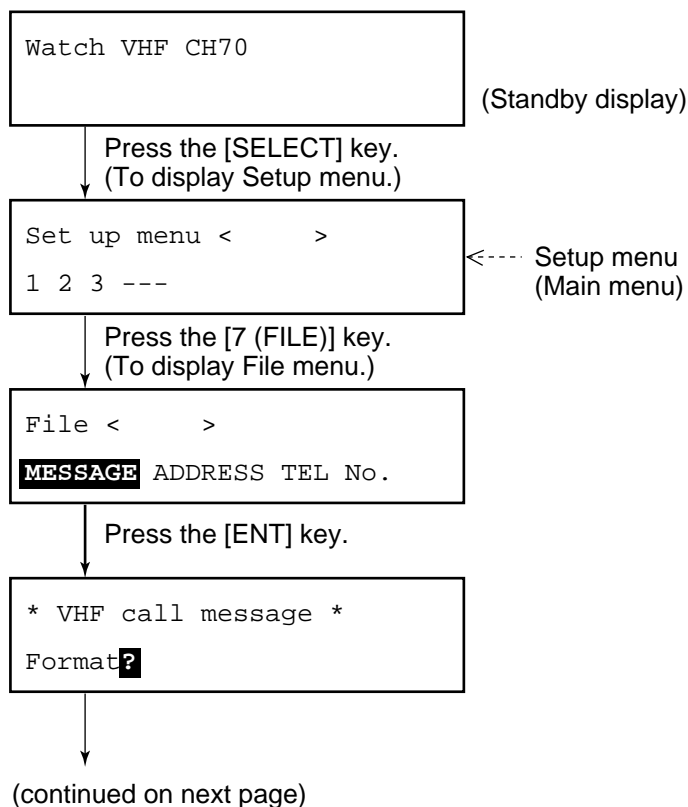

(from previous page)

Prepare an Individual message (page 4-1) or All Ships message (page 4-9).

\* Ready for filing \*

Press the [ENT] key.  
(To select file number under which to save message.)

Call message < >  
01/59:

File No.  
(blinking)

To select a different file number, use the arrow keys.  
(▶:Up, ◀:Down)

Press the [ENT] key.  
(To assign file name.)

Name < >  
END A B C D ----- R →

To scroll screen, press the [▶] key.

Assign a file name (max. 16 characters) by the arrow keys, the [ENT] key and ten keys.

Example File Name: A1

1. Place the cursor on "A" with the arrow keys and press the [ENT] key.  
(For alphabet always press the [ENT] key after selection.)
2. Press the [1] key.

To change specific character, press the [SELECT] key and ...

▶ : Moves upper cursor rightward every pressing.  
◀ : Moves upper cursor leftward every pressing.

Name < A1 >  
END A B C D ---

To change entire name, press the [CANCEL] key.

Press the [◀] key to place the lower cursor on "END".

Press the [ENT] key.

Using the example above, the unit saves the transmit message to the memory under file number 1, file name "A1".

Next file memory < >  
END NEXT

To prepare another message;

Press the [ENT] key.

Press the [ENT] key.

Returns to standby display.

\* VHF call message M \*  
Format?

## 4.6 Writing Over Files

You may write over unnecessary files. Simply prepare a message and store it under file number of unnecessary file.

### How to write over files

Example: You want to write over file saved under file number 01.

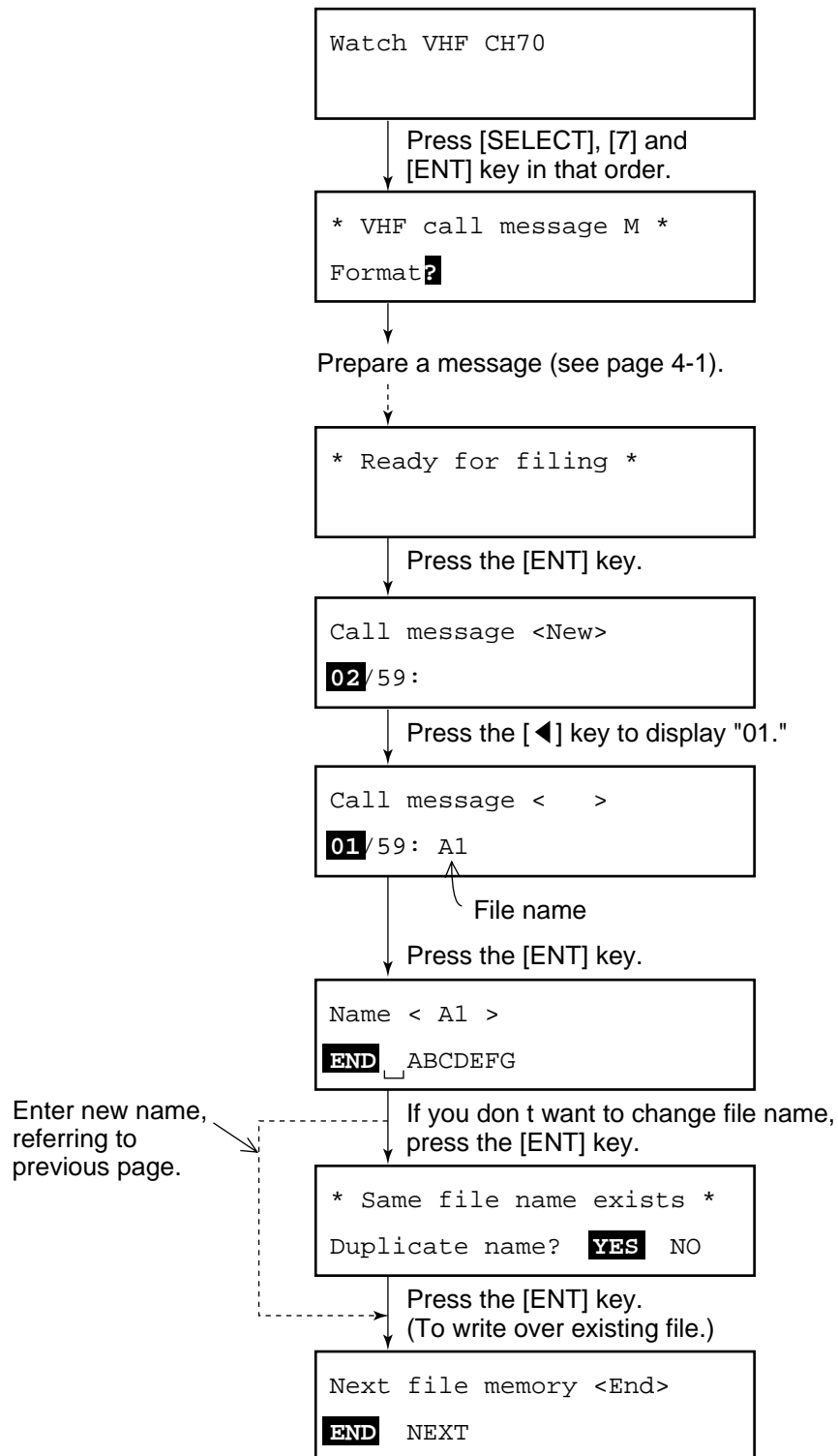

## 4.7 Opening, Transmitting Files

### Opening a file

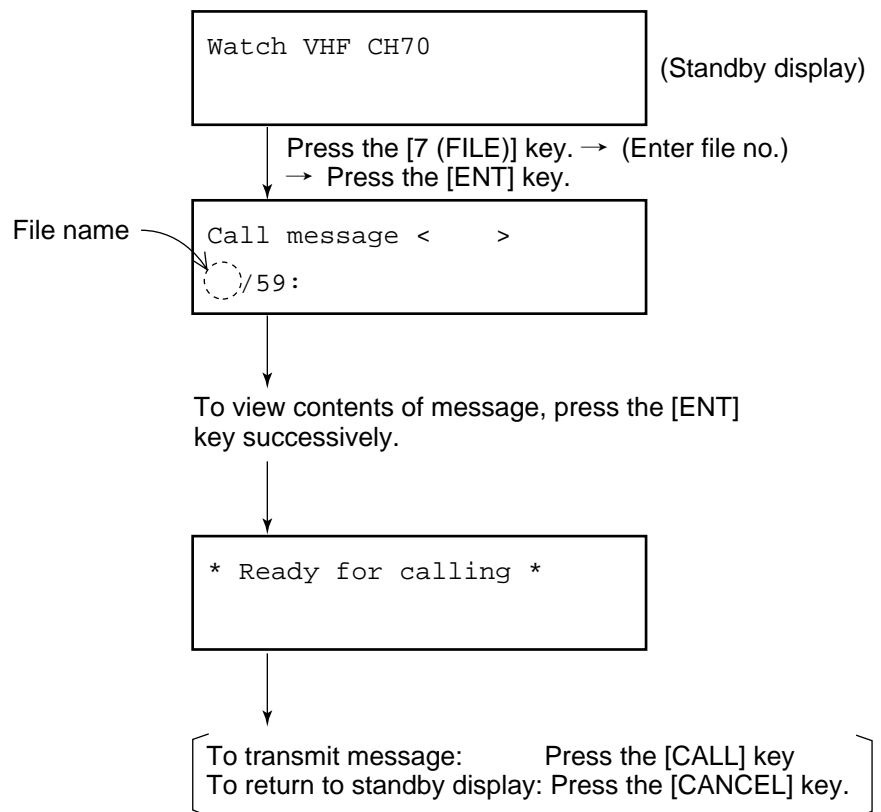

### Transmitting a file

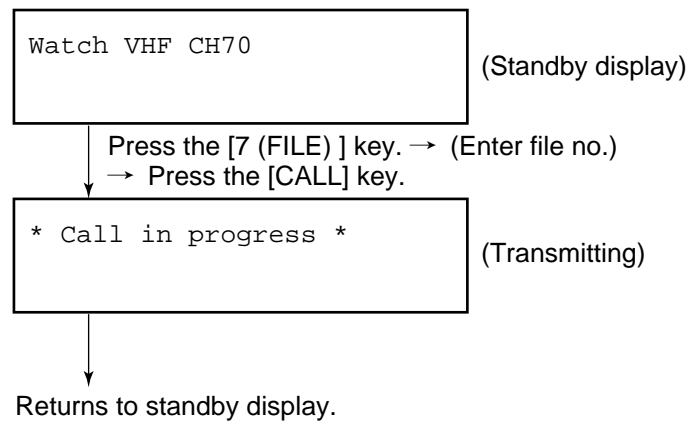

## 4.8 Transmit/Receive Message Memory

The transmit message memory stores up to 50 transmitted messages (numbered 1 to 50) on a first-in, first-out basis. This means each time you save a transmitted message it is filed as log no. 1 and the log no. of all previously stored transmit messages changes by one. When the memory is full the oldest file is deleted.

### Opening a transmit message

Press the [9 (XMTD)] key at the standby display.

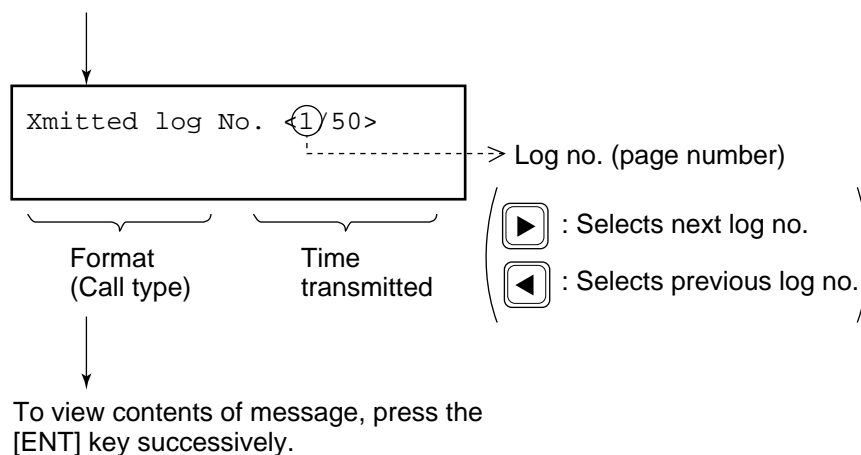



## Transmitting retrieved message

You can transmit a retrieved message as follows:

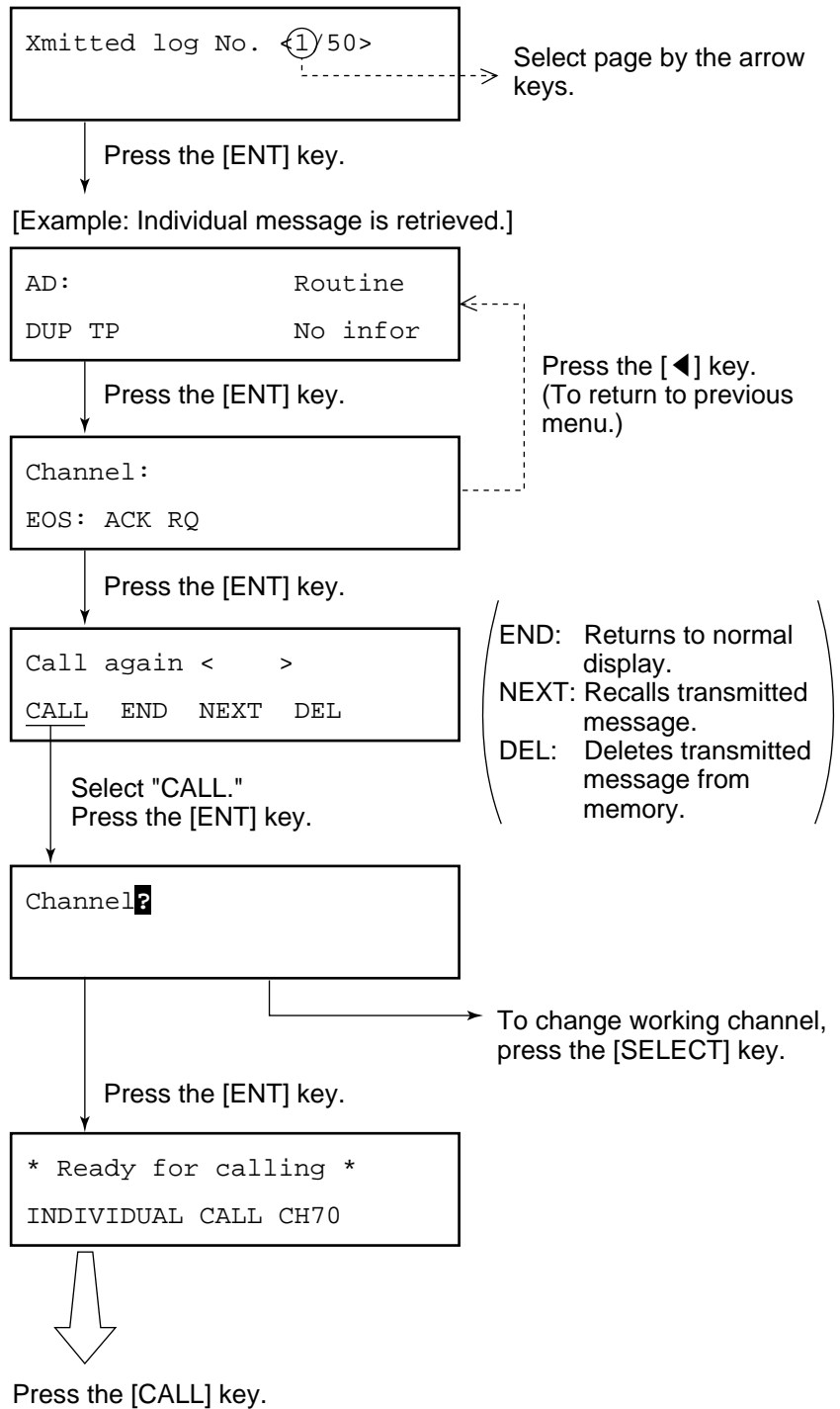

## Receive message memory

All received messages are automatically saved to the memory and filed according to category, DISTRESS or ORDINARY. The receive message memory can store up to 50 messages (numbered 1 to 50) of each category on a first-in, first-out basis. This means each time the unit receives a message it saves it as log no.1 and changes the log no. of all previously received messages by one. When the memory is full the oldest file is deleted.

## Opening a receive message

Press the [8 (RCVD)] key at the standby display.

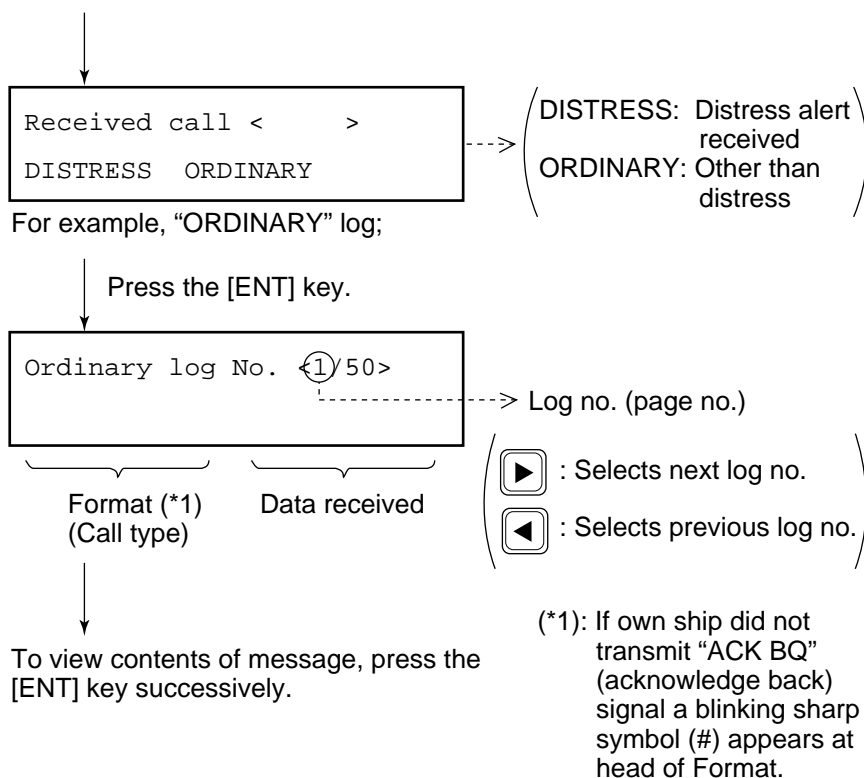

## Transmitting retrieved message

You can send the acknowledged call (DIST ACK or ACK BQ) under certain conditions after retrieving a received message. Refer to page 3-5 for transmitting the DIST ACK signal.

Example: Transmit acknowledge back (ACK BQ) signal in response to an individual call (Refer to page 4-5.)

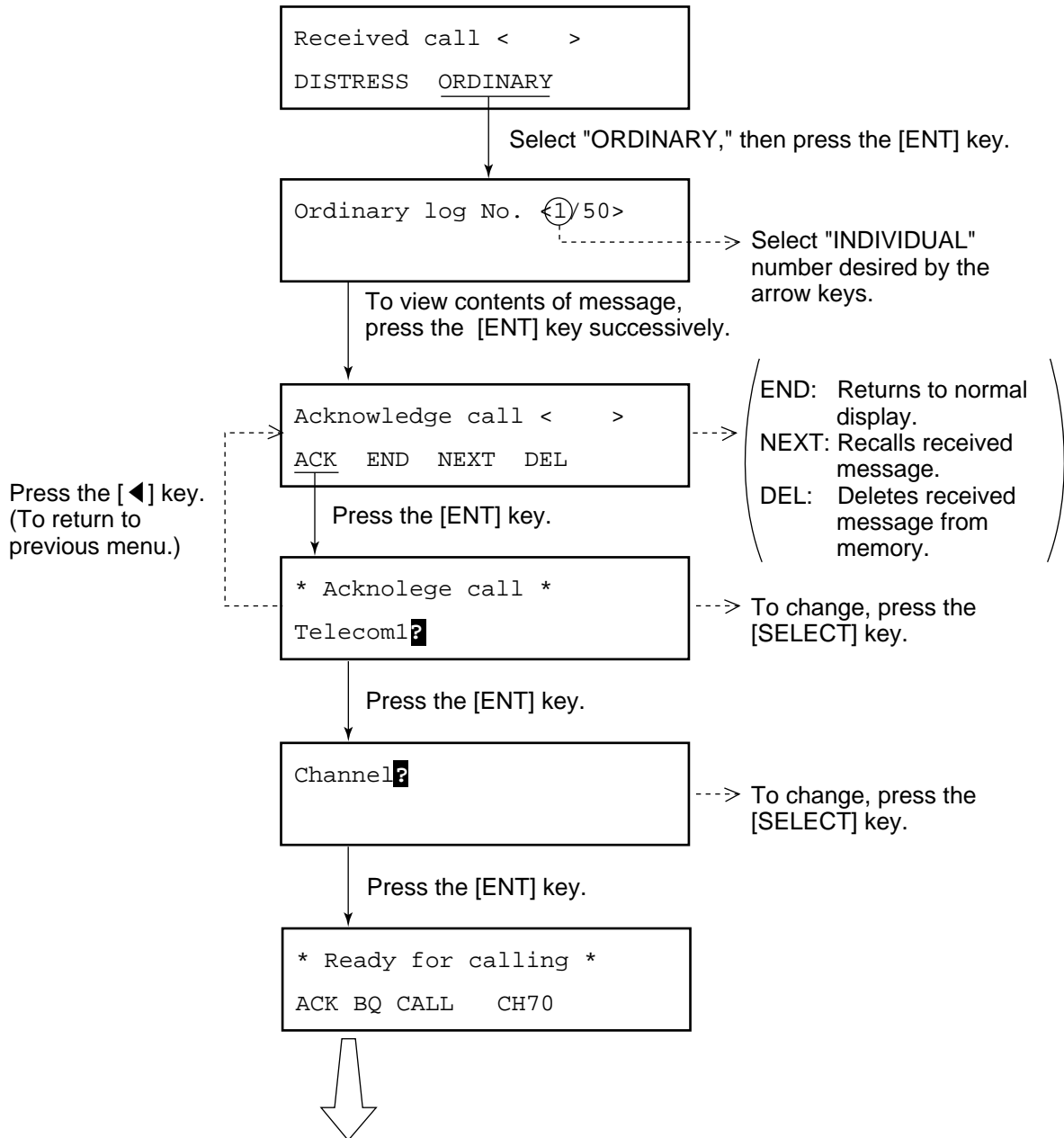

Press the [CALL] key to transmit the ACK BQ signal.

**Note:** If the ACL BQ signal is transmitted more than five minutes after reception of ACK RQ signal, it is treated as an ACK RQ signal rather than ACK BQ.

This page is intentionally left blank.

# 5. OTHER CALLING TYPES

## 5.1 Selection of Other Calling Types

The FM-8700 provides 12 calling types. Of these, individual, all ships and distress were discussed in previous chapters. This section describes the other types of calls available. The procedure for preparing and transmitting other calls is the same as that for individual and all ships calls: Select type of call, prepare message and transmit it by pressing the [CALL] key.

### How to select other calling types

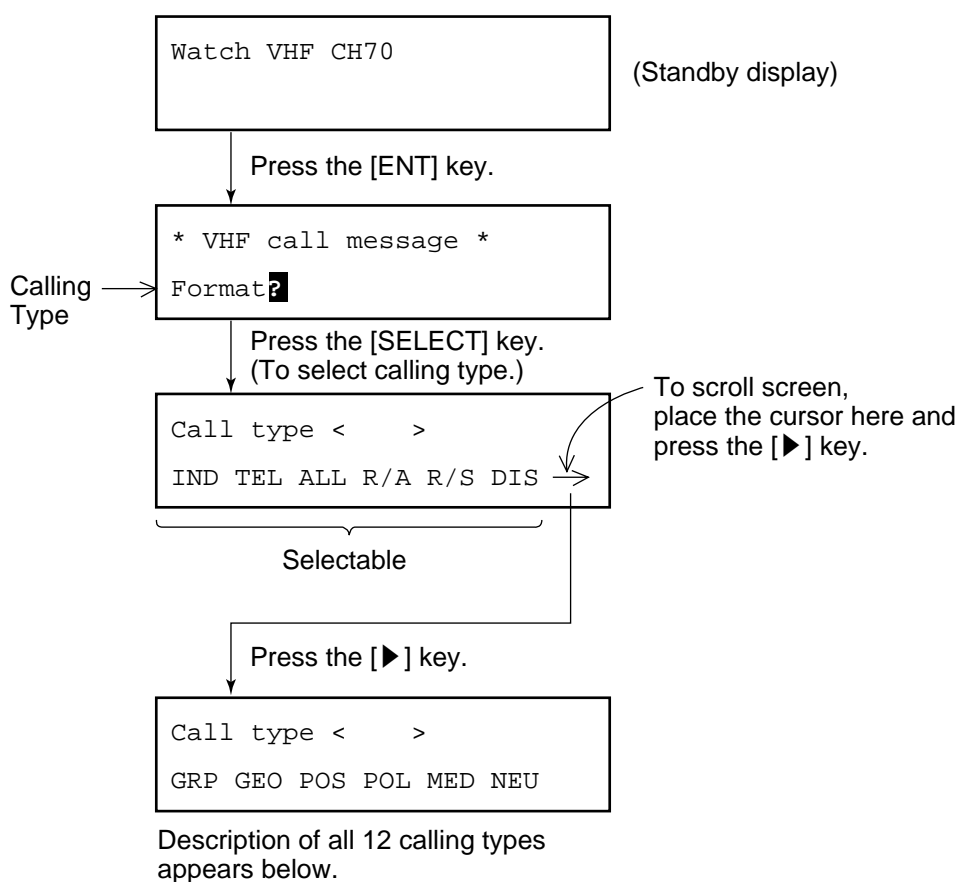

### Calling types description

- IND:** **Individual call.** (Refer to page 4-1.)
- TEL:** **Telephone call.** (Semi-auto/auto call. Refer to page 5-3.) Call a terrestrial network, for example, through a coast station.
- ALL:** **All Ships call.** (Refer to page 4-9.)

**R/A and R/S:** **Distress relay for All Ships and for Selective (Individual) calls.** (Refer to page 3-9.)

**DIS:** **Distress call.** (Refer to page 3-1.)

**GRP:** **Group call.** Call a specific group by entering group ID number.

**GEO:** **Geographic area call.** Call for ships within a range set by you in the transmit message (menu). To designate the range, enter reference point and width (range) data of both longitude and latitude.

Example: Ocean AD ... 34N 135E da10 do5

Range data

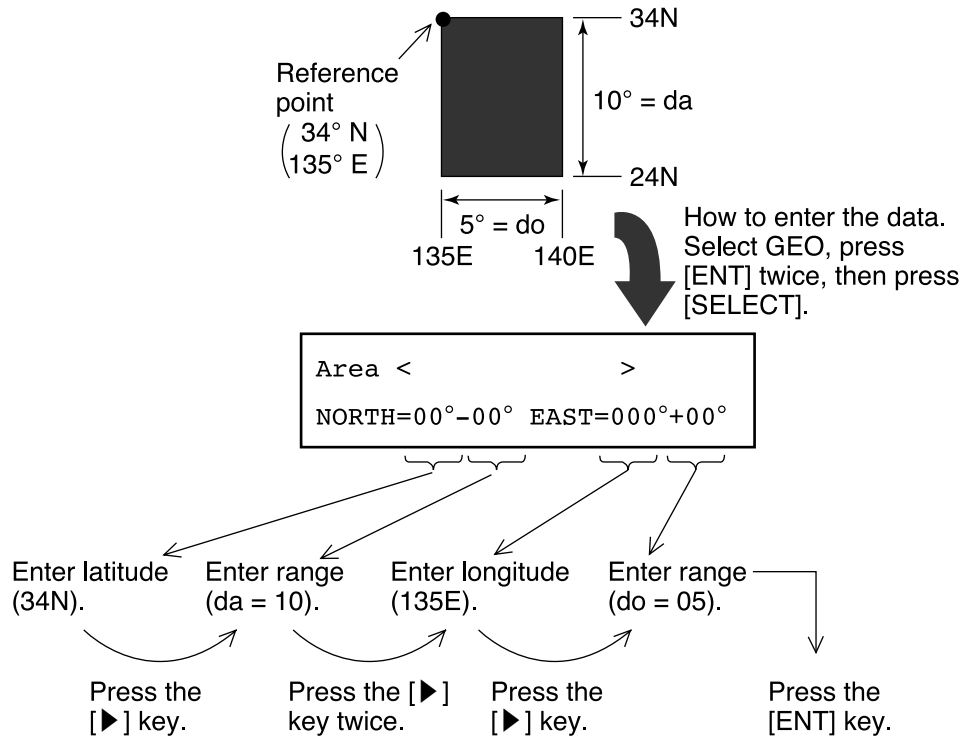

**POS:** **Position request (Individual call).** Find position of other ship by entering its ID number.

**POL:** **Polling call (Individual call).** Confirm that own ship is within communication range with other ship. This function provides only negative response; it does not provide position information.

**MED:** **Medical transport (All ships call).** Inform all ships, by using “urgent” category, that own ship carries medical goods.

**NEU:** **Neutral craft (All ships call).** Inform all ships by Urgency or Safety category, that own ship is not a participant in an armed conflict.

## 5.2 Making Telephone Calls

When the coast station serves PSTN telephone service you can make Telephone Call via Coast Station.

### Basic procedure for making a telephone call

1. Selection of Format specifier.
2. Entry of Coast Station ID.
3. Entry of Telephone number.

### Detailed procedure for making a telephone call

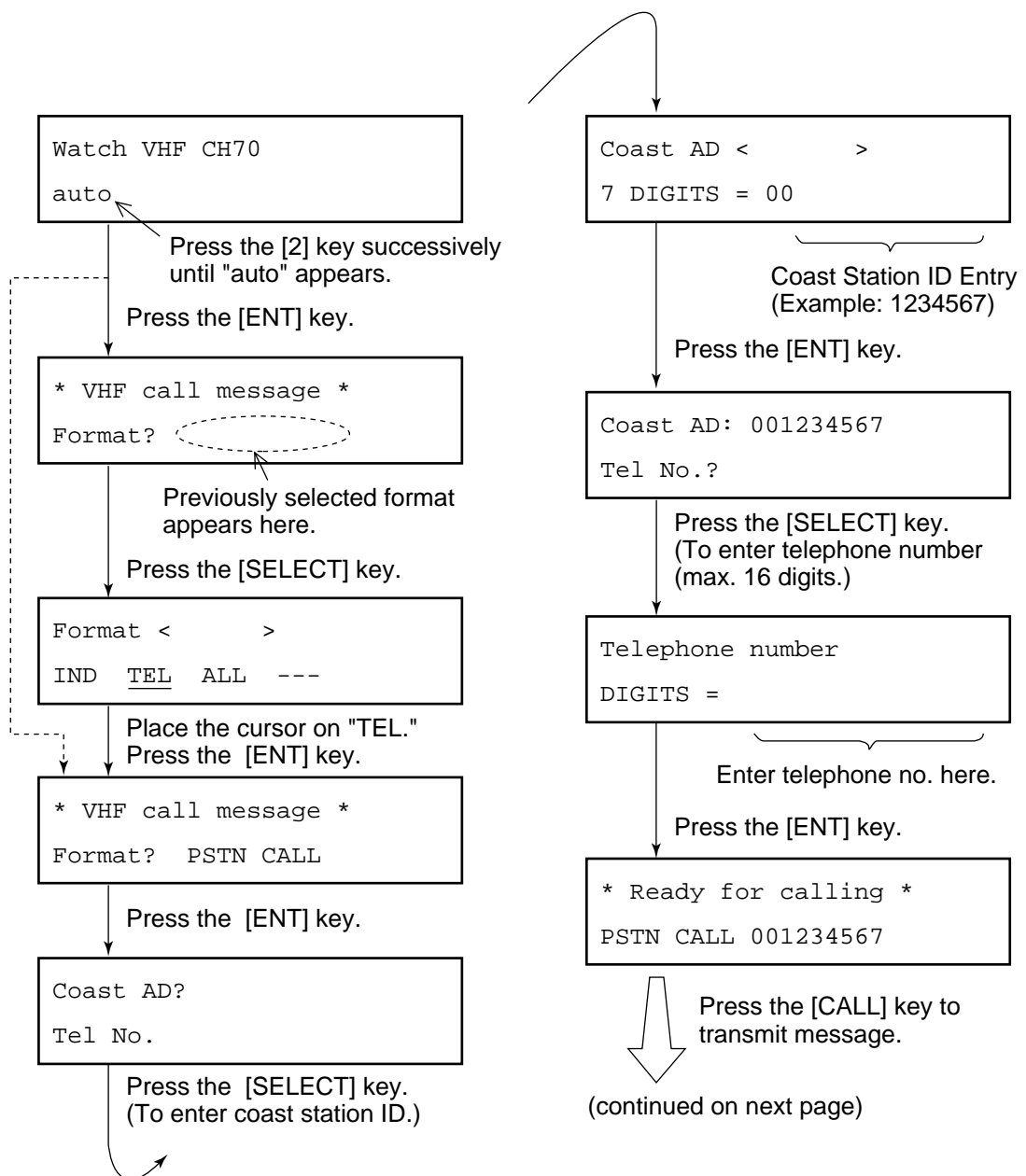

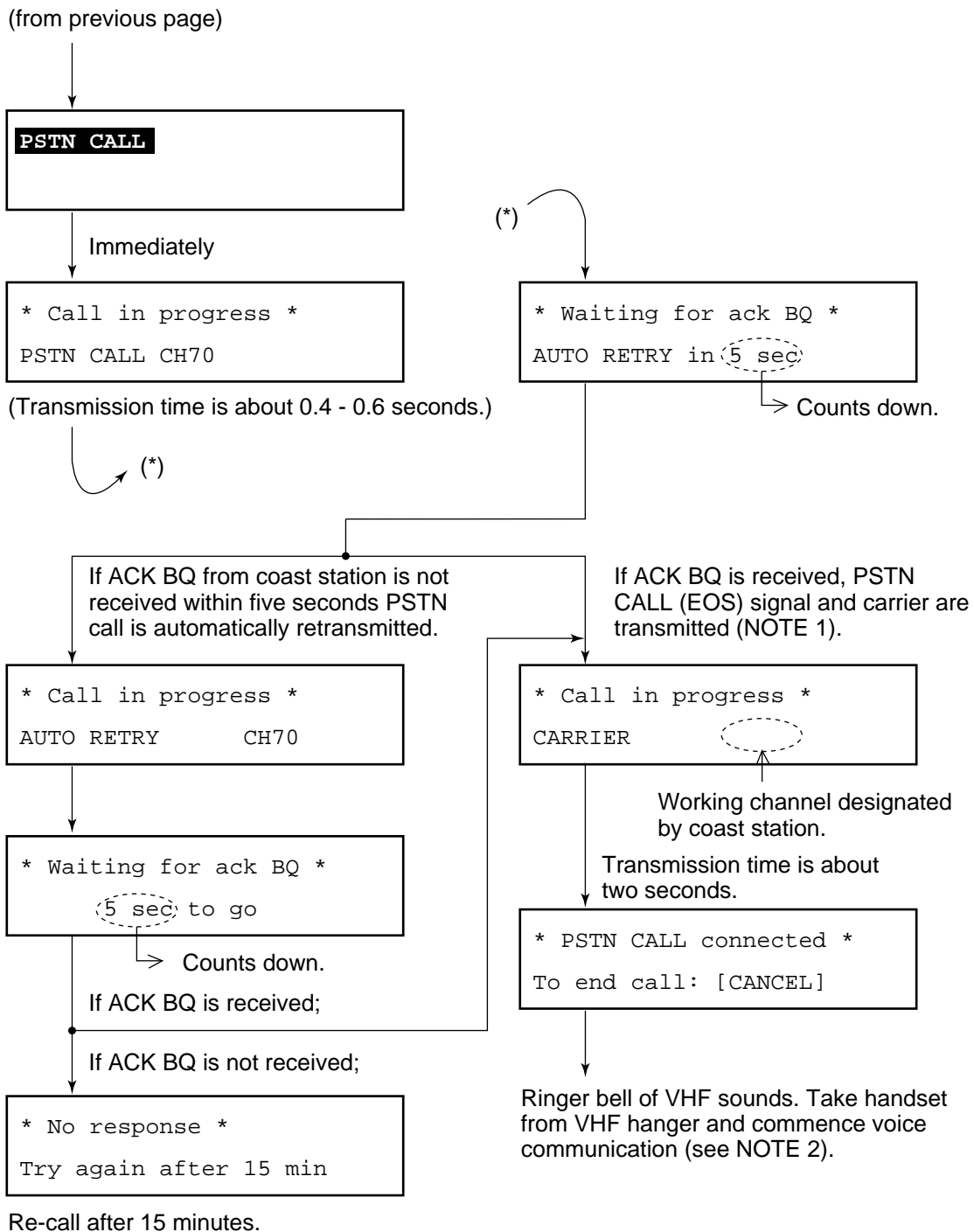

(NOTE 1) When you receive "unable to comply" (BUSY) command instead of "able," the FM-8500 waits for "Ring back call" from coast station for 15.5 minutes. Then, if it is received, carrier is automatically transmitted.

(NOTE 2) If there is no reply (voice response) from subscriber within one minute at "PSTN CALL connected" display, the communication line will be disconnected. The display should look something like the display ② on the page 5-7. If you hang the handset on the hanger, the display ① shown on the next page appears to break the communication line.



## Operation after making DSC telephone call

Voice communication is started. After completion of communication, the display changes as shown in (1) or (2) below depending on how voice communication was terminated.

- (1) When you end voice communication by pressing the [CANCEL] key or hanging the handset on the hanger of the VHF, the display of the FM-8700 changes as follows.

**Note:** If a subscriber hangs the handset on the hanger to terminate voice communication, coast station will transmit the "End of call" command to you to break the communication line.

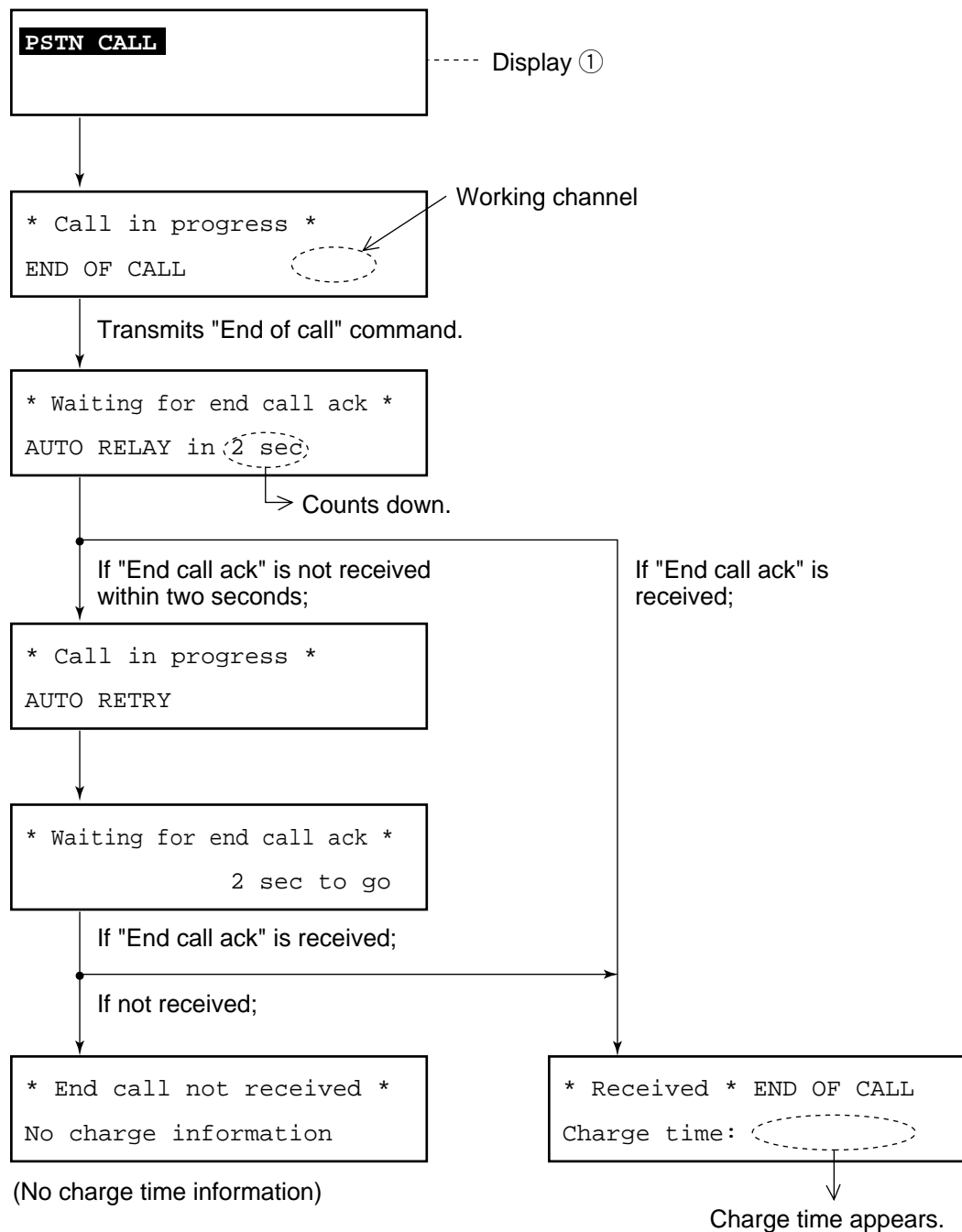

(2) When coast station terminates communication, the display of the FM-8700 is as follows:

When the "End of call" command from coast station is received;

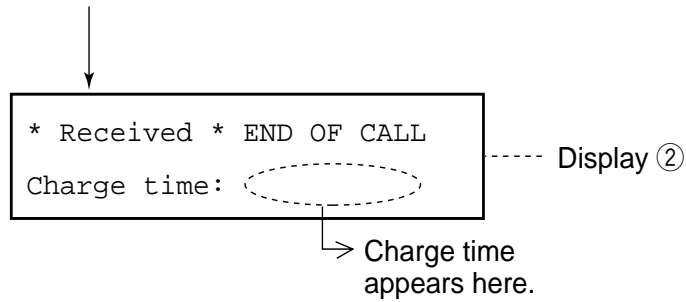

**Note:** If a subscriber hangs the handset on the hanger to terminate voice communications, coast station will transmit the "End of call" command to you to break the communication line.

### 5.3 Receiving Telephone Call from Coast Station

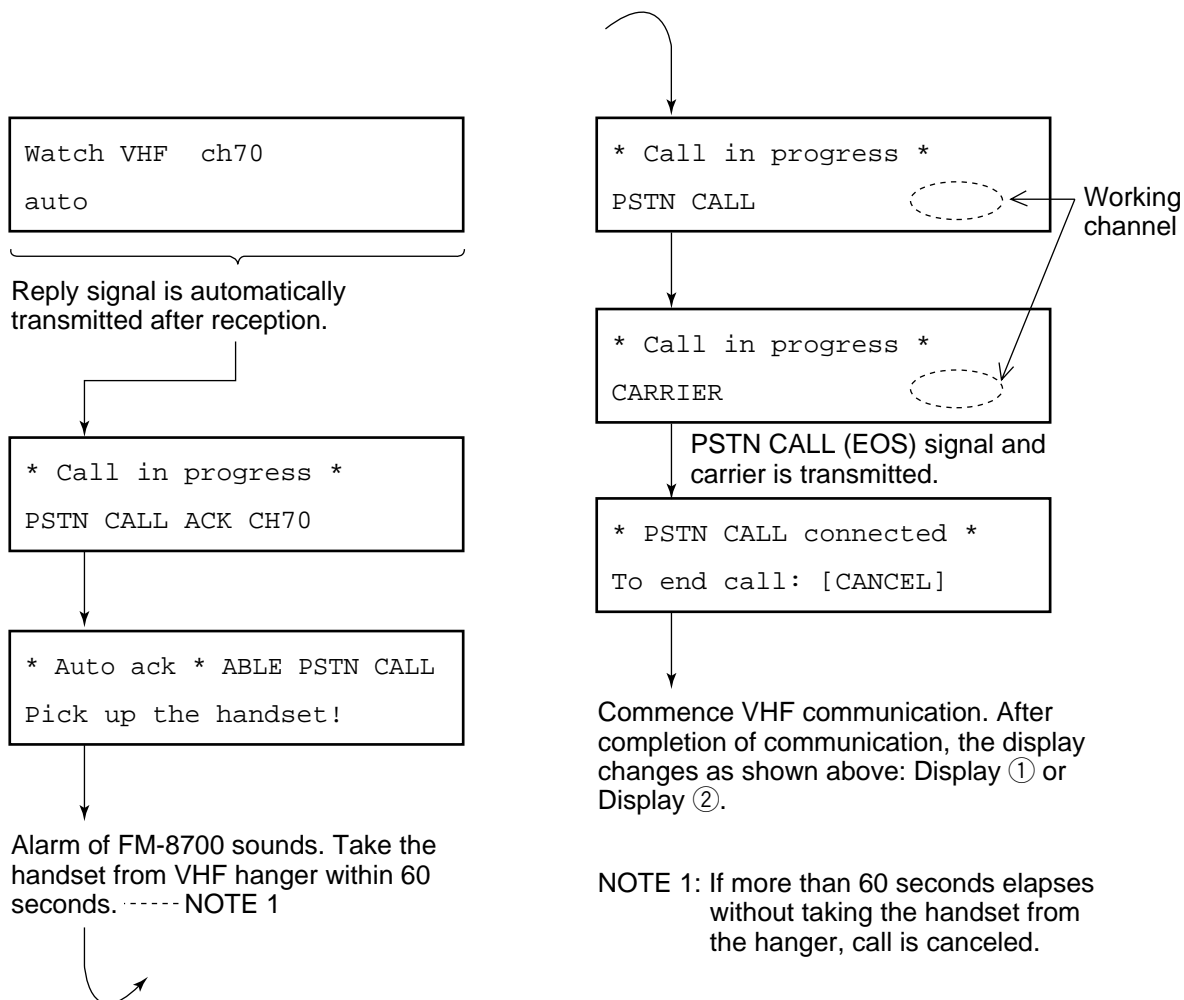

## 5.4 Other Station IDs and Telephone Numbers

### Registering other station IDs, telephone numbers

You can store often-used station IDs and telephone numbers under a file name.

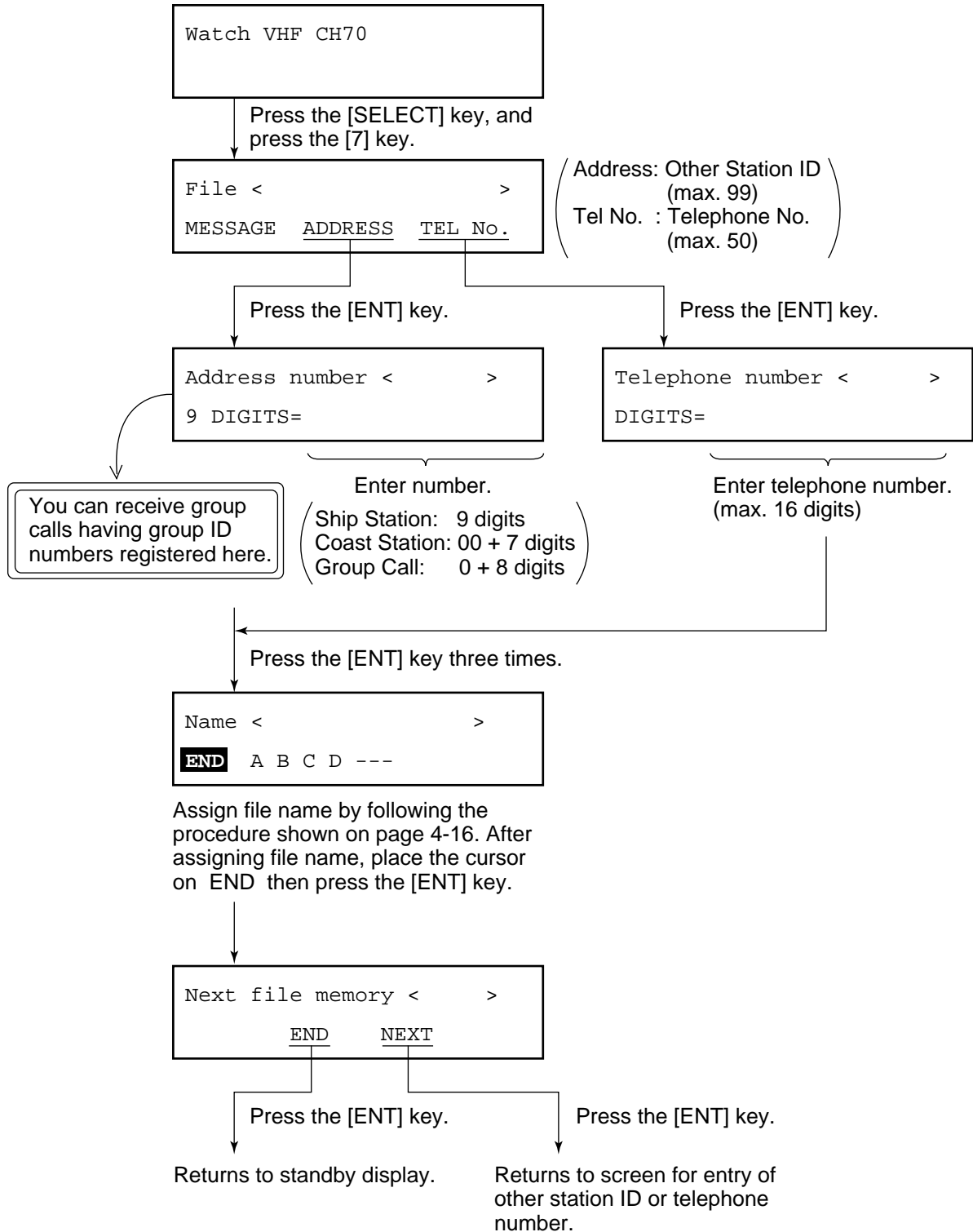

## Opening other station IDs, telephone numbers

You can open a file registered on previous page, and use it with the message which you are currently preparing.

To retrieve a file, first press the [7 (FILE)] key on a display where the blinking question mark appears.

[Example]

### 1. Displaying Other Station ID

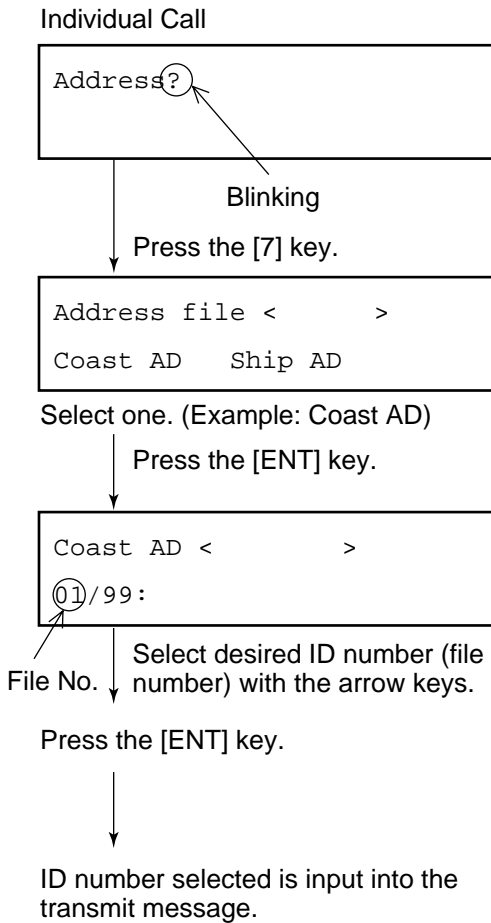

### 2. Displaying Telephone Number

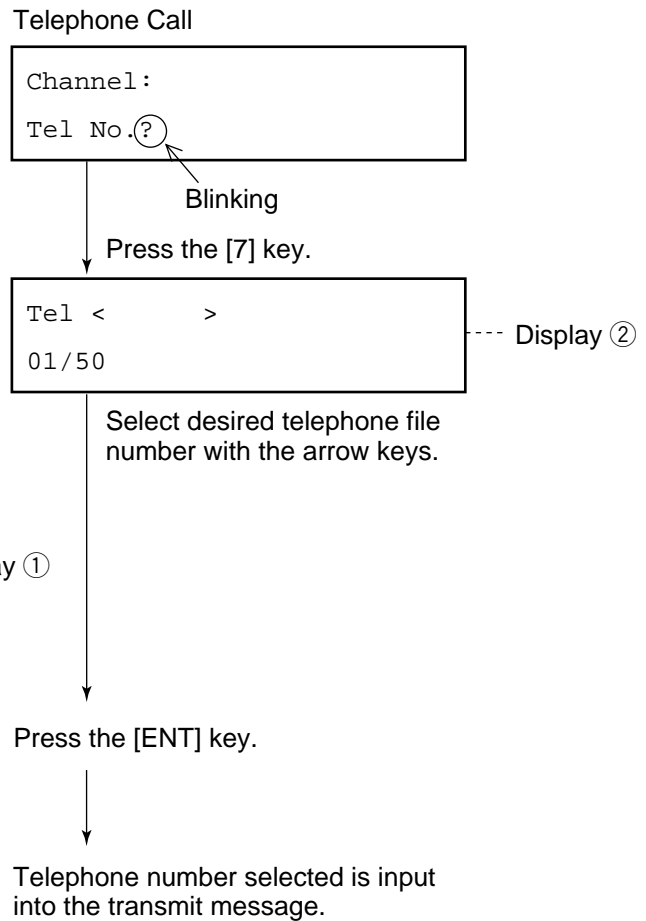

**Note:** Each press of the [SELECT] key at display ① or display ② alternates file number and alphabet-prefixed file name.

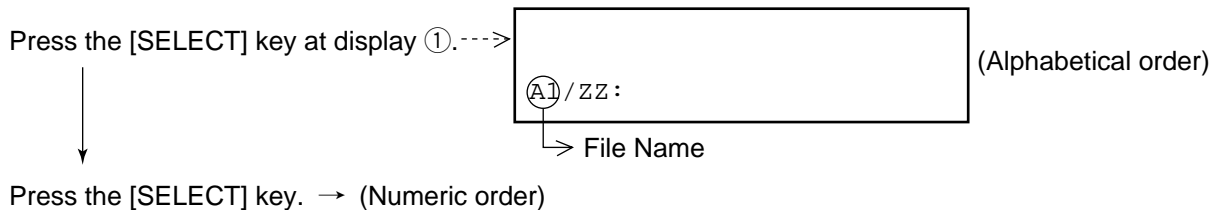

# 6. USER PREFERENCES

## 6.1 Automatic or Manual Printing (Printer setup)

You can select automatic or manual printing as follows. The default setting is “automatic.”

### Selecting automatic or manual printing

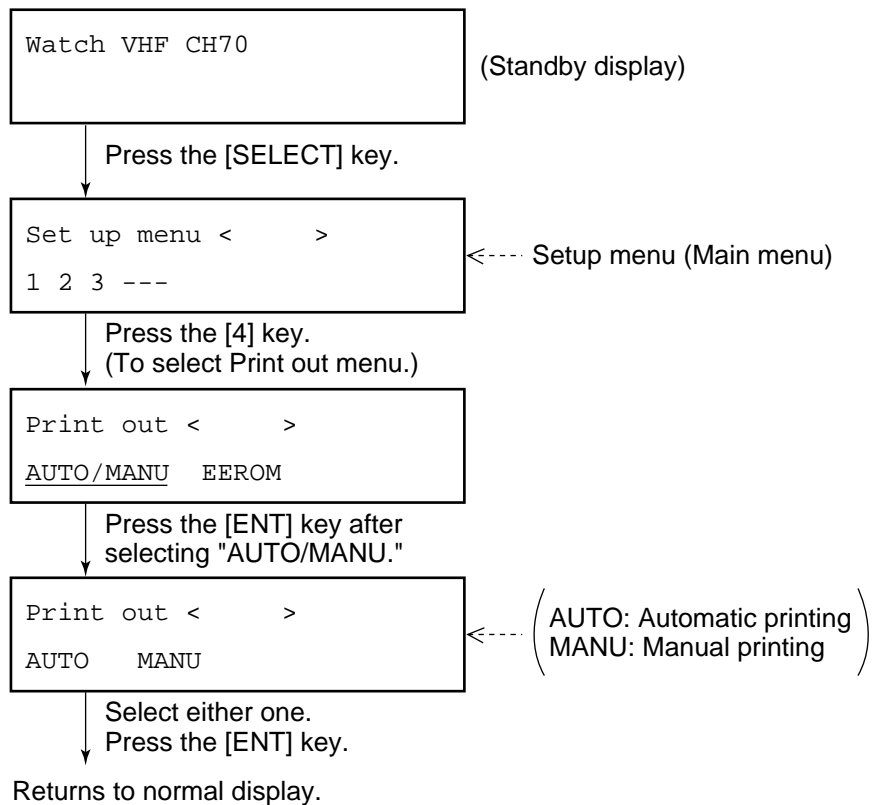

### Automatic printing

With connection of the optional printer and “AUTO” is selected as above, all transmitted and received messages will be automatically printed out when transmitted and received.

## Manual printing

When “Manual” is selected, press the [4 (PRINT)] key to print out message desired. Note that manual printing is available even when “AUTO” is selected.

The contents to be printed depend on when the [4] key is pressed, as shown in the table below.

No.	Printing	Timing of [4] key pressing	Example Printout
1	Contents of {VHF call message}	During “VHF call message” display to “Ready for calling” display	Ⓐ
2	Contents of all transmitted logs {Xmitted log No. < >}	Displayed [Xmitted log No. < >] (To stop printing, press the [CANCEL] key.)	Ⓑ
3	Contents of specific log no. (for example, log no. 1) {Xmitted log No. <1/50> Press the [ENT] key.	During “[Xmitted...] ⇨ Press the [ENT] key.” display to “EOS” display.	Ⓒ
4	Call message (again) Call again CALL END... Press the [ENT] key.	Channel? to Ready for calling While these displays appears	Ⓐ
5	Contents of all received logs {Ordinary log No. < > (Distress)}	Displayed [Ordinary log No. < >] (Distress) (To stop printing, press the [CANCEL] key.)	Ⓓ
6	Contents of specific log no. (for example, log no. 1) {Ordinary log No. <1/50> (Distress)}	[Ordinary... ] display ⇨ Press the [ENT] key.	Ⓔ
7	① Currently received message * Received * Press the [ENT] key.	* Received * to ECC: OK While these displays appears	
	② Acknowledge message Acknowledge call < >	“Ready for calling” is displayed.	Ⓕ
8	Contents of currently prepared {VHF call message M}	During “VHF call message M” display to “Ready for filing” display.	Ⓖ
9	All lists of {saved message} or contents of all {Address or Tel No.} files. • Press the [SELECT] key. ⇨ Press the [7] key. File < > Message Address Tel No.	• For example, to print out all coast addresses in the memory, press the [4] key at display ① on page 5-9. Press the [4] key to print out all list of saved messages.	Ⓖ

## Example printouts

(a)

```
Format : INDIVIDUAL
Address : 000000000
Category : Routine
Telecom1 : DUPLEX TP
Telecom2 : RES No.18
Channel : 23
EOS : ACK RQ
ECC : .....

DSC ch : 70
```

(b)

```
***** Xmitted log *****
Xmt message 12:34
Format : INDIVIDUAL
Address : 004310000
Category : Routine
Telecom1 : DUPLEX TP
Telecom2 : RES No.18
Channel : 23
EOS : ACK BQ

DSC ch : 70
```

(c)

```
Xmt message 00:09
Format : INDIVIDUAL
Address : 004310000
Category : Routine
Telecom1 : DUPLEX TP
Telecom2 : RES No.18
Channel : 23
EOS : ACK RQ

DSC ch : 70
```

(d)

```
***** Ordinary log *****
Rcv message 02:04
Format : ALL SHIPS
Category : Safety
Telecom1 : SIMPLEX TP
Telecom2 : RES No.18
Channel : 16
EOS : EOS
ECC : OK

DSC ch : 70

Xmt message 02:03
Format : INDIVIDUAL
Address : 004310000
Category : Safety
Telecom1 : SIMPLEX TP
Telecom2 : RES No.18
Channel : No information
EOS : ACK RQ
ECC : OK

DSC ch : 70
```

(e)

```
Rcv message 00:07
Format : INDIVIDUAL
Address : 431000001
Category : Routine
Telecom1 : DUPLEX TP
Telecom2 : RES No.18
Channel : 23
EOS : ACK RQ
ECC : OK

DSC ch : 70
```

(f)

```
Format : INDIVIDUAL
Address : 431000001
Category : Routine
Telecom1 : DUPLEX TP
Telecom2 : RES No.18
Channel : 23
EOS : ACK BQ

DSC ch : 70
```

(g)

```
Format : INDIVIDUAL
Address : 000000000
Category : Routine
Telecom1 : DUPLEX TP
Telecom2 : RES No.18
Channel : 23
EOS : ACK RQ
ECC : OK

DSC ch : 70
```

(e)

```
***** Call message file *****
01: FURUNO Individual
02: CAPTAIN All ships
```

## 6.2 Turning Key Beep On/Off

You can turn on/off the beep tone which sounds when a key is pressed.

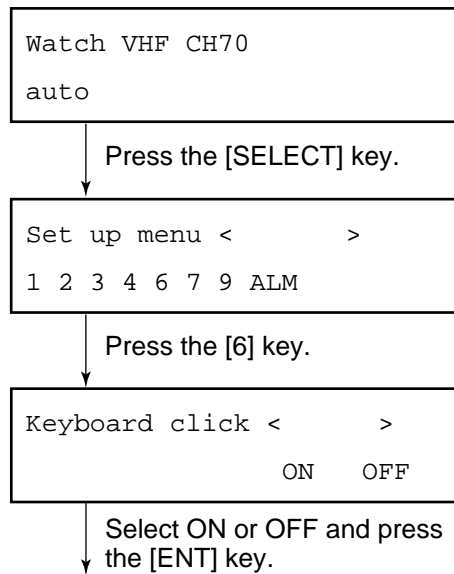

Standby display appears.



# 6.3 Alarm Setup

The receive alarm, which sounds when messages other than distress and urgency are received, may be turned on or off. Furthermore, the distress (and urgency) alarm tone may be selected.

## How to turn receive alarm on/off, select distress alarm tone

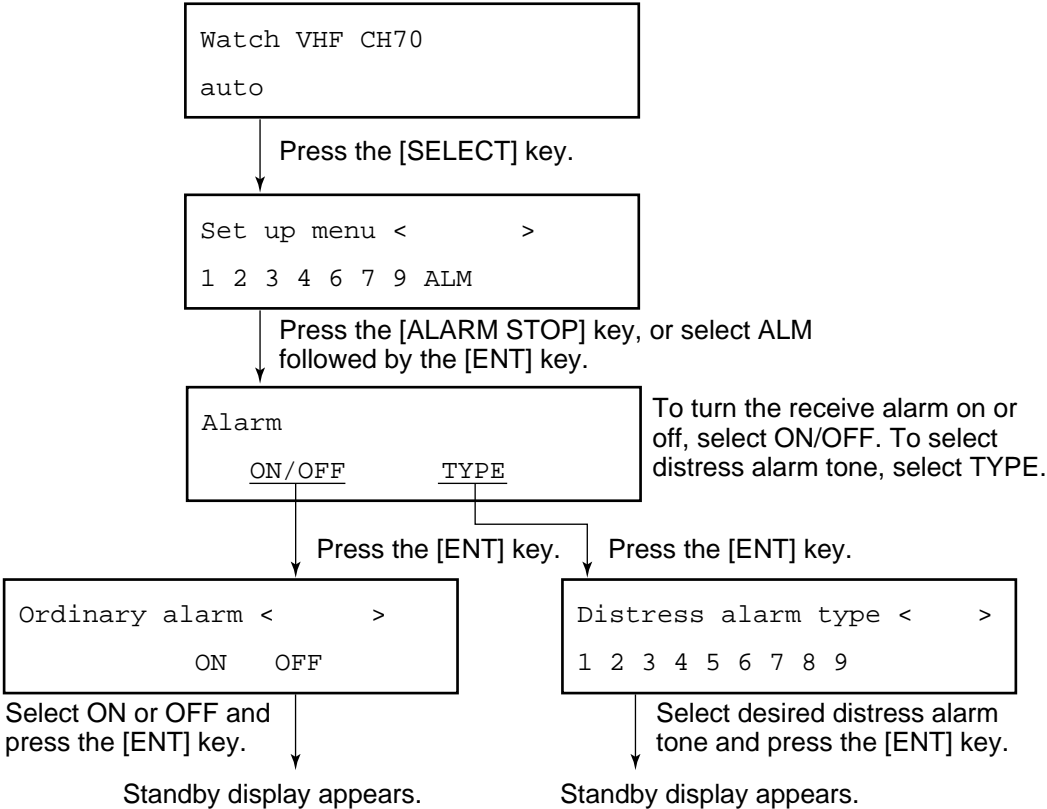

This page is intentionally left blank.

# 7. SYSTEM CONFIRMATION

---

## 7.1 Confirming Own Ship's ID

Own ship's ID can be confirmed as follows:

### How to confirm own ship's ID

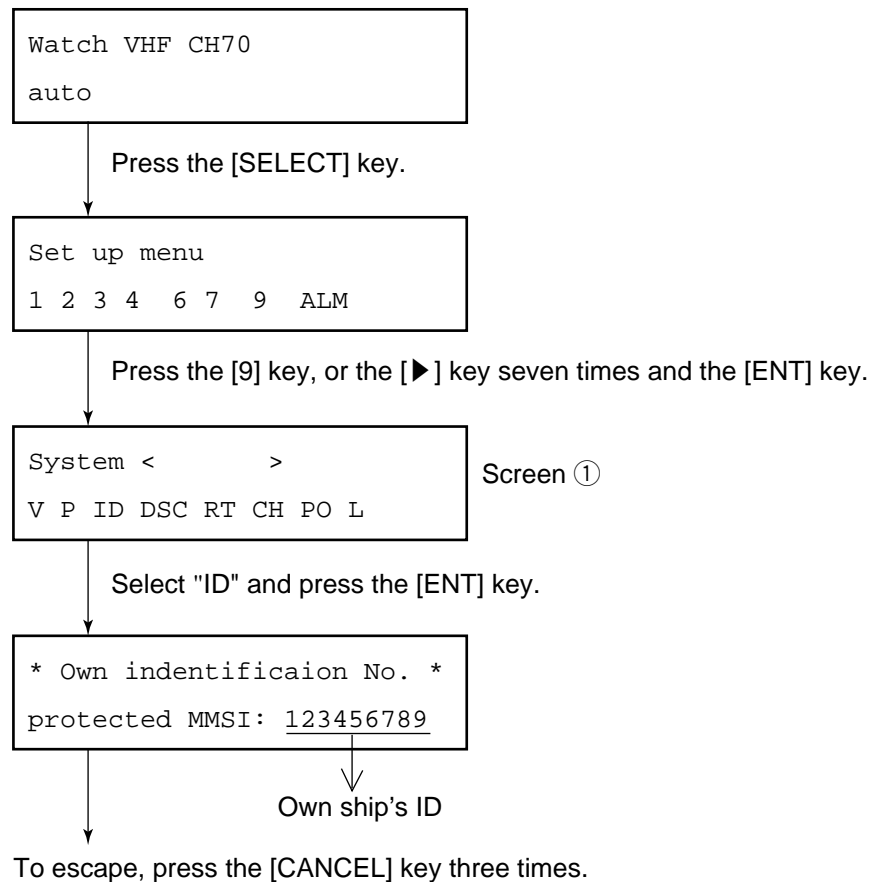

## 7.2 Confirming ROM Version No.

You can see the ROM version no. (as registered in the memory) as follows:

### How to confirm ROM version no.

At screen ① previous page, select “V” and press the [ENT] key. Then, follow the procedure below.

```
ROM version
  RT:1.04   DSC:1.04
```

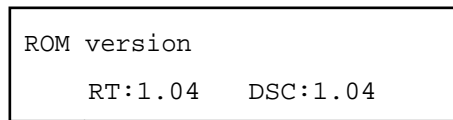

To escape, press the [CANCEL] key three times.

RT: VHF section's ROM version  
DSC: DSC section's ROM version

## 7.3 Confirming VHF Section Settings

You can confirm VHF section settings as shown below. To change VHF section settings, contact FURUNO agent or dealer for service.

### How to confirm VHF section settings

At screen ① on page 7-1, select “RT” and press the [ENT] key. Then, follow the procedure below.

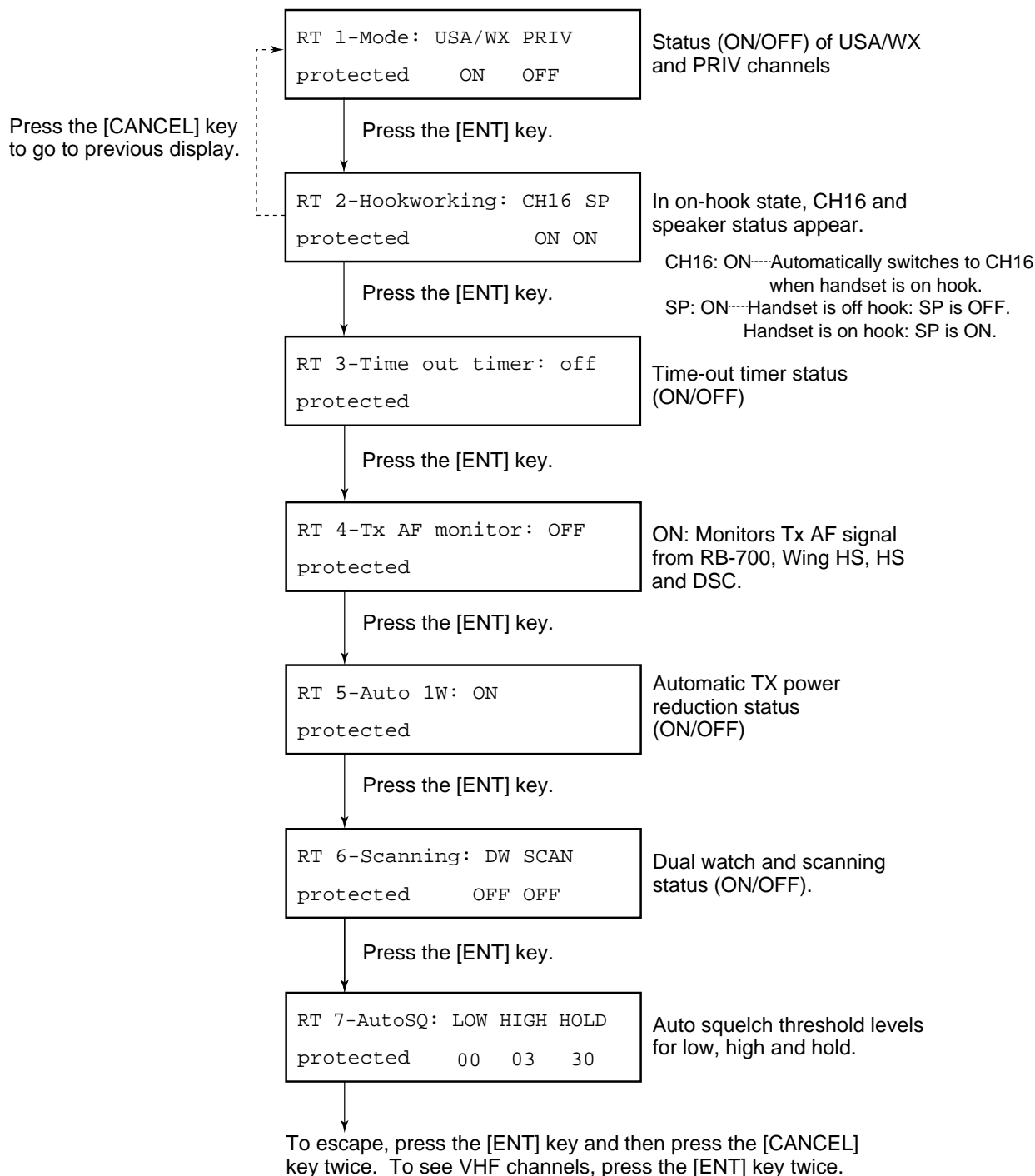

## 7.4 Confirming VHF Channels

You can confirm VHF channels registered as follows:

### How to confirm VHF channels

At screen ①, select “CH” and press the [ENT] key. Then, follow the procedure below.

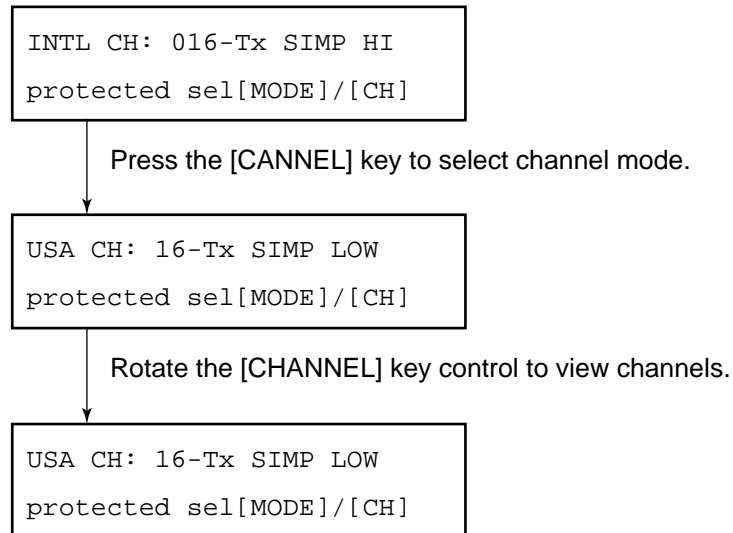

Do one of the following:

Continue channel confirmation: Operate the [CHANNEL] key.

Escape: Press the [CANCEL] key.

Confirm Tx power: Press the [ENT] key twice.

### VHF channel status

Tx: Tx/Rx	SIMP (Simplex)	HI (25 W)
Rx: Rx only	DUP (Duplex)	LOW (1 W)
Unable: Channel not used		

## 7.5 Confirming Tx Output Power

The Tx output power on three VHF bands (low, CH60; med, CH14, high, CH88) can be confirmed as shown below. Tx output power on private mode channels can also be confirmed if applicable.

### How to confirm Tx output power

At screen ① on page 7-1, select “PO” and press the [ENT] key. Then, follow the procedure below.

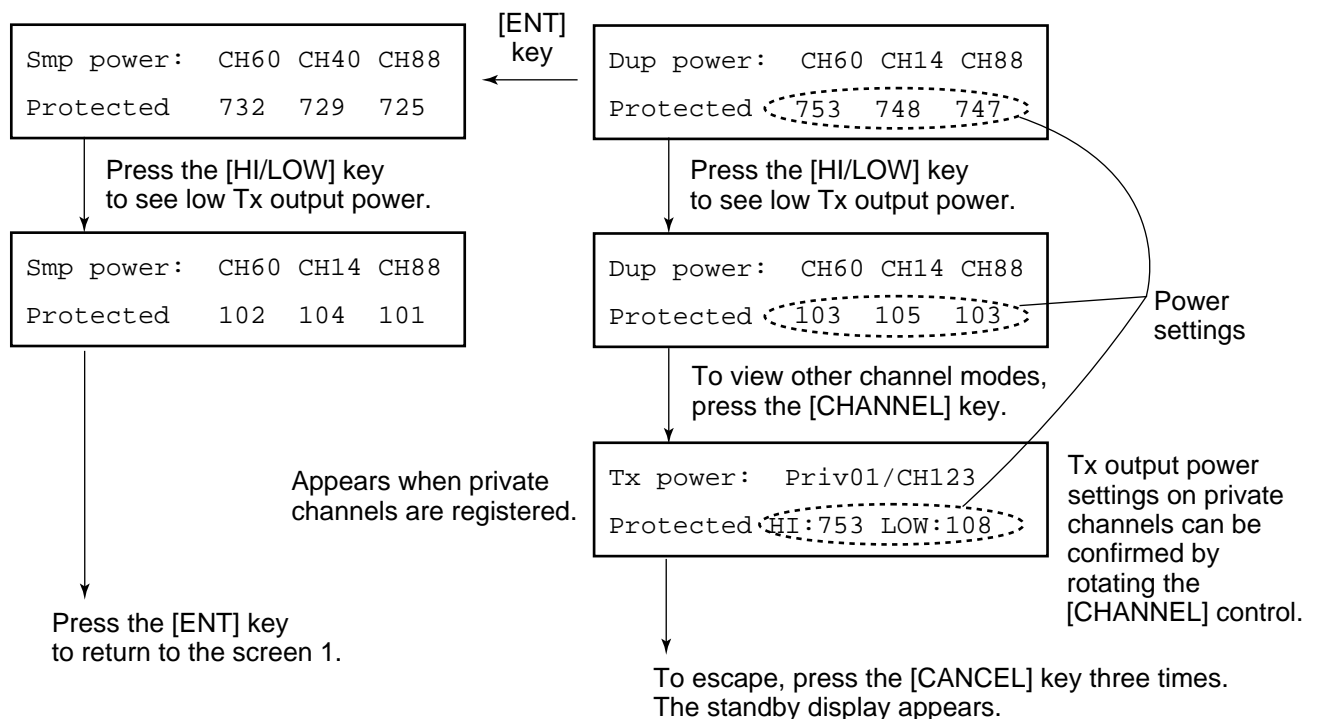

This page is intentionally left blank.



# 8. MAINTENANCE & TROUBLESHOOTING

---

## 8.1 Maintenance

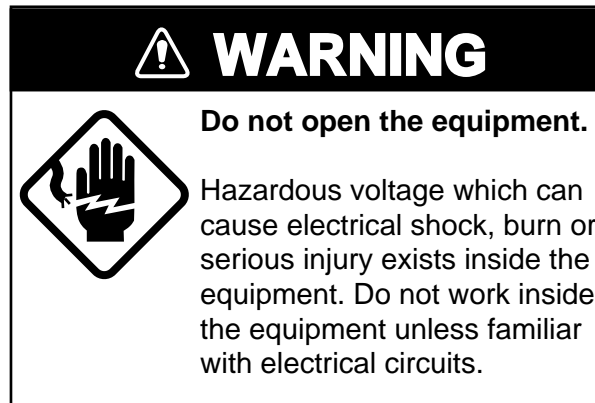

### Periodic checks

1. Check that each connector is firmly connected.
2. Clean corroded or soiled connectors.
3. Check coaxial cable for damage. If damaged, replace.
4. Check that bolts fixing the antenna are firmly tightened.

## 8.2 Troubleshooting

### When the power cannot be turned on

1. Check if power plug is firmly connected.
2. Check breaker at the rear of the equipment. If it has tripped, push it in to reset.
3. If power cannot be turned on, contact a FURUNO agent or representative.

## 8.3 Diagnostic Test

Regulations require that the DSC section be checked daily for proper operation.

### How to start the diagnostic tests

Select a channel not in use and press and hold down the PTT switch of the handset for more than one second before starting the test.

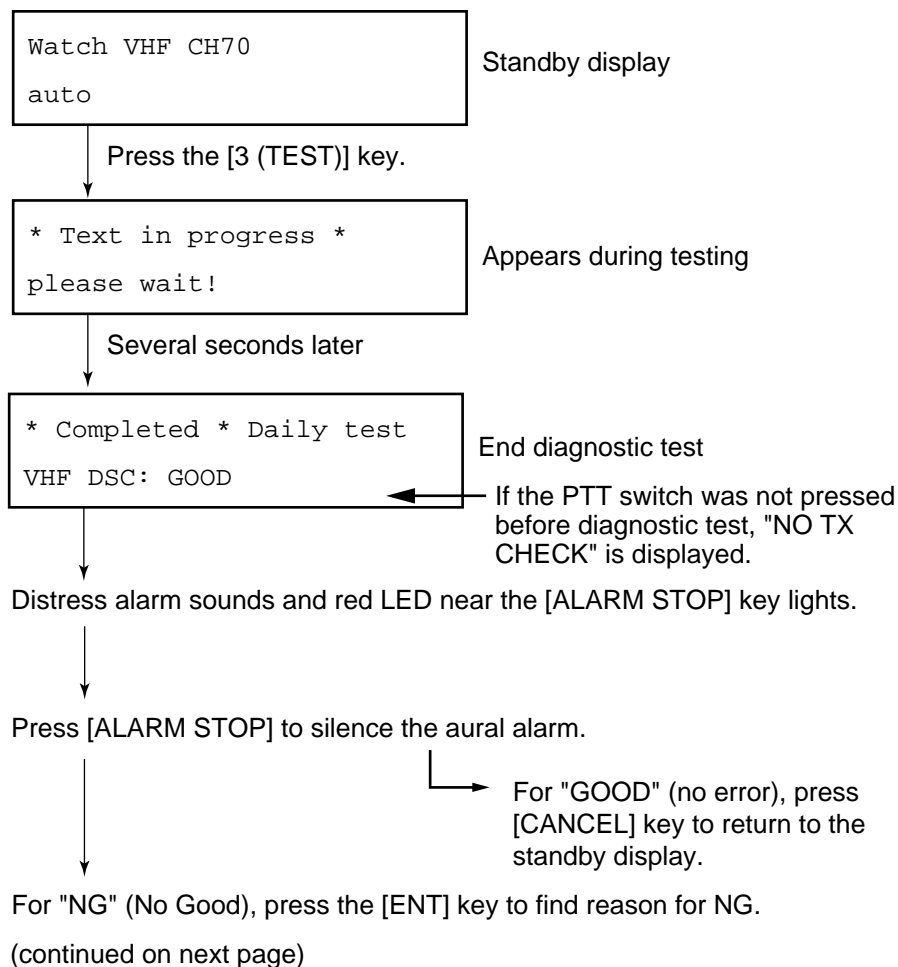

(from previous page)

↓  
Press [ENT] to view results of test.

↓  
*This area shows test results:  
OK for normal operation; NG  
(No Good) for error.*

↓  
Check end: [CANCEL] key

NG display and PCB error

TRANSMIT POWER: NG  
= P.A. of transmission section  
TX PCB error

TX PCB: NG  
= TX PCB error

CONTROL PCB: NG  
= MODEM(U29) Control PCB error  
or

CH70 Rx PCB: NG  
= CH70 RX PCB error

RX PCB: NG  
= RX PCB error

DUPLEXER PCB: NG  
= DUPLEXER PCB error

To escape, press the [CANCEL] key.  
If NG appears, have a technician replace corresponding PCB.

This page is intentionally left blank.

# SPECIFICATIONS OF MARINE VHF RADIOTELEPHONE FM-8700

## 1. GENERAL

(1) Number of Channels	INTL: 55 USA: 55 Weather: 10 Private: 20
(2) Frequency Stability	Within $\pm 1.5$ kHz
(3) Communication System	Full-duplex/Semi-duplex/Simplex
(4) Class of Emission	G3E (Voice) G2B (DSC)
(5) Antenna Impedance	50 ohms

## 2. TRANSMITTER

(1) Frequency Range	155.000 to 161.475 MHz
(2) Output Power	25 W max., 1 W at power reduction
(3) Frequency Deviation	$\pm 5$ kHz

## 3. RECEIVER

(1) Frequency Range	155.000 to 166.075 MHz
(2) Receiving System	Double Super heterodyne
(3) Intermediate Frequency	1st: 21.4MHz 2nd: 455 kHz
(4) Sensitivity	-8 dB $\mu$ V (12 dB SINAD)
(5) Adjacent Channel Selectivity	70 dB or more
(6) Spurious Response	70 dB or more
(7) AF output	Built-in Speaker: 2 W (8 ohms)

## 4. DSC

(1) Protocol	ITU-R Rec. 541-7, 493-8 (class A) and 689
(2) Baud Rate	1200 baud $\pm 30$ ppm max.
(3) Modulation	AFSK
(4) Frequency Shift	1700 $\pm 400$ Hz Mark: 1300 Hz Space: 2100 Hz
(5) Navigation Data	NMEA0183

## 5. CH70 WATCH RECEIVER

- (1) Receiving Frequency 156.525 MHz
- (2) Sensitivity Symbol error rate: less than 1% (at 0 dBμV)
- (3) Conducted Spurious Emission  
Less than 2 nW

## 6. POWER REQUIREMENTS

- (1) Power Supply 24 VDC, +30% -10%
- (2) Power Consumption Transmit: 170 W  
Receive: 25 W

## 7. DIMENSIONS & MASS

See outline drawings

## 8. ENVIRONMENTAL CONDITIONS

- (1) Temperature -15°C to 55°C (IEC945)
- (2) Relative Humidity 93% (at 40°C)
- (3) Waterproofing  
Transceiver Unit Chassis: IEC529 IPX2  
Panel: IEC529 IPX4  
Duplexer Unit IEC529 IPX2

## 9. COATING COLOR

- (1) Transceiver Unit Chassis: Munsell 2.5GY5/1.5  
Panel: Munsell N3.0
- (2) Duplexer Unit Munsell 2.5GY5/1.5

# APPENDIX

## Menu Tree

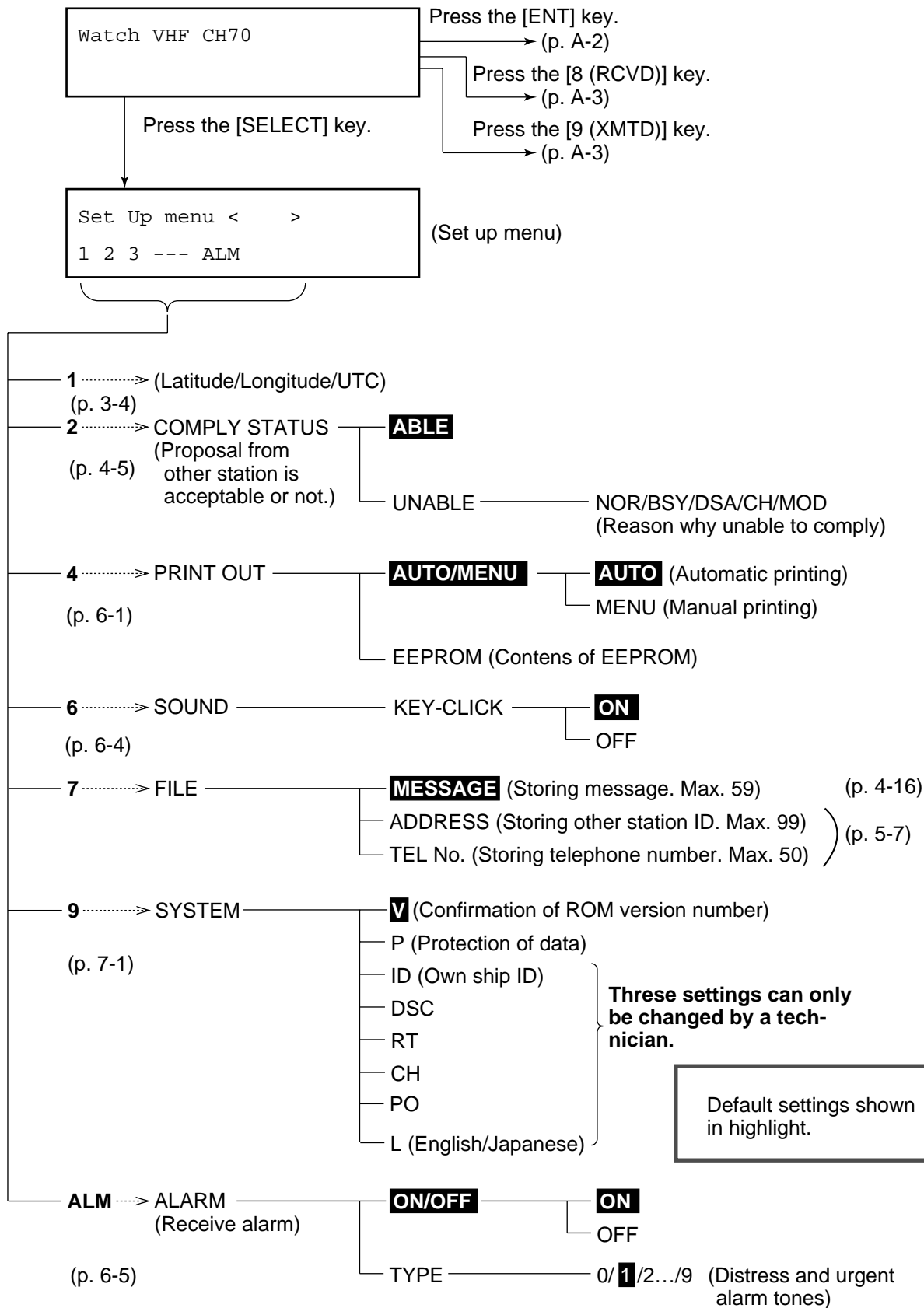

Standby display

Press the [ENT] key.

\* VHF Call message \*  
Format ?

(Preparing transmit message)

FORMAT

- INDIVIDUAL — ADDRESS — CATEGORY — TELECOM — WORKING CH
- TELEPHONE — COAST ADDR — TEL NO.  
(DIALPHONE)
- ALL SHIPS — CATEGORY — TELECOM — WORKING CH
- R/A (DISTRESS RELAY ALL SHIPS) — DIST SHIP ID — N. OF DIST — POS & TIME
- R/S (DISTRESS RELAY INDIVIDUAL) — COAST ADDR
- DISTRESS — NATURE OF DISTRESS — POSITION & TIME
- GROUP — GROUP ADDR — CATEGORY — TELECOM — WORKING CH
- GEOGRAPHIC AREA  
— OCEAN ADDR — CATEGORY — TELECOM — WORKING CH
- POSITION REQUEST — ADDR — CATEGORY — TELECOM (POSITION)  
(Normally ROUTINE)
- POLLING — ADDR — CATEGORY — TELECOM (POLLING)  
(Normally ROUTINE)
- MEDICAL TRANSPORT — TELECOM — WORKING CH
- NEURAL CRAFT — CATEGORY — WORKING CH



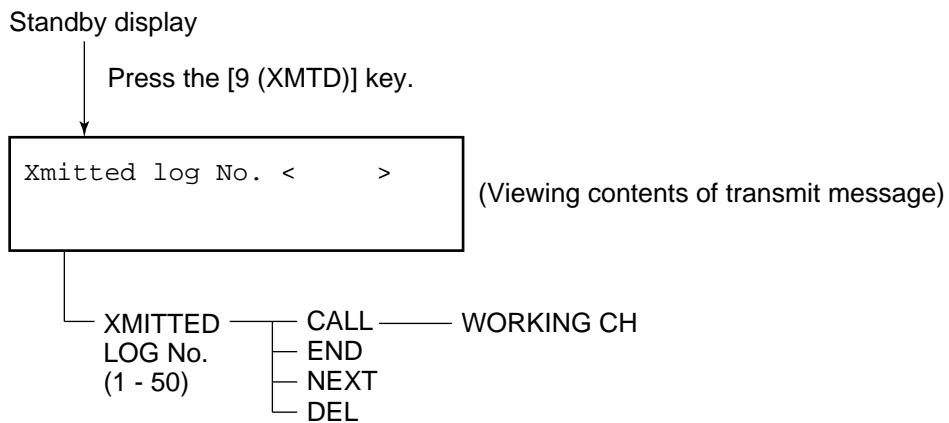
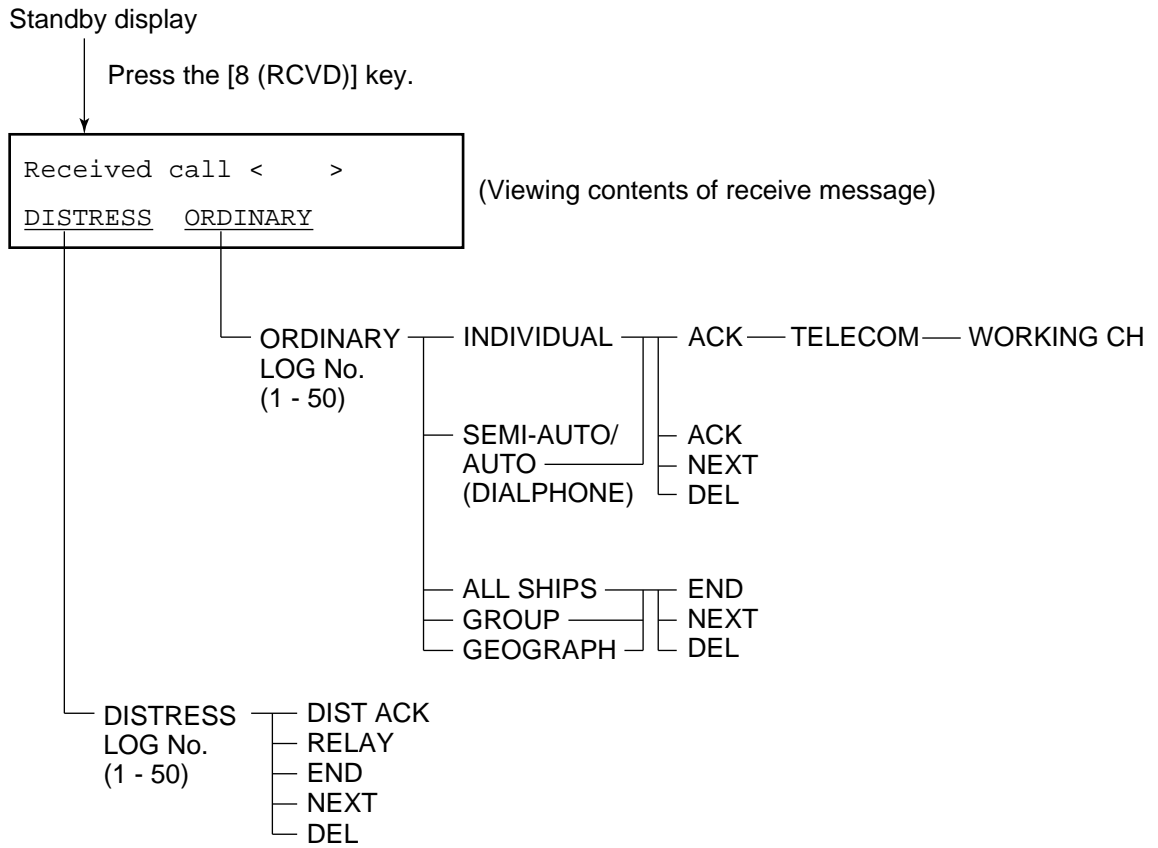

# Marine VHF Channel Lists

## MARINE VHF CHANNEL FREQUENCIES (INTERNATIONAL version)

CH NO	Ship TX	Ship RX	Type of operation
01	156.050	160.650	Public Correspondence, Port Operation
02	156.100	160.700	Public Correspondence, Port Operation
03	156.150	160.750	Public Correspondence, Port Operation
04	156.200	160.800	Public Correspondence, Port Operation
05	156.250	160.850	Public Correspondence, Port Operation
06	156.300	156.300	Safety
07	156.350	160.950	Public Correspondence, Port Operation
08	156.400	156.400	Intership
09	156.450	156.450	Port Operation
10	156.500	156.500	Port Operation
11	156.550	156.550	Port Operation
12	156.600	156.600	Port Operation
13	156.650	156.650	Bridge-to-bridge, Navigational, 1W
14	156.700	156.700	Port Operation
15	156.750	156.750	Coast-to-ship, 1W
16	156.800	156.800	Distress, Safety and Calling
17	156.850	156.850	State-controlled, Ship-to-coast, 1W
18	156.900	161.500	Port Operation
19	156.950	161.550	Port Operation
20	157.000	161.600	Port Operation
21	157.050	161.650	Port Operation
22	157.100	161.700	Port Operation
23	157.150	161.750	Public Correspondence
24	157.200	161.800	Public Correspondence
25	157.250	161.850	Public Correspondence
26	157.300	161.900	Public Correspondence
27	157.350	161.950	Public Correspondence
28	157.400	162.000	Public Correspondence
60	156.025	160.625	Public Correspondence, Port Operation
61	156.075	160.675	Public Correspondence, Port Operation
62	156.125	160.725	Public Correspondence, Port Operation
63	156.175	160.775	Public Correspondence, Port Operation
64	156.225	160.825	Public Correspondence, Port Operation
65	156.275	160.875	Public Correspondence, Port Operation
66	156.325	160.925	Public Correspondence, Port Operation

67	156.375	156.375	Port Operation
68	156.425	156.425	Port Operation
69	156.475	156.475	Port Operation
70*	156.525	156.525	* For DSC ONLY
71	156.575	156.575	Internship, Port Operation
72	156.625	156.625	Internship
73	156.675	156.675	Port Operation
74	156.725	156.725	Port Operation
75			Guard band
76			
77	156.875	156.875	Internship, 1W (In USA, Pilot and docking :1 W)
78	156.925	161.525	Port Operation
79	156.975	161.575	Port Operation
80	157.025	161.625	Port Operation
81	157.075	161.675	Port Operation
82	157.125	161.725	Port Operation, Public Correspondence
83	157.175	161.775	Public Correspondence
84	157.225	161.825	Port Operation, Public Correspondence
85	157.275	161.875	Public Correspondence
86	157.325	161.925	Public Correspondence
87	157.375	161.975	Public Correspondence
88	157.425	162.025	Public Correspondence

---

\* NOTE:

---

22A	157.100	157.100	Port safety. USCG requires in foreign vessels, too, in US navigable waters. Accessible by [M] keyoperation.
-----	---------	---------	---

---

## MARINE VHF CHANNEL FREQUENCIES (USA version)

CH NO	Ship TX	Ship RX	Type of operation
01A	156.050	156.050	Port Operation, Commercial
02	156.100	160.700	Port Operation, Commercial
03	156.150	160.750	Port Operation, Commercial
04	156.200	160.800	Port Operation, Commercial
05A	156.250	156.250	Port Operation, Commercial
06	156.300	156.300	Safety, Intership
07A	156.350	156.350	Commercial
08	156.400	-	Intership
09	156.450	156.450	Commercial and Non-commercial
10	156.500	156.500	Commercial
11	156.550	156.550	Commercial
12	156.600	156.600	Port Operation
13	156.650	156.650	Bridge-to-bridge, Normally low output; manual override for high.
14	156.700	156.700	Port Operation
15		156.750	Environmental (Receive only)
16	156.800	156.800	Distress, Safety and Calling
17	156.850	156.850	State-controlled, Ship-to-coast, 1W
18A	156.900	156.900	Commercial
19A	156.950	156.950	Commercial
20A	157.000	-	Intership only
21	157.050	161.650	US Government
22A	157.100	157.100	Port safety (Required in foreign vessels, too)
23A	157.150	157.150	Public Correspondence
24	157.200	161.800	Public Correspondence
25	157.250	161.850	Public Correspondence
26	157.300	161.900	Public Correspondence
27	157.350	161.950	Public Correspondence
28	157.400	162.000	Public Correspondence
60	156.025	160.625	Public Correspondence, Port Operation
61	156.075	160.675	Public Correspondence, Port Operation
62	156.125	160.725	Public Correspondence, Port Operation
63A	156.175	156.175	Public Correspondence, Port Operation
64	156.225	160.825	Public Correspondence, Port Operation
65A	156.275	156.275	Public Correspondence, Port Operation
66A	156.325	156.325	Public Correspondence, Port Operation
67	156.375	156.375	Navigational, Intership. Normally low output; manual override for high.
68	156.425	156.425	Non-commercial

69	156.475	156.475	Non-commercial
70*	156.525	156.525	For DSC ONLY
71	156.575	156.575	Non-commercial
72	156.625	-	Intership only
73	156.675	156.675	Port Operation
74	156.725	156.725	Port Operation
75			
76			
77	156.875	156.875	Pilot, Docking operation (Intership), 1W
78A	156.925	156.925	Non-commercial
79A	156.975	156.975	Commercial
80A	157.025	157.025	Commercial
81A	157.075	157.075	US Governmental
82A	157.125	157.125	US Governmental
83A	157.175	157.175	US Governmental
84	157.225	161.825	Public Correspondence
85	157.275	161.875	Public Correspondence
86	157.325	161.925	Public Correspondence
87	157.375	161.975	Public Correspondence
88A	157.425	157.425	Commercial (Intership)

### **WEATHER CHANNELS (Included in US version)**

WX1	162.550	Weather (Receive only)	WX6	162.500	Weather (Receive only)
WX2	162.400	Weather (Receive only)	WX7	162.525	Weather (Receive only)
WX3	162.475	Weather (Receive only)	WX8	162.650	Weather (Receive only)
WX4	162.425	Weather (Receive only)	WX9	161.775	Weather (Receive only)
WX5	162.450	Weather (Receive only)	WX0	163.275	Weather (Receive only)

### **PRIVATE CHANNELS (U.K. MARINERS)**

Key Sequence		Ship Transmit	Ship Recive	Application
	Coast Guard 00	156.000	156.000	for contact with U.K. C.G
	M1 (37P)	157.850	157.850	for pleasure boat
	M2	161.425	161.425	for pleasure boat
	CH 80 UK (u)	161.625	157.025	for UK marina to contact foreign yachtsmen on ITU CH 80

### PRIVATE CHANNELS (NORDIC)

Key squence	FISHING BOATS CH	Ship Transmit	Ship Recive	Application
	F1	155.625	155.625	Fishing boat F1
	F2	155.775	155.775	Fishing boat F2
	F3	155.825	155.825	Fishing boat F3

Key squence	PLEASURE BOATS CH	Ship Transmit	Ship Recive	Application
	L1	155.500	155.500	Pleasure craft L1
	L2	155.525	155.525	Pleasure craft L2
	L3	155.650	155.650	Pleasure craft L3

### PRIVATE CHANNELS (NETHERLANDS - INLAND)

Key squence		Ship Transmit	Ship Recive	Application
		157.550	162.150	Yacht harbor (CH31)

# Digital Interface (IEC 61162-1 Edition 2)

## Input sentences

GGA, GLL, RMA, RMC, ZDA

Schematic diagram

NMEA

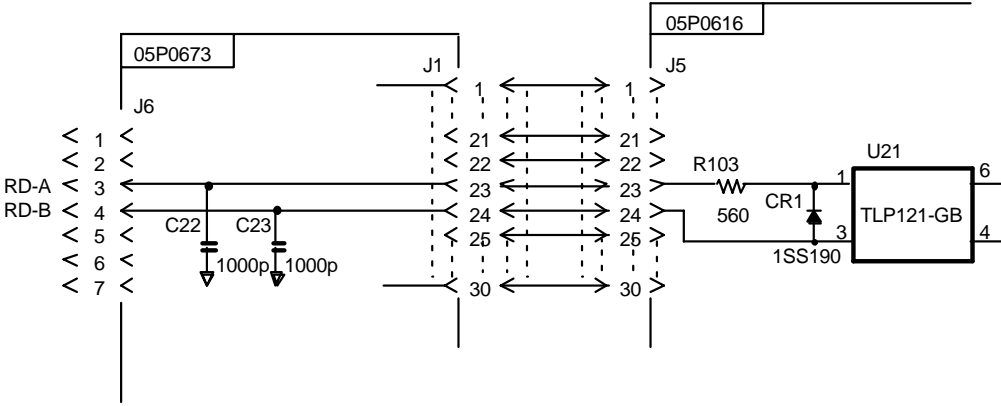

## Load requirements as listner

Isolation	Optocoupler
Input impedance	560 ohms
Max. Voltage	± 15V
Threshold	4 mA

## GGA - Global positioning system (GPS) fix data

\$--GGA,hhmmss.ss,lll.lll,a,yyyyy.yyy,a,x,xx,x.x,x.x,M,x.x,M,x.x,xxxx\*hh<CR><LF>

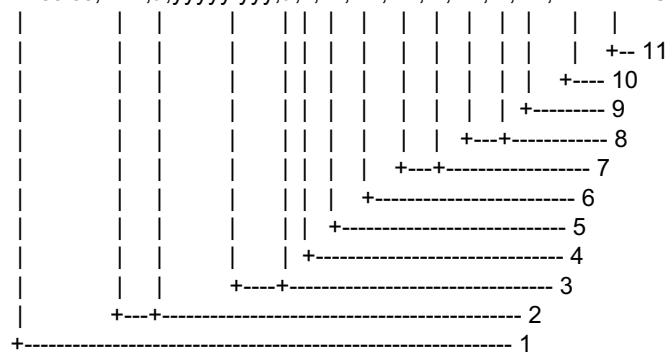

1. UTC of position
2. Latitude, N/S
3. Longitude, E/W
4. GPS quality indicator (see note)
5. Number of satellite in use,00-12, may be different from the number in view
6. Horizontal dilution of precision
7. Antenna altitude above/below mean sealevel, m
8. Geoidal separation, m
9. Age of differential GPS data
10. Differential reference station ID, 0000-1023
11. Checksum

### NOTE

- 0 = fix not available or invalid
- 1 = GPS SPS mode, fix valid
- 2 = differential GPS, SPS mode, fix valid
- 3 = GPS PPS mode, fix valid
- 4 = Real Time Kinetic. Satellite system used in RTK mode with fixed integers
- 5 = Float RTK. Satellite system used in RTK mode with floating fingers
- 6 = Estimated (dead reckoning) mode
- 7 = Manual input mode
- 8 = Simulator mode

The GPS quality indicator shall not be a null field.



## GLL - Geographic position - latitude and longitude

\$--GLL,III.III,a,yyyyy.yyy,a,hmmss.ss,A,a\*hh<CR><LF>

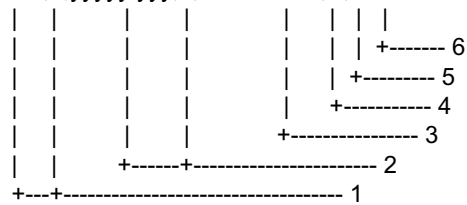

1. Latitude, N/S
2. Longitude, E/W
3. UTC of position
4. Status: A=data valid, V=data invalid
5. Mode indicator(see note)
6. Checksum

NOTE Positioning system Mode indicator:

- A = Autonomous
- D = Differential
- E = Estimated (dead reckoning)
- M = Manual input
- S = Simulator
- N = Data not valid

The Mode indicator field supplements the Status field. The Status field shall be set to V=invalid for all values of Operating Mode except for A=Autonomous and D=Differential. The positioning system Mode indicator and Status field shall not be null fields.

## RMA - Recommended minimum navigation information - Loran C data

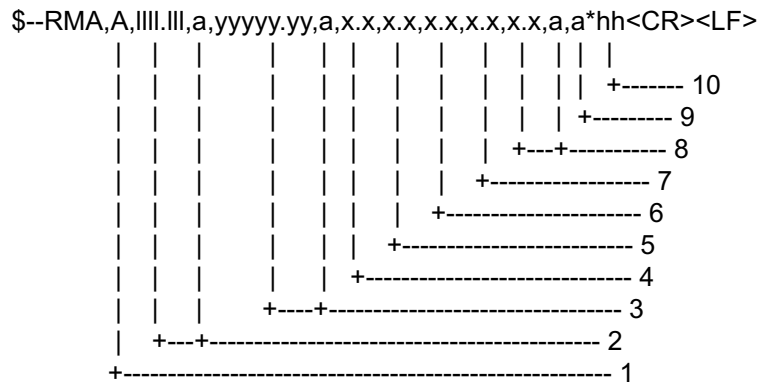

1. Status: A=data valid, V=blink, cycle or SNR warning
2. Latitude, degrees N/S
3. Longitude, degrees E/W
4. Time difference A, microseconds
5. Time difference B, microseconds
6. Speed over ground, knots
7. Course over ground, degrees true
8. Magnetic variation(see note 1),degree E/W
9. Mode indicator(see note 2)
10. Checksum

NOTE 1 - Easterly variation(E) subtracts from true course  
 Westerly variation(W) adds to true course

NOTE 2 Positioning system Mode indicator:  
 A = Autonomous  
 D = Differential  
 E = Estimated (dead reckoning)  
 M = Manual input  
 S = Simulator  
 N = Data not valid

The Mode indicator field supplements the Status field. The Status field shall be set to V=invalid for all values of Operating Mode except for A=Autonomous and D=Differential. The positioning system Mode indicator and Status field shall not be null fields.

## RMC - Recommended minimum specific GPS/TRANSIT data

\$--RMC,hhmmss.ss,A,lll.lll,a,yyyyy.yyy,a,x.x,x.x,xxxxx,x.x,a,\*hh<CR><LF>

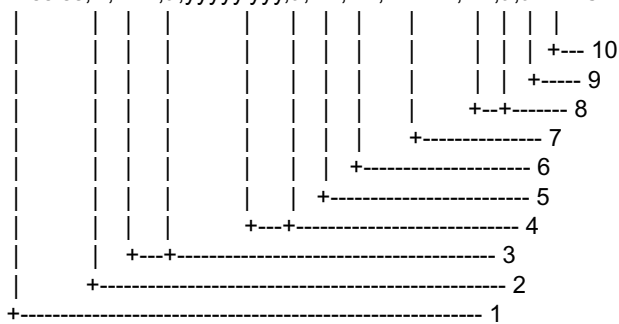

1. UTC of position fix
2. Status: A=data valid, V=navigation receiver warning
3. Latitude, N/S
4. Longitude, E/W
5. Speed over ground, knots
6. Course over ground, degrees true
7. Date: dd/mm/yy
8. magnetic variation, degrees E/W
9. Mode indicator(see note)
10. Checksum

NOTE Positioning system Mode indicator:

- A = Autonomous
- D = Differential
- E = Estimated (dead reckoning)
- M = Manual input
- S = Simulator
- N = Data not valid

The Mode indicator field supplements the Status field. The Status field shall be set to V=invalid for all values of Operating Mode except for A=Autonomous and D=Differential. The positioning system Mode indicator and Status field shall not be null fields.

## ZDA – Time and date

\$--ZDA,hhmmss.ss,xx,xx,xxxx,xx,xx,\*hh<CR><LF>

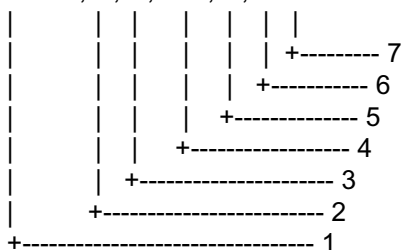

1. UTC
2. Day, 01 to 31(UTC)
3. Month, 01 to 12(UTC)
4. Year(UTC)
5. Local zone hours, 00h to +-13h
6. Local zone minutes, 00 to +59  
as local hours
7. Checksum

This page is intentionally left blank.

# INDEX

---

## A

ACK RQ 4-5  
Alarm Setup 6-5  
All Ships Call 4-9  
Auto Acknowledge 2-7

## C

Calling type 5-1  
CH16 1-4  
channel mode 1-3

## D

diagnostic test 8-2  
DIST ACK signal 3-6  
Distress Alert 3-1  
distress alert 3-5  
Distress Alert Relay 3-9  
Distress call 3-2  
DSC message 2-5  
Dual Watch 1-5

## I

Individual Call 4-1

## L

LED Warnings 2-1  
Loudspeaker 1-4

## N

Nature of Distress 3-1

## O

Opening a file 4-19  
operating function 1-3  
Other Station ID 5-7  
Output Power 1-4, 7-5  
Own Ship Position 3-3  
Own Ship's ID 7-1

## P

position 3-3  
PPT (Press-to-talk) 1-4  
prepare transmit message 4-16  
Printer setup 6-1  
Priority 1-6

## R

receive message 4-22  
retrieved message 4-21  
ROM Version 7-2

## S

Saving Message 4-16  
Scanning 1-5  
squelch 1-3  
Standby display 2-4

## T

telephone call 5-3  
Telephone Number 5-7  
Time-out Timer 1-6  
transmit message 4-20  
Transmitting a file 4-19  
Tx output power 7-5

## V

VHF Section Setting 7-3

# FURUNO®

**FURUNO ELECTRIC CO., LTD.**

9-52 Ashihara-Cho, Nishinomiya City, 662-8580, Hyogo, Japan

Tel: +81 798-65-2111 Fax: +81 798-65-4200

Pub NO. DOC-468

## Declaration of conformity

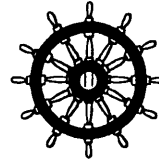

# 0560

We **FURUNO ELECTRIC CO., LTD.**

(Manufacturer)

9-52 Ashihara-Cho, Nishinomiya City, 662-8580, Hyogo, Japan

(Address)

hereby declare under our sole responsibility that the product

VHF radio telephone with DSC model FM-8700 and its ancillary equipment: Duplexer unit DX-8700, Printer interface IF-8500, Remote station RB-700, Distribution box DB-500, Printer PP-510, AC powersupply PR-300 and Distress message controller DMC-5

(Model names, type numbers)

to which this declaration relates conforms to the following standard(s) or normative document(s)

Standards

IMO Resolution MSC.36(63)

IMO Resolutions A.385(X), A.524(13)

IMO Resolutions A.803(19), MSC.68(68) A.1

IMO Resolution A.694(17)

MSC Circular MSC/Circ.862

Test standards

ETS 300 162: 1998-03

ETS 300 338: 1995-11

EN 60945: 1997-01 (IEC 60945 Ed.03: 1996-11)

IEC 61162-1: 2000-07

ITU-R Recommendations M.489-2, M.493-9, M.541-8, M.689-2

(title and/or number and date of issue of the standard(s) or other normative document(s))

For assessment, see

- EC type-examination certificate N°: 99212006/AA/01 of 14 May 2002 issued by Telefication, The Netherlands
- Test reports 97360630, 97360631 and 67360632 of 6 March 1998 issued by KTL, The Netherlands

This declaration is issued according to the provisions of European Council Directive 96/98/EC on marine equipment modified by Commission Directive 2001/53/EC.

On behalf of Furuno Electric Co., Ltd.

Hiroaki Komatsu  
Manager,  
International Rules and RegulationsNishinomiya City, Japan  
June 17, 2002

(Place and date of issue)

(name and signature or equivalent marking of authorized person)