



32" LCD TV

DX-32L100A13

USER GUIDE

Dynex DX-32L100A13

32" LCD TV

Contents

CHILD SAFETY	1
Important Safety Instructions	2
Warning	2
Caution	3
Installing the stand or wall-mount bracket	4
Installing the stand	4
Installing a wall-mount bracket	4
TV components	4
Package contents	4
Front	5
Back and Side	5
Remote control 1	6
Remote control 2	7
Making connections	8
What connection should I use?	8
Connecting power	9
Connecting a cable or satellite box	9
Connecting an antenna or cable TV (no box)	11
Connecting a DVD or Blu-ray player	12
Connecting a VCR	13
Connecting a camcorder or game console	14
Connecting a computer	14
Connecting a USB flash drive	15
Connecting headphones	16
Connecting a basic home theater system	16
Connecting a home theater system with multiple devices	17
Using the remote control	17
Installing remote control batteries	17
Aiming the remote control	17
Turning on your TV for the first time	18
Understanding the basics	19
Turning your TV on or off	19
Selecting the video input source	19
Using the on-screen menus	19
Navigating the menus	20
Selecting a channel	20
Adjusting the volume	20
Viewing program information	20
Adjusting the picture	20
Adjusting the TV picture	20
Adjusting the computer image	22
Adjusting the sound	22
Adjusting sound settings	22
Playing TV audio only	22
Changing channel settings	23
Automatically scanning for channels	23
Hiding channels	23
Setting up a favorite channel list	24

Viewing a favorite channel	24
Adding or changing a channel label	24
Checking the digital signal strength	25
Setting parental controls	25
Setting or changing the password	25
Locking control buttons	26
Setting parental control levels	26
Downloading rating information	27
Using closed captioning	28
Turning closed captioning on or off	28
Selecting the analog closed captioning mode	28
Customizing digital closed captioning styles	29
Adjusting time settings	30
Setting the clock	30
Setting the sleep timer	30
Adjusting menu settings	31
Selecting the menu language	31
Labeling an input source	31
Restoring settings to default	32
Using a USB flash drive	32
Switching to USB mode	32
Browsing photos	32
Viewing your favorite photos	33
Viewing photos in a slideshow	33
Customizing slideshow settings	34
Maintaining	34
Cleaning	34
Servicing	35
Troubleshooting	35
Video and audio	35
Remote control	36
General	36
Specifications	37
Programming universal remote controls	38
Programming a different universal remote control	38
For additional help and information... ..	38
Common universal remote control codes	39
Legal notices	39
One-year limited warranty - Dynex Televisions	41
Definitions:	41
How long does the coverage last?	41
What does this warranty cover?	41
How to obtain warranty service?	41
Where is the warranty valid?	41
What does the warranty not cover?	41

CHILD SAFETY

It makes a difference how and where you use your flat panel display

As you enjoy your new product, keep these safety tips in mind

The issue

The home theater entertainment experience is a growing trend, and larger TVs are popular purchases. However, TVs are not always supported on the proper stands or installed according to the manufacturer's recommendations. We and the consumer electronics industry are committed to making home entertainment enjoyable and safe.

TVs that are inappropriately placed on dressers, bookcases, shelves, desks, speakers, chests, or carts may fall over and cause injury.

Tune into safety

- One size of TV stand does **not** fit all. Use only a TV stand rated for the weight of your TV.
- Carefully read and understand all enclosed instructions for proper use of this product.
- Don't let children climb on or play with entertainment system furniture and TVs.
- Don't place TVs on furniture that can easily be used as steps, such as a crate or chest of drawers.
- Remember that children can become excited while watching a program, especially on a "larger-than-life" TV. Make sure that you place or install the TV where it cannot be pushed, pulled over, or knocked down.
- Make sure that you route all cords and cables so that they cannot be pulled or grabbed by curious children.



Wall mounting

If you decide to wall mount your TV, always remember:

- One size of wall mount does **not** fit all. Use only a wall mount rated for the weight of your TV and that has been recommended by this TV manufacturer, listed in this manual, or otherwise listed by an independent laboratory as suitable for your TV.
- Follow all instructions supplied by the TV and wall mount manufacturers.
- If you have any doubts about your ability to safely wall mount your TV, get help from a professional installer.
- Make sure that the wall where you are mounting the TV is appropriate. Some wall mounts are not designed to be mounted to walls backed with steel studs or cinder blocks. If you are unsure, ask a professional installer.
- TVs can be heavy. At least two people are required for safe wall mount installation.



Important Safety Instructions



This symbol indicates that dangerous voltage constituting a risk of electric shock is present within your TV. This label is located on the back of your TV.



This symbol indicates that there are important operating and maintenance instructions in the literature accompanying your TV.

- 1 Read these instructions.
- 2 Keep these instructions.
- 3 Heed all warnings.
- 4 Follow all instructions.
- 5 Do not use this apparatus near water.
- 6 Clean only with dry cloth.
- 7 Do not block any ventilation openings. Install in accordance with the manufacturer's instructions.
- 8 Do not install near any heat sources such as radiators, heat registers, stoves, or other apparatus (including amplifiers) that produce heat.
- 9 Do not defeat the safety purpose of the polarized or grounding-type plug. A polarized plug has two blades with one wider than the other. A grounding type plug has two blades and a third grounding prong. The wide blade or the third prong are provided for your safety. If the provided plug does not fit into your outlet, consult an electrician for replacement of the obsolete outlet.
- 10 Protect the power cord from being walked on or pinched particularly at plugs, convenience receptacles, and the point where they exit from the apparatus.
- 11 Only use attachments/accessories specified by the manufacturer.
- 12 Use only with the cart, stand, tripod, bracket, or table specified by the manufacturer, or sold with the apparatus. When a cart is used, use caution when moving the cart/apparatus combination to avoid injury from tip-over.
- 13 Unplug this apparatus during lightning storms or when unused for long periods of time.
- 14 Refer all servicing to qualified service personnel. Servicing is required when the apparatus has been damaged in any way, such as power-supply cord or plug is damaged, liquid has been spilled or objects have fallen into the apparatus, the apparatus has been exposed to rain or moisture, does not operate normally, or has been dropped.
- 15 The *wall plug* is the disconnecting device. The plug must remain readily operable.
- 16 An apparatus with three-prong, grounding-type plug is a Class I apparatus which needs to be grounded to prevent possible electric shock. Make sure that you connect the Class I apparatus to a grounding-type, three-prong outlet.
- 17 Remote control batteries should not be exposed to excessive heat such as sunshine, fire, or the like.
- 18 The apparatus should not be exposed to dripping or splashing and no objects filled with liquids, such as vases, should be placed on the apparatus.



S3125A

Warning

Electric shock hazard

To reduce the risk of fire or electric shock, do not remove any cover or expose the device to rain or moisture. No user-serviceable parts are inside. Refer servicing to qualified service technicians.

Lightning

For added protection for your device receiver during a lightning storm, or when it is left unattended and unused for long periods of time, unplug it from the power outlet and disconnect any antenna or cable system. This helps prevent property damage and personal injury from lightning and power line surges.

Power lines

An outside antenna system should not be located in the vicinity of overhead power lines or other electric light or power circuits, or where it can fall into such power lines or circuits. When installing an outside antenna system, extreme care should be taken to keep from touching such power lines or circuits as contact with them might be fatal.

Handling the LCD panel

- Your TV's screen is made of glass. Do not drop your TV or hit, jolt, or press hard against the LCD panel. If the screen breaks, be careful of broken glass.
- If the LCD panel is broken, make absolutely sure that you do not touch the liquid in the panel. This may cause skin inflammation.
- If the liquid gets in your mouth, immediately gargle, rinse, and consult with your doctor. Also, if the liquid gets in your eyes or touches your skin, consult with your doctor after rinsing for at least 15 minutes or longer in clean water.

Replacement parts

When replacement parts are required, make sure that the service technician uses replacement parts specified by the manufacturer that have the same characteristics as the original part. Unauthorized substitutions may result in fire, electric shock, personal injury, or other hazards.

Safety check

After completing any service or repair to this device, ask the service technician to perform routine safety checks to determine that your TV is in correct operating condition.

Power source

Operate your TV only from the type of power source indicated on the marking label. If you are not sure of the type of power supplied to your home, consult an electrician or your local power company.

Servicing

These servicing instructions are for use by qualified service personnel only. To reduce the risk of electric shock, do not perform any servicing other than that contained in the operating instructions unless you are qualified to do so.

Caution

Damage requiring service

Unplug this TV from the power outlet and refer servicing to qualified service personnel under the following conditions:

- When the power supply cord or plug is damaged or frayed.
- If liquid has been spilled or objects have fallen into your TV.
- If your TV has been exposed to rain or water.
- If your TV does not operate normally by following the operating instructions. Adjust only those controls that are covered by the operating instructions because incorrect adjustment of other controls may result in damage and will often require extensive work by a qualified technician to restore your TV to its normal operation.
- If your TV has been dropped or damaged in any way.
- When your TV exhibits a distinct change in performance.

Outdoor antenna grounding

If an outside antenna or cable system is connected to your TV, make sure that the antenna or cable system is grounded to provide some protection against voltage surges and built-up static charges. Article 810 of the National Electrical Code, ANSI/NFPA No. 70, provides information with respect to correct grounding of the mast and supporting structure, grounding of the lead-in wire to an antenna discharge unit, size of grounding conductors, location of the antenna-discharge unit, connection to grounding electrodes, and requirements for the grounding electrode.

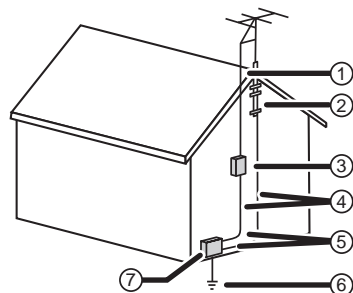

- ① Antenna lead-in wire
- ② Grounding clamp
- ③ Antenna discharge unit
- ④ Grounding conductors
- ⑤ Ground clamps
- ⑥ Power service grounding electrode system
- ⑦ Electric service equipment

Note to CATV system installer

Article 820 of the National Electrical Code, ANSI/NFPA No. 40 provides guidance for correct grounding. Specifically, it states that the cable ground must be connected to the grounding system of the building as close to the point of cable entry as practical.

Condensation

Moisture will form on the TV if the TV is brought from cool surroundings into a warm room or if the temperature of the room rises suddenly. When this happens, the TV's performance may be impaired. To prevent this, let the TV stand in its new surroundings for about an hour before switching it on, or make sure that the room temperature rises gradually.

Condensation may also form during the summer if the TV is exposed to the breeze from an air conditioner. In such cases, change the location of the TV.

Mobile telephone warning

To avoid interference with your TV picture and sound, operating problems, or even damage, keep your cordless and cellular telephones away from the TV.

End of life directives

Your TV contains tin-lead solder and a fluorescent lamp containing a small amount of mercury. Disposal of these materials may be regulated for environmental reasons. Your TV also contains material that can be recycled and reused. For disposal or recycling information, contact your local authorities to find a recycler in your area.

Non-active pixels

The LCD panel contains almost 3 million thin film transistors, which provide exceptionally sharp video quality. Occasionally, a few non-active pixels may appear on the screen as a fixed blue, green, or red point. These non-active pixels do not adversely affect the performance of your TV, and are not considered defects.

Installing the stand or wall-mount bracket

Notes

- If you plan to wall-mount your TV, do not install the stand.
- Store the stand and stand screws in case you decide to use the stand in the future.

Installing the stand

To install the stand:

- 1 Carefully place your TV screen face-down on a cushioned, clean surface to protect the screen from damages and scratches.

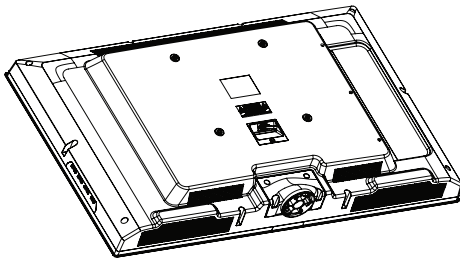

- 2 Secure the stand to the stand column on the TV with the six screws M4 type (16 mm) provided.

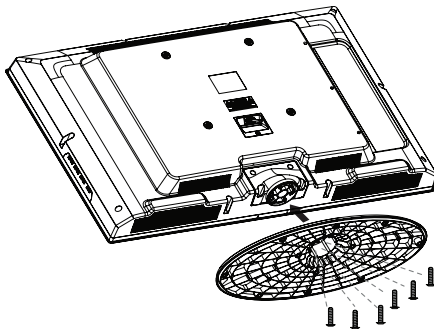

Installing a wall-mount bracket

Warning

This apparatus is intended to be supported by a UL Listed wall mount bracket.

To attach your TV to a wall-mount bracket:

- 1 Carefully place your TV screen face-down on a cushioned, clean surface to protect the screen from damages and scratches. If you don't need to remove the base (that is, if you are removing your TV from the box for the first time), skip to Step 3.
- 2 Remove the six screws that secure the base to the stand, then remove the base.

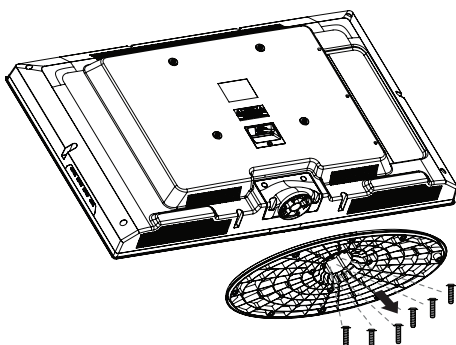

- 3 Attach the wall-mount bracket to your TV using the mounting holes on the back of your TV. See the instructions that came with the wall-mount bracket for information about how to correctly hang your TV.

Note

The length of the M5 wall-mount screws vary depending on the wall-mount bracket you purchased. See the instructions that came with the wall-mount bracket for screw lengths.

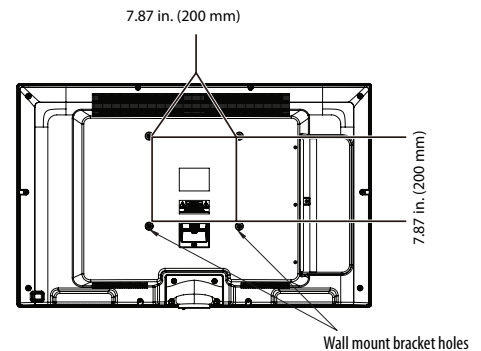

TV components

Package contents

- Remote control and batteries (2 AAA)
- Stand with screws
- *Quick Setup Guide*
- *Important Information*

Front

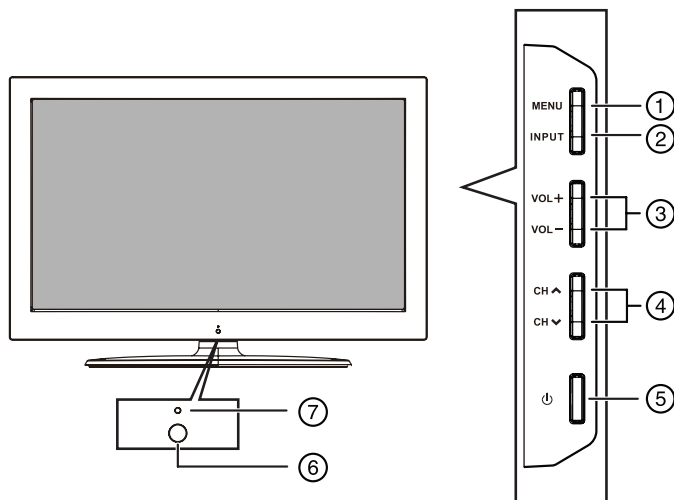

#	Item	Description
①	MENU	Press to open the on-screen menu. For more information, see “Navigating the menus” on page 20.
②	INPUT	Press to open the <i>INPUT SOURCE</i> list, then press CH ^ or CH v to select a video input source. For more information, see “Selecting the video input source” on page 19.
③	VOL+/VOL-	Press to increase or decrease the volume.
④	CH ^/CH v	Press to go to the next or previous channel in the channel list.
⑤	⏻ (Power)	Press to turn your TV on or off (standby mode). When your TV is in standby mode, power still flows through it. To completely disconnect power, unplug the power cord.
⑥	Remote sensor	Receives the signals from the remote control. Do not block.
⑦	Power indicator	Turns off when your TV is turned on. Lights red when your TV is in standby mode. For more information, see “Turning your TV on or off” on page 19.

Back and Side

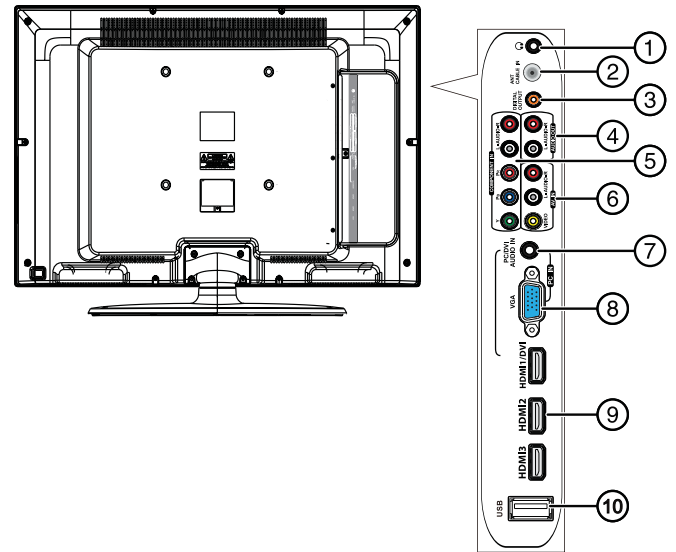

#	Item	Description
①	🎧 (headphone)	Connect headphones to this jack. For more information, see “Connecting headphones” on page 16.
②	ANT CABLE IN	Connect an antenna or cable TV to this jack. For more information, see “Connecting an antenna or cable TV (no box)” on page 11.
③	DIGITAL OUTPUT	Connect a digital sound system to this jack. For more information, see “Connecting a basic home theater system” on page 16.
④	ANALOG AUDIO OUT	Connect an audio amplifier to these jacks. For more information, see “Connecting a basic home theater system” on page 16.
⑤	COMPONENT IN Y, Pb, Pr	Connect the video for a component video device to these jacks. For more information, see “Using component video (better)” on page 10.
⑥	AV IN	Connect the audio (L and R) and video for a composite video device, such as a VCR, to these jacks. For more information, see “Using composite video (good)” on page 11.
⑦	PC/DVI AUDIO IN	Connect the audio for a computer or a DVI device to this jack. For more information, see “Connecting a computer” on page 14, or “Using DVI (same as HDMI but requires an audio connection)” on page 10.
⑧	VGA/PC INPUT	Connect the video for a computer to this jack. For more information, see “Connecting a computer” on page 14.
⑨	HDMI1/HDMI2/HDMI3	Connect HDMI devices to these jacks. An HDMI cable carries both video and sound. You do not need to make an audio connection for an HDMI device. For more information, see “Connecting a DVD or Blu-ray player” on page 12, or “Using HDMI” on page 12.
⑩	USB	Connect a USB flash drive to this port. For more information, see “Connecting a USB flash drive” on page 15.

Remote control 1

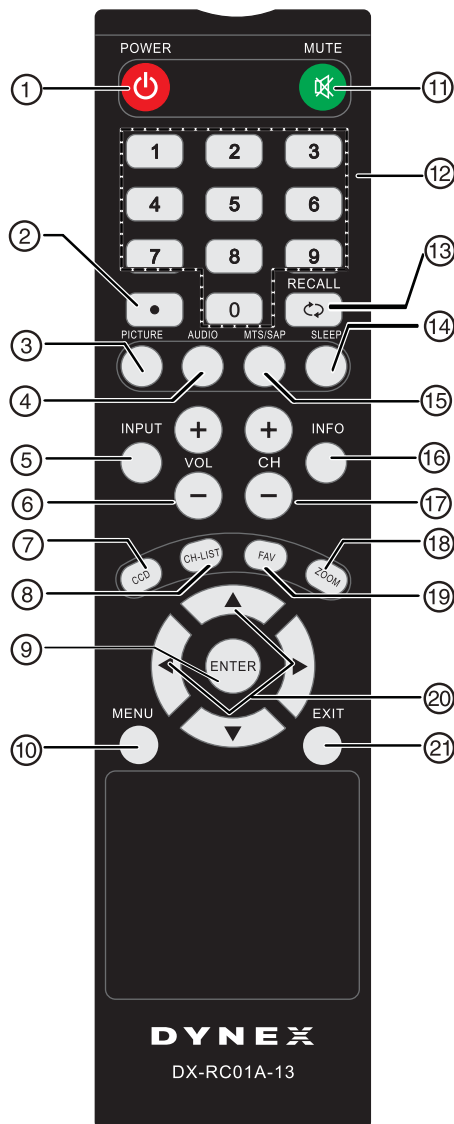

#	Button	Description
⑦	CCD	Press to turn closed captioning on or off. You can select On , Off , or CC On When Mute . For more information, see " Turning closed captioning on or off " on page 28.
⑧	CH-LIST	Press to open the channel list.
⑨	ENTER	Press to confirm selections or changes.
⑩	MENU	Press to open the on-screen menu.
⑪	⊗ MUTE	Press to mute the sound. Press again to restore the sound.
⑫	Numbers	Press to enter channel numbers and the parental control password.
⑬	RECALL	Press to go to the last viewed channel.
⑭	SLEEP	Press to set the sleep timer. For more information, see " Setting the sleep timer " on page 30.
⑮	MTS/SAP	In analog TV mode, press to select Stereo , Mono , or SAP . For more information, see " Adjusting sound settings " on page 22.
⑯	INFO	Press to display TV status information, such as the channel number, channel name (if available), or signal source. For more information, see " Viewing program information " on page 20.
⑰	CH+ / CH-	Press to go to the next or previous channel in the channel list. For more information, see " Selecting a channel " on page 20.
⑱	ZOOM	Press to select the aspect ratio. For more information, see " Adjusting the TV picture " on page 20.
⑲	FAV	Press to open the <i>Favorites</i> channel list. For more information, see " Setting up a favorite channel list " on page 24 and " Viewing a favorite channel " on page 24.
⑳	▲ ▼ ◀ ▶	Press to navigate through the on-screen menus and adjust settings.
㉑	EXIT	Press to close the on-screen menu.

#	Button	Description
①	⏻ (Power)	Press to turn your TV on or off (Standby mode). When your TV is off, power still flows into it. To disconnect power, unplug the power cord.
②	• (Dot)	Press to enter a digital sub-channel number. For more information, see " Selecting a channel " on page 20.
③	PICTURE	Press to select the picture mode. You can select Vivid , Standard , Energy Savings , or Custom . For more information, see " Adjusting the TV picture " on page 20.
④	AUDIO	Press to select an audio mode. For more information, see " Adjusting sound settings " on page 22.
⑤	INPUT	Press to open the <i>INPUT SOURCE</i> list, then press ▲ or ▼ to select a video input source. For more information, see " Selecting the video input source " on page 19.
⑥	VOL+/VOL-	Press to increase or decrease the volume.

Remote control 2

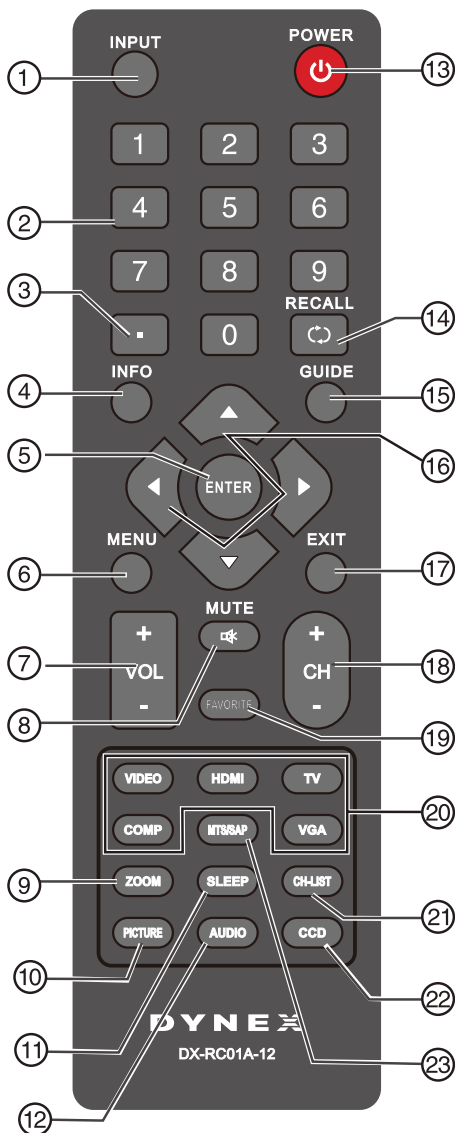

#	Button	Description
①	INPUT	Press to open the <i>INPUT SOURCE</i> list, then press ▲ or ▼ to select a video input source. For more information, see “ Selecting the video input source ” on page 19.
②	Numbers	Press to enter channel numbers and the parental control password.
③	• (Dot)	Press to enter a digital sub-channel number. For more information, see “ Selecting a channel ” on page 20.
④	INFO	Press to display TV status information, such as the channel number, channel name (if available), or signal source. For more information, see “ Viewing program information ” on page 20.
⑤	ENTER	Press to confirm selections or changes.
⑥	MENU	Press to open the on-screen menu.
⑦	VOL+/VOL-	Press to increase or decrease the volume.
⑧	⊘ MUTE	Press to mute the sound. Press again to restore the sound.









#	Button	Description
⑨	ZOOM	Press to select the aspect ratio. For more information, see “ Adjusting the TV picture ” on page 20.
⑩	PICTURE	Press to select the picture mode. You can select Vivid , Standard , Energy Savings , or Custom . For more information, see “ Adjusting the TV picture ” on page 20.
⑪	SLEEP	Press to set the sleep timer. For more information, see “ Setting the sleep timer ” on page 30.
⑫	AUDIO	Press to select an audio mode. For more information, see “ Adjusting sound settings ” on page 22.
⑬	⏻ (Power)	Press to turn your TV on or off (Standby mode). When your TV is off, power still flows into it. To disconnect power, unplug the power cord.
⑭	RECALL	Press to go to the last viewed channel.
⑮	GUIDE	This function is not available on this model.
⑯	▲ ▼ ◀ ▶	Press to navigate through the on-screen menus and adjust settings.
⑰	EXIT	Press to close the on-screen menu.
⑱	CH+ / CH-	Press to go to the next or previous channel in the channel list. For more information, see “ Selecting a channel ” on page 20.
⑲	FAVORITE	Press to open the <i>Favorites</i> channel list. For more information, see “ Setting up a favorite channel list ” on page 24 and “ Viewing a favorite channel ” on page 24.
⑳	Video Input	Press to select the input source. <ul style="list-style-type: none"> Press TV to select TV. Press COMP to select the device connected to the COMPONENT IN video jacks. Press VIDEO to select the device connected to the AV IN jacks. Press VGA to select the device connected to the PC IN VGA jack. Press HDMI once to select HDMI1, twice to select HDMI2, and three times to select a device connected to an HDMI3 jack.
㉑	CH-LIST	Press to open the channel list.
㉒	CCD	Press to turn closed captioning on or off. You can select On , Off , or CC On When Mute . For more information, see “ Turning closed captioning on or off ” on page 28.
㉓	MTS/SAP	In analog TV mode, press to select Stereo , Mono , or SAP . For more information, see “ Adjusting sound settings ” on page 22.

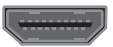

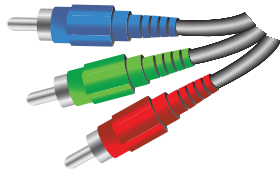

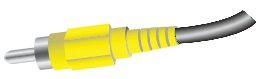
Making connections

What connection should I use?

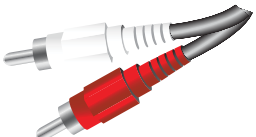
Your TV has several connection types for connecting devices to your TV. For the best video quality, you should connect a device to the best available connection.

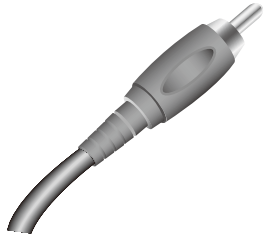
Use the following tables to identify cables:

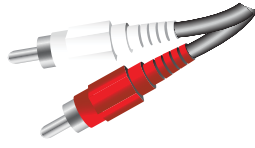
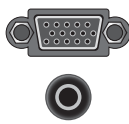
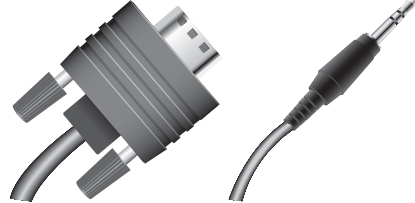
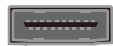
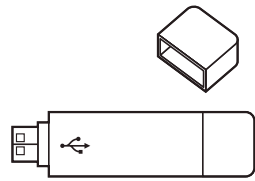
Connection type and jack	Video quality	Cable connector
 HDMI video/audio	Best (use this if your devices have HDMI)	
 Component video (requires an audio connection)	Better than composite, or coaxial	
 Composite video (requires an audio connection)	Better than coaxial	
 Coaxial video/audio	Good	
 Audio out	N/A	

Connection type and jack	Cable connectors
Digital coaxial audio 	
Analog audio 	
VGA (computer) video and audio 	
USB 	
Earphone 	

You can use the HDMI jack to connect a DVI device to your TV. You need to attach an HDMI-to-DVI adapter to the end of the HDMI cable that connects to the DVI device.

Cautions

- Check the jacks for position and type before making any connections.
- Loose connections can result in image or color problems. Make sure that all connections are tight and secure.
- The external audio/video equipment shown may be different from your equipment. If you have questions, refer to the documentation that came with your equipment.
- Always unplug the power cord when connecting external equipment.

Connecting power

To connect the power:

- Plug the AC power cord into an AC power outlet.

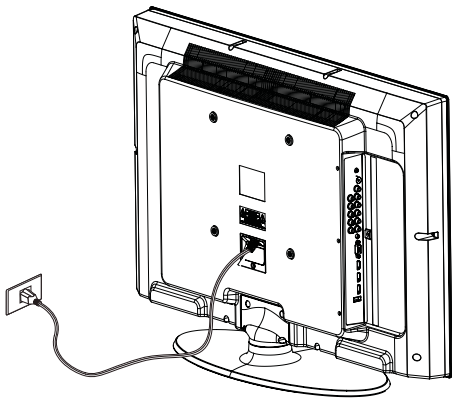

Notes

- Your TV should only be operated from the power source indicated on the label.
- Always unplug the AC power cord from the power outlet when you will not be using your TV for an extended period of time.
- The AC power cord is permanently attached to the back of your TV. Do not try to pull it out.

Connecting a cable or satellite box

Many cable or satellite TV boxes have more than one connection type. To get the best video, you should use the best connection type available. For more information, see “[What connection should I use?](#)” on page 8.

Notes

- If the signal level for a channel is weak, the picture may be distorted. Adjust the antenna or use a highly directional outdoor or set-top antenna with a built-in amplifier.
- If the picture quality is good on some channels and poor on others, the problem may be caused by a poor or weak signal from the broadcaster or cable TV provider.
- If you connect to cable or satellite TV without a set-top box and experience poor picture quality, you may need to install a set-top box to improve signal reception and picture quality. Contact your cable or satellite TV provider about upgrading to a set-top box.
- Many high-definition (HD) channels upscale standard-definition (SD) content. The picture displayed on your TV is still displayed as SD, thus the picture quality will not be as clear or crisp as it would be if the content was originally recorded in HD.

Using HDMI (best)

To connect a cable or satellite box using HDMI:

- 1 Turn off your TV and all connected equipment.
- 2 Connect the incoming cable from the cable wall jack to the cable-in jack on the cable or satellite box.
- 3 Connect an HDMI cable (not provided) to one of the HDMI jacks on the side of your TV and to the **HDMI OUT** jack on the cable or satellite box.

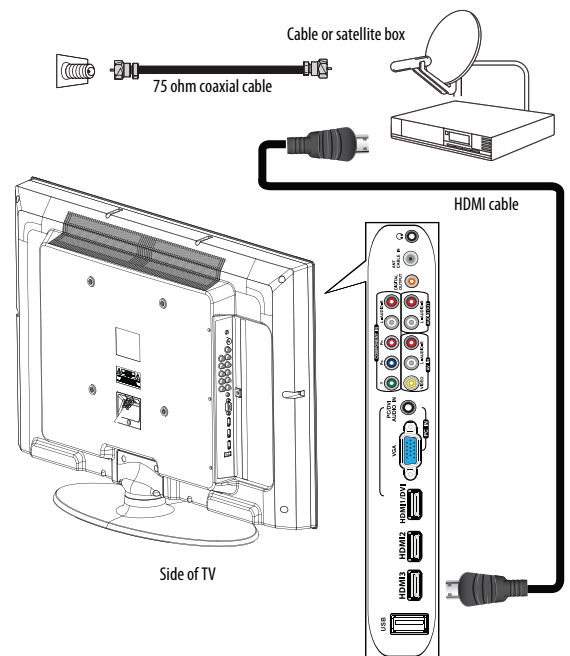

- 4 Turn on your TV, then turn on the cable or satellite box.

Note

An HDMI cable carries both audio and video. You do not need to use any audio cables.

Using DVI (same as HDMI but requires an audio connection)

Note

A DVI device must be connected to the **HDMI1** jack. If you connect a DVI device to another HDMI jack, you will not hear any audio.

To connect a cable or satellite box using DVI:

- 1 Turn off your TV and all connected equipment.
- 2 Connect the incoming cable from the cable wall jack to the cable-in jack on the cable or satellite box.
- 3 Connect an HDMI-DVI adapter (not provided) to one end of an HDMI cable (not provided), then connect it to the **DVI OUT** jack on the cable or satellite box.
- 4 Connect the other end of the HDMI cable to the **HDMI1** jack on the side of your TV.

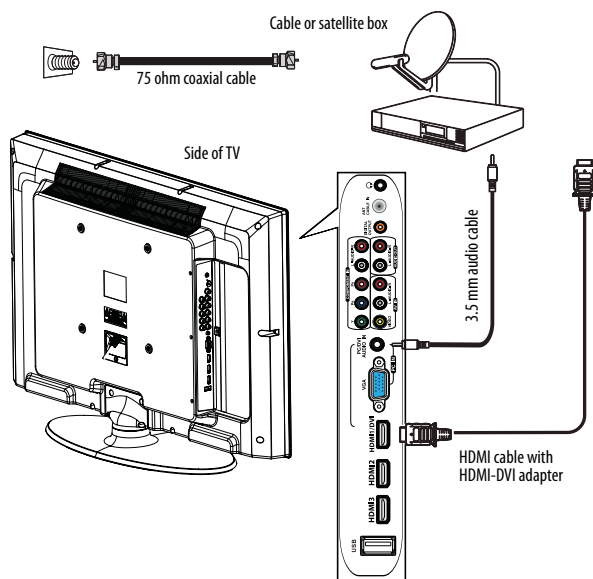

- 5 Connect a 3.5 mm audio cable (not provided) to the **PC AUDIO IN** jack on the back of your TV and to the **AUDIO OUT** jack on the cable or satellite box.
- 6 Turn on your TV, then turn on the cable or satellite box.

Using component video (better)

To connect a cable or satellite box using component video:

- 1 Turn off your TV and all connected equipment.
- 2 Connect the incoming cable from the cable wall jack to the cable-in jack on the cable or satellite box.
- 3 Connect a component video cable (not provided) to the **COMPONENT IN/Y, PB, PR** jacks on the side of your TV and to the component video out jacks on the cable or satellite box.

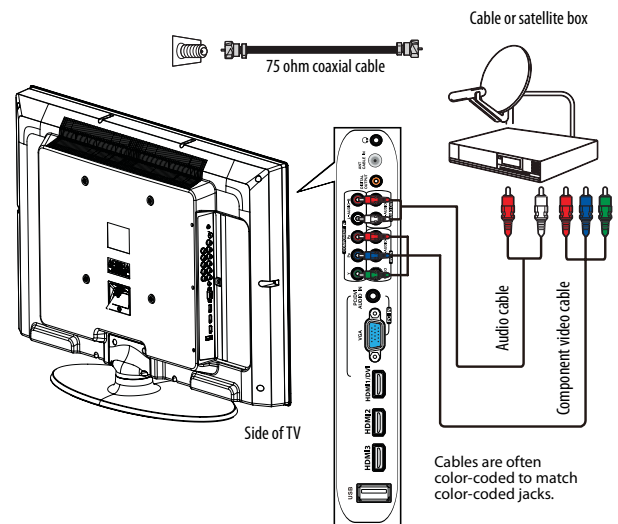

Cables are often color-coded to match color-coded jacks.

- 4 Connect an audio cable (provided) to the **L** and **R** audio jacks on the side of your TV and to the audio out jack on the cable or satellite TV box.

Note

When you connect the audio using the **L** and **R** audio jacks, the audio output is analog. If your TV has a digital audio jack (optical or coaxial), you can connect the video to the component video jacks, then connect a digital audio cable to receive digital audio.

- 5 Turn on your TV, then turn on the cable or satellite box.

Using composite video (good)

To connect a cable or satellite box using composite video:

- 1 Turn off your TV and all connected equipment.
- 2 Connect the incoming cable from the cable wall jack to the cable-in jack on the cable or satellite box.
- 3 Connect a composite (A/V) cable (not provided) to the **VIDEO IN** jack and **L/R AUDIO** jacks on the side of your TV and to the composite video and audio out jacks on the cable or satellite box.

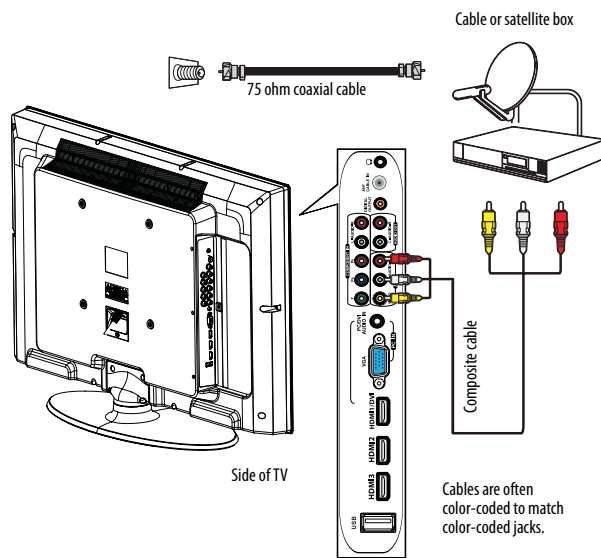

- 4 Turn on your TV, then turn on the cable or satellite box.

Connecting an antenna or cable TV (no box)

To connect an antenna or cable TV (no box):

- 1 Turn off your TV and all connected equipment.
- 2 Connect a coaxial cable (not provided) to the **ANT/CABLE IN** jack on the side of your TV and to the antenna or cable TV wall jack.

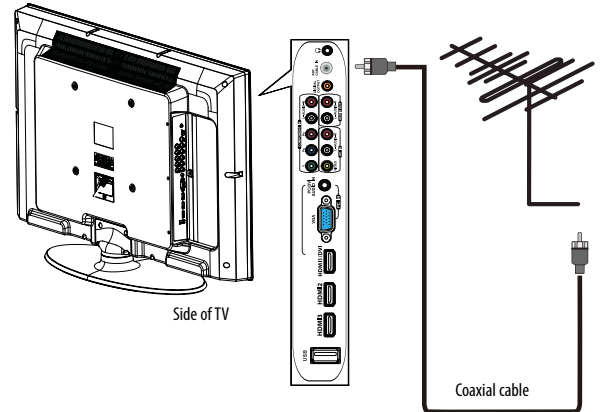

- 3 Turn on your TV.

Notes

- Use a coaxial cable to eliminate interference and noise from radio waves.
- Do not bundle the coaxial cable with the power cord or other cables.
- If the antenna is not installed correctly, contact qualified service personnel to correct the problem.

Connecting a DVD or Blu-ray player

Using HDMI

To connect a DVD or Blu-ray player using HDMI:

- 1 Make sure that your TV's power cord is unplugged and the DVD or Blu-ray player is turned off.
- 2 Connect an HDMI cable (not provided) to one of the **HDMI** jacks on the side of your TV and to the **HDMI OUT** jack on the DVD or Blu-ray player.

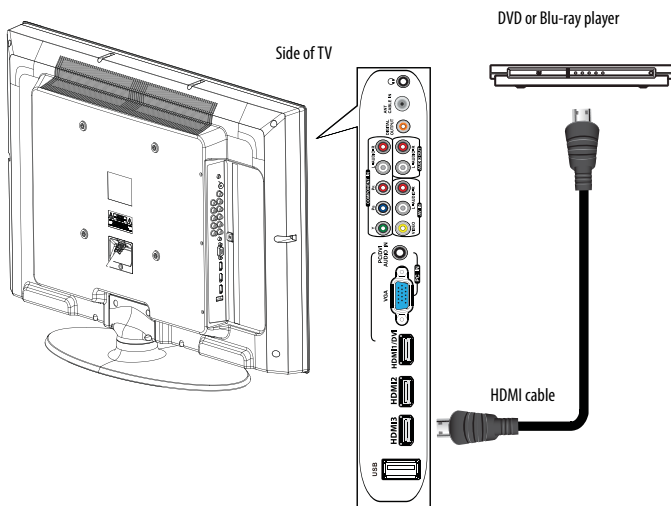

To play from a DVD or Blu-ray player:

- 1 Turn on your TV, then press **INPUT** to open the **INPUT SOURCE** list.
- 2 Press **▲** or **▼** to select **HDMI1**, **HDMI2**, or **HDMI3**, then press **ENTER**.

Note

You can also press **HDMI** one or more times to select **HDMI1**, **HDMI2**, or **HDMI3**.

- 3 Turn on the DVD or Blu-ray player.

Using component video (better)

To connect a DVD or Blu-ray player using component video:

- 1 Make sure that your TV's power cord is unplugged and the component video device is turned off.
- 2 Connect a component video cable (not provided) to the **COMPONENT IN/Y, PB, PR** jacks on the side of your TV and to the **COMPONENT OUT** jacks on the component video device.

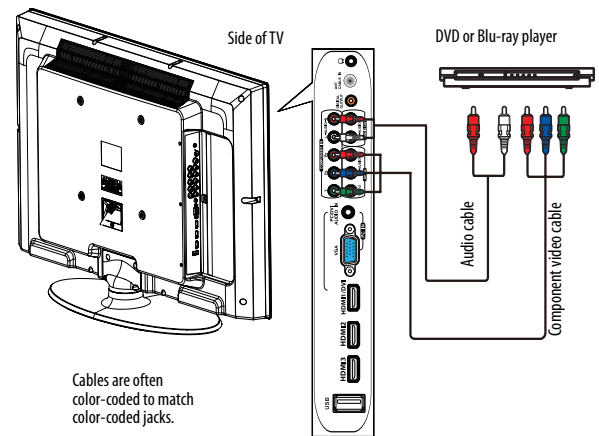

Cables are often color-coded to match color-coded jacks.

- 3 Connect an audio cable (not provided) to the **L** and **R** (audio in) jacks on the side of your TV and to the **L/R AUDIO OUT** jacks on the component video device.

Note

When you connect the audio using the **L** and **R** audio jacks, the audio output is analog.

If your TV has a digital audio jack (optical or coaxial), you can connect the video and audio to the component video and L/R audio jacks, then you can get digital audio output from the digital audio jack.

To play from the component video device:

- 1 Turn on your TV, then press **INPUT** to open the **INPUT SOURCE** list.
- 2 Press **▲** or **▼** to select **Component**, then press **ENTER**.

Note

You can also press **COMP** to select the component video device.

- 3 Turn on the DVD or Blu-ray player.

Using composite video (good)

To connect a DVD or Blu-ray player using composite video:

- 1 Make sure that your TV's power cord is unplugged and the composite video device is turned off.
- 2 Connect a composite cable (provided) to the **VIDEO** and **L** and **R** (audio in) jacks on the side of your TV and to the **AV OUT** jacks on the composite video device.

Note

When you connect the audio using the **L** and **R** audio jacks, the audio output is analog.

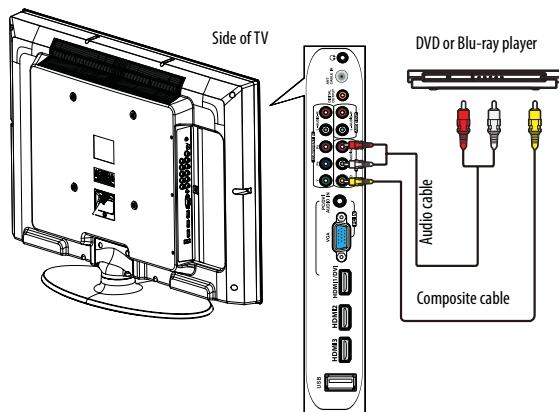

Cables are often color-coded to match color-coded jacks. Connect yellow to yellow, red to red, and white to white.

Connecting a VCR

To connect a VCR:

- 1 Make sure that your TV's power cord is unplugged and the VCR is turned off.
- 2 Connect a composite cable (provided) to the **VIDEO** and **L** and **R** (audio in) jacks on the side of your TV and to the **AV OUT** jacks on the VCR.

Note

When you connect the audio using the **L** and **R** audio jacks, the audio output is analog.

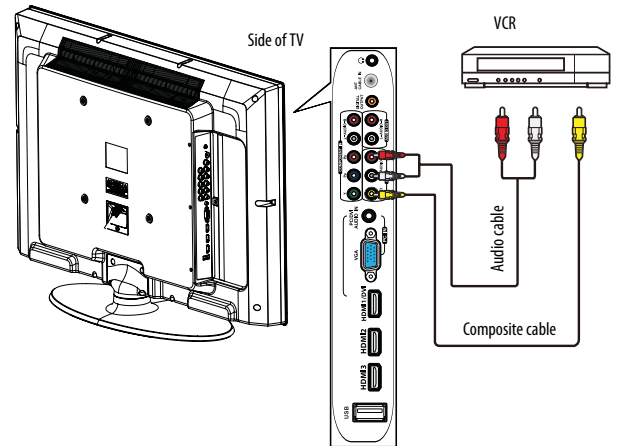

Cables are often color-coded to match color-coded jacks. Connect yellow to yellow, red to red, and white to white.

To play from the composite video device:

- 1 Turn on your TV, then press **INPUT** to open the *INPUT SOURCE* list.
- 2 Press **▲** or **▼** to select **AV**, then press **ENTER**.

Note

- You can also press **VIDEO** to select the composite device.
- If you are not using the included audio cable for another device, you can use it and a standard one-plug video cable instead of the three-plug cable shown in this task.

- 3 Turn on the DVD or Blu-ray player.

To play from the VCR:

- 1 Turn on your TV and the VCR, then press **INPUT** to open the *INPUT SOURCE* list.
- 2 Press **▲** or **▼** to select **AV**, then press **ENTER**.

Note

You can also press **VIDEO** to select the VCR.

Connecting a camcorder or game console

To connect a camcorder or game console:

- 1 Make sure that your TV's power cord is unplugged and the camcorder or game console is turned off.
- 2 Connect a composite cable (provided) to the **VIDEO** and **L** and **R** (audio in) jacks on the side of your TV and to the **AV OUT** jacks on the camcorder or game console.

Note

When you connect the audio using the **L** and **R** audio jacks, the audio output is analog.

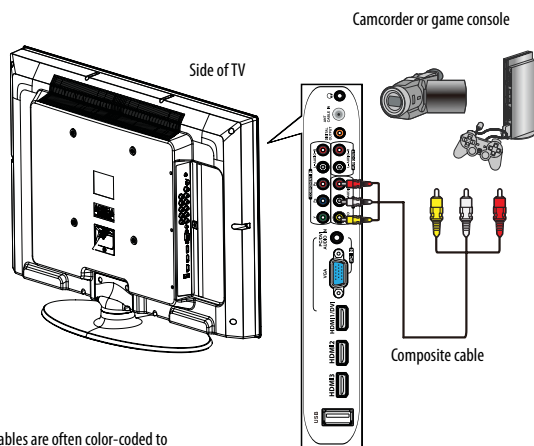

Cables are often color-coded to match color-coded jacks. Connect yellow to yellow, red to red, and white to white.

To play from the camcorder or game console:

- 1 Turn on your TV and the camcorder or game console, then press **INPUT** to open the **INPUT SOURCE** list.
- 2 Press **▲** or **▼** to select **AV**, then press **ENTER**.

Note

You can also press **VIDEO** to select the device.

Connecting a computer

Tip

Some computers have an HDMI jack. You can use an HDMI cable to connect the computer for a better picture.

Using VGA

To connect a computer using VGA:

- 1 Make sure that your TV's power cord is unplugged and the computer is turned off.
- 2 Connect a **VGA** cable (not provided) to the **VGA IN** jack on the back of your TV and to the **VGA** jack on the computer.

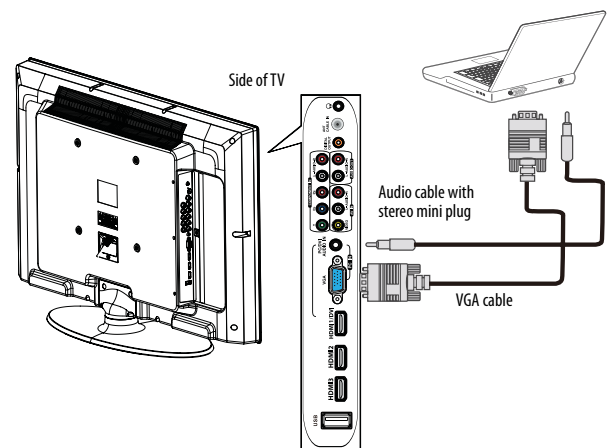

- 3 Connect an audio cable with stereo mini plug (not provided) to the **PC IN AUDIO** jack on the back of your TV and to the **LINE OUT** or **AUDIO OUT** jack on the computer.

To play video from the computer:

- 1 Turn on your TV, then press **INPUT** to open the **INPUT SOURCE** list.
- 2 Press **▲** or **▼** to select **VGA**, then press **ENTER**.
- 3 Turn on the computer and adjust the display properties if necessary.

Note

You can also press **VGA** to select the computer.

Using HDMI

To connect a computer using HDMI:

- 1 Make sure that your TV's power cord is unplugged and the computer is turned off.
- 2 Connect an HDMI cable (not provided) to one of the **HDMI** jacks on the side of your TV and to the **HDMI OUT** jack on the computer.

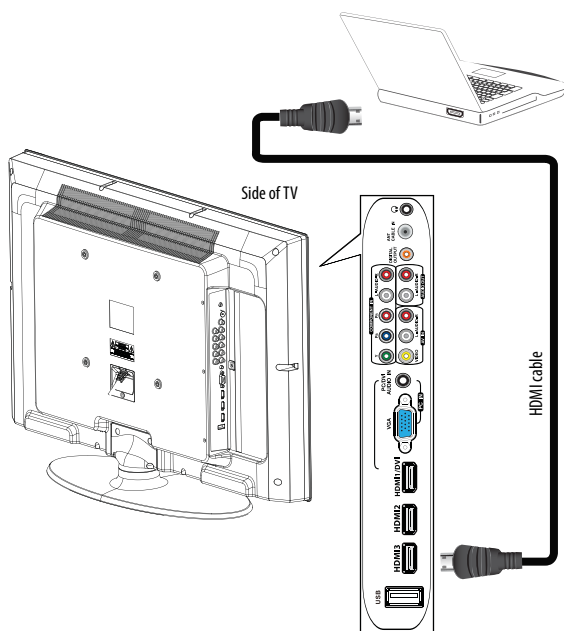

To play video from the computer:

- 1 Turn on your TV and the computer, then press **INPUT** to open the *INPUT SOURCE* list.
- 2 Press **▲** or **▼** to select **HDMI1**, **HDMI2**, or **HDMI3**, then press **ENTER**.

Note

You can also press **HDMI** repeatedly to select **HDMI1**, **HDMI2**, or **HDMI3**.

Connecting a USB flash drive

To connect a USB flash drive:

- 1 Plug a USB flash drive into the USB port on the side of your TV.

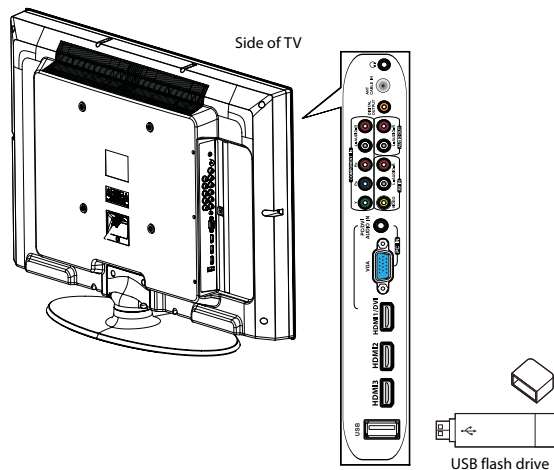

Caution

Removing the USB flash drive or turning off the TV while using the USB flash drive may result in loss of data or damage to the USB flash drive.

To play from a USB flash drive:

- 1 Turn on your TV, then press **INPUT** to open the *INPUT SOURCE* list.
- 2 Press **▲** or **▼** to select **USB**, then press **ENTER**.

Notes

- Never remove the USB flash drive or turn off your TV while viewing JPEG pictures.
- The JPEG picture viewer only supports JPEG format images (with "jpg" file extensions)
- Not all JPEG files are compatible with your TV.
- For more information, "[Using a USB flash drive](#)" on page 32

Connecting headphones

The TV speakers are muted when headphones are attached.

Warning

Loud noise can damage your hearing. When using headphones, use the lowest volume setting on your headphones that still lets you hear the sound.

To connect headphones:

- Connect headphones to the  (headphone) jack on the side of your TV.

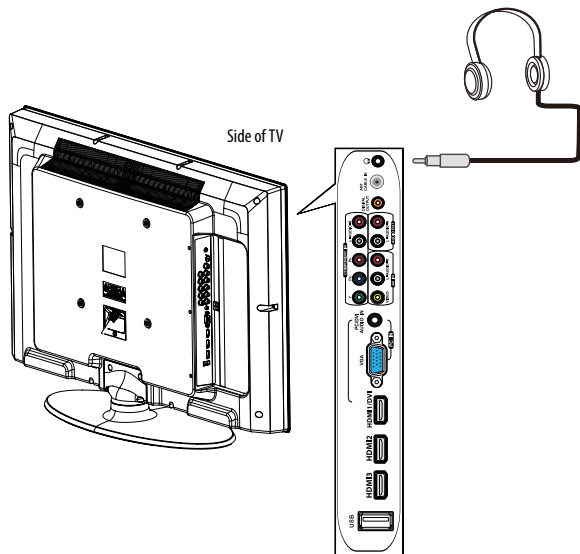

Connecting a basic home theater system

To connect a basic home theater system using analog audio:

- 1 Make sure that your TV's power cord is unplugged and the home system is turned off.
- 2 Connect a digital coaxial audio cable (not provided) to the **L/R** (audio out) jacks on the side of your TV and to the **AUDIO IN** jacks on the home theater system.

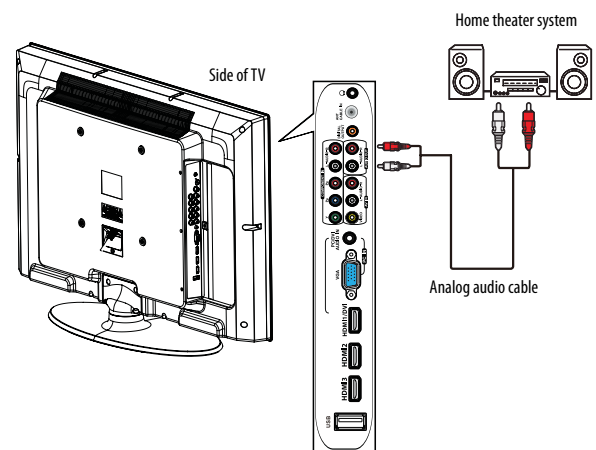

To connect a basic home theater system using digital audio:

- 1 Make sure that your TV's power cord is unplugged and the home system is turned off.
- 2 Connect a digital coaxial audio cable (not provided) to the **DIGITAL OUTPUT** jack on the side of your TV and to the **DIGITAL AUDIO IN** jack on the home theater system.

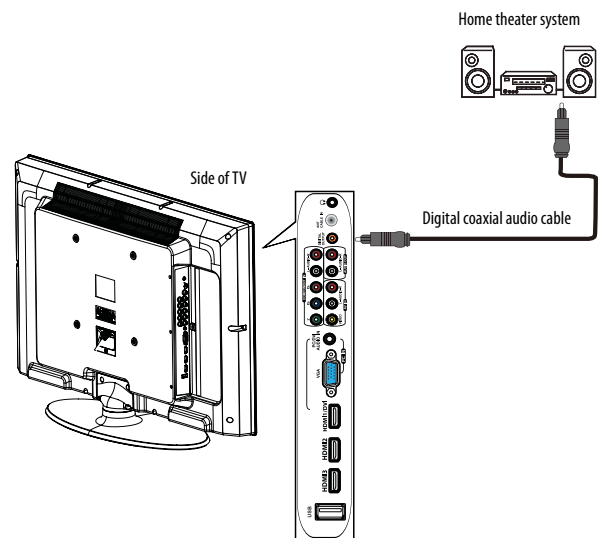

Connecting a home theater system with multiple devices

Notes

We recommend that you connect the AV receiver's **HDMI OUT** jack to one of your TV's **HDMI IN** jacks. Then, connect the AV receiver's **DIGITAL AUDIO INPUT** jack to your TV's **DIGITAL OUTPUT** jack to route Dolby Digital audio.

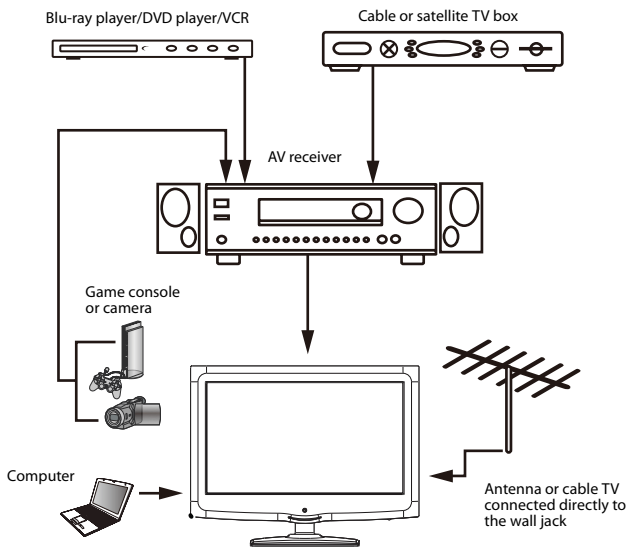

The connections you make depend on the video and audio jacks available on your devices. Refer to the documentation that came with your devices for connection information.

Remember to use the best connection types available for the best picture and sound. For information about connection types, see "What connection should I use?" on page 8.

Using the remote control

Installing remote control batteries

To install the remote control batteries:

- 1 While pressing the cover release latch on the back of the remote control, lift the cover off the remote control.

Remote Control 1

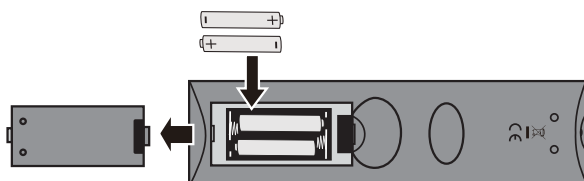

Remote Control 2

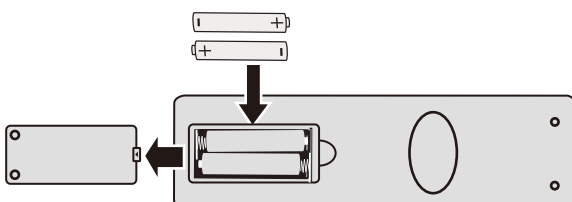

- 2 Insert two AAA batteries into the battery compartment. Make sure that you match the + and - symbols on the batteries with the + and - symbols in the battery compartment.
- 3 Replace the battery cover.

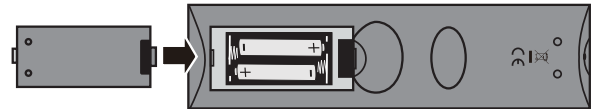

Remote Control 2

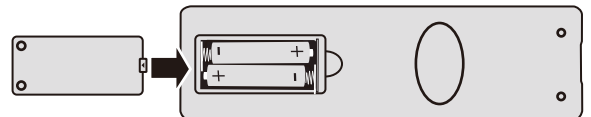

Cautions

- Batteries should not be exposed to excessive heat, such as sunshine, heat registers, or fire.
- Battery chemicals can cause a rash. If the batteries leak, clean the battery compartment with a cloth. If chemicals touch your skin, wash immediately.
- Make sure that batteries are disposed of correctly. Do not burn or incinerate.

Notes

- Do not mix batteries of different types.
- Do not mix old and new batteries.
- Remove batteries when the charge is depleted.
- If the remote control is not going to be used for an extended period of time, remove the batteries.

Aiming the remote control

To aim the remote control:

- Point the remote control towards the remote sensor on the front of your TV.

Turning on your TV for the first time

The first time you turn on your TV, the *Setup Wizard* opens. The *Setup Wizard* guides you through setting up basic settings including the menu language, date and time, picture mode, and TV signal source.

To set up your TV:

- 1 Make sure that you have:
 - Installed the remote control batteries. (See page 17 for details).
 - Connected an antenna, cable TV, or satellite TV. (See page 9 to page 11 for details.)
 - Connected the power cord. (See page 9 for details.)
- 2 Press **⏻** (Power), then wait several seconds. The *Choose Your Menu Language* screen opens.



- 3 Press **▲** or **▼** to highlight a language, then press **ENTER**. The *Choose Your Time Setting* screen opens.

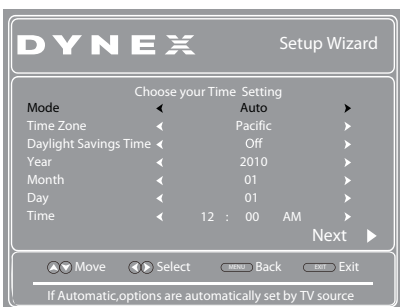

- 4 Press **▲** or **▼** to highlight **Mode**, then press **◀** or **▶** to select **Custom** (to set the date and time manually), or **Auto** (to set the date and time automatically from a TV signal source, based on the time zone you select).
- 5 If you selected **Auto** for mode, press **▲** or **▼** to highlight **Time Zone**, then press **◀** or **▶** to select your time zone. Choices include **Eastern, Central, Mountain, Pacific, Alaska, Hawaii, Atlantic, or Newfoundland**.
- 6 If you selected **Auto** for mode, press **▲** or **▼** to highlight **Daylight Savings**, then press **◀** or **▶** to select **On** (if your viewing area observes Daylight Savings Time), or **Off** (if your viewing area does not observe Daylight Savings Time).
- 7 If you selected **Custom** for **Mode**, set the date by pressing **▲** or **▼** to highlight **Year, Month, or Day**, then press **◀** or **▶** to change the setting.
- 8 If you selected **Custom** for **Mode**, set the time by pressing **▲** or **▼** to highlight **Time**, then press **◀** or **▶** to highlight the **hour, minute, or AM/PM**.
- 9 Press **▲** or **▼** to adjust the setting.

- 10 Press **ENTER**. The *Choose Your Picture Mode* screen opens.

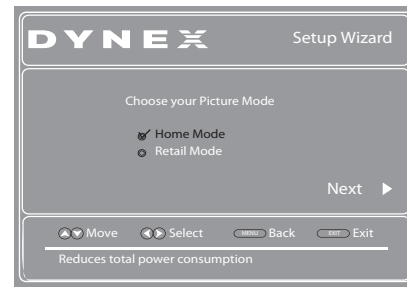

- 11 Press **▲** or **▼** to highlight **Home Mode** or **Retail Mode**, then press **ENTER**.

If you selected **Retail Mode**, a message appears "If you select Retail Mode, then Energy saving is not realized." Select **Yes** to continue, or select **No** to change your selection. The *Choose Your TV Source* screen opens.

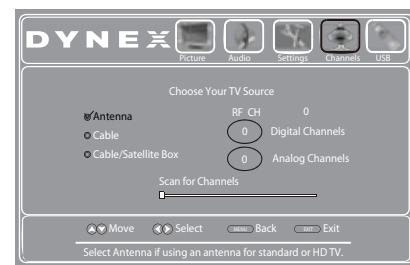

- 12 Press **▲** or **▼** to highlight **Antenna, Cable, or Cable/Satellite Box** (if your cable TV uses a box, select **Cable/Satellite Box**), then press **ENTER**.

- If you chose **Antenna** or **Cable**, your TV automatically starts scanning for channels available in your viewing area. If you chose **Cable/Satellite box**, your TV does not need to scan for channels.
- During the auto channel scan your TV searches for digital channels first. When the digital channel search is complete, a message appears asking if you want to search for analog channels. Select **Yes** to continue searching for analog channels, or **No** to stop searching for channels.

Note

The channel scan can take up to 20+ minutes. You can press **EXIT** at any time to stop the auto scan, but you will need to run the auto scan again to create a channel list.

- 13 To watch TV, press **INPUT**, press **▲** or **▼** to highlight the video input source for your TV in the *INPUT SOURCE* list, then press **ENTER**.

- If your TV is connected to an antenna, cable TV (no box), or cable or satellite TV box using a coaxial cable, select **TV**.
- If your TV is connected to a cable or satellite box using an HDMI cable or HDMI cable with a DVI adapter, select **HDMI**.
- If your TV is connected to a cable or satellite box using a component video cable, select **Component**.
- If your TV is connected to a cable or satellite box using a composite video cable, select **AV**.

Understanding the basics

Turning your TV on or off

To turn your TV on or off:

- 1 Make sure that the power cord is connected to a power outlet.
- 2 Press **⏻** (Power) to turn on your TV. The power indicator LED turns off.
- 3 Press **⏻** (Power) again to turn off your TV. Your TV enters Standby mode and the power indicator turns red.

Selecting the video input source

To select the video input source:

- 1 Turn on your TV, then press **INPUT**. The **INPUT SOURCE** list opens.

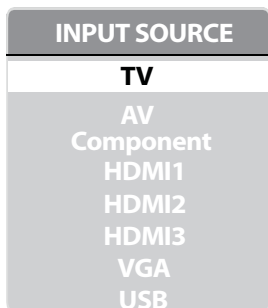

- 2 Press **▲** or **▼** to highlight the video input source, then press **ENTER**. You can also press a direct input button on the remote control to select the video input source.
 - Press **TV** to select **TV**.
 - Press **COMP** to select the device connected to the **COMPONENT IN** video jacks.
 - Press **VIDEO** to select the device connected to the **AV IN** jacks.
 - Press **VGA** to select the device connected to the **PC IN VGA** jack.
 - Press **HDMI** once to select **HDMI1**, twice to select **HDMI2**, and three times to select a device connected to an **HDMI3** jack.
 - Press **TV** to select the TV input source.

Using the on-screen menus

Notes

- Depending on the signal source selected, you may see different options on your screen. The following menus are shown in TV mode.
- Menu items that are not selectable are grayed out.
- Menus in this manual are described in TV mode, unless otherwise indicated.
- The screens shown in this manual are for explanation purposes and may vary from the actual screens on your TV.

Picture menu (TV mode)

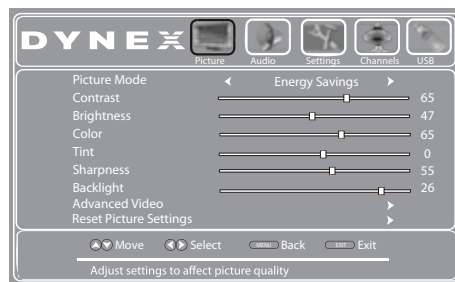

Audio menu (TV mode)

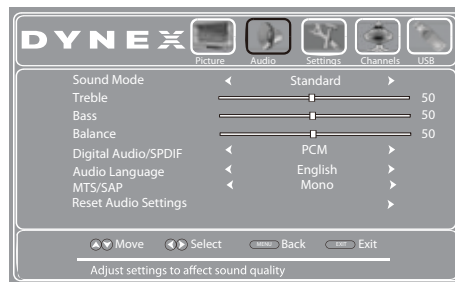

Settings menu (TV mode)

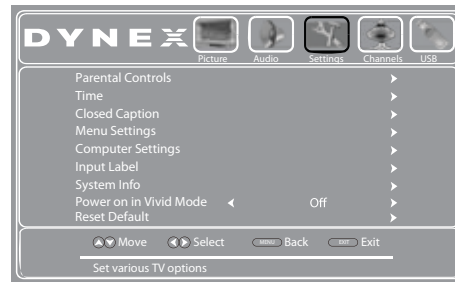

Channels menu (TV mode)



USB menu (USB mode)



Navigating the menus

Remote Control 1



Press **MENU** to open the on-screen menu.

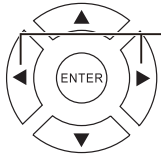

Press ◀ or ▶ to move the cursor on the screen or to adjust a selected item.

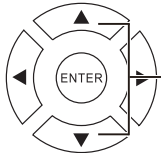

Press ▲ or ▼ to select menu options.

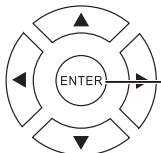

Press **ENTER** to confirm a selection or enter a sub-menu.



Press **MENU** to return to the previous menu.



Press **EXIT** to close the menu.

Remote Control 2



Press **MENU** to open the on-screen menu.

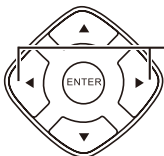

Press ◀ or ▶ to move the cursor on the screen or to adjust a selected item.

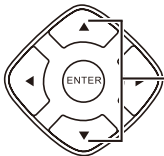

Press ▲ or ▼ to select menu options.

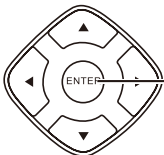

Press **ENTER** to confirm a selection or enter a sub-menu.



Press **MENU** to return to the previous menu.



Press **EXIT** to close the menu.

Selecting a channel

To select a channel:

- Press **CH+** or **CH-** to go to the next or previous channel on the memorized channel list.

- Press the number buttons to enter the channel number you want, then wait for the channel to change or press **ENTER** to immediately change the channel.
- To select a digital sub-channel, press the number buttons to select the main digital channel, press **.** (dot), then press the number button for the sub-channel. Wait for the channel to change, or press **ENTER** to immediately change the channel.
- Press **RECALL** to go to the last viewed channel. Press **RECALL** again to return to the channel you were watching.
- Press **CH-LIST** to open the channel list, press ▲ or ▼ to highlight a channel, then press **ENTER**. Hidden channels are grayed out on the Channel list.
- Press **FAV** or **FAVORITE** to open the favorite channel list, press ▲ or ▼ to highlight a channel, then press **ENTER**.

Note

If a list has more than one page, press ◀ or ▶ to scroll through the pages.

Adjusting the volume

To adjust the volume:

- Press **VOL+** or **VOL-** to increase or decrease the volume.
- Press **⊗ MUTE** to turn off the sound. Press **⊗ MUTE** again to turn the sound back on.

Viewing program information

To view channel information:

- Press **INFO** to view an information banner. The information banner shows the current program information such as channel number, video input source, and resolution.
 - Digital channel information—Displays the channel number, station name, channel label, broadcast program name, TV rating, signal type, audio information, resolution, CC mode, current time, and current program start and end times.
 - Analog channel information—Displays channel number, channel label (if preset), signal type, audio information, and resolution.

Adjusting the picture

Adjusting the TV picture

To adjust the TV picture:

- 1 Press **MENU**. The on-screen menu opens with the **Picture** menu displayed.

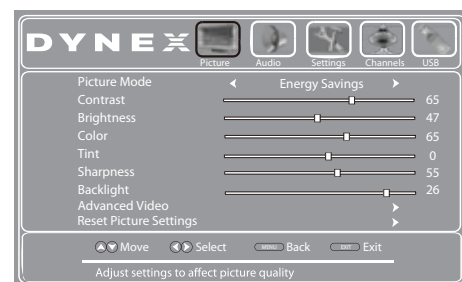

- 2 Press ▲ or ▼ to highlight an option, press ◀ or ▶ to adjust the setting, or press ▶ or **ENTER** to go to the sub-menu. You can select:





- **Picture Mode**—Selects the picture mode. You can select:
 - **Vivid**—(a bright and vivid picture) Significantly increases the contrast, brightness, and sharpness. This selection is good for video games, animation, and in bright light environments.
 - **Standard**—(a standard picture) Moderately increases the contrast, brightness, and sharpness. This selection is good for standard TV broadcasts.
 - **Energy Savings**—(the backlight brightness is decreased) Your TV has a backlight that provides light for displaying the picture. Your TV uses less energy when you reduce this backlight.
 - **Custom**—(customized picture) Lets you manually customize the picture settings such as brightness, contrast, and sharpness.

Note

You can also press **PICTURE** on your remote control to select the picture mode.

- **Contrast**—Adjusts the brightness of the light areas of the picture.
- **Brightness**—Adjusts the brightness of the dark areas of the picture.
- **Color**—Adjusts the color intensity of the picture. A low setting may make the color look faded. A high setting may make the color look artificial.
- **Tint**—Adjusts the color balance of the picture. Use this control to make skin tones look more natural.
- **Sharpness**—Adjusts the color detail of images. If you set this control too high, dark images may appear with light or white edges.
- **Backlight**—Increasing the backlight setting will increase the brightness and display performance of the screen. The higher the setting is, the higher the power consumption.
- **Advanced Video**—Opens the *Advanced Video* sub-menu where you can adjust additional video options.

- **Aspect Ratio**—Selects the aspect ratio of the picture.

Aspect ratio option	Example
Normal: Displays the original 4:3 aspect ratio with vertical black bars on the left and right of the image. If the original aspect ratio is 16:9, the image displays in 16:9.	
Zoom: Expands the image to fill the screen. The top and bottom of the image may be cropped.	
Wide: Use this option to view content recorded in a 16:9 (wide-screen) aspect ratio.	
Cinema: Stretches the image at the edges, but keeps a clear image in the center.	
Auto: The picture display is adjusted to the correct aspect ratio automatically (TV mode only). This setting is only active when Auto Zoom in the <i>Channels</i> menu is set to On .	

Note

You can also press **ZOOM** to select the aspect ratio.

- **Color Temperature**—Selects the color temperature. You can select **Cool** (to enhance the blues), **Normal**, or **Warm** (to enhance the reds).
- **Noise Reduction**—Selects the noise reduction mode to reduce picture noise (snow). You can select **Low**, **Middle**, **Strong**, or **Off**.
- **Aspect Ratio**—**Cinema**, **Auto**, **Normal**, **Wide**, or **Zoom**.
- **Overscan**—This feature extends part of the display past the visible area of the screen. The resulting picture will “zoom in” on the image center. You can select **On** or **Off**.
- **Adaptive Contrast**—Automatically adjusts picture detail and brightness. You can select **On** or **Off**.
- **Dynamic Contrast Ratio**—Enhances the contrast ratio between light and dark areas of the picture. You can select **On** or **Off**. If this is set to **On**, **Backlight** cannot be adjusted.
- **Reset Picture Settings**—Reset all picture settings to factory mode.

- 3 Press **MENU** to return to the previous menu, or press **EXIT** to close the menu.

Adjusting the computer image

To adjust the computer image:

- 1 Make sure that your TV is in VGA mode. For more information, see "Selecting the video input source" on page 19.
- 2 Press **MENU**. The on-screen menu opens with the *Picture* menu displayed.

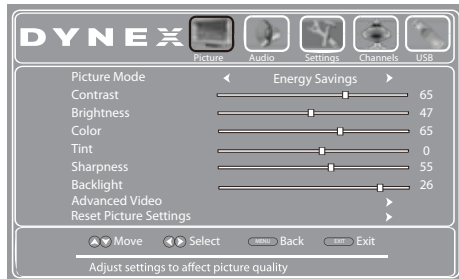

- 3 Press ◀ or ▶ to highlight **Settings**, then press ▼. The *Settings* menu opens.

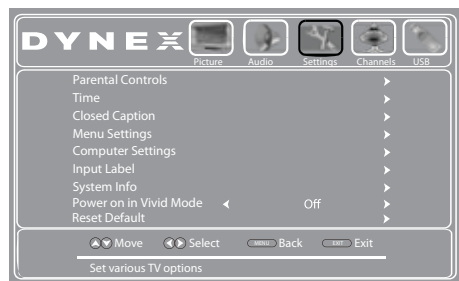

- 4 Press ▲ or ▼ to highlight **Computer Settings**, then press **ENTER**. The *Settings-Computer settings* menu opens.
- 5 Press ▲ or ▼ to highlight an option, then press ◀ or ▶ to adjust the option. You can select:
 - **Auto Adjust**—Automatically adjusts the image settings such as position and phase.
 - **H. Position**—Moves the image right or left.
 - **V. Position**—Moves the image up or down.
 - **Clock**—Adjusts the sample frequency.
 - **Phase**—Adjusts the focus of stable images.
- 6 Press **MENU** to return to the previous menu, or press **EXIT** to close the menu.

Adjusting the sound

Adjusting sound settings

To adjust the sound settings:

- 1 Press **MENU**. The on-screen menu opens with the *Picture* menu displayed.

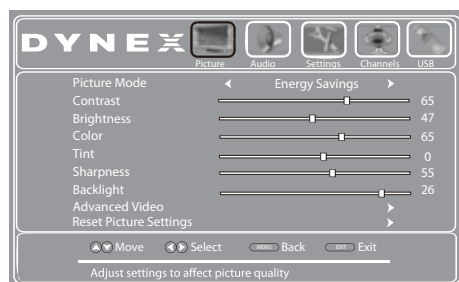

- 2 Press ◀ or ▶ to highlight **Audio**, then press ▼. The *Audio* menu opens.

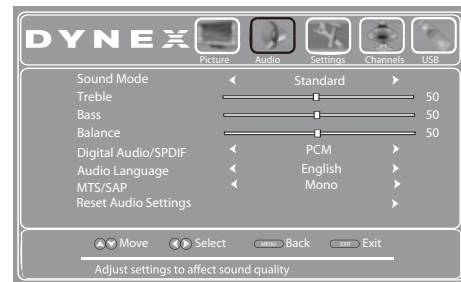

- 3 Press ▲ or ▼ to highlight an option, then press ◀ or ▶ to adjust the setting. You can select:
 - **Sound Mode**—Selects the EQ sound mode. You can select **Standard**, **News**, **Music**, **Movie**, or **Custom**.

Note

You can also press **AUDIO** on the remote control to select the audio mode.

- **Treble**—Adjusts the high sounds.
- **Bass**—Adjusts the low sounds.
- **Balance**—Adjusts the balance between the left and right audio channels.
- **Digital Audio/SPDIF**—Selects the preferred audio format for digital audio signals. Options include **PCM** (to output the audio in 2-channel stereo), or **RAW** (to pass through the original digital audio sound).
- **Audio Language**—Selects the default language track when watching digital TV programs. Options include **English**, **Français** (French), and **Español** (Spanish).
- **MTS/SAP**—(Analog channels only) Selects the audio mode. You can select:
 - **Mono**—if there is noise or static on weak stereo broadcasts.
 - **Stereo**—for programs broadcast in stereo.
 - **SAP**—to listen to a secondary audio program (if available).

Note

You can also press **MTS/SAP** on the remote control one or more times to select the audio mode.

- **Reset Audio Settings**—Resets all audio settings to factory defaults.

- 4 Press **MENU** to return to the previous menu, or press **EXIT** to close the menu.

Playing TV audio only

You can turn off the picture on your TV and listen to the program audio only.

To play TV audio only:

- 1 Press **MENU**. The on-screen menu opens with the *Picture* menu displayed.

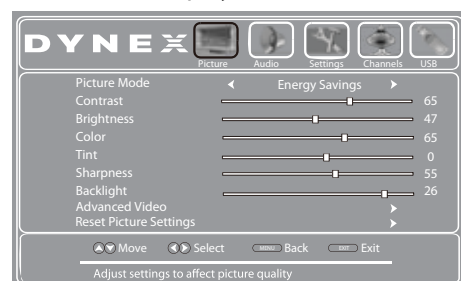

- Press **◀** or **▶** to highlight **Channels**, then press **▼**. The *Channels* menu opens.



- Press **▲** or **▼** to highlight **Audio Only**, then press **ENTER**.
- Press **◀** or **▶** to select **On**.
- Press **MENU** to return to the previous menu, or press **EXIT** to close the menu. The picture turns off in approximately 3 to 5 seconds.

Notes

- Audio only works only when the input source is TV and your TV is receiving a broadcast signal.
- To exit audio only mode, press any button except the power button. When you exit audio only mode, the **Audio Only** option is automatically reset to **Off**.

- Press **▲** or **▼** to highlight **Auto Channel Scan**, then press **ENTER**. The *CHANNELS-Auto Channel Scan* screen opens.

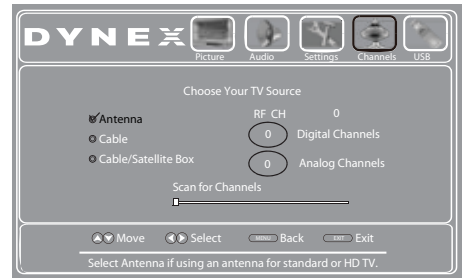

- Press **▲** or **▼** to highlight **Antenna, Cable, or Cable/Satellite Box**, then press **ENTER**.
 - If you are using an antenna for a standard or HD TV signal, select **Antenna**.
 - If your cable is connected directly to the TV (using no tuner box), select **Cable**.
 - If your cable is connected to your TV through a tuner box, select **Cable/Satellite Box**.

If you selected **Antenna** or **Cable**, your TV searches automatically for available channels in your area and stores the channel information in the channel list. This may take several minutes. While scanning, the TV displays a progress report.

- Or -

If you selected **Cable/Satellite Box**, the channel search is not necessary.

Note
You can press **EXIT** at any time to stop scanning, but you must run the scan later to complete the process.

Changing channel settings

Automatically scanning for channels

When you scan for channels, your TV searches for channels available in your viewing area and stores the channel information in the channel list. When you press **CH+** or **CH-**, your TV goes to the next or previous channel in the channel list.

If the TV signal source changes, for example you change from an outdoor antenna to cable TV (no box), you need to scan for channels again.

To automatically scan for channels:

- Press **MENU**. The on-screen menu opens with the *Picture* menu displayed.

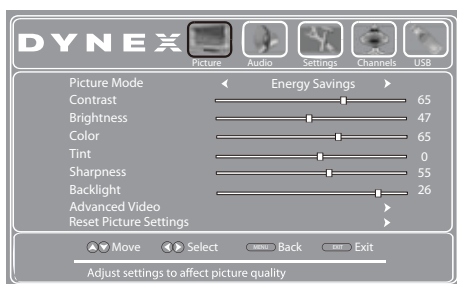

- Press **◀** or **▶** to highlight **Channels**, then press **▼**. The *Channels* menu opens.



Hiding channels

You can hide channels in the channel list. When you press **CH▲** or **CH▼**, your TV skips the hidden channels. You can still tune to a hidden channel by pressing the number buttons for the channel.

To hide channels:

- Press **MENU**. The on-screen menu opens with the *Picture* menu displayed.

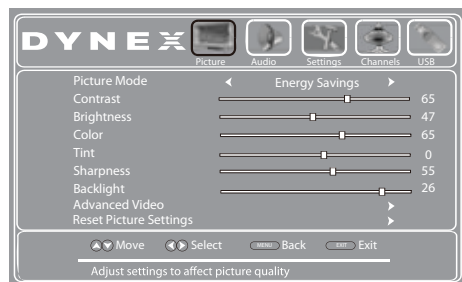

- Press **◀** or **▶** to highlight **Channels**, then press **▼**. The *Channels* menu opens.



- Press **▲** or **▼** to highlight **Add/Skip Channels**, then press **ENTER**. The channel list opens.

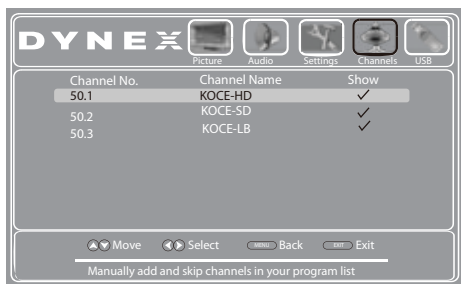

- Press **▲** or **▼** to highlight the channel you want to hide, then press **ENTER**. The check mark disappears.

Notes

- A channel with a check mark is not hidden. A channel with no check mark is hidden.
- If the list has more than one page, press **▲** or **▼** to scroll through the pages.

- Press **MENU** to return to the previous menu, or press **EXIT** to close the menu.

Setting up a favorite channel list

You can create a favorite channel list to make it easier to tune to your favorite channels.

To set up a favorite channel list:

- Press **MENU**. The on-screen menu opens with the *Picture* menu displayed.

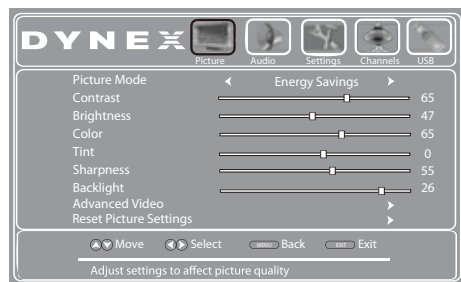

- Press **◀** or **▶** to highlight **Channels**, then press **▼**. The *Channels* menu opens.



- Press **▲** or **▼** to highlight **Favorites**, then press **ENTER**. The *Channels-favorites* list opens.

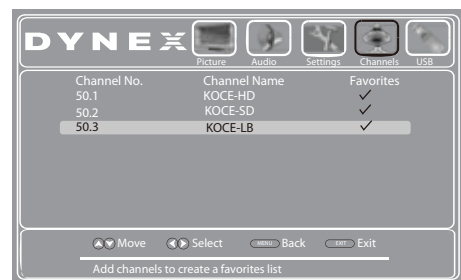

- Press **▲** or **▼** to highlight the channel you want to add to the favorites list, then press **ENTER**. A check mark appears.

Notes

- To remove a channel from the favorites list, highlight the channel, then press **ENTER**. The check mark disappears and the channel is removed from the list.
- If the list has more than one page, press **▲** or **▼** to scroll through the pages.

- Press **MENU** to return to the previous menu, or press **EXIT** to close the menu.

Viewing a favorite channel

To view a favorite channel:

- Press **FAV** or **FAVORITE** on your remote control. The *Favorites* channel list opens.
- Press **▲** or **▼** to highlight a channel, then press **ENTER** to tune to the channel.

Adding or changing a channel label

If a channel is not already labeled, you can label the channel to make it easier to identify. You can also relabel a channel that is already labeled.

To add or change a channel label:

- Press **MENU**. The on-screen menu opens with the *Picture* menu displayed.

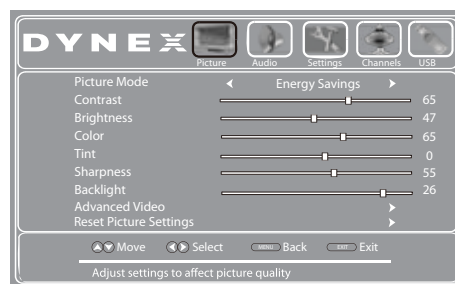

- Press **◀** or **▶** to highlight **Channels**, then press **▼**. The *Channels* menu opens.



- Press **▲** or **▼** to highlight **Channel Label**, then press **ENTER**. The *Channel Label* screen opens with the channel number field highlighted.

- Press **▲** or **▼** to select the channel you want to label, then press **▶** to go to the channel label editing field.

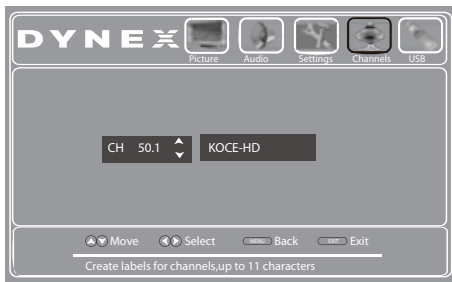

- Press **▲** or **▼** to select a character, then press **◀** or **▶** to move to the previous or next position. Repeat this step to add more characters. You can enter as many as 11 characters. If you need to delete a character, enter a blank space, then press **ENTER**.
- When you have completed the label, press **ENTER**.
- Press **MENU** to return to the previous menu, or press **EXIT** to close the menu.

Checking the digital signal strength

You can check the digital signal strength to determine if you need to adjust your antenna or digital cable input. The higher the signal strength, the less likely you are to experience picture degradation.

To check the digital signal strength:

- Press **MENU**. The on-screen menu opens with the *Picture* menu displayed.

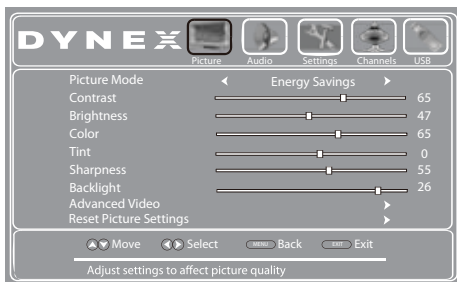

- Press **◀** or **▶** to highlight **Channels**, then press **▼**. The *Channels* menu opens.



- Press **▲** or **▼** to highlight **Channel Strength**, then press **ENTER**. The DTV signal strength is indicated by the color bar.
- Press **MENU** to return to the previous menu, or press **EXIT** to close the menu.

Setting parental controls

Parental controls let you prevent your children from watching inappropriate material on TV. When set, parental controls read the rating of the program (with some exceptions, such as news and sports) and deny access to programs that exceed the ratings level you select. To watch programs that exceed the selected rating, you must enter the password.

Setting or changing the password

To set or change the password:

- Press **MENU**. The on-screen menu opens with the *Picture* menu displayed.

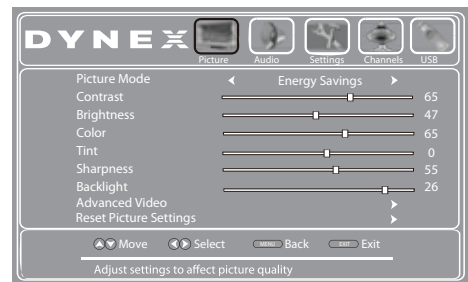

- Press **◀** or **▶** to highlight **Settings**, then press **▼**. The *Settings* menu opens with **Parental Controls** highlighted.



- Press **ENTER**. The *Enter Password* screen opens.

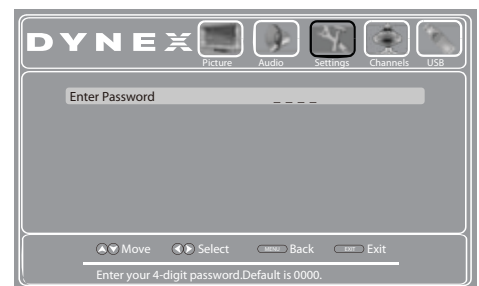

- Press the number buttons to enter the four-digit password. The default password is **0000**. You should change the password to something you can remember. The *Parental Controls* menu opens.

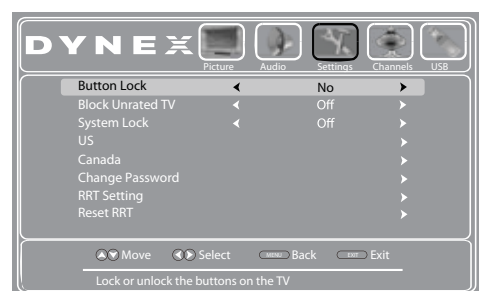

- 5 Press **▲** or **▼** to highlight **Change Password**, then press **ENTER**. The *Password Entry* screen opens.



- 6 Press the number buttons to enter the old password, enter a new password, then enter the new password again. The password has been successfully changed.

Note

If you forget your password, enter **9999**.

- 7 Press **EXIT** to close the menu.

Locking control buttons

You can lock the TV control buttons on the side of your TV. When the control buttons on your TV are locked, you can only operate the TV with the remote control.

To lock control buttons:

- 1 Press **MENU**. The on-screen menu opens with the *Picture* menu displayed.

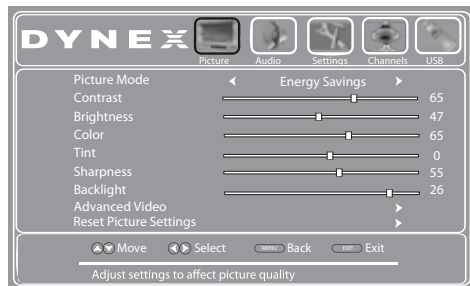

- 2 Press **◀** or **▶** to highlight **Settings**, then press **▼**. The *Settings* menu opens with **Parental Controls** highlighted.

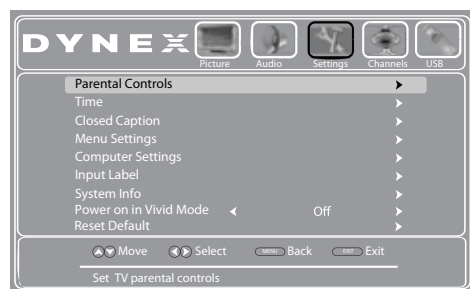

- 3 Press **ENTER**. The *Enter Password* screen opens.

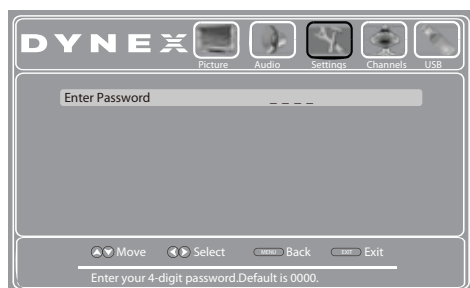

- 4 Press the number buttons to enter the four-digit password. The *Parental Controls* menu opens with **Button Lock** highlighted.



- 5 Press **◀** or **▶** to select **Yes** (to lock the buttons), or **No** (to unlock the buttons).

- 6 Press **EXIT** to close the menu.

Setting parental control levels

You can set parental control levels for the U.S. and Canada. The following procedure shows how to set controls for U.S. TV and movie ratings. You use similar steps for controlling Canadian TV ratings. Parental control settings are only applicable to programs that have a rating signal.

To set parental control levels:

- 1 Press **MENU**. The on-screen menu opens with the *Picture* menu displayed.

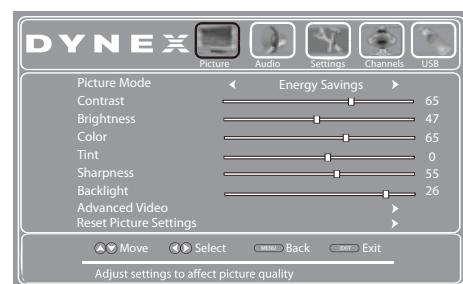

- 2 Press **◀** or **▶** to highlight **Settings**, then press **▼**. The *Settings* menu opens with **Parental Controls** highlighted.

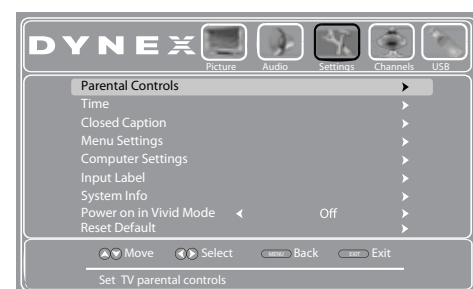

- 3 Press **ENTER**. The *Enter Password* screen opens.



- 4 Press the number buttons to enter the four-digit password. The *Parental Controls* menu opens.

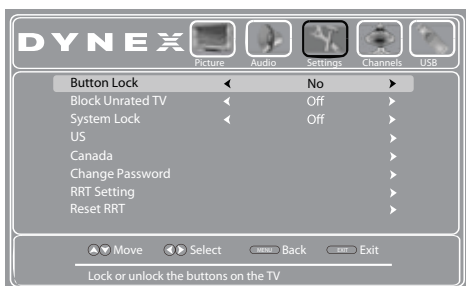

- 5 Press **▲** or **▼** to highlight **US** (or **Canada** to set controls for Canada), then press **ENTER**. The *Ratings* screen opens.

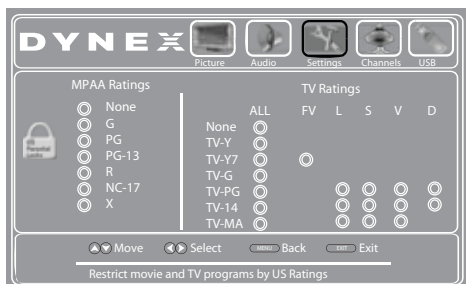

- 6 Press **▲** or **▼**, **◀** or **▶** to highlight the rating you want to block, then press **ENTER**. A lock icons appear next to a rating is blocked.

Note

When you block a rating, that rating and all higher ratings are blocked.

- 7 Press **EXIT** to close the menu.

Ratings

U.S. TV ratings (age-based)	
None	Not rated
TV-Y	All children
TV-Y7	Children over seven years of age
TV-G	General audiences
TV-PG	Parental guidance suggested
TV-14	Parents strongly cautioned
TV-MA	Mature audiences only

U.S. TV ratings (content-based)	
All	All ratings are blocked
FV	Fantasy violence
L	Adult language
S	Sexual situations
V	Violence
D	Sexually suggestive dialog

U.S. movie (MPAA) ratings	
None	Movie not rated
G	General audiences
PG	Parental guidance suggested
PG-13	Suitable for children 13 and older
R	Parental guidance suggested for children under 17
NC-17	Not suitable for children under 17
X	Adults only

Canadian English ratings	
E	Exempt programming
C	Children
C8+	Children over 8 years old
G	General audiences
PG	Parental guidance
14+	Over 14 years old
18+	Adult programming

Canadian French ratings	
E	Exempt programming
G	General audiences
8 ans+	Over 8 years old
13 ans+	Over 13 years old
16 ans+	Over 16 years old
18 ans+	Adult programming

Downloading rating information

To download rating information:

- 1 Press **MENU**. The on-screen menu opens with the *Picture* menu displayed.

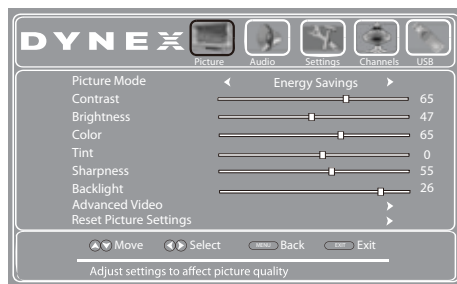

- 2 Press **◀** or **▶** to highlight **Settings**, then press **▼**. The *Settings* menu opens with **Parental Controls** highlighted.



- 3 Press **ENTER**. The *Enter Password* screen opens.



- 4 Press the number buttons to enter the four-digit password. The *Parental Controls* menu opens.

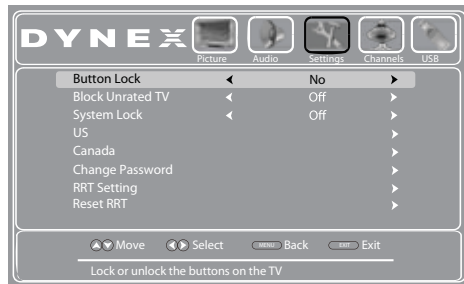

- 5 Press **▲** or **▼** to highlight **RRT Setting**, then press **ENTER**. If the program is broadcast with RRT rating information, the information is downloaded automatically and can be used for parental controls.
- 6 Press **EXIT** to close the menu.

Using closed captioning

Closed captions (CC or subtitles) are intended to provide people who are hearing impaired with access to TV programs. However, this feature is also useful for viewers who are learning a new language, beginning to read, or in a noisy environment. Text captions are displayed to transcribe speech and often other relevant sounds. Closed captioning availability and content depends on the broadcaster and may vary across programs in a channel.

Turning closed captioning on or off

To turn closed captioning on or off:

- 1 Press **MENU**. The on-screen menu opens with the *Picture* menu displayed.

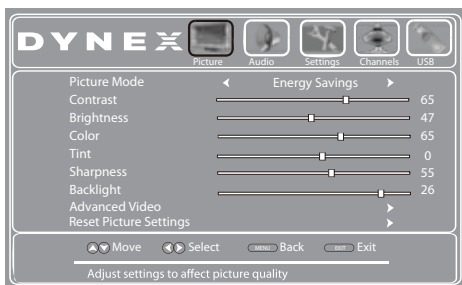

- 2 Press **◀** or **▶** to highlight **Settings**, then press **▼**. The *Settings* menu opens.

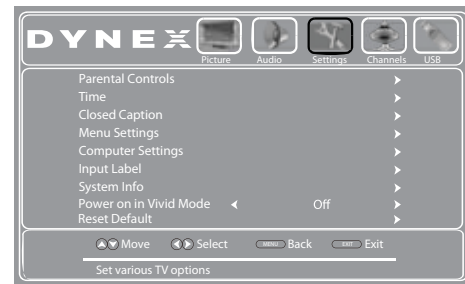

- 3 Press **▲** or **▼** to highlight **Closed Caption**, then press **ENTER**. The *Settings-Closed Caption* menu opens.

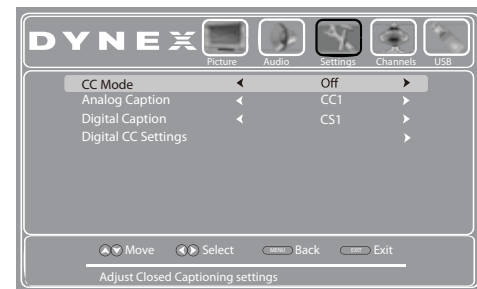

- 4 Press **▲** or **▼** to highlight **Caption Control**, then press **ENTER**. A menu opens.

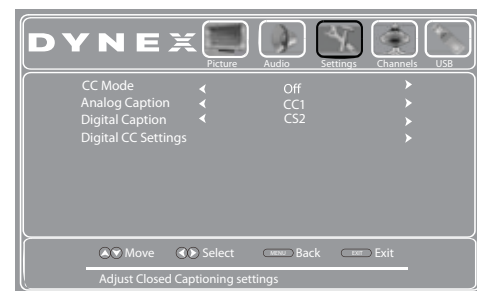

- 5 Press **◀** or **▶** to select **On** (turns closed captioning on), **CC On When Mute** (turns closed captioning on when the sound is muted), or **Off** (turns closed captioning off).
- 6 Press **MENU** to return to the previous menu, or press **EXIT** to close the menu.

Note

You can also press **CCD** on the remote control to turn closed captioning on or off.

Selecting the analog closed captioning mode

To select the closed captioning mode:

- 1 Press **MENU**. The on-screen menu opens with the *Picture* menu displayed.

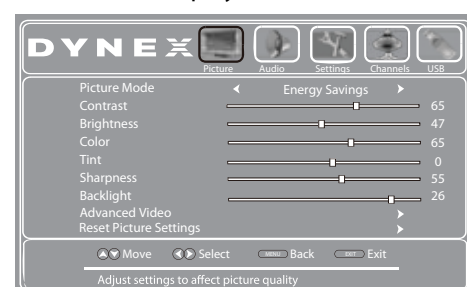

- 2 Press **◀** or **▶** to highlight **Settings**, then press **▼**. The *Settings* menu opens.



- 3 Press **▲** or **▼** to highlight **Closed Caption**, then press **ENTER**. The *Settings-Closed Caption* menu opens.

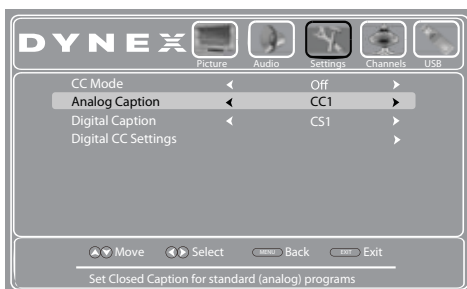

- 4 Press **▲** or **▼** to highlight **Analog Caption**, then press **◀** or **▶** to select an analog caption setting. You can select:

- **CC1** through **CC4**—Closed captioning appears in a small banner across the bottom of the screen. **CC1** is usually the “printed” version of the audio. **CC2** through **CC4** display content provided by the broadcaster.
- **Text1** through **Text4**—Closed captioning that covers half or all of the screen. **Text1** through **Text4** display content provided by the broadcaster.

- 5 Press **EXIT** to close the menu.

Customizing digital closed captioning styles

To customize digital closed captioning styles:

- 1 Press **MENU**. The on-screen menu opens with the *Picture* menu displayed.

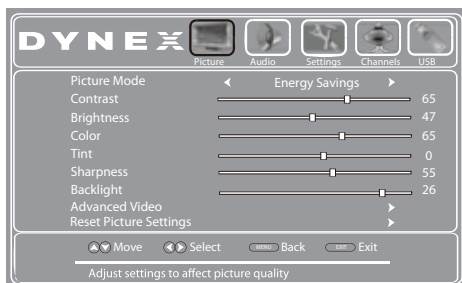

- 2 Press **◀** or **▶** to highlight **Settings**, then press **▼**. The *Settings* menu opens.



- 3 Press **▲** or **▼** to highlight **Closed Caption**, then press **ENTER**. The *Settings-Closed Caption* menu opens.

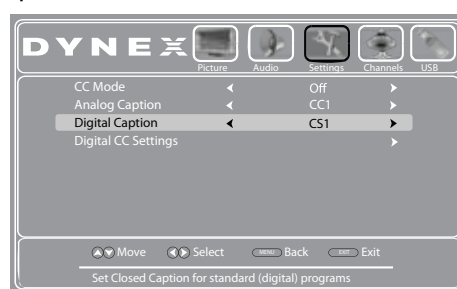

- 4 Press **▲** or **▼** to highlight **Digital Caption** (only available for digital stations), then press **◀** or **▶** to select a digital caption setting. You can select **CC1** through **CC4** and **CS1** through **CS6**.

- 5 Press **▲** or **▼** to highlight **Digital CC Settings**, then press **ENTER**. The *Digital CC Settings* menu opens.

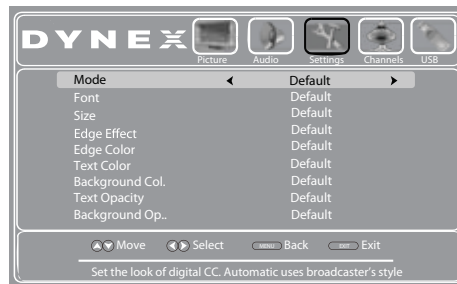

- 6 Press **▲** or **▼** to highlight **Mode**, then press **◀** or **▶** to select **Custom**.

Note

To reset the closed caption styles to their defaults, set **Mode** to **Default**.

- 7 Press **▲** or **▼** to highlight a style, then press **◀** or **▶** to adjust the style. You can select:

- **Font**—Selects the font style.
- **Size**—Selects the font size.
- **Text Color**—Selects the color for the text.
- **Text Opacity**—Selects the opacity for the text.
- **Background Color**—Selects the color for the background.
- **Background Opacity**—Selects the opacity for the background.
- **Edge Effect**—Selects the edge style for the words.
- **Edge Color**—Selects the color for the edges.

- 8 Press **EXIT** to close the menu.

Adjusting time settings

Setting the clock

To set the clock:

- 1 Press **MENU**. The on-screen menu opens with the *Picture* menu displayed.

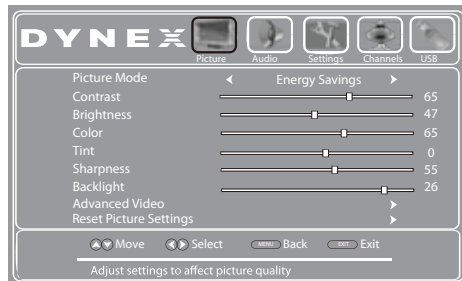

- 2 Press **◀** or **▶** to highlight **Settings**, then press **▼**. The *Settings* menu opens.

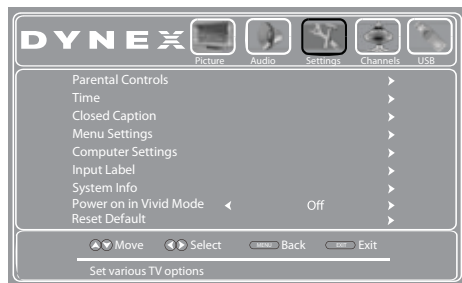

- 3 Press **▲** or **▼** to highlight **Time**, then press **ENTER**. The *Settings-Time* menu opens.

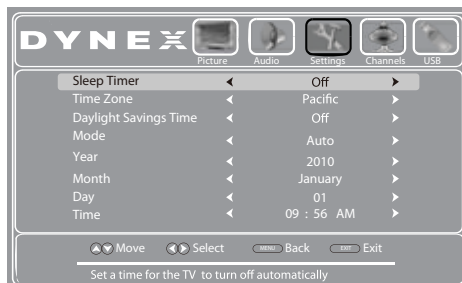

- 4 Press **▲** or **▼** to highlight **Mode**, then press **◀** or **▶** to select **Custom** (to set the date and time manually, or **Auto** (to have the date and time set automatically from a TV signal source, based on your time zone).
- 5 If you selected **Auto** for **Mode**, press **▲** or **▼** to highlight **Time Zone**, then press **◀** or **▶** to select your time zone. You can select **Eastern, Central, Mountain, Pacific, Alaska, Hawaii, Atlantic, or Newfoundland**.
- 6 If your viewing area observes daylight savings time, press **▲** or **▼** to highlight **Daylight Savings Time**, then press **◀** or **▶** to select **On** or **Off**.
- 7 If you selected **Custom** for **Mode**:
 - Press **▲** or **▼** to highlight **Year, Month, or Day**, then press **◀** or **▶** to adjust the setting.
 - Press **▲** or **▼** to highlight **Time**, press **◀** or **▶** to highlight the hour, minute, or AM/PM field, then press **▲** or **▼** to adjust the setting.
- 8 Press **EXIT** to close the menu.

Setting the sleep timer

You can set the amount of time before your TV automatically turns off.

To set the sleep timer:

- 1 Press **MENU**. The on-screen menu opens with the *Picture* menu displayed.

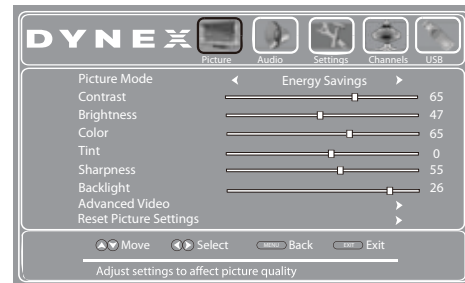

- 2 Press **◀** or **▶** to highlight **Settings**, then press **▼**. The *Settings* menu opens.

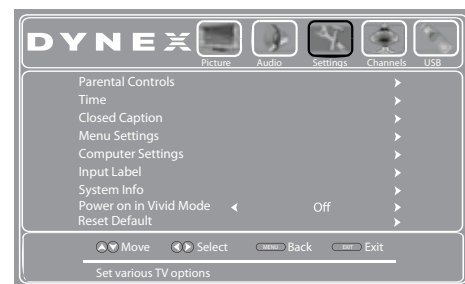

- 3 Press **▲** or **▼** to highlight **Time**, then press **▶** or **ENTER**. The *Settings-Time* menu opens.



- 4 Press **▲** or **▼** to highlight **Sleep Timer**, then press **◀** or **▶** to select the amount of time (**Off, 5 minutes, 10 minutes, 15 minutes, 30 minutes, 60 minutes, 90 minutes, 120 minutes, 180 minutes, 240 minutes**) before your TV turns off automatically. To turn the sleep timer off, select **Off**.
- 5 Press **EXIT** to close the menu.

Note

You can also press **SLEEP** on the remote control to set the sleep timer.

Adjusting menu settings

Selecting the menu language

To select the on-screen menu language:

- 1 Press **MENU**. The on-screen menu opens with the *Picture* menu displayed.

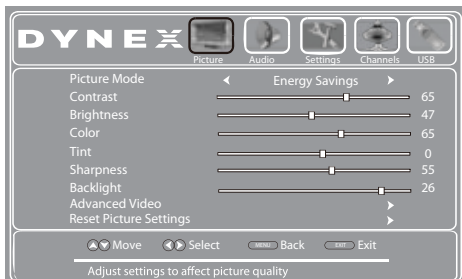

- 2 Press **◀** or **▶** to highlight **Settings**, then press **▼**. The *Settings* menu opens.

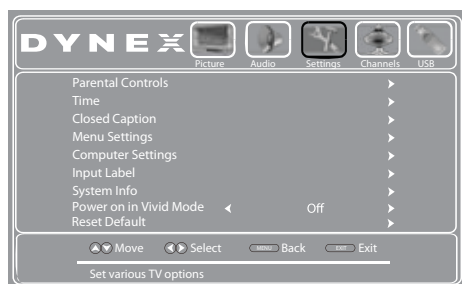

- 3 Press **▲** or **▼** to highlight **Menu Settings**, then press **▶** or **ENTER**. The *Settings-Menu Settings* menu opens with **Menu Language** highlighted.
- 4 Press **◀** or **▶** to select the menu language you want. You can select **English**, **French**, or **Spanish**.
- 5 Press **EXIT** to close the menu.

Labeling an input source

You can add a label to a video input source to make it easier to identify. These labels are displayed on the *INPUT SOURCE* list and on the banner that appears when you press **INFO**.

To label an input source:

- 1 Press **MENU**. The on-screen menu opens with the *Picture* menu displayed.

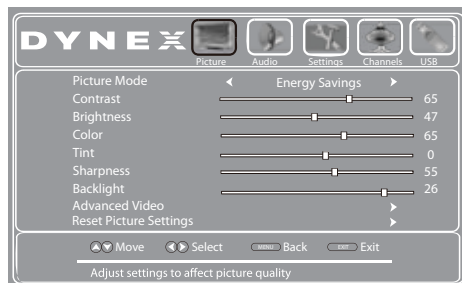

- 2 Press **◀** or **▶** to highlight **Settings**, then press **▼**. The *Settings* menu opens.

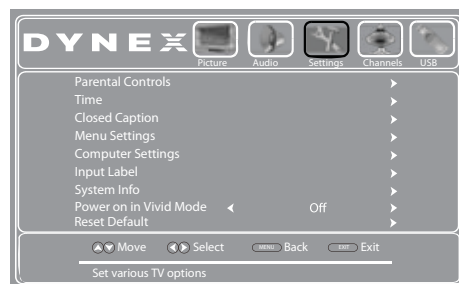

- 3 Press **▲** or **▼** to highlight **Input Labels**, then press **ENTER**. The *Settings-Input Label* screen opens with **Present Label** highlighted.

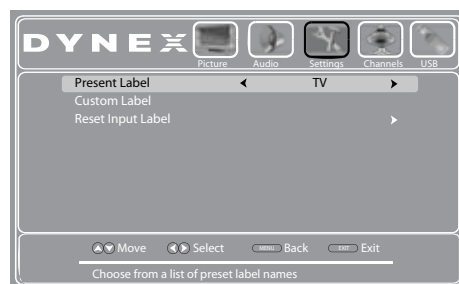

- 4 Press **◀** or **▶** to select a preset label from several options, or select **Custom** to enter your own label.

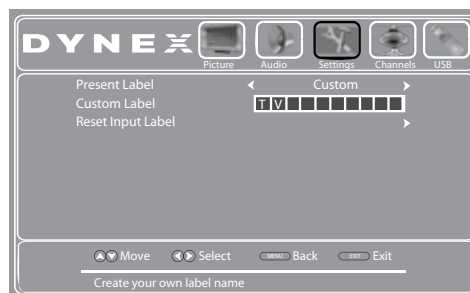

- 5 If you select **Custom**, press **▲** or **▼** to highlight **Custom Label**, then press **▶**.
- 6 Press **▲** or **▼** to select a character.
- 7 Press **▶** to move to the next position. Repeat this step to enter additional characters. You can enter as many as 10 characters. If you need to delete a character, enter a blank space, then press **ENTER**.
- 8 When you complete the label, press **MENU**. The next time you press **INPUT**, the new label appears in the *INPUT SOURCE* list.
- 9 Press **EXIT** to close the menu.

Restoring settings to default

Caution

When you restore default settings, all the settings (except the password and parental rating) you have customized are reset.

To restore settings to default:

- 1 Press **MENU**. The on-screen menu opens with the *Picture* menu displayed.

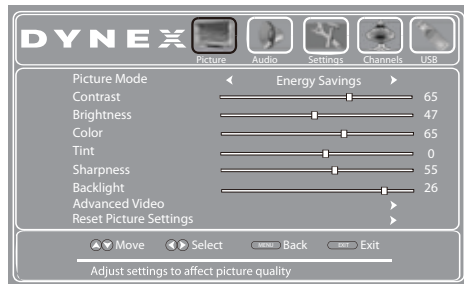

- 2 Press **◀** or **▶** to highlight **Settings**, then press **▼**. The *Settings* menu opens.



- 3 Press **▲** or **▼** to highlight **Reset Default**, then press **ENTER**. A confirmation box opens.
- 4 Press **◀** or **▶** to select **Yes** (to reset all settings to factory default), or **No** (to not reset).
- 5 Press **EXIT** to close the menu.

Using a USB flash drive

You can connect a USB flash drive to your TV to view compatible JPEG pictures.

Notes

The JPEG picture viewer only supports JPEG format images (with ".jpg" file extensions).
Not all JPEG files are compatible with your TV.

Switching to USB mode

To switch to USB mode:

- 1 Make sure that you have connected the USB flash drive to the USB port on the side of your TV.
- 2 Press **INPUT**. The *INPUT SOURCE* list opens.
- 3 Press **▲** or **▼** to highlight **USB**, then press **ENTER**.

Note

To exit USB mode, press **INPUT** to open the *INPUT SOURCE* list, then select another input source.

Browsing photos

To browse photos on a USB flash drive:

- 1 Switch to USB mode (see above).
- 2 Press **MENU**. The *USB* menu opens.

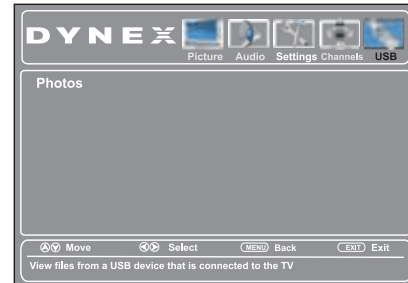

- 3 Press **▼** to access the menu. **Photos** is highlighted.

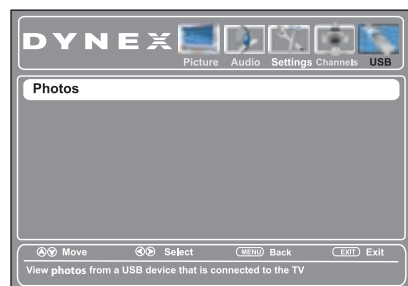

- 4 Press **ENTER** to access the menu. The *USB Photos* menu opens with **Browse Photos** highlighted.

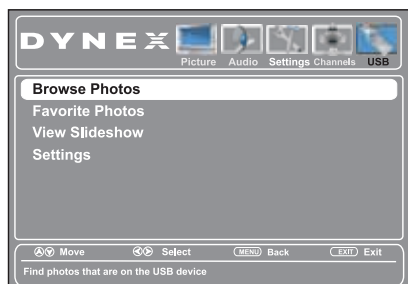

- 5 Press **ENTER**. The screen displays folder names and photo files stored on the USB flash drive in a thumbnail index with the first photo or folder highlighted. A control bar appears at the bottom of the screen.

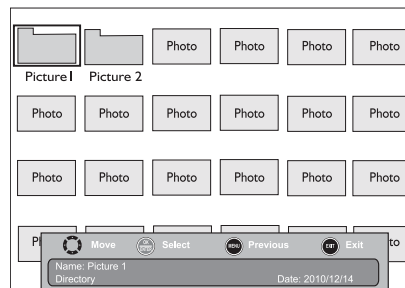

- 6 To navigate the thumbnail index screen, press:
 - **▲ ▼ ◀ ▶** to browse through the files and folders.
 - **ENTER** to view a highlighted photo full screen, or open a highlighted folder.
 - **MENU** to open the USB menu.
 - **FAV** or **FAVORITE** to add or remove a photo from the favorite photo list. A heart appears on a photo that has been added to the list.
 - **EXIT** to return to the USB menu.

When a photo is displayed full screen, a control bar appears at the bottom of the photo. The file name, picture resolution, size, and date are displayed on the bottom of the control bar. If you do not press a button within 10 seconds, the control bar closes. Press any button to open the control bar again.

- 7 To navigate the photo screen, press:
- ◀ to go to the previous photo.
 - ▶ to go to the next photo.
 - **ENTER** to rotate the photo clockwise.
 - **ZOOM** one or more times to enlarge the image by x2 or x4, or to select **Fill** (to display the photo at its actual size). You can press ▲ ▼ ◀ ▶ to pan the photo.
 - **EXIT** to return to the thumbnail index.
 - **MENU** to return to the USB menu.

Viewing your favorite photos

After you have created your favorite photo list, you can browse your favorite photos quickly.

To view your favorite photos:

- 1 Switch to USB mode (see "[Switching to USB mode](#)" on page 32).
- 2 Press **MENU**. The *USB* menu opens.

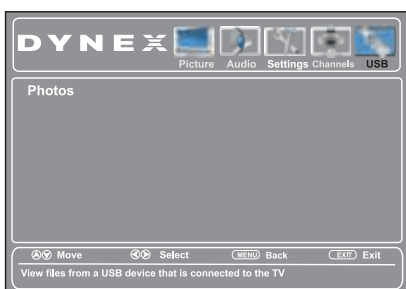

- 3 Press ▼ to access the *Photos* menu. **Photos** is highlighted.

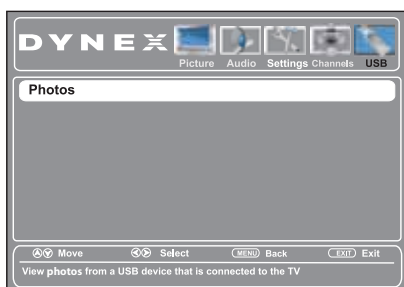

- 4 Press **ENTER** to access the *USB Photos* menu. The *USB Photos* menu opens.



- 5 Press ▲ or ▼ to highlight Favorite Photos, then press **ENTER**. A thumbnail index of your favorite photos opens with a control bar at the bottom of the screen.

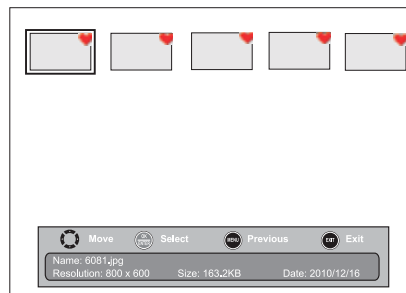

- 6 You can select photos and navigate on the photo screen the same way you browse photos. For information, see "[Browsing photos](#)" on page 32.

Viewing photos in a slideshow

To view photos in a slideshow:

- 1 Switch to USB mode (see "[Switching to USB mode](#)" on page 32).
- 2 Press **MENU**. The *USB* menu opens.

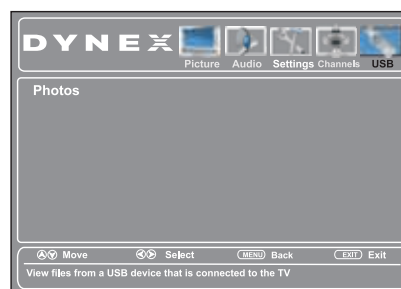

- 3 Press ▼ to access the *Photos* menu. **Photos** is highlighted.

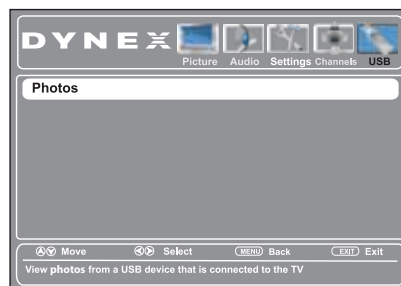

- 4 Press **ENTER** to access the *USB Photos* menu. The *USB Photos* menu opens.

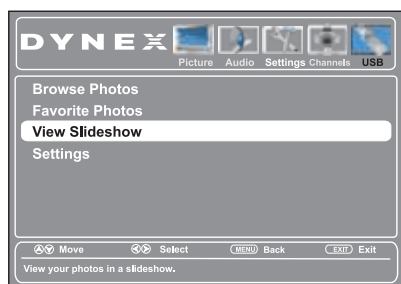

- 5 Press ▲ or ▼ to highlight **View Slideshow**, then press **ENTER**. A slideshow begins with the first photo in the current folder.

When a photo is displayed full screen, a control bar appears at the bottom of the photo. The file name, picture resolution, size, and date are displayed on the bottom of the control bar. If you do not press a button within 10 seconds, the control bar closes. Press any button to open the control bar again.



- 6 To control the slideshow, press:
- **ENTER** to pause or start the slideshow.
 - **EXIT** to exit the slideshow and return to the thumbnail index.
 - **MENU** to return to the USB menu.

Customizing slideshow settings

You can customize the slideshow settings by selecting **Repeat**, **Shuffle**, **Speed**, and **Transition** settings.

To customize slideshow settings:

- 1 Switch to USB mode (see “[Switching to USB mode](#)” on page 32).
- 2 Press **MENU**. The *USB* menu opens.

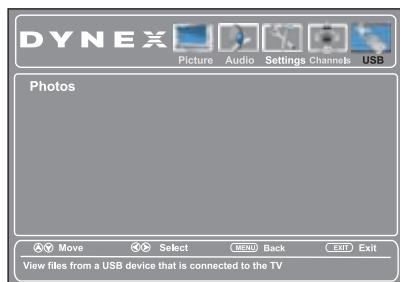

- 3 Press **▼** to access the *Photos* menu. **Photos** is highlighted.

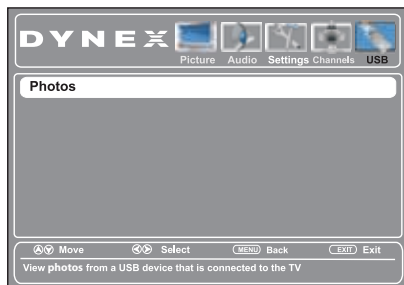

- 4 Press **ENTER** to access the *USB Photos* menu. The *USB Photos* menu opens.



- 5 Press **▲** or **▼** to highlight **Settings**, then press **ENTER**. The *USB Photos Settings* menu opens.

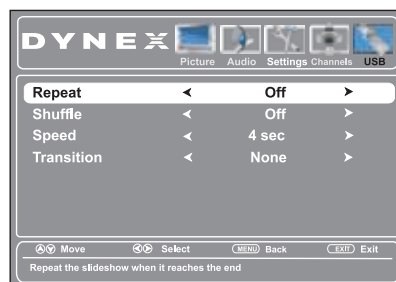

- 6 Press **▲** or **▼** to highlight an option, then press **ENTER**. You can select:
 - **Repeat**—To repeat the slideshow when it reaches the end. You can select **On** or **Off**.
 - **Shuffle**—To display the photos in random order. You can select **On** or **Off**.
 - **Speed**—To set the amount of time a photo is displayed before the next photo is shown. You can select **4 sec**, **6 sec**, or **8 sec**.
 - **Transition**—To select the way photos transition when moving to the next file in the slideshow. You can select:
 - **None**—for no transition effect.
 - **Fade to Black**—to fade the screen to black between photos.
 - **Vertical Wipe**—to wipe the screen from top to bottom between photos.
 - **Horizontal Wipe**—to wipe the screen from left to right between photos.
 - **Random**—To randomly select a transition effect.
- 7 Press **EXIT** to close the menu.

Maintaining

- Do not use your TV in areas that are too hot or too cold, because the cabinet may warp or the screen may malfunction. Your TV works best in temperatures that are comfortable to you.
- Storage temperatures are 32° to 122°F (0° to 50°C).
- Working temperatures are 41° to 104°F (5° to 40°C).
- Do not place your TV in direct sunlight or near a heat source.

Cleaning

Before cleaning the screen, unplug your TV from the power outlet.

Clean your TV with a soft, lint-free cloth. If surfaces are extremely dirty, use a soft cloth dampened with a weak detergent solution.

Use an eyeglass cleaner to clean the screen. Never use alcohol, paint thinner, or benzine.

Before using a chemically treated cloth, read the instructions that came with the cloth.

Do not spray insecticide liquid near your TV. Such chemicals may cause damage and discoloration to the exposed surfaces.

Servicing

Do not try to repair your TV yourself. There are no user-serviceable parts inside. Turn off your TV, unplug the power cord, then contact an authorized service center.

Troubleshooting

Warning

Do not try to repair your TV yourself. Contact authorized service personnel.

Video and audio

Problem	Solution
Picture does not fill the screen. There are black bars around the picture.	<ul style="list-style-type: none"> Change the aspect ratio. An increasing amount of digital TV and movies are presented in wide screen (16:9). See "Adjusting the TV picture" on page 20.
No picture (screen is not lit) and no sound.	<ul style="list-style-type: none"> Press ⏻ on the TV or the remote control. Make sure that the video cables are connected securely to the back of your TV. Adjust the contrast and brightness. See "Adjusting the TV picture" on page 20. Make sure that the power cord is plugged in. Make sure that the correct video input source is selected. See "Selecting the video input source" on page 19. Try another channel. The station may be experiencing problems. Make sure that the incoming signal is compatible. Make sure the antenna or cable TV is connected correctly and securely. See "Connecting a cable or satellite box" on page 9 or "Connecting an antenna or cable TV (no box)" on page 11. Check the closed caption settings. Some TEXT modes can block the screen.
Picture quality is good on some channels and poor on others. Sound is good.	<ul style="list-style-type: none"> The problem may be caused by a poor or weak signal from the broadcaster or cable TV provider. If you connect to cable or satellite TV without a set-top box and experience poor picture quality, you may need to install a set-top box to improve signal reception and picture quality. Contact your cable or satellite TV provider about upgrading to a set-top box.

Problem	Solution
Dark, poor, or no picture (screen is lit), but sound is good.	<ul style="list-style-type: none"> Try another channel. The station may be experiencing problems. Make sure that the antenna or cable TV is connected correctly and securely. See "Connecting a cable or satellite box" on page 9 or "Connecting an antenna or cable TV (no box)" on page 11. Make sure that Audio Only option is set to Off. See "Playing TV audio only" on page 22. Adjust the brightness. See "Adjusting the TV picture" on page 20. Make sure that the correct picture mode is selected. See "Adjusting the TV picture" on page 20. If you are using an antenna, the digital channel signal may be low. To check the digital channel signal strength, see "Checking the digital signal strength" on page 25. If you are using an antenna and the signal strength is low, adjust the antenna or use a highly directional outdoor antenna or set-top antenna with a built-in amplifier. Make sure that the video cables are connected securely to the back of your TV. The video cable(s) you are using may be bad. Try a new set.
No color, dark picture, or color is not correct.	<ul style="list-style-type: none"> Try another channel. The station may be experiencing problems. Adjust the color saturation. See "Adjusting the TV picture" on page 20. Make sure that the video cables are connected correctly and securely to the back of your TV. Make sure that the antenna or cable TV is connected correctly and securely. See "Connecting a cable or satellite box" on page 9 or "Connecting an antenna or cable TV (no box)" on page 11. If you are using an antenna, the digital channel signal may be low. To check the digital channel signal strength, see "Checking the digital signal strength" on page 25. If you are using an antenna and the signal strength is low, adjust the antenna or use a highly directional outdoor antenna or set-top antenna with a built-in amplifier.
Only snow (noise) appears on the screen.	<ul style="list-style-type: none"> Try another channel. The station may be experiencing problems. Make sure that the antenna or cable TV is connected correctly and securely. See "Connecting a cable or satellite box" on page 9 or "Connecting an antenna or cable TV (no box)" on page 11. If you are using an antenna, the digital channel signal may be low. To check the digital channel signal strength, see "Checking the digital signal strength" on page 25. If you are using an antenna and the signal strength is low, adjust the antenna or use a highly directional outdoor antenna or set-top antenna with a built-in amplifier.

Problem	Solution
Dotted lines or stripes appear on the screen.	<ul style="list-style-type: none"> Make sure that the antenna or cable TV is connected correctly and securely. See “Connecting a cable or satellite box” on page 9 or “Connecting an antenna or cable TV (no box)” on page 11. If you are using an antenna, the digital channel signal may be low. To check the digital channel signal strength, see “Checking the digital signal strength” on page 25. If you are using an antenna and the signal strength is low, adjust the antenna or use a highly directional outdoor antenna or set-top antenna with a built-in amplifier. Make sure that the video cables are connected securely to the back of your TV. The video cable(s) you are using may be bad. Try a new set. Other devices (for example, surround sound receiver, external speakers, fans, or hair dryers) may be interfering with your TV. Try turning off one device at a time to determine which device is causing interference. After you have determined which device is causing interference, move it further from the TV to eliminate the interference.
Double images.	<ul style="list-style-type: none"> Use a highly directional outdoor antenna, cable TV, or satellite TV.
The picture has a few bright or dark spots.	<ul style="list-style-type: none"> A few bright or dark spots on an LCD screen is normal. It does not affect the operation of this TV.
Good picture, but no sound.	<ul style="list-style-type: none"> Increase the volume. Unplug the headphones. Make sure that the sound is not muted. Make sure that the correct audio mode is selected. Make sure that the audio cables are connected correctly and securely to the back of your TV. Make sure that the antenna or cable TV is connected correctly and securely. See “Connecting a cable or satellite box” on page 9 or “Connecting an antenna or cable TV (no box)” on page 11. If you are using an antenna, the digital channel signal may be low. To check the digital channel signal strength, see “Checking the digital signal strength” on page 25. The audio cable(s) you are using may be bad. Try a new set.
Poor picture	<ul style="list-style-type: none"> Make sure that the room is not too bright. Light reflecting off the screen can make the picture difficult to see. If an S-VHS camera or a camcorder is connected while another connected device is turned on, the picture may be poor. Turn off one or more devices.
Good sound but poor color	<ul style="list-style-type: none"> Adjust the contrast, color, and brightness settings.
Audio noise	<ul style="list-style-type: none"> Other devices (for example, surround sound receiver, external speakers, fans, or hair dryers) may be interfering with your TV. Try turning off one device at a time to determine which device is causing interference. After you have determined which device is causing interference, move it further from the TV to eliminate the interference.

Problem	Solution
No output from one of the speakers	<ul style="list-style-type: none"> Adjust the audio balance. See “Adjusting sound settings” on page 22. Make sure that the audio cables are connected correctly and securely to the back of your TV.
After images appear	<ul style="list-style-type: none"> Do not display a still image, such as a logo, game, or computer image, for an extended period of time. This can cause a permanent after-image to be burned into the screen. This type of damage is not covered by your warranty.

Remote control

Problem	Solution
Remote control does not work.	<ul style="list-style-type: none"> Make sure that the power cord is correctly connected to your TV and a power outlet. Make sure that there are no obstructions between the remote control and the remote control sensor on the front of the TV. Point the remote control directly at the remote control sensor on your TV. For the location of the remote control sensor, see “Front” on page 5. Make sure that the batteries are installed correctly. See “Installing remote control batteries” on page 17. Replace dead batteries with new batteries. See “Installing remote control batteries” on page 17.
Trouble programming your existing universal remote control.	<ul style="list-style-type: none"> See instructions and a table of common codes in “Programming a different universal remote control” on page 38. Codes are subject to change. For up-to-date codes, go to www.dynexproducts.com/remotecodes. Replace dead batteries with new batteries. See “Installing remote control batteries” on page 17. Refer to the User Guide that accompanied your universal remote control and contact the manufacturer if problems persist.

General

Problem	Solution
No power	<ul style="list-style-type: none"> Make sure that the power cord is correctly connected to your TV and a power outlet. Unplug the power cord, wait 60 seconds, then plug the cord back in and turn on your TV. Other devices (for example, surround sound receiver, external speakers, fans, or hair dryers) may be interfering with your TV. Try turning off one device at a time to determine which device is causing interference. After you have determined which device is causing interference, move it further from the TV to eliminate the interference.
“No signal” error message is displayed	<ul style="list-style-type: none"> Press INPUT and make sure that you have selected the correct input for the device or service you are trying to use. If you are using a cable or satellite box, use the remote that came with that box to change channels.

Problem	Solution
After Auto Channel Search, there are no channels	<ul style="list-style-type: none"> Reception can vary by channel depending on the broadcast power level of a given station. Contact your cable or satellite TV provider. Make sure the antenna or cable/satellite box is connected securely to your TV. Try replacing the cable between the antenna/cable or cable/satellite box and your TV.
One or more channels do not display.	<ul style="list-style-type: none"> Make sure that the channels are not blocked. See "Setting parental control levels" on page 26. Make sure that the channels are not hidden. The channel may have been deleted from the channel list. You can tune to the channel by pressing the number buttons or you can add the channel back to the channel list. See "Hiding channels" on page 23. If you are using a cable or satellite box, use the remote that came with that box to change channels. Make sure you have the correct input selected to view channels from the cable or satellite box. If you are using an antenna, the digital channel signal may be low. To check the digital channel signal strength, see "Checking the digital signal strength" on page 25.
Password is lost.	<ul style="list-style-type: none"> Enter 9999 to access parental controls, then set a new password. See "Setting or changing the password" on page 25.
Some settings cannot be accessed.	<ul style="list-style-type: none"> If a setting is grayed, the setting is not available in the current video input mode.
TV cabinet creaks.	<ul style="list-style-type: none"> When the TV is in use, the temperature rises naturally and may cause the cabinet to expand or contract which can cause a creaking noise. This is not a malfunction.
Control buttons do not work	<ul style="list-style-type: none"> Make sure that the Button Lock option is set to No. See "Locking control buttons" on page 26. Unplug the power cord, wait a few seconds, then plug the cord back in and turn on your TV.
TV keeps turning off	<ul style="list-style-type: none"> Make sure that the sleep timer is not turned on. See "Setting the sleep timer" on page 30.

Note
If the problem is not solved by using these troubleshooting instructions, turn off your TV, then turn it on again.

Specifications

Specifications are subject to change without notice.

Warranty

DX-32L100A13
Parts: 1 year
Labor: 1 year

Dimensions and weight

DX-32L100A13
Without stand: 31.0 × 4.4 × 19.5 in. (78.65 × 11.09 × 49.55 cm)
With stand: 31.0 × 9.1 × 21.5 in. (78.65 × 23.18 × 54.65 cm)
Without stand: 18.01 lbs. (8.2 kg)
With stand: 19.41 lbs. (8.6 kg)

Screen

DX-32L100A13	
Screen size measured diagonally	31.5"
Display type	LCD
Panel 60 Hz vs. 120 Hz	60Hz
Display resolution	720p
Panel resolution	1366 (H) × 768 (V)
Aspect ratio	16:9
Contrast ratio (typical)–panel	3000:1
Dynamic contrast ratio - list value	6000:1
Brightness (center typical) cd/m2	300 nits
Comb filter	3d y/c digital
Response time	8 ms
Horizontal viewing angle	160
Vertical viewing angle	160

Display resolutions/VGA scan rates

DX-32L100A13	
HDMI 1.3	Suggested Resolutions: 1080p, 1080i, 720p, 480p, 480i
Component video	Suggested Resolutions: 1080i, 720p, 480p, 480i
PC/VGA	Suggested scan rates: 640 × 480/60Hz, 800 × 600/60Hz, 1024 × 768/60Hz, 1360 × 768/60Hz

Tuner

DX-32L100A13	
Analog	NTSC
Digital	ATSC, 8-VSB, Clear-QAM

Inputs

DX-32L100A13	
HDMI/DVI	3 (side) E-EDID compliant HDCP compliant DVI to HDMI only
Component video	1 (side)
Composite video	1 (side)
Shared audio (component and composite)	No
S-Video	No
PC/VGA	1 (side)
3.5mm PC audio input	1 (side)
USB	1 (side) Supports JPEG and firmware upgrade

Outputs

DX-32L100A13	
Video	No
Analog audio	1 (side)
Digital audio	1 Coaxial (side)
WiFi	No
Ethernet	No
Headphone	1 (side)

Audio

DX-32L100A13	
Watts/Channel	6W
Number of Speakers	2

Power

DX-32L100A13	
Power consumption	On: 90 W Standby: <1 W
Power input	120V/60Hz

Miscellaneous

DX-32L100A13	
OSD languages	English, French, Spanish
INlink	No
Game Mode	No
ENERGY STAR qualified	No
Internet connectable	No
TV base screws	M4 type (16 mm length) (6 pcs)
V-Chip (version 2.0)	Yes
Sleep timer	Yes
Channel labeling	No
VESA mount (mm) (horizontal × vertical)	200 × 200

Note

The length of the wall-mount screws vary depending on the wall-mount bracket you purchased. See the instructions that came with the wall-mount bracket for screw lengths.

Programming universal remote controls

Programming a different universal remote control

You can operate your Dynex TV with a new or existing universal remote control.

To program a different universal remote control:

- 1 See the table below for common codes. If you have problems programming your remote or need a different remote control code, visit www.dynexproducts.com/remotecodes for the latest remote control code information.
- 2 Follow your universal remote control's instructions to enter the TV code you found in Step 1.

Tips

- If your universal remote control has a code search feature, run a code search to identify a code that matches your TV. See your universal remote control's instructions for details.
- If your universal remote control has a "Learn" feature, you can manually program it using the Dynex TV remote to "teach" the commands one at a time. See your universal remote control's instructions for details.

For additional help and information...

1. Visit <http://www.dynexproducts.com/remotecodes>
2. Call technical support for the universal remote control or cable/satellite company of the remote/set-top box you are trying to program.
3. Call the Dynex Customer Care Center 1-800-305-2204

Common universal remote control codes

Notes

- This note only goes with TV/Blu-ray or TVs.
- The following codes may not provide full functionality. You may need to use the remote control that came with your TV, especially to control the Blu-ray or DVD functions.

The following is a list of the most common remote control codes. Codes for other remote controls are available online at: www.dynexproducts.com/remotecodes, or check with your cable or satellite TV provider for the remote control code.

Dynex TV codes for universal remote controls (for all Dynex TVs manufactured after Jan. 1, 2007)

Universal remote control makes and models	
One for All	0054
Phillips	0198, 0490
RCA	135
Sony	068, 069, 078, 096, 100, 164, 168, 229, 026

Set-top box makes and models	
Cablevision	068, 069, 078, 096, 100, 164, 168, 229, 026
Charter	2002, 1204, 1423, 1517, 0171, 1963, 0463, 1463, 0842, 1326, 167, 415, 424, 450, 456, 461, 507, 523, 567, 577, 586
Comcast	10171, 11204, 11326, 11463, 11517, 11641, 11780, 11785, 11892, 11963, 12002
Cox	1326, 1463
DirectTV	10171, 11204, 11326, 11517, 11564, 11641, 11963, 12002
Dish Network	720
Time Warner	400, 450, 461, 456, 11463, 1463, 0463
TiVo	0091
Verizon	0198, 0490

Tips

- The brand name is often visible on the front of the universal remote control, and the model number is often visible on the back.
- If your universal remote control isn't listed on the chart, refer to your universal remote control's instructions and try codes for the brands Orion, Emerson, Memorex, Sansui, Sylvania, or Zenith. You may need to try several codes before finding a match.

Legal notices

FCC Part 15

This device complies with Part 15 of the FCC Rules. Operation of this product is subject to the following two conditions: (1) this device may not cause harmful interference, and (2) this device must accept any interference received, including interference that may cause undesired operation.

This equipment has been tested and found to comply within the limits for a class B digital device, pursuant to Part 15 of the FCC Rules. These limits are designed to provide reasonable protection against harmful interference in a residential installation. This equipment generates, uses, and can radiate radio frequency energy and, if not installed and used in accordance with the instructions, may cause harmful interference to radio communications. However, there is no guarantee that interference will not occur in a particular installation. If this equipment does cause harmful interference to radio or television reception, which can be determined by turning the equipment off and on, the user is encouraged to try to correct the interference by one or more of the following measures:

- Reorient or relocate the receiving antenna.
- Increase the separation between the equipment and receiver.
- Connect the equipment into an outlet on a circuit different from that to which the receiver is connected.
- Consult the dealer or an experienced technician for help.

FCC warning

Changes or modifications not expressly approved by the party responsible for compliance with the FCC Rules could void the user's authority to operate this equipment.

Cables

Connections to this device must be made with shielded cables with metallic RF/EMI connector hoods to maintain compliance with FCC Rules and Regulations.

Canada ICES-003 statement

This Class B digital apparatus complies with Canadian ICES-003. Cet appareil numérique de la classe B est conforme à la norme NMB-003 du Canada.

Standard Television Receiving Apparatus — Appareil de réception télévision ordinaire, Canada BETS-7 / NTMR-7

HDMI



The terms HDMI and HDMI High-Definition Multimedia Interface, and the HDMI Logo are trademarks or registered trademarks of HDMI Licensing LLC in the United States and other countries.

Dolby Laboratories



Dolby, Pro Logic, and the double-D symbol are trademarks of Dolby Laboratories.

One-year limited warranty - Dynex Televisions

Definitions:

Dynex Products ("Dynex") warrants to you, the original purchaser of this new Dynex-branded television ("Product"), that the Product shall be free of defects in the original manufacturer of the material or workmanship for a period of one (1) year from the date of your purchase of the Product ("Warranty Period"). For this warranty to apply, your Product must be purchased in the United States or Canada from a Best Buy or Future Shop authorized dealer of Dynex brand products only that are packaged with this warranty statement.

How long does the coverage last?

The Warranty Period lasts for 1 year (365 days) from the date you purchased the Product. Your purchase date is printed on the receipt you received with the Product.

What does this warranty cover?

During the Warranty Period, if the original manufacture of the material or workmanship of the Product is determined to be defective by an authorized Dynex repair center or store personnel, Dynex will (at its sole option): (1) repair the Product with new or rebuilt parts; or (2) replace the Product at no charge with new or rebuilt comparable products or parts. Products and parts replaced under this warranty become the property of Dynex and are not returned to you. If service of Products or parts are required after the Warranty Period expires, you must pay all labor and parts charges. This warranty lasts as long as you own your Dynex Product during the Warranty Period. Warranty coverage terminates if you sell or otherwise transfer the Product.

How to obtain warranty service?

If you purchased the Product at a Best Buy or Future Shop retail store location and your television Product has a screen size of less than 42 inches, please take your original receipt and the Product to any Best Buy or Future Shop store. Make sure that you place the Product in its original packaging or packaging that provides the same amount of protection as the original packaging. If you purchased the Product from a Best Buy or Future Shop online web site, mail your original receipt and the Product to the address listed on the web site. Make sure that you put the Product in its original packaging or packaging that provides the same amount of protection as the original packaging.

To obtain in-home warranty service for a television with a screen 42 inches or larger, in the United States call 1-888-BESTBUY, Canada call 1-866-BESTBUY for Future Shop call 1-800-663-2275. Call agents will diagnose and correct the issue over the phone or will have an Insignia-approved repair technician dispatched to your home.

Where is the warranty valid?

This warranty is valid only in the United States and Canada at Best Buy or Future Shop branded retail stores or websites to the original purchaser of the product in the county where the original purchase was made.

What does the warranty not cover?

This warranty does not cover:

- Customer instruction/education
- Installation
- Set up adjustments
- Cosmetic damage
- Damage due to acts of God, such as power surges
- Accident(s)
- Misuse
- Abuse
- Negligence
- Commercial purposes/use, including but not limited to use in a place of business or in communal areas of a multiple dwelling condominium or apartment complex, or otherwise used in a place of other than a private home.
- Modification of any part of the Product, including the antenna
- Plasma display panel damaged by static (non-moving) images applied for lengthy periods (burn-in).
- Damage due to incorrect operation or maintenance
- Connection to an incorrect voltage or power supply
- Attempted repair by any person not authorized by Dynex to service the Product
- Products sold "as is" or "with all faults"
- Consumables, including but not limited to batteries (i.e. AA, AAA, C etc.)
- Products where the factory applied serial number has been altered or removed
- Loss or Theft of this product or any part of the product

- Up to three (3) pixel failures (dots that are dark or incorrectly illuminated) grouped in an area smaller than one tenth (1/10) of the display size or up to five (5) pixel failures throughout the display. (Pixel based displays may contain a limited number of pixels that may not function normally.)
- Failures or Damage caused by any contact including but not limited to liquids, gels or pastes.

REPAIR REPLACEMENT AS PROVIDED UNDER THIS WARRANTY IS YOUR EXCLUSIVE REMEDY FOR BREACH OF WARRANTY. DYNEX SHALL NOT BE LIABLE FOR ANY INCIDENTAL OR CONSEQUENTIAL DAMAGES FOR THE BREACH OF ANY EXPRESS OR IMPLIED WARRANTY ON THIS PRODUCT, INCLUDING, BUT NOT LIMITED TO, LOST DATA, LOSS OF USE OF YOUR PRODUCT, LOST BUSINESS OR LOST PROFITS. DYNEX PRODUCTS MAKES NO OTHER EXPRESS WARRANTIES WITH RESPECT TO THE PRODUCT, ALL EXPRESS AND IMPLIED WARRANTIES FOR THE PRODUCT, INCLUDING, BUT NOT LIMITED TO, ANY IMPLIED WARRANTIES OF AND CONDITIONS OF MERCHANTABILITY AND FITNESS FOR A PARTICULAR PURPOSE, ARE LIMITED IN DURATION TO THE WARRANTY PERIOD SET FORTH ABOVE AND NO WARRANTIES, WHETHER EXPRESS OR IMPLIED, WILL APPLY AFTER THE WARRANTY PERIOD. SOME STATES, PROVINCES AND JURISDICTIONS DO NOT ALLOW LIMITATIONS ON HOW LONG AN IMPLIED WARRANTY LASTS, SO THE ABOVE LIMITATION MAY NOT APPLY TO YOU. THIS WARRANTY GIVES YOU SPECIFIC LEGAL RIGHTS, AND YOU MAY ALSO HAVE OTHER RIGHTS, WHICH VARY FROM STATE TO STATE OR PROVINCE TO PROVINCE.

Contact Dynex:

For customer service please call 1-800-305-2204

www.dynexproducts.com

Distributed by Best Buy Purchasing, LLC

7601 Penn Avenue South, Richfield, Minnesota, U.S.A. 55423-3645

© 2012 BBY Solutions, Inc.

All rights reserved. DYNEX is a trademark of BBY Solutions, Inc. Registered in some countries. All other products and brand names are trademarks of their respective owners.

DYNEX™

www.dynexproducts.com
US and Canada Market - (800) 305-2204

Distributed by Best Buy Purchasing, LLC
7601 Penn Ave. South, Richfield, MN 55423 U.S.A.
© 2012 BBY Solutions, Inc. All rights reserved.

DYNEX is a trademark of BBY Solutions, Inc. Registered in some countries. All other products and brand names are trademarks of their respective owners.

ENGLISH
12-0956