

SONY®



Table of
contents

Operation
Search

MENU/Settings
Search

Index

Cyber-shot

Cyber-shot Handbook

DSC-W320/W330

How to use this handbook

Click on a button at upper right to jump to the corresponding page.
This is convenient when searching for a function you want to view.



← Search for information by function.

← Search for information by operation.

← Search for information in a listing of MENU/Settings items.

← Search for information by keyword.

Table of contents

Operation Search

MENU/Settings Search

Index

Marks and notations used in this handbook

In this handbook, the sequence of operations is shown by arrows (→). Operate the camera in the order indicated. Marks are shown as they appear in the camera's default setting.

The default setting is indicated by ✓.

Indicates cautions and limitations relevant to the correct operation of the camera.

Indicates information that is useful to know.

Red Eye Reduction

The flash strobos two or more times before shooting to reduce the red-eye phenomenon when using the flash.

- 1 Set the camera to shooting mode.
- 2 MENU → (Settings) → (Shooting Settings) → [Red Eye Reduction] → desired mode → on the control button

<input checked="" type="checkbox"/>	Auto	When the Face Detection function is activated, the flash strobos automatically to reduce the red-eye phenomenon.
<input type="checkbox"/>	On	The flash always strobos to reduce the red-eye phenomenon.
<input type="checkbox"/>	Off	Does not use Red Eye Reduction.

Notes

- To avoid blurring of images, hold the camera firmly until the shutter is released. It usually takes a second after you press the shutter button. Be also sure not to allow the subject to move during this period.
- Red Eye Reduction may not produce the desired effects. It depends on individual differences and conditions, such as distance to the subject, or if the subject looked away from the pre-strobe.
- If you do not use the Face Detection function, Red Eye Reduction does not work, even when you select [Auto].

What causes the red-eye phenomenon?

Pupils become dilated in dark environments. Flash light is reflected off the blood vessels at the back of the eye (retina), causing the "red-eye" phenomenon.

Other ways to reduce red-eye

- Select (High Sensitivity) mode in Scene Selection. (The flash is set to [Off] automatically.)
- When the eyes of the subject turn out red, correct the image with [Retouch] → [Red Eye Correction] on the viewing menu or with the supplied software "PMB".

Notes on using the camera

Notes on the types of memory card that you can use (sold separately)

The following memory cards are compatible with this camera: “Memory Stick PRO Duo” media, “Memory Stick PRO-HG Duo” media, “Memory Stick Duo” media, SD memory cards and SDHC memory cards. MultiMediaCard is not compatible.

Memory cards with a capacity up to 32 GB have been confirmed to operate properly with the camera.

In this Handbook, “Memory Stick PRO Duo” media, “Memory Stick PRO-HG Duo” media and “Memory Stick Duo” media are collectively referred to as “Memory Stick Duo” media.

When recording movies, it is recommended that you use the following memory cards:

- MEMORY STICK PRO DUO (“Memory Stick PRO Duo” media)
- MEMORY STICK PRO-HG DUO (“Memory Stick PRO-HG Duo” media)
- SD memory card or SDHC memory card (Class 2 or faster)

For details on “Memory Stick Duo” media, see page 99.

When using a “Memory Stick Duo” media with standard sized “Memory Stick” media slot

You can use the “Memory Stick Duo” media by inserting it into the “Memory Stick Duo” media Adaptor (sold separately).



“Memory Stick Duo” media
Adaptor

Notes on the battery pack

- Charge the battery pack (supplied) before using the camera for the first time.
- You can charge the battery pack even if it is not completely discharged. In addition, even if the battery pack is not fully charged, you can use the partially charged capacity of the battery pack as is.

- If you do not intend to use the battery pack for a long time, use up the existing charge and remove it from the camera, then store it in a cool, dry place. This is to maintain the battery pack functions.
- For details on the usable battery pack, see page 101.

Carl Zeiss lens

The camera is equipped with a Carl Zeiss lens which is capable of reproducing sharp images with excellent contrast. The lens for the camera has been produced under a quality assurance system certified by Carl Zeiss in accordance with the quality standards of Carl Zeiss in Germany.

Notes on the LCD screen and lens

- The LCD screen is manufactured using extremely high-precision technology so over 99.99% of the pixels are operational for effective use. However, some tiny black and/or bright dots (white, red, blue or green) may appear on the LCD screen. These dots are a normal result of the manufacturing process and do not affect the recording.

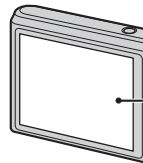

Black, white, red, blue or green dots

- Exposing the LCD screen or the lens to direct sunlight for long periods may cause malfunctions. Be careful when placing the camera near a window or outdoors.
- Do not press against the LCD screen. The screen may be discolored and that may cause a malfunction.
- Images may trail across on the LCD screen in a cold location. This is not a malfunction.
- Be careful not to bump the movable lens, and be careful not to apply force to it.

On moisture condensation

- If the camera is brought directly from a cold to a warm location, moisture may condense inside or outside the camera. This moisture condensation may cause a malfunction of the camera.
- If moisture condensation occurs, turn off the camera and wait about an hour for the moisture to evaporate. Note that if you attempt to shoot with moisture remaining inside the lens, you will be unable to record clear images.

The images used in this Handbook

The images used as examples in this Handbook are reproduced images, and are not actual images shot using this camera.

On Illustrations

Illustrations used in this Handbook are of the DSC-W320 unless noted otherwise.

Table of
contents

Operation
Search

MENU/Settings
Search

Index

Table of contents

Notes on using the camera

How to use this handbook	2
Notes on using the camera	3
Operation Search	8
MENU/Settings Search	10
Identifying parts	13
List of icons displayed on the screen	14
Using the mode switch	16
Using the internal memory	17

Shooting

Zoom	18
DISP (Screen Display Settings)	19
Flash	20
Smile Shutter	21
Self-Timer	22

Viewing

Viewing still images	23
Playback zoom	24
Image Index	25
Delete	26
Viewing movies	27

MENU (Shooting)

MENU items (Shooting)	10
-----------------------------	----

MENU (Viewing)

MENU items (Viewing)	11
----------------------------	----

Settings

Setting items	12
---------------------	----

TV

Viewing images on a TV	77
------------------------------	----

Computer

Using with your computer	79
Using the software	80
Connecting the camera to the computer	82
Uploading images to a media service	84

Printing

Printing still images	86
-----------------------------	----

Troubleshooting

Troubleshooting	88
Warning indicators and messages	96

Others

“Memory Stick Duo” media	99
Battery pack	101
Battery charger	102

Index

Index 103

Table of contents

Operation Search

MENU/Settings Search

Index

Operation Search

Table of
contents

Operation
Search

MENU/Settings
Search

Index

Leaving the settings to the camera	Intelligent Auto Adjustment.....	29
	Scene Selection.....	31
	Scene Recognition.....	45
Shooting portraits	Soft Snap.....	31
	Twilight Portrait.....	31
	Smile Shutter.....	21
	Scene Recognition.....	45
	Face Detection.....	48
	Red Eye Reduction.....	61
Shooting best shots of your pet	Pet.....	31
Shooting moving objects	Movie.....	16
	Burst Settings.....	37
Shooting without blur	SteadyShot.....	33
	High Sensitivity.....	31
	2-second delay self-timer.....	22
	ISO.....	39
Shooting with backlight	Forced Flash.....	20
	Scene Recognition.....	45
	DRO.....	50
Shooting in dark places	High Sensitivity.....	31
	Slow Synchro.....	20
	ISO.....	39
Adjusting exposure	EV.....	38

Changing focus position	Focus	42
	Face Detection	48
Changing image size	Image Size.....	35
Deleting images	Delete.....	26, 54
	Format	70
Displaying enlarged images	Playback zoom.....	24
	Trimming	53
Editing images	Retouch	53
Playing back a series of images in order	Slideshow	52
Shooting/Viewing with easy-to-see indicators	Easy Mode.....	34, 51
Printing images with the date	Using the “PMB (Picture Motion Browser)”	80
Changing clock settings	Date & Time Setting.....	76
Initializing settings	Initialize.....	66
Printing images	Print	86
Viewing on TVs	Viewing images on a TV.....	77

MENU/Settings Search







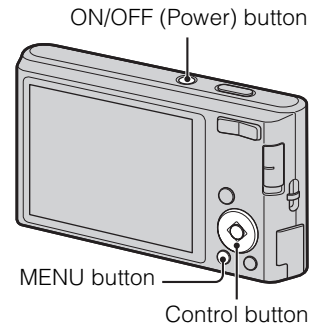

















MENU items (Shooting)

You can select the various shooting functions easily from the MENU button.

- 1 Press the ON/OFF (Power) button and set the camera to shooting mode.
- 2 Press the MENU button to display the Menu screen.
- 3 Select the desired menu item with ▲/▼/◀/▶ on the control button.
- 4 Press the MENU button to turn off the Menu screen.



In the table below, ✓ indicates a user-changeable function, while — indicates an unchangeable one. The icons below [SCN] indicate the changeable modes. Depending on the recording mode, function settings may be fixed or limited. For details, see the page of each item.







Mode switch Menu items						
	REC Mode		P	SCN		
REC Mode	✓	✓	✓	✓	✓	—
Scene Selection	—	—	✓	—	—	—
Easy Mode	✓	✓	✓	✓	✓	—
Image Size	✓	✓	✓	✓	✓	✓
Burst Settings	✓	✓	    	—	—	
EV	✓	✓	✓	✓	✓	✓
ISO	—	✓		—	—	
White Balance	—	✓	  	✓	✓	
Underwater White Balance	—	—		—	—	
Focus	—	✓	—	—	—	
Metering Mode	—	✓	—	—	✓	
Scene Recognition	✓	—	—	—	—	
Smile Detection Sensitivity	✓	✓	    	✓	—	
Face Detection	✓	✓	   	✓	—	
DRO	—	✓	—	—	—	
 (Settings)	✓	✓	✓	✓	✓	

Note

- Only the items that are available for each mode are displayed on the screen.







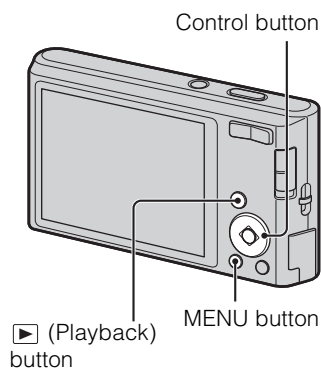

MENU items (Viewing)

You can select the various viewing functions easily from the MENU button.

- 1 Press the  (Playback) button to switch to playback mode.
- 2 Press the MENU button to display the Menu screen.
- 3 Select the desired menu item with /// on the control button.
- 4 Press  on the center of the control button.



In the table below, ✓ indicates a user-changeable function, while — indicates an unchangeable one.









Menu items	Memory card	Internal Memory
EASY (Easy Mode)	✓	✓
 (Slideshow)	✓	✓
 (Retouch)	✓	✓
 (Delete)	✓	✓
 (Protect)	✓	✓
DPOF	✓	—
 (Print)	✓	✓
 (Rotate)	✓	✓
 (Select Folder)	✓	—
 (Settings)	✓	✓

Note





- Only the items that are available for each mode are displayed on the screen.

Setting items

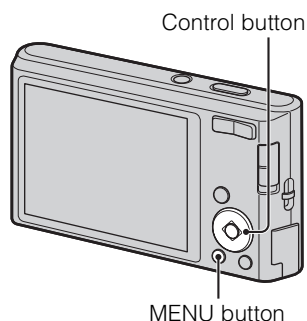
You can change the settings on the  (Settings) screen.

- 1 Press the MENU button to display the Menu screen.
- 2 Select  (Settings) with  on the control button, then press  on the center of the control button to display the setup screen.
- 3 Select the desired category with /, then press  to select each item, then press .
- 4 Select the desired setting, then press .



Categories	Items
 Shooting Settings	Grid Line
	Digital Zoom
	Red Eye Reduction
 Main Settings	Beep
	Language Setting
	Function Guide
	Power Save
	Initialize
	Video Out
	USB Connect
	LUN Settings
 Memory Card Tool	Format
	Create REC.Folder
	Change REC.Folder
	Delete REC.Folder
	Copy
	File Number
 Internal Memory Tool	Format
	File Number
 Clock Settings	Date & Time Setting

Notes

- [Shooting Settings] appears only when settings have been entered from shooting mode.
- [Memory Card Tool] appears only when a memory card is inserted in the camera, while [Internal Memory Tool] appears only when a memory card is not inserted.

Identifying parts

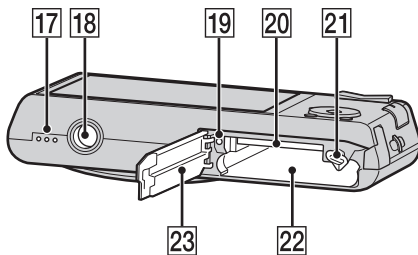
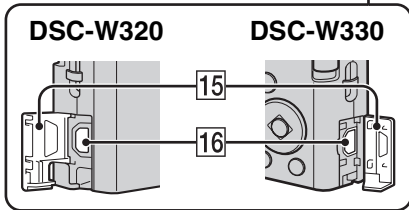
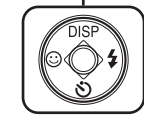
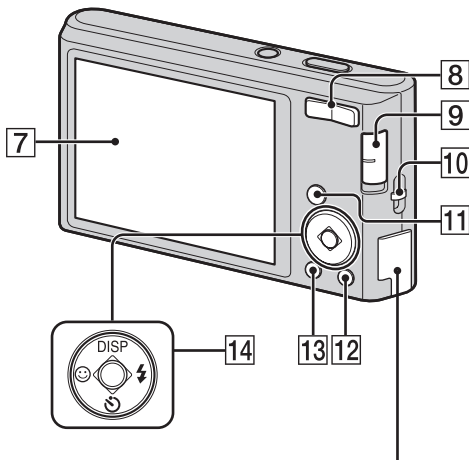
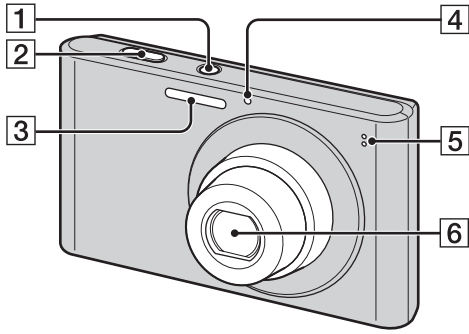

- 1 ON/OFF (Power) button
- 2 Shutter button
- 3 Flash
- 4 Self-timer lamp/Smile Shutter lamp
- 5 Microphone
- 6 Lens
- 7 LCD screen
- 8 For shooting: W/T (zoom) button (18)
For viewing: Q (Playback zoom) button/
☒ (Index) button (24, 25)
- 9 Mode switch (16)
- 10 Hook for wrist strap*
- 11 ▶ (Playback) button (23)
- 12 🗑 (Delete) button (26)
- 13 MENU button (10)
- 14 Control button
Menu on: ▲/▼/◀/▶/●
Menu off: DISP/☺/☹/⚡
- 15 Terminal cover
- 16 ⚡ (USB)/A/V OUT jack
- 17 Speaker
- 18 Tripod receptacle
- 19 Access lamp
- 20 Memory card slot
- 21 Battery eject lever
- 22 Battery insertion slot
- 23 Battery/Memory card cover

* Using the wrist strap

The wrist strap is already attached to the camera at the factory. Place your hand through the loop to prevent the camera from damage by being dropped.

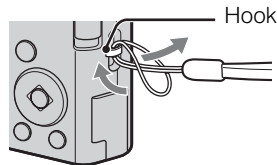

2

Display	Indication
●	AE/AF lock
ISO400	ISO number
NR	NR slow shutter
125	Shutter speed
F3.5	Aperture value
+2.0EV	Exposure Value
	AF range finder frame indicator
REC Standby	Recording a movie/Movie standby
0:12	Recording time (m:s)
101-0012	Folder-file number
2010 11 9:30 AM	Recorded date/time of the playback image
● STOP ● PLAY	Function guide for playing image
◀▶ BACK/NEXT	Selecting images
▼ VOLUME	Adjusting volume

3

Display	Indication
	Recording folder
	Playback folder
96	Number of recordable images
12/12	Image number/Number of images recorded in selected folder
100Min	Recordable time
	Recording/Playback Media (memory card, internal memory)
	Changing folder
	Red-eye reduction
	Metering mode
	Flash mode
	Flash charging
AWB	White balance
ISO400	ISO number

4

Display	Indication
	Self-timer
C:32:00	Self-diagnosis display
	Overheating warning
	Face Detection
	Burst Settings
	AF range finder frame
+	Spot metering cross hair
+2.0EV	Exposure value
500	Shutter speed
F3.5	Aperture value
	Playback
	Playback bar
00:00:12	Counter
	Volume

Table of contents

Operation Search



MENU/Settings Search

Index

Using the mode switch

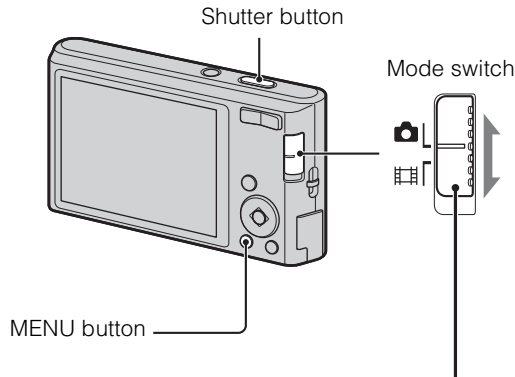
Set the mode switch to the desired function.



 (Still Image)	Allows you to shoot still images (page 29, 30, 31, 33). You can set the desired still image shooting mode with MENU → [REC Mode].
 (Movie)	Allows you to record movies. Press the shutter button fully down to start recording, and then press the shutter button again to end the recording.

Using the internal memory

The camera has approximately 28 MB of internal memory. This memory is not removable. You can record images on the internal memory when there is no memory card inserted in the camera.

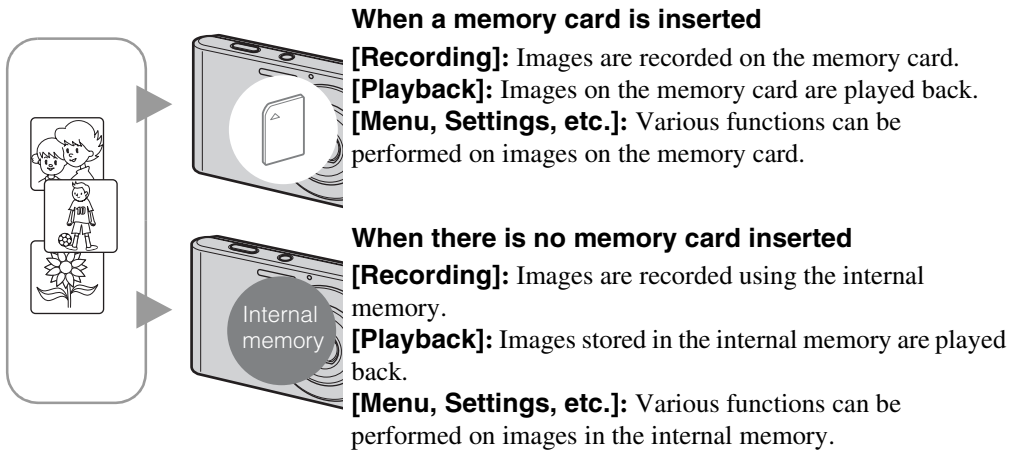

On image data stored in the internal memory

We recommend that you copy (back up) data without error using one of the following methods.

To copy (back up) data on a hard disk of your computer

Perform the procedure on page 82 without a memory card inserted in the camera.

To copy (back up) data on a memory card

Prepare a memory card with sufficient free capacity, then perform the procedure explained in [Copy] (page 74).

Notes

- You cannot transfer image data on a memory card to the internal memory.
- By making a USB connection between the camera and a computer with the dedicated USB cable, you can transfer data stored in the internal memory to a computer. However you cannot transfer data on a computer to the internal memory.

Zoom

You can enlarge the image when shooting. The camera's optical zoom function can enlarge images up to 4×.

1 Press the W/T (zoom) button.

Press the T button to zoom in, and the W button to zoom out.

- When the zoom scale exceeds 4×, see page 60.

T button



W button











Note

- You cannot change the zoom scale while shooting a movie.

DISP (Screen Display Settings)

- 1 Press DISP (Screen Display Settings) on the control button.
- 2 Select the desired mode with the control button.





	 (Bright + Image Only)	Sets screen brighter and displays only images.	
	 (Bright + Exposure Data) (Playback mode only)	Sets screen brighter and displays the information. Exif data for the recorded image is also displayed.	
	 (Bright)	Sets screen brighter and displays the information.	
✓	 (Normal)	Sets screen to standard brightness and displays the information.	

Note

- If you view images in bright outside light, adjust the screen brightness up. However, the battery power may decrease faster under such condition.

Flash

- 1 Press  (Flash) on the control button.
- 2 Select the desired mode with the control button.

✓	 AUTO (Auto)	Flash automatically operates in dark locations or when there is backlight.
	 (On)	Flash always operates.
	 SL (Slow Synchro)	Flash always operates. The shutter speed is slow in a dark place to clearly shoot the background that is out of flash light.
	 (Off)	Flash does not operate.

Notes

- The flash strobes twice. The first flash adjusts the light quantity.
- While charging the flash,  is displayed.
- You cannot use the flash during burst shooting.
- In Intelligent Auto Adjustment or Easy Mode, you can select only [Auto] or [Off].

When the “White circular spots” appears in flash photos

This is caused by particles (dust, pollen, etc.) floating close to the lens. When they are accentuated by the camera’s flash, they appear as white circular spots.

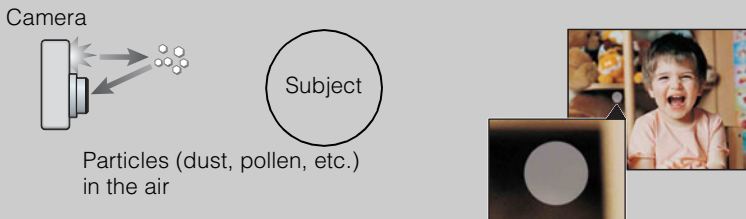

How can the “White circular spots” be reduced?

- Light the room and shoot the subject without a flash.
- Select  (High Sensitivity) mode in Scene Selection. ([Off] is automatically selected.)

Smile Shutter

When the camera detects a smile, the shutter is released automatically.

1 Press ☺ (Smile) on the control button.

2 Wait for a smile to be detected.

When the smile level exceeds the ◀ point on the indicator, the camera records images automatically.

If you press the shutter button during Smile Shutter, the camera shoots the image, then returns to Smile Shutter mode.

3 To stop shooting, press ☺ (Smile) again.

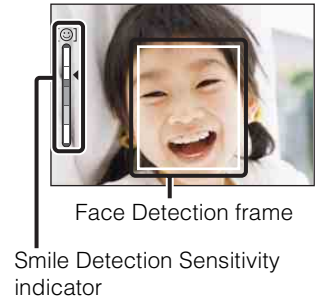

Notes

- Shooting using the Smile Shutter ends automatically when either the memory card or internal memory becomes full.
- Smiles may not be detected correctly depending on the conditions.
- You cannot use the digital zoom function.
- If Movie Mode is selected, you cannot use the Smile Shutter function.

💡 Hints for better capturing of smiles

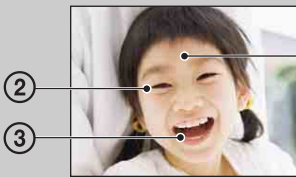





- ① Do not cover the eyes with the bangs.
Do not obscure the face by hat, masks, sunglasses, etc.
- ② Try to orient the face in front of the camera and be as level as possible. Keep the eyes narrowed.
- ③ Give a clear smile with an open mouth. The smile is easier to detect when the teeth are shown.

- The shutter operates when any person whose face is being detected smiles.
- You can select the priority subject for face detection with [Face Detection]. To perform smile detection for a different face, change the priority face with ● on the control button (page 48).
- If a smile is not detected, set the [Smile Detection Sensitivity] in setting menu.

Self-Timer

- 1 Press  (Self-Timer) on the control button.
- 2 Select the desired mode with the control button.

✓	 OFF (Off)	Does not use the self-timer.
	 10 (10sec)	Sets the 10-second delay self-timer. When you press the shutter button, the self-timer lamp flashes and a beep sounds until the shutter operates. To cancel, press  again.
	 2 (2sec)	Sets the 2-second delay self-timer.

Note

- In Easy Mode, you can select only [10sec] or [Off].

Reducing blurring with the two-second self-timer

Use the 2-second delay self-timer to prevent blur of an image. The shutter is released 2 seconds after you press the shutter button, which reduces camera shake when the shutter button is pressed.

Viewing still images

- 1 Press the  (Playback) button to switch to playback mode.
- 2 Select an image with the control button.

Playback zoom

Plays back the enlarged image.

- 1 Press **Q** (Playback zoom) button during still image playback.

The image is enlarged to twice the previous size, at the center of the image.

- 2 Adjust the position with the control button.
- 3 Change the zoom scale with **W/T** (zoom) button.

Press **Q** button (**T**) to zoom in, **W** side to zoom out.
Press **●** to cancel playback zoom.





Shows the displayed area of the whole image

To save enlarged images

You can save an enlarged image by using the trimming function.
Press **MENU** → [Retouch] → [Trimming].

Image Index

Displays multiple images at the same time.

- 1 Press the  (Playback) button to switch to playback mode.
- 2 Press the  (Index) button to display the image index screen.
Press the button again to display an index screen with more images.
- 3 To return to the single-image screen, select an image with the control button, then press .

Note

- When the camera is set to Easy Mode during image index display, the LCD screen changes to the single-image screen. You cannot view images in index mode during Easy Mode.



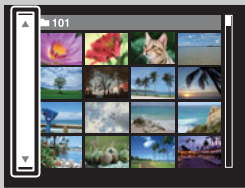

Displaying images of the desired folder



Select the left side bar with the control button, then select the desired folder with ▲/▼.

Delete

Allows you to select unwanted images for deletion. You can also delete images from the MENU button (page 54).

- 1 Press the  (Playback) button to switch to playback mode.
- 2  (Delete) button → desired mode → ● on the control button

All in This Folder	Deletes all images in the selected folder at once. Press [OK] → ● after step 2.
Multiple Images	Allows you to select and delete multiple images. Do as the following after step 2. ① Select an image then press ●. Repeat the above steps until there are no more images to be deleted. Select an image with a ✓ mark again to release the ✓ mark. ② MENU → [OK] → ●
This Image	Deletes the currently displayed image in single-image mode.
Exit	Cancels the deletion.

Note

- In Easy Mode, you can delete only the currently displayed image.

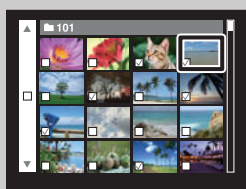

 You can switch between index and single-image mode when selecting images









Press the Q button (T) of the W/T (zoom) button in index mode to return to single-image mode, and press the  (Index) button (W) in single-image mode to return to index mode.

- You can also switch between index and single-image mode in [Protect], [DPOF] or [Print].

Viewing movies



- 1 Press the  (Playback) button to switch to playback mode.
- 2 Select a movie with the control button.
- 3 Press .
Movie playback starts.

Control button	Playback feature
	Play/Pause
	Fast forward
	Fast rewind
	Displays the volume control screen. <ul style="list-style-type: none">• Adjust the volume with / on the control button, then press .

Note



- You may not be able to play back some images shot using other cameras.

On the movie viewing screen

Select the image you want to display using / on the control button, and press .
The Playback bar appears, you can check a playback position of a movie.





Playback bar

 or  appears on the movie viewing screen.
The icon displayed may vary depending on image size.

REC Mode



1 Set the mode switch to  (Still Image).

2 MENU →  (REC Mode) → desired mode

✓	 (Intelligent Auto Adjustment)	Allows you to shoot with the setting adjusted automatically (page 29).
	P (Program Auto)	Allows you to shoot with the exposure adjusted automatically (both the shutter speed and the aperture value) (page 30). Also you can select various settings using the menu.
	SCN (Scene Selection)	Allows you to shoot with preset settings according to the scene (page 31).
	 (SteadyShot)	Allows you to shoot with reduced camera shake or subject blur (page 33).

Intelligent Auto Adjustment

Allows you to shoot still images with the setting adjusted automatically.

- 1 Set the mode switch to  (Still Image).
- 2 MENU →  (REC Mode) →  (Intelligent Auto Adjustment) → ● on the control button
- 3 Shoot with the shutter button.

Note







- Flash mode is set to [Auto] or [Off].

On Scene Recognition

Scene Recognition operates in Intelligent Auto Adjustment mode. This function lets the camera automatically recognize the shooting conditions and shoot the image.



Scene Recognition icon and guide

The camera recognizes  (Twilight),  (Twilight Portrait),  (Backlight),  (Backlight Portrait),  (Landscape),  (Macro) or  (Portrait), and displays the corresponding icon and guide on the LCD screen when the scene is recognized.

For details, see page 45.

If you shoot a still image of a subject that is difficult to focus on



- The shortest shooting distance is approximately 4 cm (1 5/8 inches) (W), 60 cm (23 5/8 inches) (T) (from the lens).
- When the camera cannot focus on the subject automatically, the AE/AF lock indicator changes to slowly flashing and the beep does not sound. Either recompose the shot or change the focus setting (page 42).

Focusing may be difficult in the following situations:

- It is dark and the subject is distant.
- The contrast between the subject and the background is poor.
- The subject is seen through glass.
- The subject is moving quickly.
- There is reflective light or shiny surfaces.
- The subject is backlit or there is a flashing light.



Program Auto

Allows you to shoot with the exposure adjusted automatically (both the shutter speed and the aperture value). Also you can select various settings using the menu.



- 1 Set the mode switch to  (Still Image).
- 2 MENU →  (REC Mode) → P (Program Auto) → ● on the control button
- 3 Shoot with the shutter button.

Scene Selection



Allows you to shoot with preset settings according to the scene.

- 1 Set the mode switch to  (Still Image).
- 2 MENU →  (REC Mode) → SCN (Scene Selection) → ● on the control button → desired mode

 (High Sensitivity)	Allows you to shoot images without a flash under low light conditions, reducing blur.		
 (Soft Snap)	Allows you to shoot images with a softer atmosphere for portraits and flowers, etc.		
 (Landscape)	Allows easy shooting of distant scenes by focusing in the distance. Shoots vivid blue sky and flora colors.		
 (Twilight Portrait)	Allows you to shoot sharp images of people with the night view in the background without compromising the atmosphere.		
 (Twilight)	Allows you to shoot night scenes at far distance without losing the dark atmosphere of the surroundings.		
 (Gourmet)	Shifts to Macro mode, allowing you to shoot food arrangements in delicious and bright color.		
 (Pet)	Allows you to shoot images of your pet with the best settings.		
 (Beach)	Allows you to record the blue of the water clearly when shooting seaside or lakeside scenes.		
 (Snow)	Allows you to record clear images preventing sunken colors in snowy scenes or other places where the whole screen appears white.		

 (Underwater)	Allows you to shoot underwater in natural colors in housing (Marine pack, etc.).	
--	--	---

























Note

- When you shoot images using  (Twilight Portrait) or  (Twilight) mode, the shutter speed is slower and the images tend to blur. To prevent blurring, the use of a tripod is recommended.

Functions you can use in Scene Selection

For shooting an image appropriately according to the scene condition, a combination of functions is determined by the camera. In the table below, ✓ indicates a user-changeable function, while — indicates an unchangeable one. The icons below [Flash] indicate the available flash modes.

Some functions are not available, depending on the Scene Selection mode.

	Flash	Face Detection/ Smile Shutter	Burst Settings	White Balance
 ISO		✓	—	✓* ¹
	✓	✓* ²	✓	—
	 	—	✓	—
	 SL	✓	—	—
		—	—	—
	 	—	—	✓
	 	—	—	✓
	 	✓	✓	—
	 	✓	✓	—
	 	—	✓	✓* ³



*¹ [Flash] for [White Balance] cannot be selected.

*² [Off] for [Face Detection] cannot be selected.



*³ You can use [Underwater White Balance] instead of [White Balance].

SteadyShot

Allows you to shoot with reduced camera shake or subject blur.

- 1 Set the mode switch to  (Still Image).
- 2 MENU →  (REC Mode) →  (SteadyShot) → ● on the control button
- 3 Shoot with the shutter button.

Hints for preventing blur

If the camera moves accidentally when you shoot an image, “camera shake” occurs. On the other hand, if the subject moves when you shoot an image, “subject blur” can occur. Camera shake and subject blur occur frequently under low-light or slow shutter speed conditions, such as those encountered in  (Twilight Portrait) or  (Twilight) mode. In such a case, shoot with the below tips in mind.

Camera shake

Your hands or body moves while holding the camera and pressing the shutter button, and the entire screen is blurred.

- Use a tripod or place the camera on a flat surface to hold the camera steady.
- Shoot with a 2-second delay self-timer and stabilize the camera by holding your arms firmly at your side after pressing the shutter button.

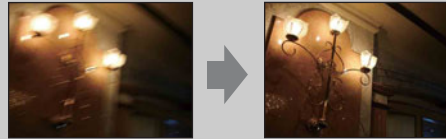

Subject blur

Even though the camera is steady, the subject moves during the exposure and is captured blurred when the shutter button is pressed.

- Select  (High Sensitivity) mode in Scene Selection.
- Select a higher ISO sensitivity to make the shutter speed faster, and press the shutter button before the subject moves.

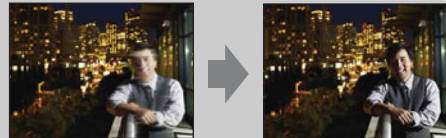

Easy Mode



Allows you to shoot still images using the minimum necessary functions.
The text size increases and indicators become easier to see.

- 1 MENU → **EASY** (Easy Mode) → [OK] → ● on the control button.
- 2 Shoot with the shutter button.

Notes

- The battery power may decrease faster because the screen brightness increases automatically.
- When the  (Playback) button is pressed, the playback mode also changes to [Easy Mode].

Shooting functions available in Easy Mode







Image Size:	MENU → [Image Size] → ● on the control button → desired mode → ● Select between [Large] or [Small] size.
Self-Timer:	 on the control button → desired mode Select between [10sec] or [Off] mode.
Flash:	 on the control button → desired mode Select between [Auto] or [Off] mode.
Smile Shutter:	 on the control button
Exit Easy Mode:	MENU → [Exit Easy Mode] → [OK] → ● on the control button

On Scene Recognition

Scene Recognition operates in Easy Mode. This function lets the camera automatically recognize the shooting conditions and shoot the image.



Scene Recognition icon

The camera recognizes , , , , ,  (Macro) or  (Portrait), and displays the corresponding icon on the LCD screen when the scene is recognized.











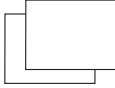

For details, see page 45.

Image Size

The image size determines the size of the image file that is recorded when you take a image. The larger the image size, the more detail will be reproduced when the image is printed on large-format paper. The smaller the image size, the more images can be recorded.

1 MENU →  (Image Size) → desired size

When shooting still images

	Image size	Usage guidelines	No. of images	Printing
✓	 (4320×3240) 14M	For prints up to A3+ size	Less 	Fine 
	 (3648×2736) 10M		↑	↑
	 (2592×1944) 5M	For prints from 10×15 cm up to A4 size	↓	↓
	 (640×480) VGA	For e-mail attachments	More 	Rough 
	 (4320×2432) 11M	For viewing on a high-definition TV, and for prints up to A3 size	Less 	Fine 
	 (1920×1080) 2M	For viewing on a high-definition TV	More 	Rough 

Note

- When you print still images recorded with 16:9 aspect ratio, both edges may be cut off.

In Easy Mode

✓	Large	Shoots images in [14M] size.
	Small	Shoots images in [5M] size.

When shooting movies

The larger the image size, the higher the image quality.

The movies shot with this camera will be recorded in AVI (Motion JPEG), Approx. 30fps format.

	Movie image size	Usage guidelines
✓	VGA: VGA (640×480)	For viewing on a TV screen
	QVGA: QVGA (320×240)	For sending as an e-mail attachment

💡 On “image quality” and “image size”

A digital image is made up of a collection of small dots called pixels.

If it contains a large number of pixels, the image becomes large, it takes up more memory, and the image is displayed in fine detail. “Image size” is shown by the number of pixels.

Although you cannot see the differences on the screen of the camera, the fine detail and data processing time differ when the image is printed or displayed on a computer screen.

Description of the pixels and the image size

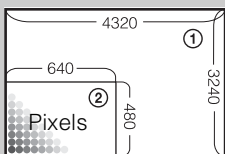

- ① Image size: 14M
4320 pixels × 3240 pixels = 13,996,800 pixels
- ② Image size: VGA
640 pixels × 480 pixels = 307,200 pixels

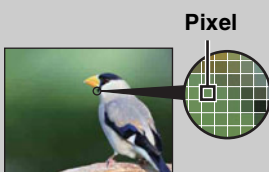

Many pixels
(Fine image quality and large file size)





Few pixels
(Rough image quality but small file size)

Burst Settings

You can select single shooting or burst mode.

1 MENU →  (Burst Settings) → desired mode

✓	 (Single)	Shoots a single image.
	 (Burst)	<p>Shoots up to 100 images in succession when you press and hold down the shutter button.</p>  <p>Notes</p> <ul style="list-style-type: none">• Burst shooting is not available in Easy Mode, Movie Mode or Smile Shutter.• The flash is set to [Off].• When recording with the self timer, a series of a maximum of five images is recorded.• The recording interval becomes longer, depending on the setting for the image size.• When the battery level is low, or when the internal memory or memory card is full, the Burst stops.• [Focus], [White Balance] and [EV] are adjusted for the first image, and these settings are also used for the other images.

EV

You can adjust the exposure manually in 1/3 EV steps in a range of -2.0 EV to +2.0 EV.

1 MENU → 0EV (EV) → desired EV setting

Notes

- In Easy Mode, the EV setting cannot be adjusted.
- If you shoot a subject in extremely bright or dark conditions, or when you use the flash, the exposure adjustment may not be effective.

💡 Adjusting the exposure for better looking images



Overexposure = too much light
Whitish image



Lower EV setting -



Correct exposure



Higher EV setting +

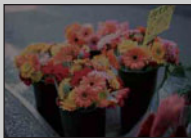

Underexposure = too little light
Darker image

ISO

Adjusts the luminous sensitivity when the camera is set to Program Auto or 🐟 (Underwater) in Scene Selection.

1 MENU → ^{ISO}_{AUTO} (ISO) → desired mode

✓	ISO AUTO (Auto)	Sets the ISO sensitivity automatically.
	ISO / ISO / ISO / ISO / 80 / 100 / 200 / 400 / ISO / ISO / ISO 800 / 1600 / 3200	You can reduce image blurring in dark locations or moving subjects by increasing ISO sensitivity (select a larger number).

Note

- ISO settings other than [ISO AUTO], [ISO 80] to [ISO 800] cannot be selected when the recording mode is set to Burst mode, or when [DRO] is set to [DRO plus].

💡 Adjusting ISO Sensitivity (Recommended Exposure Index)

ISO sensitivity is a speed rating for recording media that incorporates an image sensor that receives light. Even when the exposure is the same, images differ depending on the ISO sensitivity.



High ISO sensitivity

Records a bright image even in dark locations while increasing shutter speed to reduce blur. However, the image tends to become noisy.



Low ISO sensitivity

Records a smoother image. However, when the exposure is insufficient, the image may become darker.

White Balance

Adjusts color tones according to the surrounding light conditions. Use this function if image color appears unnatural.

1 MENU → $\frac{WB}{AUTO}$ (White Balance) → desired mode

✓	$\frac{WB}{AUTO}$ (Auto)	Adjusts the white balance automatically so that the colors appear natural.
	☀ (Daylight)	Adjusts for outdoors conditions on a fine day, evening views, night scenes, neon signs, fireworks, etc.
	☁ (Cloudy)	Adjusts for a cloudy sky or a shady location.
	☼ ₁ (Fluorescent White Balance 1) ☼ ₂ (Fluorescent White Balance 2) ☼ ₃ (Fluorescent White Balance 3)	[Fluorescent White Balance 1]: Adjusts for white fluorescent lighting. [Fluorescent White Balance 2]: Adjusts for natural white fluorescent lighting. [Fluorescent White Balance 3]: Adjusts for day white fluorescent lighting.
	💡 (Incandescent)	Adjusts for places under incandescent lamp, or under bright lighting, such as in a photo studio.
	⚡ _{WB} (Flash)	Adjusts for the flash conditions.





Notes

- [White Balance] cannot be adjusted in Intelligent Auto Adjustment, or Easy Mode.
- You cannot adjust [Flash] in [White Balance] in Movie Mode, or when Scene Selection is set to \triangle iso (High Sensitivity) mode.
- Under fluorescent lights that flicker, the white balance function may not work correctly even though you select [Fluorescent White Balance 1], [Fluorescent White Balance 2], or [Fluorescent White Balance 3].
- When shooting with a flash in other than [Flash] mode, [White Balance] is set to [Auto].
- When flash is [On] or [Slow Synchro], the white balance can only be adjusted to [Auto] or [Flash].

💡 Effects of lighting conditions

The apparent color of the subject is affected by the lighting conditions.





The color tones are adjusted automatically, but you can adjust color tones manually using the White Balance function.

Weather/lighting	Daylight	Cloudy	Fluorescent	Incandescent
Characteristics of light	White (standard) 	Bluish 	Green-tinged 	Reddish 

Underwater White Balance

Adjusts the color tone when the camera is set to  (Underwater) mode in Scene Selection.

1 MENU →  (Underwater White Balance) → desired mode

	 (Auto)	Automatically adjusts color tones underwater so they appear natural.
	 (Underwater 1)	Adjusts for underwater conditions where blue is strong.
	 (Underwater 2)	Adjusts for underwater conditions where green is strong.



Notes







- Depending on the color of the water, the Underwater White Balance may not work correctly even though you select [Underwater 1] or [Underwater 2].
- When flash is [On], the underwater white balance can only be adjusted to [Auto].

Focus

You can change the focus method. Use the menu when it is difficult to get the proper focus in auto focus mode.

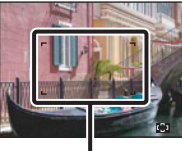
AF stands for “Auto Focus,” a function that adjusts the focus automatically.

1 MENU →  (REC Mode) → P (Program Auto) →  (Focus) → desired mode

✓	 (Multi AF)	<p>Focuses on a subject in all ranges of the finder frame automatically.</p> <p>When you press the shutter button halfway in still image shooting mode, a green frame is displayed around the area that is in focus.</p> <ul style="list-style-type: none"> • When the Face Detection function is active, AF operates with priority on faces. • When Scene Selection is set to  (Underwater) mode, focus operation is suited to underwater shooting. When focus is achieved by half-pressing the shutter button, a large frame is displayed in green. 	 <p>AF range finder frame</p>
	 (Center AF)	<p>Focuses on a subject in the center of the finder frame automatically. Using the AF lock function together, you can compose the image the way you want.</p>	 <p>AF range finder frame</p>
	 (Spot AF)	<p>Focuses on an extremely small subject or a narrow area automatically. Using the AF lock function together, you can compose the image the way you want. Hold the camera steady so as not to misalign the subject and the AF range finder frame.</p>	 <p>AF range finder frame</p>

Notes

- When you use [Digital Zoom], the AF range finder frame is disabled and appears in a dotted line. In this case, the camera works to focus on the subjects at the center of the screen.
- When the focus mode is set to other than [Multi AF], you cannot use the Face Detection function.
- The focus mode is fixed to [Multi AF] in the following situations:
 - In Intelligent Auto Adjustment
 - In Easy Mode
 - In Movie Mode
 - When the Smile Shutter function is activated

Focusing on subjects near the edge of the screen

If the subject is out of focus, do as follows:

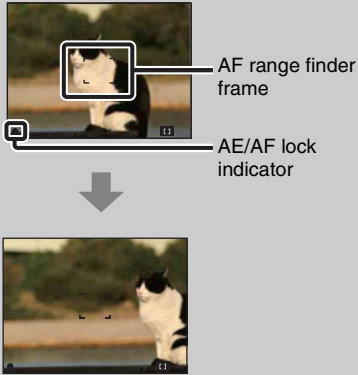



- ① Recompose the shot so that the subject is centered in the AF range finder, and press the shutter button halfway to focus on the subject (AF lock).
 - ② When the AE/AF lock indicator stops flashing and remains on, return to the fully composed shot, and press the shutter button fully down.
- As long as you do not press the shutter button fully down, you can retry the procedure as many times as necessary.



Metering Mode





Selects the metering mode that sets which part of the subject to measure to determine the exposure.

When shooting still images:

- 1 MENU →  (REC Mode) → P (Program Auto) →  (Metering Mode) → desired mode

When shooting movies:

- 1 Set the mode switch to  (Movie) → MENU →  (Metering Mode) → desired mode.

✓	 (Multi)	Divides into multiple regions and measures each region. The camera determines a well-balanced exposure (Multi-pattern metering).	
	 (Center)	Measures the center of the image, and determines the exposure based on the brightness of the subject there (Center-weighted metering).	
	 (Spot)	Measures only a part of the subject (Spot metering). This function is useful when the subject is backlit or when there is strong contrast between the subject and the background.	 <p>Spot metering cross hairs Positions on the subject</p>

Notes

- In Movie Mode, [Spot] cannot be selected.
- If you set Metering Mode to other than [Multi], the Face Detection function cannot be used.
- Metering Mode is fixed to [Multi] in the following situations:
 - In Intelligent Auto Adjustment
 - In Easy Mode
 - When the Smile Shutter function is activated

Scene Recognition







The camera automatically detects shooting conditions, and then takes the shot. When motion is detected, the ISO sensitivity is increased according to the movement to reduce subject blur (Motion Detection).

Example of an image where  (Backlight) has activated.







Scene Recognition icon and guide

The camera recognizes the following types of scenes. When the camera determines the optimal scene, it displays the corresponding icon and guide.

-  (Twilight),  (Twilight Portrait),  (Backlight),
-  (Backlight Portrait),  (Landscape),  (Macro),
-  (Portrait)

1 MENU →  (REC Mode) →  (Intelligent Auto Adjustment) →  (Scene Recognition) → desired mode

✓	iSCN (Auto)	When the camera recognizes the scene, it switches to the optimal settings and shoots the image.
	iSCN⁺ (Advanced)	<p>When the camera recognizes the scene, it switches to the optimal settings. If the camera recognizes  (Twilight),  (Twilight Portrait),  (Backlight) or  (Backlight Portrait), it automatically changes the setting and shoots another image.</p> <ul style="list-style-type: none"> • When you shoot two images consecutively, the + mark on the  icon will turn green. • When two frames are shot, the two images are displayed side by side immediately after shooting.

Notes

- Scene Recognition does not function when using digital zoom.
- When Burst mode is selected, or when the Smile Shutter function is activated, Scene Recognition is fixed to [Auto].
- The available flash settings are [Auto] and [Off].
- These scenes may not be recognized depending on the situation.



Shooting twice, choosing the best image later ([Advanced])

In [Advanced], when the camera recognizes a difficult-to-shoot scene (☾ (Twilight), 👤 (Twilight Portrait), 📷 (Backlight) and 👤📷 (Backlight Portrait)), it changes the settings as follows and shoots two images with different effects, allowing you to select the one you like.

	First Image*	Second Image
☾	Shoot in Slow Synchro	Shoots with sensitivity increased and shake reduced
👤	Shoot in Slow Synchro with the face which the flash strobes on as guide	Shoots with sensitivity increased with the face as guide and shake reduced
📷	Shoots with the flash	Shoots with the brightness and contrast of the background adjusted (DRO plus)
👤📷	Shoots with the face which the flash strobes on as guide	Shoots with the brightness and contrast of the face and the background adjusted (DRO plus)

* When flash is set to [Auto].

Smile Detection Sensitivity

Sets the sensitivity of the Smile Shutter function for detecting smiles.

1 MENU → 😊 (Smile Detection Sensitivity) → desired mode

	😊 (Big Smile)	Detects a big smile.
✓	😊 (Normal Smile)	Detects a normal smile.
	😊 (Slight Smile)	Detects even a slight smile.

Notes

- Smiles may not be detected correctly depending on the conditions.
- [Smile Detection Sensitivity] cannot be adjusted in Easy Mode or Movie Mode.

Face Detection

When the Face Detection function is used, the camera detects the faces of your subjects and adjusts the focus, flash, exposure, white balance and red-eye reduction settings automatically.





Face Detection frame (Orange)

When the camera detects more than one subject, the camera will judge which is the main subject and set focus by priority. The Face Detection frame for the main subject will turn orange. The frame for which the focus is set will turn green by pressing the shutter button halfway down.

Face Detection frame (White)

1 MENU →  (Face Detection) → desired mode

 (Off)	Does not use Face Detection function.
 (Auto)	Selects the face the camera is to automatically focus on.

Notes

- [Face Detection] cannot be selected in Easy Mode or Movie Mode.
- You can select [Face Detection] only when the focus mode is set to [Multi AF] and the metering mode is set to [Multi].
- The Face Detection function does not work when using the digital zoom.
- Up to 8 faces of your subjects can be detected.
- During Smile Shutter shooting, [Face Detection] is automatically set to [Auto] even if it is set to [Off].

Selecting the priority face

Normally the camera automatically selects the face to focus on according to the [Face Detection] setting, but you can also select a face to be given priority.





Face Priority Frame Off



- ① Press ● on the control button during Face Detection. The leftmost face is selected as the priority face, and the frame changes from □ to an orange frame (□).
 - ② Each time you press ●, the priority face moves one face to the right. Press ● repeatedly until the orange frame (□) is on the face you want to select.
 - ③ To cancel the face selection (Off), move the orange frame to the rightmost face, then press ● again.
- It may not be possible to detect the selected face correctly depending on the surrounding brightness, the subject's hairstyle, etc. In this case, select the face again under the conditions where the image will be shot.
 - When the Smile Shutter function is used with the Face Detection frame selected, Smile Detection is performed only on the selected face.
 - You cannot select the priority face in Easy Mode.

DRO

The camera analyzes the shooting scene and automatically corrects the brightness and contrast to improve the image quality.

DRO stands for “Dynamic Range Optimizer,” a function that automatically optimizes the difference between light and dark parts of an image.

1 MENU →  (REC Mode) → P (Program Auto) →  (DRO) → desired mode

	 (Off)	Does not adjust.
✓	 (DRO standard)	Adjusts the brightness and contrast of the images automatically.
	 (DRO plus)	Adjusts image brightness and contrast automatically and strongly.

Notes

- Depending on shooting conditions, it may not be possible to obtain correction effects.
- Only [ISO AUTO] or values from [ISO 80] to [ISO 800] can be set for the ISO value when [DRO plus] is set.

Easy Mode

When viewing still images in Easy Mode, the playback screen text becomes larger, and indicators become easier to see.

- 1 Press the  (Playback) button to switch to playback mode.
- 2 MENU → **EASY** (Easy Mode) → [OK] → ● on the control button

Notes

- The battery charge is used up more quickly because the screen brightness increases automatically.
- The shooting mode also changes to [Easy Mode].





Viewing functions available in Easy Mode

In Easy Mode, only the deletion function is available.

- | | |
|--|---|
|  (Delete) button | You can delete the currently displayed image. Select [OK] → ●. |
| MENU button | You can delete the currently displayed image with [1 image], and delete all images in a folder with [All].
Select [Exit Easy Mode] → [OK] to exit Easy Mode. |

Slideshow

Images are automatically played back in succession.

- 1 Press the  (Playback) button to switch to playback mode.
- 2 MENU →  (Slideshow) → ● on the control button
- 3 Select a desired setting.
- 4 [Start] → ●
- 5 Press ● to end the slideshow.

Note

- You cannot play back movies.

Image

Selects the group of images to be shown.

<input checked="" type="checkbox"/>	All	Plays a slideshow of all the still images in order.
<input type="checkbox"/>	Folder	Plays a slideshow of still images in the currently selected folder.

Note

- This setting is fixed to [Folder] when the internal memory is used to record images.

Interval

Sets the screen switching interval.

<input type="checkbox"/>	1 sec	Switches the screen at the selected interval.
<input checked="" type="checkbox"/>	3 sec	
<input type="checkbox"/>	5 sec	
<input type="checkbox"/>	10 sec	



Repeat



Turns slideshow repeat on or off.

<input checked="" type="checkbox"/>	On	Plays back images in a continuous loop.
<input type="checkbox"/>	Off	After all the images have been played back, the slideshow ends.

Retouch

Retouches a recorded image and saves it as a new file.
The original image is retained.

- 1 Press the  (Playback) button to switch to playback mode.
- 2 MENU →  (Retouch) → desired mode → ● on the control button
- 3 Perform retouching according to the operation method in each mode.



 (Trimming)	<p>Records the zoomed playback image.</p> <ol style="list-style-type: none"> ① Press the Q button (T) to zoom in and press W to zoom out. ② Set the zoom point with the control button. ③ MENU → select an image size to save → ● ④ [OK] → ● <ul style="list-style-type: none"> • The quality of trimmed images may deteriorate. • The image size that you can trim may vary depending on the image.
 (Red Eye Correction)	<p>Corrects the red-eye phenomenon caused by flash.</p> <ol style="list-style-type: none"> ① Select [OK] with the control button → ●. <ul style="list-style-type: none"> • You may not be able to correct the red-eye phenomenon depending on the image.



Note

- You cannot retouch the movies.

Delete

Allows you to select unwanted images for deletion. You can also delete images using the  (Delete) button (page 26).

- 1 Press the  (Playback) button to switch to playback mode.
- 2 MENU →  (Delete) → desired mode → ● on the control button
- 3 [OK] → ●

 (This Image)	Deletes the currently displayed image in single-image mode.
 (Multiple Images)	You can select and delete multiple images. Do as the following after step 2. ① Select an image then press ●. Repeat the above steps until there are no more images to be deleted. Select an image with a ✓ mark to release the ✓ mark. ② MENU → [OK] → ●
 (All in This Folder)	Deletes all images in the selected folder at once.



Note



- In Easy Mode, you can select between [1 image] or [All].

Protect

Protects recorded images against accidental erasure.

The  mark is displayed for registered images.

- 1 Press the  (Playback) button to switch to playback mode.
- 2 MENU →  (Protect) → desired mode → ● on the control button

 (This Image)	Protects the currently displayed image in single-image mode.
 (Multiple Images)	You can select and protect multiple images. Do as the following after step 2. ① Select an image then press ●. Repeat the above steps until there are no more images to be protected. Select an image with a ✓ mark to release the ✓ mark. ② MENU → [OK] → ●



To cancel the protection

Select the image for which you want to cancel protection, and unlock it by pressing ● on the control button as the same procedure to protect it.



The  indicator disappears, and the protection is released.

DPOF

DPOF (Digital Print Order Format) is a function that allows you to specify the images of the memory card that you want to print out later.

The **DPOF** (Print order) mark is displayed for registered images.

- 1 Press the  (Playback) button to switch to playback mode.
- 2 MENU → **DPOF** → desired mode → ● on the control button

DPOF  (This Image)	Orders printing the currently displayed image in single-image mode.
DPOF  (Multiple Images)	You can select and order printing multiple images. Do as the following after step 2. ① Select an image then press ●. Repeat the above steps until there are no more images to be printed. Select an image with a ✓ mark to release the ✓ mark. ② MENU → [OK] → ●

Notes

- The **DPOF** (Print order) mark cannot be added to movies or to images in the internal memory.
- You can add a **DPOF** (Print order) mark to a maximum 999 images.

Clearing the DPOF mark







Select the image to clear the DPOF registration, then press ● on the control button in the same procedure as when making a **DPOF** mark.

The **DPOF** mark disappears and the DPOF registration is cleared.

Rotate

Rotates a still image. Use this to display a horizontal orientation image in vertical orientation.





- 1 Press the  (Playback) button to switch to playback mode.
- 2 MENU →  (Rotate) → ● on the control button
- 3 Rotate the image with [/] → /.
- 4 [OK] → ●

Notes

- You cannot rotate movies or protected still images.
- You may not be able to rotate images shot with other cameras.
- When viewing images on a computer, the image rotation information may not be reflected depending on the software.

Select Folder

When multiple folders are created in a memory card, this selects the folder containing the image you want to play back.

- 1 Press the  (Playback) button to switch to playback mode.
- 2 MENU →  (Select Folder) → ● on the control button
- 3 Select the folder with ◀▶.
- 4 [OK] → ●



Note

- This item is not displayed when the internal memory is used to record images.





Viewing images across multiple folders

When multiple folders are created, the following indicators appear on the first and last images in the folder.

- : Moves to the previous folder
- : Moves to the next folder
- : Moves to either the previous or next folders

Grid Line



With reference to the grid lines, you can easily set a subject in a horizontal/vertical position.

- 1 Set the camera to shooting mode.
- 2 MENU →  (Settings) →  (Shooting Settings) → [Grid Line] → desired mode → ● on the control button

	On	Displays the grid lines. The grid lines are not recorded.
✓	Off	Does not display the grid lines.

Digital Zoom

Selects the digital zoom mode. The camera enlarges the image using optical zoom (up to 4×). When the zoom scale is exceeded, the camera uses either smart or precision digital zoom.

- 1 Set the camera to shooting mode.
- 2 MENU →  (Settings) →  (Shooting Settings) → [Digital Zoom] → desired mode → ● on the control button

✓	Smart (SQ)	Enlarges the image digitally within the range where the image will not be distorted, according to the image size (Smart zoom).
	Precision (PQ)	Enlarges all image sizes by the total zoom scale of approximately 8×, including the optical zoom 4×. However, note that the image quality deteriorates when the optical zoom scale is exceeded (Precision digital zoom).
	Off	Does not use the digital zoom.

Notes

- The Digital Zoom function does not operate in Movie Mode or when the Smile Shutter function is activated.
- The smart zoom is not available when the image size is set to [14M] or [16:9(11M)].
- The Face Detection function does not work when using the digital zoom.



Total zoom scale when using Smart zoom (including optical zoom 4×)

The supported zoom ratio differs depending on the image size.

Size	Total zoom scale
10M	Approx. 4.7×
5M	Approx. 6.7×
VGA	Approx. 27×
16:9(2M)	Approx. 9.0×

Red Eye Reduction

The flash strobesc two or more times before shooting to reduce the red-eye phenomenon when using the flash.

- 1 Set the camera to shooting mode.
- 2 MENU →  (Settings) →  (Shooting Settings) → [Red Eye Reduction] → desired mode → ● on the control button

✓	Auto	When the Face Detection function is activated, the flash strobesc automatically to reduce the red-eye phenomenon.
	On	The flash always strobesc to reduce the red-eye phenomenon.
	Off	Does not use Red Eye Reduction.

Notes

- To avoid blurring of images, hold the camera firmly until the shutter is released. It usually takes a second until the shutter is released, and also be sure not to allow the subject to move during this period.
- Red Eye Reduction may not produce the desired effects. It depends on individual differences and conditions, such as distance to the subject, or if the subject looked away from the pre-strobe.
- If you do not use the Face Detection function, Red Eye Reduction does not work, even when you select [Auto].

What causes the red-eye phenomenon?

Pupils become dilated in dark environments. Flash light is reflected off the blood vessels at the back of the eye (retina), causing the “red-eye” phenomenon.





Other ways to reduce red-eye

- Select  (High Sensitivity) mode in Scene Selection. (The flash is set to [Off] automatically.)
- When the eyes of the subject turn out red, correct the image with [Retouch] → [Red Eye Correction] on the viewing menu or with the supplied software “PMB”.

Beep



Selects or turns off the sound produced when you operate the camera.

- 1 MENU →  (Settings) →  (Main Settings) → [Beep] → desired mode → ● on the control button

	Shutter	Turns on the shutter sound when you press the shutter button.
✓	High	Turns on the beep/shutter sound when you press the control/shutter button.
	Low	If you want to lower the volume, select [Low].
	Off	Turns off the beep/shutter sound.



Language Setting

Selects the language to be used in the menu items, warnings and messages.

- 1 MENU →  (Settings) →  (Main Settings) → [Language Setting] → desired mode → ● on the control button

Function Guide

You can select whether or not the function guide is displayed when you operate the camera.



1 MENU →  (Settings) →  (Main Settings) → [Function Guide] → desired mode → ● on the control button

✓	On	Displays the function guide.
	Off	Does not display the function guide.

Power Save

Sets the time until the camera turns off.

If you do not operate the camera running on a battery pack for a certain amount of time, the camera automatically turns off to prevent wearing down the battery pack (Auto Power off).



1 MENU →  (Settings) →  (Main Settings) → [Power Save] → desired mode → ● on the control button

	Stamina	The camera turns off after about 1 minute of no operation.
✓	Standard	The camera turns off after about 2 minutes of no operation.
	Off	The camera does not turn off automatically.

Initialize

Initializes the setting to the default setting.

Even if you execute this function, the images are retained.

1 MENU →  (Settings) →  (Main Settings) → [Initialize] → [OK] → ● on the control button



Note

- Be sure not to turn off the camera while initializing.

Video Out

Sets the video signal output according to the TV color system of the connected video equipment. The TV color systems differ depending on the country and region.



To view images on a TV screen, check the TV color system of the country or region of use (page 78).

1 MENU →  (Settings) →  (Main Settings) → [Video Out] → desired mode → ● on the control button

NTSC	Sets the video output signal to NTSC mode (e.g., for the USA, Japan).
PAL	Sets the video output signal to PAL mode (e.g., for Europe, China).

USB Connect

Selects the USB mode when connecting the camera to a computer or a PictBridge-compliant printer using the dedicated USB cable.

1 MENU →  (Settings) →  (Main Settings) → [USB Connect] → desired mode → ● on the control button



✓	Auto	The camera recognizes automatically and sets up communication with a computer or PictBridge-compliant printer.
	PictBridge	Connects the camera to a PictBridge-compliant printer.
	PTP/MTP	When you connect the camera to a computer, the AutoPlay Wizard appears, and the still images in the recording folder on the camera are imported to the computer. (with Windows 7/Vista/XP, Mac OS X)
	Mass Storage	Establishes a Mass Storage connection between the camera and a computer or other USB device.

Notes

- If you cannot connect the camera to a PictBridge-compliant printer with the [Auto] setting, select [PictBridge].
- If you cannot connect the camera to a computer or a USB device with the [Auto] setting, select [Mass Storage].
- When [USB Connect] is set to [PTP/MTP], you cannot export movies to a computer. To export movies to a computer, set [USB Connect] to [Auto] or [Mass Storage].

LUN Settings

Sets the display method for the recording media displayed on a computer screen or other monitor when the camera is connected with a computer or AV component using a USB connection.

1 MENU →  (Settings) →  (Main Settings) → [LUN Settings] → desired mode → ● on the control button



✓	Multi	The images both on the memory card and in the internal memory are displayed. Select this setting when you connect the camera to a computer.
	Single	When the memory card is inserted into the camera, the images on the memory card are displayed; when it is not inserted, the images in the internal memory are displayed. Select this setting in cases where the images of both the memory card and the internal memory are not displayed when the camera is connected to a device other than a computer.

Note

- Set [LUN Settings] to [Multi] when uploading images to a media service using “PMB Portable”.

Format

Formats the memory card or the internal memory. When you use a memory card with this camera for the first time, it is recommended to format the card using the camera for stable performance of the memory card before shooting. Note that formatting permanently erases all data on the memory card, and is unrecoverable. Save precious data on a computer, etc.

1 MENU →  (Settings) →  (Memory Card Tool) or  (Internal Memory Tool) → [Format] → [OK] → ● on the control button



Note

- Note that formatting permanently erases all data including even protected images.

Create REC.Folder

Creates a folder in a memory card for recording images.

Images are recorded in the newly created folder until you create another folder or select another recording folder.

1 MENU →  (Settings) →  (Memory Card Tool) → [Create REC.Folder] → [OK] → ● on the control button

Notes

- This item is not displayed when the internal memory is used to record images.
- When you insert a memory card that was used with other equipment into the camera and shoot images, a new folder may be automatically created.
- Up to 4,000 images can be stored in one folder. When the folder capacity is exceeded, a new folder is automatically created.





On the folders

After a new folder is created, you can change the storage destination folder (page 72) and select the folder for viewing images (page 58).

Change REC.Folder

Changes the folder in the memory card that is currently used for recording images.



- 1 MENU →  (Settings) →  (Memory Card Tool) → [Change REC.Folder]
- 2 Select a folder with ◀/▶ on the control button.
- 3 [OK] → ●

Notes

- This item is not displayed when the internal memory is used to record images.
- You cannot select the “100” folder as a recording folder.
- You cannot move recorded images to another folder.

Delete REC.Folder

Deletes a folder for recording images in a memory card.



- 1 MENU →  (Settings) →  (Memory Card Tool) → [Delete REC.Folder]
- 2 Select a folder with ◀/▶ on the control button.
- 3 [OK] → ●

Notes

- This item is not displayed when the internal memory is used to record images.
- If you delete the folder set as the recording folder using [Delete REC.Folder], the folder that has the largest folder number is selected as the next recording folder.
- You can delete only empty folders. If a folder contains images, or files that cannot be played back by the camera, first delete these images and files, and then delete the folder.

Copy

Copies all images in the internal memory to a memory card.



- 1 Insert a memory card with sufficient free capacity into the camera.
- 2 MENU →  (Settings) →  (Memory Card Tool) → [Copy] → [OK] → ● on the control button

Notes

- Use a fully charged battery pack. If you attempt to copy image files using a battery pack with little remaining charge, the battery pack may run out, causing copying to fail or possibly corrupting the data.
- Images cannot be copied individually.
- The original images in the internal memory are retained even after copying. To delete the contents of the internal memory, remove the memory card after copying, then format the internal memory ([Format] in [Internal Memory Tool]).
- A new folder is created on the memory card and all the data will be copied to it. You cannot choose a specific folder and copy images to it.

File Number



Selects the method used to assign file numbers to images.

- 1 MENU →  (Settings) →  (Memory Card Tool) or  (Internal Memory Tool) → [File Number] → desired mode → ● on the control button

✓	Series	Assigns numbers to files in sequence even if the recording folder or the memory card is changed. (When the replaced memory card contains a file with a number higher than the last assigned number, a number one higher than the largest number is assigned.)
	Reset	Starts from 0001 each time the folder is changed. (When the recording folder contains a file, a number one higher than the largest number is assigned.)

Date & Time Setting

Sets the date and time again.

- 1 MENU →  (Settings) →  (Clock Settings) → [Date & Time Setting] → desired setting → ● on the control button
- 2 Set the numeric value and desired setting with ▲/▼/◀/▶ on the control button.
- 3 [OK] → ●

Date & Time Format	You can select the date and time display format.
Date & Time	You can set the date and time.

Note

- The camera does not have a feature for superimposing dates on images. By using “PMB” in the CD-ROM (supplied), you can print or save images with the date.

Viewing images on a TV

You can view images on a TV by connecting the camera to a TV.
The connection varies according to the type of TV the camera is connected to.
Refer also to the operating instructions supplied with the TV.

Viewing images by connecting the camera to a TV with the dedicated A/V cable (supplied)

- 1 Turn off both the camera and the TV.
- 2 Connect the camera to the TV with the dedicated A/V cable (supplied).

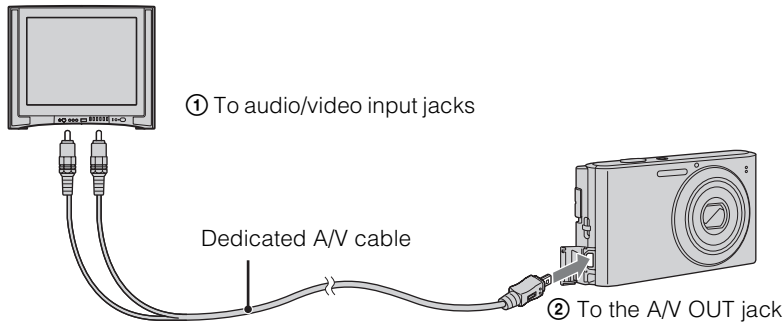

- 3 Turn on the TV and set the input.
- 4 Press  (Playback) button to turn on the camera.

Images shot with the camera appear on the TV. Select the desired image with the control button.

Notes

- When using the camera abroad, it may be necessary to switch the video signal output to match that of your TV system (page 67).
- When output to TV, Easy Mode is invalid.

On TV color systems

If you want to view images on a TV screen, you need a TV with a video input jack and the dedicated A/V cable. The color system of the TV must match that of the digital still camera. Check the following lists for the TV color system of the country or region where the camera is used.

NTSC system

Bahama Islands, Bolivia, Canada, Central America, Chile, Colombia, Ecuador, Jamaica, Japan, Korea, Mexico, Peru, Surinam, Taiwan, the Philippines, the U.S.A., Venezuela, etc.

PAL system

Australia, Austria, Belgium, China, Croatia, Czech Republic, Denmark, Finland, Germany, Holland, Hong Kong, Hungary, Indonesia, Italy, Kuwait, Malaysia, New Zealand, Norway, Poland, Portugal, Rumania, Singapore, Slovak Republic, Spain, Sweden, Switzerland, Thailand, Turkey, United Kingdom, Viet Nam, etc.

PAL-M system

Brazil

PAL-N system

Argentina, Paraguay, Uruguay

SECAM system

Bulgaria, France, Greece, Guiana, Iran, Iraq, Monaco, Russia, Ukraine, etc.

Table of contents

Operation Search

MENU/Settings Search

Index

Using with your computer

“PMB” and other applications are contained on the CD-ROM (supplied) to allow more versatile use of images shot with your Cyber-shot camera.

Recommended computer environment (Windows)

The following computer environment is recommended when using the supplied software “PMB” or “PMB Portable”, and importing images via a USB connection.

OS (pre-installed)	Microsoft Windows XP* ¹ SP3/Windows Vista* ² SP2/ Windows 7
Others	CPU: Intel Pentium III 800 MHz or faster Memory: 512 MB or more Hard Disk: Disk space required for installation— approximately 500 MB Display: Screen resolution: 1,024 × 768 dots or more

*¹ 64-bit editions and Starter (Edition) are not supported.

Windows Image Mastering API (IMAPI) Ver.2.0 or later is required to use the function for creating discs.

*² Starter (Edition) is not supported.

Recommended computer environment (Macintosh)

The following computer environment is recommended when using the supplied software “PMB Portable” and importing images via a USB connection.





OS (pre-installed)	USB Connection: Mac OS X (v10.3 to v10.6) PMB Portable: Mac OS X (v10.4 to v10.6)
---------------------------	--

Notes

- Operation is not assured in an environment based on an upgrade of the operating systems described above or in a multi-boot environment.
- If you connect two or more USB devices to a single computer at the same time, some devices, including the camera, may not operate, depending on the types of USB devices you are using.
- Connecting the camera using a USB interface that is compatible with Hi-Speed USB (USB 2.0 compliant) allows advanced transfer (high speed transfer), as the camera is compatible with Hi-Speed USB (USB 2.0 compliant).
- When your computer resumes activity from suspend or sleep mode, communication between the camera and your computer may not recover at the same time.

Using the software

Installing “PMB (Picture Motion Browser)” (Windows)

- 1 Turn on your computer, and insert the CD-ROM (supplied) into the CD-ROM drive.
The installation menu screen appears.
 - If it does not appear, double-click [Computer] (in Windows XP, [My Computer]) →  (SONYPMB).
 - If the AutoPlay screen appears, select “Run Install.exe” and follow the instructions that appear on the screen to proceed with the installation.
- 2 Click [Install].
The “Choose Setup Language” screen appears.
- 3 Select the desired language, then proceed to the following screen.
The “License Agreement” screen appears.
- 4 Carefully read the agreement, click the radio button (○ → ●) to accept the terms of the agreement, and then click [Next].
- 5 Follow the instructions on the screen to complete the installation.
 - For the installation, connect the camera to the computer during the procedure (page 82).
 - When the restarting confirmation message appears, restart the computer following the instructions on the screen.
 - DirectX may be installed depending on the system environment of your computer.
- 6 Remove the CD-ROM after the installation is complete.
- 7 Start up the software.
 - To start up “PMB”, click  (PMB) on the desktop.
For the detailed operation method, see the PMB Support page (<http://www.sony.co.jp/pmb-se/>) (English only) or click  (PMB Help).
 - To start up “PMB” from the Start menu, select [Start] → [All Programs] →  (PMB).

Notes

- Log on as Administrator.
- When “PMB” is started up for the first time, the confirmation message of the Information tool appears on the screen. Select [Start].

Introduction to “PMB”

- “PMB” allows you to import images shot with the camera to a computer for display. Make a USB connection between the camera and your computer, and click [Import].
- Images on a computer can be exported to a memory card, and displayed on the camera. Make a USB connection between the camera and your computer, click [Export] → [Export Media Files] in the [Manipulate] menu, and click [Export].
- You can save and print images with the date.
- You can display images stored on a computer by shooting date in a calendar display.
- You can correct (Red Eye Reduction, etc.) still images, and change the shooting date and time.
- You can create discs with CD or DVD disc-writing drive.
- You can upload images to media services. (An internet connection environment is required.)
- For other details, see  (PMB Help).

Table of
contents

Operation
Search

MENU/Settings
Search

Index

Connecting the camera to the computer

- 1 Insert a sufficiently charged battery pack into the camera.
- 2 Turn on the computer, then press  (Playback) button.
- 3 Connect the camera to your computer.
 - When a USB connection is established for the first time, your computer automatically runs a program to recognize the camera. Wait for a while.

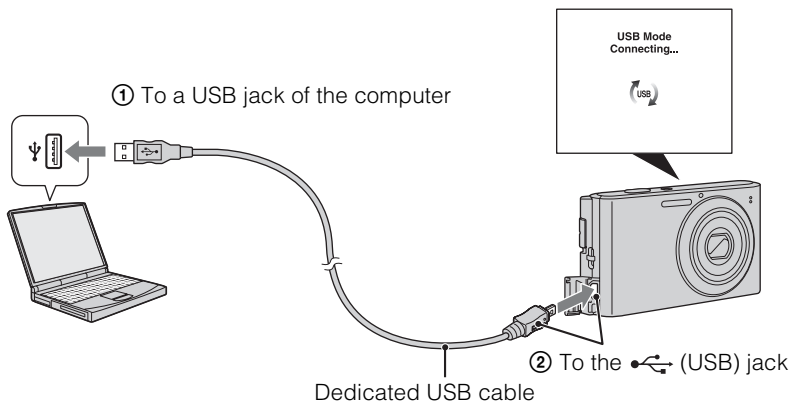

Importing images to a computer (Windows)

“PMB” allows you to easily import images.
For details on “PMB” functions, see the “PMB Help”.

Importing images to a computer without using “PMB”

When the AutoPlay Wizard appears after making a USB connection between the camera and a computer, click [Open folder to view files] → [OK] → [DCIM] → copy the desired images to the computer.

Importing images to a computer (Macintosh)

- 1 Connect the camera to your Macintosh computer first. Double-click the newly recognized icon on the desktop → [DCIM] → the folder where the images you want to import are stored.
- 2 Drag and drop the image files to the hard disk icon.
The image files are copied to the hard disk.
- 3 Double-click the hard disk icon → the desired image file in the folder containing the copied files.
The image is displayed.

Deleting the USB connection

Perform the procedures from step 1 to 3 below before:

- Disconnecting the dedicated USB cable.
- Removing a memory card.
- Inserting a memory card into the camera after copying images from the internal memory.
- Turning off the camera.

- 1 Double-click the disconnect icon on the tasktray.
- 2 Click  (USB Mass Storage Device) → [Stop].
- 3 Confirm the device on the confirmation window, then click [OK].

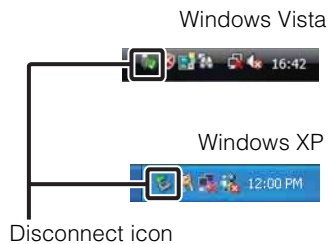

Note

- Drag and drop the icon of the memory card or the drive icon to the “Trash” icon beforehand when you use a Macintosh computer, and the camera is disconnected from the computer.

Uploading images to a media service

This camera has a built-in application “PMB Portable”.

You can use this application to do the following:

- You can easily upload images to a blog or other media service.
- You can upload images from a computer connected to the Internet even when you are away from home or the office.
- You can easily register the media services (such as blogs) you use frequently.

For details on “PMB Portable”, see the “PMB Portable” help.

Starting up “PMB Portable” (Windows)

When using “PMB Portable” for the first time, you must select the language. Follow the procedure below to make the selection. Once the language selection has been made, steps 3 to 5 are unnecessary the next time you use “PMB Portable”.

1 Make a USB connection between the camera and a computer.

When you connect the camera and your computer, the AutoPlay Wizard appears.

Click [×] to close any unnecessary drives.

- If the desired AutoPlay Wizard does not appear, click [Computer] (in Windows XP, [My Computer]) → [PMBPORTABLE], then double-click “PMBP_Win.exe”.

2 Click “PMB Portable”.

(In Windows XP, click “PMB Portable” → [OK].)

- If [PMB Portable] is not displayed within the AutoPlay Wizard, click [Computer] → [PMBPORTABLE], then double-click “PMBP_Win.exe”.

The Language Selection screen appears.

3 Select the desired language, then click [OK].

The Region Selection screen appears.

4 Select the appropriate [Region] and [Country/Area], and then click [OK].

The User Agreement screen appears.

5 Read the agreement carefully. If you accept the terms of the agreement, click [I Agree].

“PMB Portable” starts up.

Starting up “PMB Portable” (Macintosh)

- 1 Make a USB connection between the camera and a Macintosh computer.
When you connect the camera and your computer, [PMBPORTABLE] appears on the desktop.
Click [×] to close any unnecessary drives.
- 2 Click [PMBP_Mac] in the [PMBPORTABLE] folder.
The Region Selection screen appears.
- 3 Select the appropriate [Region] and [Country/Area], and then click [OK].
The User Agreement screen appears.
- 4 Read the agreement carefully. If you accept the terms of the agreement, click [I Agree].
“PMB Portable” starts up.

Notes

- Set [LUN Settings] in [Main Settings] to [Multi].
- Always connect to a network when using “PMB Portable”.
- When uploading images over the Internet, the cache may remain in the computer being used depending on the service provider. This is also true when this camera is used for this purpose.
- When a bug occurs in “PMB Portable” or you delete “PMB Portable” by mistake, you can repair “PMB Portable” by downloading the PMB Portable installer from the website.

Notes on “PMB Portable”

“PMB Portable” makes it possible to download the URLs of a number of websites from the server administered by Sony (the “Sony server”).

In order to use “PMB Portable” to enjoy the benefits of the image uploading service or other services (the “services”) provided by these and other websites, you must consent to the following.

- Some websites require registration procedures and/or fees to use their services. In using such services, you must comply with the terms and conditions established by the websites concerned.
- Services may be terminated or changed in accordance with the convenience of the website operators. Sony will not be held responsible for any trouble occurring between the users and third parties or any inconvenience caused to users relating to the utilization of the services inclusive of the termination of or changes to such services.
- To view a website, you will be redirected to it by the Sony server. There may be times when you cannot access the website because of server maintenance or for other reasons.
- If the operation of the Sony server is to be terminated, you will be notified of the termination ahead of time on Sony’s website, etc.
- The URLs to which you are redirected by the Sony server and other information may be recorded for the purposes of improving Sony’s future products and services. However, no personal data will be recorded on such occasions.

Printing still images

You can print still images using the following methods.

- Printing directly using a PictBridge-compliant printer
- Printing directly using a printer which supports your memory card type.
For details, see the operating instructions supplied with the printer.
- Printing using a computer
You can import images to a computer using the supplied “PMB” software and print the images.
You can insert the date on the image and print it. For details, see the “PMB Help”.
- Printing at a shop (page 87)

Note

- When you print still images shot in [16:9] mode, both edges may be cut off.

Printing images directly using a PictBridge-compliant printer

Even if you do not have a computer, you can print images shot using the camera by connecting the camera directly to a PictBridge-compliant printer.

PictBridge “PictBridge” is based on the CIPA standard. (CIPA: Camera & Imaging Products Association)

- 1 Insert a sufficiently charged battery pack into the camera.
- 2 Connect the camera to the printer.

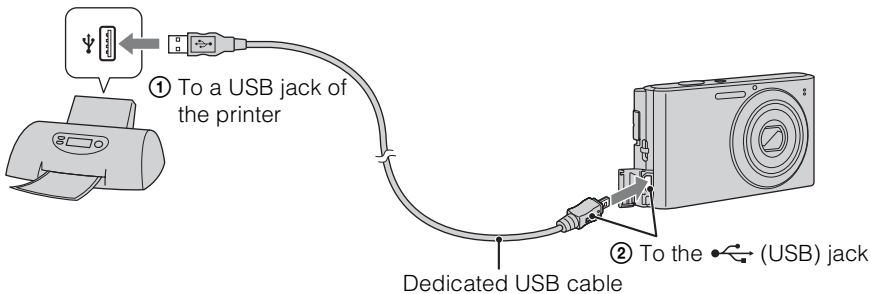

- 3 Turn on the camera and the printer.

After the connection is made, the  indicator appears on the screen.

If the  indicator flashes on the screen of the camera (error notification), check the connected printer.



4 MENU →  (Print) → desired mode → ● on the control button

This Image	Prints the currently displayed image in single-image mode.
Multiple Images	You can select and print multiple images. After step 4, perform the following. ① Select an image then press ●. Repeat the above steps until there are no more images to be printed. ② MENU → [OK] → ●

5 Desired item → [Start] → ●

Quantity	Selects the number of copies of the specified image to be printed. <ul style="list-style-type: none">The designated number of images may not all fit onto a single sheet depending on the quantity of images.
Layout	Selects the number of images you want to print side by side on a sheet.
Size	Selects the size of the printing sheet.
Date	Selects [Date] or [Day&Time] to insert the date and time on images. <ul style="list-style-type: none">When you choose [Date], the date will be inserted in the order you have selected using [Date & Time Setting] on the camera. This function may not be available depending on the printer.

Notes

- Movies cannot be printed.
- If the camera could not be connected to the printer, be sure to set [USB Connect] under  (Main Settings) to [PictBridge].
- Do not disconnect the dedicated USB cable while the  (PictBridge Connecting) indicator appears on the screen.

Printing at a shop

You can take a memory card containing images shot with the camera to a photo printing service shop. As long as the shop supports photo printing services conforming to DPOF, you can make a **DPOF** (Print order) mark on images in advance in the playback mode so that you do not have to reselect them when you print them out at the shop.

Notes

- You cannot print images stored in the internal memory at a print shop directly from the camera. Copy the images to a memory card (page 74), then take the memory card to the print shop.
- Consult your photo printing service shop as to what types of memory card they handle.
- A memory card adaptor (sold separately) may be necessary. Consult your photo printing service shop.
- Before you take image data to a shop, always copy (back up) your data to a disk.
- You cannot set the number of prints.
- If you want to superimpose dates on images, consult your photo printing service shop.

Troubleshooting

If you experience trouble with the camera, try the following solutions.

❶ Check the items on pages 88 to 95.

If a code such as “C/E:□□:□□” appears on the screen, see page 96.

❷ Remove the battery, wait for about one minute, re-insert the battery, then turn on the power.

❸ Initialize the settings (page 66).

❹ Consult your Sony dealer or local authorized Sony service facility.

Be aware that by sending the camera for repair, you give consent that the contents of the internal memory, music files may be checked.

Additional information on this product and answers to frequently asked questions can be found at our Customer Support Website.
<http://www.sony.net/>

Battery pack and power

Cannot insert the battery pack.

- Insert the battery pack correctly by pushing the battery eject lever.

Cannot turn on the camera.

- After inserting the battery pack into the camera, it may take a few moments for the camera to power up.
- Insert the battery pack correctly.
- The battery pack is discharged. Insert a charged battery pack.
- Use a recommended battery pack.

The power turns off suddenly.

- Depending on the camera and battery temperature, the power may turn off automatically to protect the camera. In this case, a message is displayed on the LCD screen before the power turns off.
- When [Power Save] is set to [Standard] or [Stamina], if you do not operate the camera for a certain period of time while the power is on, the camera turns off automatically to prevent wearing down the battery pack. Turn on the camera again.

The remaining charge indicator is incorrect.

- This phenomenon occurs when you use the camera in an extremely hot or cold location.
- A discrepancy arose between the remaining charge indicator and the actual remaining battery charge. Fully discharge the battery pack once, then charge it to correct the indication. The indicator may not be accurate depending on the conditions of use.
- The battery pack is dead (page 101). Replace it with a new one.

Cannot charge the battery pack.



- You cannot charge the battery pack using the AC Adaptor (sold separately). Use the battery charger to charge the battery.

The CHARGE lamp flashes while charging the battery.

- Remove and reinsert the battery pack, making sure it is installed correctly.
- The temperature may be inappropriate for charging. Try charging the battery pack again within the proper charging temperature range (10°C to 30°C (50°F to 86°F)).
- Refer to page 102 for details.

Shooting still images/movies



Cannot record images.

- Images are recorded on the internal memory even when a memory card is inserted into the camera. Make sure that the memory card is fully inserted into the camera.
- Check the free capacity of the internal memory or memory card. If it is full, do one of the following:
 - Delete unnecessary images (page 26).
 - Change the memory card.
- You cannot record images while charging the flash.
- When recording movies, it is recommended that you use the following memory cards:
 - “Memory Stick PRO Duo” media, “Memory Stick PRO-HG Duo” media
 - SD memory card or SDHC memory card (Class 2 or faster)
- Set the mode switch to  (Still Image) when shooting still images.
- Set the mode switch to  (Movie) when shooting movies.

Smile Shutter function does not work.

- No image is shot if a smiling face is not detected.

The image is out of focus.

- The subject is too close. When shooting, make sure to position the lens farther away from the subject than the shortest shooting distance (approximately 4 cm (1 5/8 inches) (W)/60 cm (23 5/8 inches) (T) from the lens).
-  (Twilight) or  (Landscape) mode is selected in the Scene Selection when shooting still images.









Zoom does not work.

- You cannot use the optical zoom when shooting movies.
- You cannot use the Smart zoom depending on the image size (page 60).
- You cannot use the digital zoom when:
 - Shooting movies.
 - The Smile Shutter is working.

Cannot select the Face Detection function.

- You can select Face Detection only when the focus mode is set to [Multi AF] and the metering mode is set to [Multi].



The flash does not work.

- You cannot use the flash when:
 - Burst mode is selected (page 37).
 -  (High Sensitivity) or  (Twilight) mode is selected in Scene Selection.
 - Shooting in Movie Mode.
- Set the flash to  (On) (page 20) when the Scene Selection mode is set to  (Landscape),  (Gourmet),  (Pet),  (Beach),  (Snow) or  (Underwater) mode.

Fuzzy white circular spots appear in images shot using the flash.

- Particles (dust, pollen, etc.) in the air reflected the flash light and appeared in the image. This is not a malfunction.

The close-up shoot function (Macro) does not work.

- The camera automatically adjusts the focus. Press and hold the shutter button halfway down. Focus adjustment may take some time when shooting a close subject.
-  (Landscape) or  (Twilight) mode is selected in the Scene Selection.

The date and time are not displayed on the LCD screen.

- While shooting, the date and time are not displayed. They are displayed only during playback.

Cannot insert dates on images.

- This camera does not have a feature for superimposing dates on images. By using “PMB”, you can print or save images with the date (page 80).

The F value and shutter speed flash when you press and hold the shutter button halfway down.

- The exposure is incorrect. Correct the exposure (page 38).

The image colors are not correct.

- Adjust the White Balance (page 40).

White or purple streaks appear in bright areas of the subject, or the whole screen of the image becomes reddish.

- This phenomenon is called smearing. This is not a malfunction. Smearing is not recorded on still images, but is recorded as streaks or uneven colors on movies.
(“Bright areas” refers to the sun or electric lights which are much brighter than surroundings.)

Noise appears in the image when you view the screen in a dark place.

- The camera is attempting to increase the visibility of the screen by temporarily brightening the image under conditions of low illumination. There is no effect on the recorded image.

The eyes of the subject come out red.

- Set [Red Eye Reduction] to [Auto] or [On] (page 61).
- Shoot the subject at a distance closer than the flash range using the flash.
- Light the room and shoot the subject.
- Retouch the image using [Retouch] → [Red Eye Correction] in viewing menu (page 53), or correct using “PMB”.

Dots appear and remain on the screen.

- This is not a malfunction. These dots are not recorded.

Cannot shoot images in succession.

- The internal memory or memory card is full. Delete unnecessary images (page 26).
- The battery level is low. Insert a charged battery pack.

The same image is shot several times.

- [Burst Settings] is set to [Burst] (page 37).
- [Scene Recognition] is set to [Advanced] (page 45).

Viewing images

Cannot play back images.

- Make sure that the memory card is fully inserted into the camera.
- The folder/file name has been changed on your computer.
- No guarantees are made for playing back, on this camera, files containing images which were processed on a computer or images which were shot using other cameras.
- The camera is in USB mode. Delete the USB connection (page 83).

The date and time are not displayed.

- The screen display is set to display images only. Press the DISP (Screen Display Settings) button to display information (page 19).

The image appears rough right after playback starts.

- This may happen due to image processing. This is not a malfunction.

The image does not appear on the LCD screen.

- If an A/V cable is connected to the camera, disconnect it.

Cannot display images in index mode.

- The camera is set to Easy Mode. Cancel Easy Mode.

The image does not appear on the TV.

- Check [Video Out] to see if the video output signal of the camera is set to the color system of your TV (page 67).
- Check whether the connection is correct (page 77).

Deleting

Cannot delete an image.

- Cancel the protection (page 55).

Computers

“Memory Stick PRO Duo” media is not recognized by a computer with a “Memory Stick” media slot.

- Check that the computer and the “Memory Stick” media Reader/Writer support “Memory Stick PRO Duo” media. Users of computers and “Memory Stick” media Readers/Writers made by manufacturers other than Sony should contact those manufacturers.
- If “Memory Stick PRO Duo” media is not supported, connect the camera to the computer (page 82). The computer recognizes the “Memory Stick PRO Duo” media.

Your computer does not recognize the camera.

- When the battery level is low, insert the charged battery pack.
- Set [USB Connect] to [Auto] or [Mass Storage] (page 68).
- Use the dedicated USB cable (supplied).
- Disconnect the dedicated USB cable from both the computer and the camera, and connect it again firmly.
- Disconnect all equipment other than the camera, the keyboard and the mouse from the USB connectors of your computer.
- Connect the camera directly to your computer without passing through a USB hub or other device.

Cannot import images.

- Connect the camera and your computer correctly making a USB connection (page 82).
- When you shoot images with a memory card formatted by a computer, you may not be able to import the images to a computer. Shoot using a memory card formatted by the camera (page 70).

After making a USB connection, “PMB” does not start automatically.

- Make the USB connection after the computer is turned on.

After making a USB connection, “PMB Portable” does not start.

- Set [LUN Settings] to [Multi] (page 69).
- Set [USB Connect] to [Auto] or [Mass Storage] (page 68).
- Connect the computer to the network.

Cannot play back images on your computer.

- If you are using “PMB”, refer to “PMB Help” (page 80).
- Consult the computer or software manufacturer.

The image and sound are interrupted by noise when you view a movie on a computer.

- You are playing back the movie directly from the internal memory or the memory card. Import the movie to your computer using “PMB” and play it back. (page 82).

Images once exported to a computer cannot be viewed on the camera.

- Export them to a folder recognized by the camera, such as “101MSDCF”.

Memory card

Cannot insert a memory card.

- Insert the memory card in the correct direction.

You have formatted a memory card by mistake.

- All the data on the memory card is deleted by formatting. You cannot restore it.

Images are recorded on the internal memory even when a memory card is inserted into the camera.

- Make sure that the memory card is fully inserted into the camera.

Internal memory

Cannot play back or record images using the internal memory.

- There is a memory card inserted in the camera. Remove it.

Cannot copy the data stored in the internal memory to a memory card.

- The memory card is full. Copy to a memory card with sufficient capacity.

Cannot copy the data on the memory card or the computer to the internal memory.

- This feature is not available.

Printing

See “PictBridge-compliant printer” together with the following items.

Cannot print an image.

- Refer to the operation manual of the printer.

Images are printed with both edges cut off.

- Depending on your printer, all the edges of the image may be cut off. Especially when you print an image shot with the image size set to [16:9], the lateral end of the image may be cut off.
- When printing images using your printer, cancel the trimming or borderless settings. Consult the printer manufacturer as to whether the printer provides these functions or not.
- When having images printed at a digital print shop, ask the shop whether they can print the images without cutting off both edges.

Cannot print images with the date.

- Using “PMB”, you can print images with date (page 80).
- The camera does not have a feature for superimposing dates on images. However, because the images shot with the camera include information on the recording date, you can print images with the date superimposed if the printer or the software can recognize Exif information. For compatibility with Exif information, consult the manufacturer of the printer or the software.
- If you use a photo printing service, ask them to superimpose the dates on images.

PictBridge-compliant printer

A connection cannot be established.

- The camera cannot be connected directly to a printer that is not compliant with the PictBridge standard. Consult the printer manufacturer as to whether the printer is compliant with PictBridge or not.
- Check that the printer is turned on and can be connected to the camera.
- Set [USB Connect] to [PictBridge] (page 68).
- Disconnect and connect the dedicated USB cable again. If an error message is indicated on the printer, refer to the operating instructions supplied with the printer.

Cannot print images.

- Check that the camera and the printer are properly connected using the dedicated USB cable.
- Turn on the printer. For details, refer to the operating instructions supplied with the printer.
- If you select [Exit] during printing, images may not be printed. Disconnect and connect the dedicated USB cable again. If you still cannot print your images, disconnect the dedicated USB cable, turn the printer off and then on, then connect the dedicated USB cable again.
- Movies cannot be printed.
- Images shot using other cameras, or images modified with a computer may not be printed.

Printing is canceled.

- Confirm that you have disconnected the dedicated USB cable before the  (PictBridge Connecting) mark disappears.

Cannot insert the date or print images in the index mode.

- The printer does not provide these functions. Consult the printer manufacturer as to whether the printer provides these functions or not.
- The date may not be inserted in the index mode depending on the printer. Consult the printer manufacturer.

“---- -- --” is printed on the date-inserted part of the image.

- The image does not have the recording data so the date cannot be inserted. Set [Date] to [Off] and print the image again (page 86).

Cannot print the image at the size selected.

- When you use paper of a different size after connecting the printer to the camera, disconnect and then reconnect the dedicated USB cable.
- The print setting of the camera differs from that of the printer. Change the setting of either the camera (page 86) or the printer.
- Consult the printer manufacturer as to whether the printer can provide the desired size.

Cannot operate the camera after cancelling printing.

- Wait for a while as the printer is carrying out the cancellation. It may take some time depending on the printer.

Others

The lens gets fogged.

- Moisture condensation has occurred. Turn off the camera and leave it for about an hour before using it.

The camera turns off with the lens portion extended.

- The battery pack is discharged. Replace it with a charged battery pack, then turn the camera on again.
- Do not attempt to force the lens that has stopped moving.

The camera becomes warm when you use it for a long time.

- This is not a malfunction.

The Clock Set screen appears when you turn on the camera.

- Set the date and time again (page 76).
- The internal rechargeable backup battery has discharged. Insert a charged battery, and set aside for 24 hours or more with the power left off.

The date or time is incorrect.

- Change the setting by MENU →  (Settings) → [Clock Settings] → [Date & Time Setting].

Warning indicators and messages

Self-diagnosis display

If a code starting with a letter of the alphabet appears, the self-diagnosis function on the camera is working. The last two digits (indicated by □□) will differ depending on the state of the camera.

If you cannot solve the problem even after trying the following corrective actions a few times, the camera may need repair.

Contact your Sony dealer or local authorized Sony service facility.

C:32:□□

- There is trouble with the camera's hardware. Turn the power off and on again.

C:13:□□

- The camera cannot read or write data on the memory card. Try turning off and on the camera again, or taking out and inserting the memory card several times.
- The internal memory has experienced a format error, or an unformatted memory card is inserted. Format the internal memory or the memory card (page 70).
- The inserted memory card cannot be used with the camera, or the data is damaged. Insert a new memory card.

E:61:□□

E:62:□□

E:91:□□

- A camera malfunction has occurred. Initialize the camera (page 66), then turn the power on again.

Messages

If the following messages appear, follow the instructions.



- The battery level is low. Charge the battery pack immediately. Depending on the conditions of use or the type of battery, the indicator may flash even though there are still 5 to 10 minutes of remaining battery time left.

For use with compatible battery only

- The battery inserted is not an NP-BN1 (supplied) battery pack.

System error

- Turn the power off and then on again.

Camera overheating

Allow it to cool

- The camera temperature has risen. The power may turn off automatically, or you may be unable to record movies. Leave the camera in a cool location until the temperature goes down.

Internal memory error

- Turn the power off and then on again.

Reinsert the memory card

- The inserted memory card cannot be used in the camera (page 3).
- The terminal section of the memory card is dirty.
- The memory card is damaged.

Memory card type error

- The inserted memory card cannot be used in the camera (page 3).

Error formatting internal memory

Error formatting memory card

- Format the media again (page 70).

Memory card locked

- You are using the memory card with the write-protect switch, and the switch is set to the LOCK position. Set the switch to the recording position.

Read only memory card

- The camera cannot record or delete images on this memory card.

No images

- No images that can be played back have been recorded in the internal memory.
- No images that can be played back have been recorded in this folder of the memory card.

Folder error

- A folder with the same first three digit number already exists on the memory card (for example: 123MSDCF and 123ABCDE). Select another folder, or create a new folder (pages 71, 72).

Cannot create more folders

- The folder with a name beginning with “999” exists on the memory card. You cannot create any folders if this is the case.

File error

- An error occurred while the image was playing back.
No guarantees are made for playing back, on this camera, files containing images which were processed on a computer or images which were shot using other cameras.

Read only folder

- You have selected a folder that cannot be set as a recording folder on the camera. Select another folder (page 72).

File protected

- Release the protection (page 55).

Image size over limit

- You are playing back an image with size that cannot be played back on the camera.

Unable to detect face for retouch

- You may not be able to retouch the image depending on the image.

(Vibration warning indicator)

- Camera shake may occur due to insufficient light. Use the flash, or mount the camera on a tripod to secure the camera.

Turn the power off and on again

- The lens malfunction.

VGA is not supported with this memory card

- For recording movies, it is recommended that you use a memory card of 1 GB or larger.

Maximum number of images already selected

- Up to 100 files can be selected when using [Multiple Images].
- You can add **DPOF** (Print order) marks to up to 999 files. Cancel the selection.



- The data transmission to the printer may not be completed yet. Do not disconnect the dedicated USB cable.

Processing...

- The printer is canceling the current print job. You cannot print until it is finished. This may take time, depending on the printer.

Operation cannot be executed in unsupported files

- Processing and other editing functions of the camera cannot be performed on image files that have been processed using a computer or images that were recorded with other cameras.

No internal memory space remaining

Delete images?

- The internal memory is full. To record to the internal memory, select [Yes] and delete unwanted images.

“Memory Stick Duo” media

A “Memory Stick Duo” media is a compact, portable IC recording medium. The types of “Memory Stick Duo” media that can be used with the camera are listed in the table below. However, proper operation cannot be guaranteed for all “Memory Stick Duo” media functions.

“Memory Stick” media type	Recording/Playback
Memory Stick Duo (without MagicGate)	○* ¹
Memory Stick Duo (with MagicGate)	○* ²
MagicGate Memory Stick Duo	○* ¹ * ²
Memory Stick PRO Duo	○* ² * ³
Memory Stick PRO-HG Duo	○* ² * ³ * ⁴

*¹ High-speed data transfer using a parallel interface is not supported.

*² “Memory Stick Duo” media, “MagicGate Memory Stick Duo” media and “Memory Stick PRO Duo” media are equipped with MagicGate functions. MagicGate is copyright protection technology that uses encryption technology. Data recording/playback that requires MagicGate functions cannot be performed with the camera.

*³ [VGA] size movies can be recorded.

*⁴ This camera does not support 8-bit parallel data transfer. It performs the same 4-bit parallel data transfer as the “Memory Stick PRO Duo” media.

Notes

- This product is compatible with “Memory Stick Micro” media (“M2”). “M2” is an abbreviation for “Memory Stick Micro” media.
- A “Memory Stick Duo” media formatted with a computer is not guaranteed to operate with the camera.
- Data read/write speeds differ depending on the combination of the “Memory Stick Duo” media and the equipment used.
- Do not remove the “Memory Stick Duo” media while reading or writing data.
- Data may be corrupted in the following cases:
 - When the “Memory Stick Duo” media is removed or the camera is turned off during a read or write operation
 - When the “Memory Stick Duo” media is used in locations subject to static electricity or electrical noise
- We recommend backing up important data.
- Do not attach a label on the “Memory Stick Duo” media itself nor on a “Memory Stick Duo” media Adaptor.
- Do not touch the terminal section of the “Memory Stick Duo” media with your hand or a metal object.
- Do not strike, bend or drop the “Memory Stick Duo” media.
- Do not disassemble or modify the “Memory Stick Duo” media.
- Do not expose the “Memory Stick Duo” media to water.
- Do not leave the “Memory Stick Duo” media within the reach of small children. They might accidentally swallow it.
- Do not insert anything other than a “Memory Stick Duo” media into the “Memory Stick Duo” media slot. Doing so will cause a malfunction.
- Do not use or store the “Memory Stick Duo” media under the following conditions:
 - High temperature locations such as the hot interior of a car parked in direct sunlight
 - Locations exposed to direct sunlight
 - Humid locations or locations with corrosive substances present

Notes on using the “Memory Stick Duo” media Adaptor (sold separately)

- To use a “Memory Stick Duo” media with a “Memory Stick” media compliant device, be sure to insert the “Memory Stick Duo” media into a “Memory Stick Duo” media Adaptor. If you insert a “Memory Stick Duo” media into a “Memory Stick” media compliant device without a “Memory Stick Duo” media Adaptor, you might not be able to remove it from the device.
- When inserting a “Memory Stick Duo” media into a “Memory Stick Duo” media Adaptor, make sure the “Memory Stick Duo” media is inserted facing in the correct direction, then insert it all the way in. Incorrect insertion may result in a malfunction.
- When using a “Memory Stick Duo” media inserted into a “Memory Stick Duo” media Adaptor with a “Memory Stick” media compliant device, make sure that the “Memory Stick Duo” media Adaptor is inserted facing the correct direction. Note that improper use may damage the equipment.
- Do not insert a “Memory Stick Duo” media Adaptor into a “Memory Stick” media compliant device without a “Memory Stick Duo” media attached. Doing so may result in malfunction of the unit.

Notes on using “Memory Stick Micro” media (sold separately)

- To use a “Memory Stick Micro” media with the camera, be sure to insert the “Memory Stick Micro” media into an “M2” Adaptor as large as of Duo size. If you insert a “Memory Stick Micro” media into the camera without an “M2” Adaptor as large as of Duo size, you might not be able to remove it from the camera.
- Do not leave the “Memory Stick Micro” media within the reach of small children. They might accidentally swallow it.

Battery pack

On charging the battery pack

We recommend charging the battery pack in an ambient temperature of between 10°C to 30°C (50°F to 86°F). The battery pack may not be effectively charged in temperatures outside this range.

Effective use of the battery pack

- Battery performance decreases in low temperature surroundings. So in cold places, the operational time of the battery pack is shorter. We recommend the following to ensure longer battery pack use:
 - Put the battery pack in a pocket close to your body to warm it up, and insert it in the camera immediately before you start shooting.
- The battery pack will run out quickly if you use the flash or zoom frequently.
- We recommend having spare battery packs handy for two or three times the expected shooting time, and making trial shots before taking the actual shots.
- Do not expose the battery pack to water. The battery pack is not water-resistant.
- Do not leave the battery pack in extremely hot places, such as in a car or under direct sunlight.

How to store the battery pack

- Fully discharge the battery pack before storing and store it in a cool, dry place. To maintain the battery pack's function, fully charge the battery pack and then fully discharge it on the camera at least once a year while storing.
- To use the battery pack up, leave the camera in slideshow playback mode until the power goes off.
- To prevent staining the terminal, short-circuiting, etc., be sure to use a plastic bag to keep away from metal materials when carrying or storing.

On battery life

- The battery life is limited. Battery capacity decreases over time and through repeated use. If decreased usage time between charges becomes significant, it is probably time to replace it with a new one.
- The battery life varies according to how it is stored and the operating conditions and environment in which each battery pack is used.

Compatible battery pack

- The NP-BN1 (supplied) can be used only in N type compatible Cyber-shot models.

Battery charger

- Only NP-BN type battery packs (and no others) can be charged in the battery charger (supplied). Batteries other than the specified kind may leak, overheat, or explode if you attempt to charge them, posing a risk of injury from electrocution and burns.
- Remove the charged battery pack from the battery charger. If you leave the charged battery pack in the charger, battery life may be shortened.
- The CHARGE lamp of the supplied battery charger flashes in either way:
 - Fast flashing: Turns the light on and off repeatedly at the interval of 0.15 seconds.
 - Slow flashing: Turns the light on and off repeatedly at the interval of 1.5 seconds.
- When the CHARGE lamp flashes fast, remove the battery pack being charged, and then insert the same battery pack into the battery charger securely again. When the CHARGE lamp flashes fast again, this may indicate a battery error or that a battery pack other than the specified type has been inserted. Check that the battery pack is the specified type. If the battery pack is the specified type, remove the battery pack, replace it with a new one or another one and check if the battery charger operates correctly. If the battery charger operates correctly, a battery error may have occurred.
- When the CHARGE lamp flashes slowly, it indicates that the battery charger stops charging temporarily on standby. The battery charger stops charging and enters the standby status automatically when the temperature is outside of the recommended operating temperature. When the temperature gets back within the appropriate range, the battery charger resumes charging and the CHARGE lamp lights up again. We recommend charging the battery pack in an ambient temperature of between 10°C to 30°C (50°F to 86°F).

Index

A

AF range finder frame42

B

Battery charger102

Battery pack101

Beach31

Beep62

Burst Settings37

C

CD-ROM80

Center AF42

Center-weighted metering44

Change REC.Folder72

Changing the display19

Clock Settings76

Computer79

 Importing images82

Connecting

 Computer82

 Printer86

 TV77

Control button13

Copy74

Create REC.Folder71

D

Date & Time Setting76

Delete26, 54

Delete REC.Folder73

Digital Zoom60

DISP19

DPOF56

DRO50

E

Easy Mode

 Shooting34

 Viewing51

EV38

Exposure38

F

Face Detection48

File Number75

Flash20

Focus42

Folder

 Changing72

 Creating71

 Deleting73

 Selecting58

Format70

Function Guide64

G

Gourmet31

Grid Line59

H

High Sensitivity31

I

Identifying parts13

Image Index25

Image Size35

Initialize66

Install80

Intelligent Auto Adjustment29

Internal memory17

ISO39

L

Landscape31

Language Setting63

LUN Settings69

M

Macintosh computer79

Mass Storage68

Memory card3

“Memory Stick Duo” media99

MENU10

Metering Mode44

Mode switch16

Movie.....	16	Shooting	
MTP.....	68	Movie.....	16
Multi AF.....	42	Still image.....	29
Multi-pattern metering.....	44	Slideshow.....	52
N		Slow Synchro.....	20
NTSC.....	67	Smart zoom.....	60
O		Smile Detection Sensitivity.....	47
Optical zoom.....	18, 60	Smile Shutter.....	21
OS.....	79	Snow.....	31
P		Soft Snap.....	31
PAL.....	67	Software.....	80
PC.....	79	Spot AF.....	42
Pet.....	31	Spot metering.....	44
PictBridge.....	68, 86	SteadyShot.....	33
Pixel.....	36	T	
Playback.....	23	Trimming.....	53
Playback zoom.....	24	Troubleshooting.....	88
PMB.....	80	TV.....	77
PMB Portable.....	84	Twilight.....	31
Power Save.....	65	Twilight Portrait.....	31
Precision digital zoom.....	60	U	
Print.....	56, 86	Underwater.....	31
Print order mark.....	56, 87	Underwater White Balance.....	41
Program Auto.....	30	USB Connect.....	68
Protect.....	55	USB jack.....	13, 82, 86
PTP.....	68	V	
R		VGA.....	35
REC Mode.....	28	Video Out.....	67
Red Eye Correction.....	53	W	
Red Eye Reduction.....	61	Warning messages.....	96
Retouch.....	53	White Balance.....	40
Rotate.....	57	Windows computer.....	79
S		Z	
Scene Recognition.....	45	Zoom.....	18
Scene Selection.....	31		
Screen.....	19		
Select Folder.....	58		
Self-diagnosis display.....	96		
Self-Timer.....	22		
Settings.....	12		