

DVR 840XHD

Digital Video Camcorder

Owner's Manual



Vivitar®

© 2009 Sakar International, Inc. All rights reserved.

Windows and the Windows logo are registered trademarks of Microsoft Corporation.
All other trademarks are the property of their respective companies.

Table of Contents

Introduction.....	2
Key Features	2
What your digital video camera includes	3
Computer System Requirements for Windows XP	4
Computer System Requirement for Windows Vista	4
A Quick Look at your Digital Video Camcorder	5
Preparing Your Camera for Use.....	7
Inserting an SD Memory Card	8
Software Installation: Snap 'n Share Pro and Video Express	9
Software Installation.....	9
Camera Buttons and Functions	17
DVR Functions and Menu Control.....	18
Camera Playback Modes.....	53
Connecting to a High Definition TV to view images.....	73
Connecting to a non High Definition TV to view images	74
Transferring Images to your PC using the software	75
Manually transfer media to your Digital Camera	83
Everything you need to get the most of your media and MORE.....	84
Video Express application.....	88
Technical Support.....	96
Sakar Warranty Card	96
Technical Specifications	98

Introduction

Thank you for purchasing the DVR 840XHD Digital Video Camcorder. With your camera you can shoot high resolution H.264 video clips and take individual photos. In addition, 128 MB built-in memory allows you to take pictures and short movies without a memory card. However a SD compatible memory card of up to 8GB should to be inserted in order to expand the memory of your DVR camera. You can also connect it to an HDTV via the provided HDMI cable, and easily playback recorded high-definition videos directly on the wide screen HDTV.

Key Features

- 5 Digital Video resolutions – 1440x1080 Pixels (HD), 1280x720p (HD), 848x480p (WVGA), 640x480p (VGA) and 320x240 (QVGA).
- 8 mega-pixels camera with choice of 3 digital camera resolutions- High 3200x2400 (8M), Standard 2592x1944 (5M) and Low 2048x1536p (3M)
- 3" TFT LCD

- 5 X Optical Zoom Lens
- Supports external SD memory card up to 8GB
- Built-in Microphone
- Snap 'n Share Pro software application can be used to download the photos and videos from your camera with the touch of a button
- Edit, add text, clipart and more on your digital photos
- Produce colorful movies to upload, copy to CD/DVD and much more with Video Express software.

What your digital video camera includes

- Digital Video Camcorder
- USB cable
- AV cable
- HDMI Cable
- Power Adapter
- Lithium-ion Rechargeable Battery
- Snap n Share Pro Software installation CD
- Quick Start Guide
- Built-in wrist strap

Computer System Requirements for Windows XP

To be able to download photos and videos to your PC you will need the following minimum configuration:

- Pentium 4 Processor (or above), 2.6 GHZ., with Windows XP Service Pack 2
- 512 MB RAM, 200MB free disk space.
- Available USB Interface
- CD-ROM Driver
- Recommended screen resolution 1024 X 768 pixels or higher.
- 16-bit color or higher display adaptor.
- Windows Media Player 9 (or above) as default media player

Computer System Requirement for Windows Vista

To be able to download photos to your PC you will need the following minimum configuration:

- Windows Vista
- 800MHz processor and 512 MB of system memory
- 20GB hard driver with at least 15GB of available space
- Support for Super VGA graphics
- Available USB Interface
- CD-ROM driver

A Quick Look at your Digital Video Camcorder

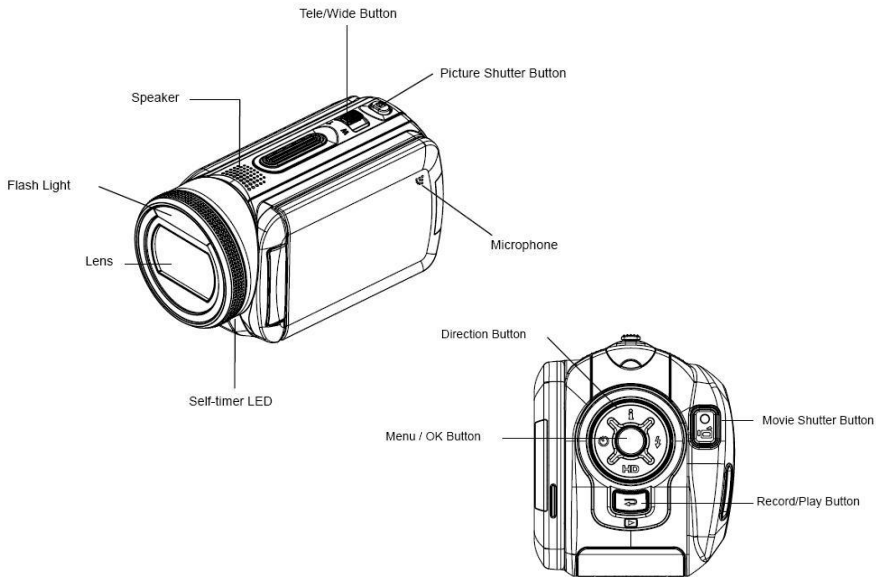

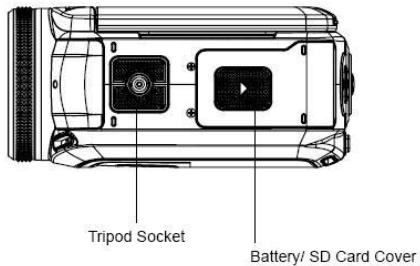
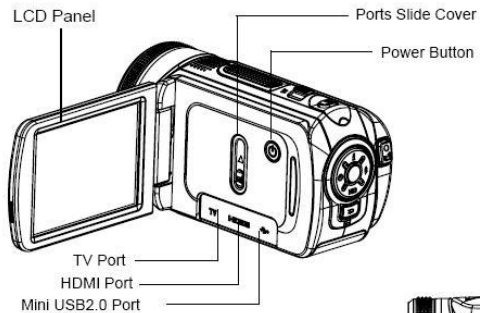





Preparing Your Camera for Use

Battery Installation

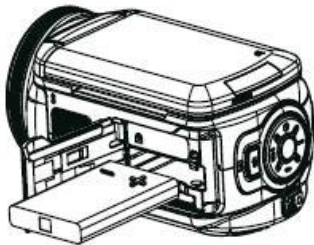
Your DVR camcorder requires a Lithium-ion rechargeable battery (included in packaging).
Open the battery compartment on the bottom of the camera.

1. Insert the batteries in accordance with the polarity (+ and -) as indicated.
2. Close the battery cover.



	Battery: full power
	Battery: medium power
	Battery: low power
	Battery: power empty

Note: You must ONLY use the supplied AC charger to recharge the battery. The camera should be Off while charging. Allow the battery to fully charge first. This should take approximately 6 hours.

The battery cannot be charged by connecting the camera via the USB cable to the USB port of your computer.

Inserting an SD Memory Card

An SD compatible memory card of up to 8GB (not included) should be inserted into your DVR camera. SD Memory cards expand the amount of memory thus allowing an increase in the number of movies and photos that can be captured before transferring them to your computer.

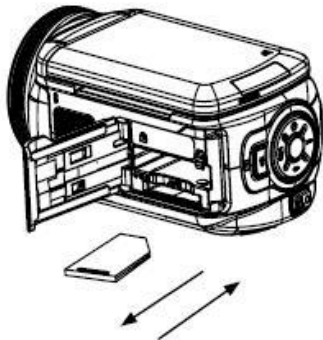

1. Locate the SD card slot in the battery compartment on the bottom of the camera.
2. Insert the SD memory card correctly in the direction shown.
3. Press the memory card until you hear a “Click” sound.

Note: After you insert an SD memory card, the  icon will appear on the LCD, indicating that your SD memory card has been installed successfully, and the media you capture will now be stored on the card and not in the internal memory.

- This product supports SD cards of up to 8GB.
- Formatting will delete all data on the SD Memory Card including protected data.
- Do not remove the SD memory Card during formatting as this may damage the card and render it unusable.
- Be sure to format the card with the camera.

Software Installation: Snap 'n Share Pro and Video Express

Follow the step by step instructions that appear on your computer screen during the installation process.

Software Installation

1. Insert the CD into your CD-Rom drive.
2. Wait for the computer to automatically recognize and open the first stage

of the software installation

3. The Welcome to the Snap 'n Share Pro Installation Wizard Setup screen will appear.

Note: On Vista operating systems you may see an AutoPlay window appear. Select the **SMSSetup.exe** option to begin the software setup.



- Click the “**Begin**” button to begin the software setup and installation process.

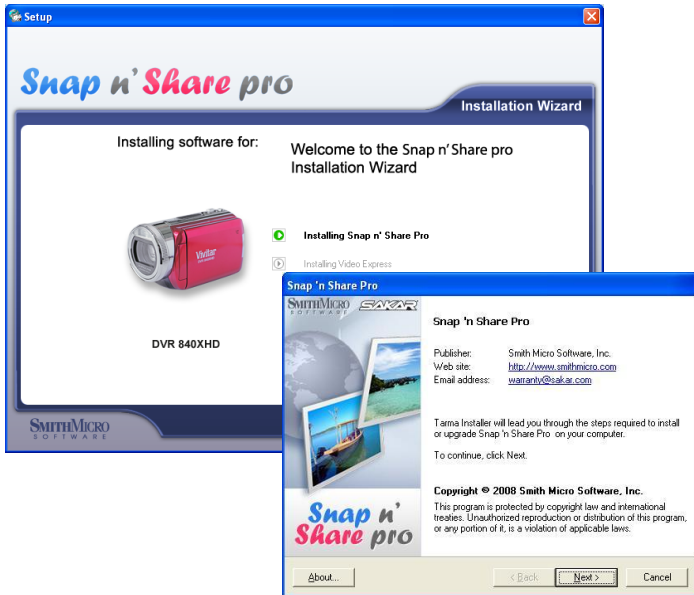

5. The Setup wizard will start to install the Snap 'n Share Pro application on your computer. Click **“Next”** to continue.

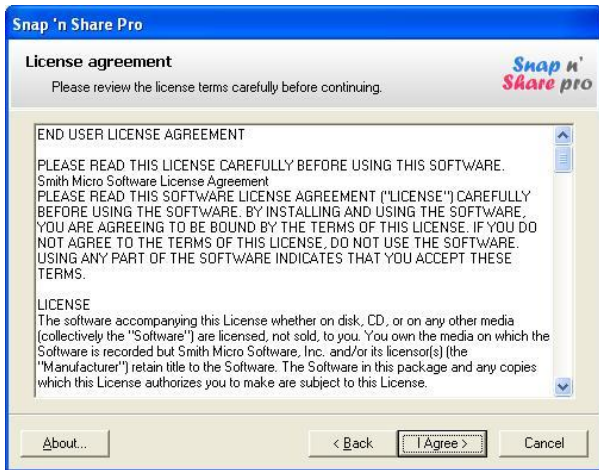

6. Please review the license terms and click the **“I Agree”** button to continue.

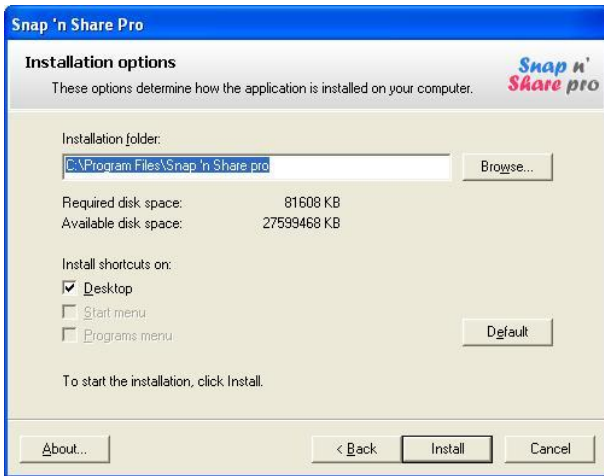

7. In the Installation options you can choose where to install this application on your computer. However, it is recommended to let the Snap 'n Share Pro installer create the folder to where the program will be installed. Click "**Install**" and follow the instructions.



8. Click **“Finish”** to let the Snap 'n Share Pro installer finish the installation program.







9. The Setup will now begin to silently install the Video Express software. This might take a few second to install depending on the operating system you are running.



Congratulations!! You have successfully installed the Snap 'n Share Pro and Video Express software on your PC.
Click the **“Finish”** button to open the Snap 'n Share Pro application.

Camera Buttons and Functions

	<p>Direction Button</p> <p>Right Button: Flash Auto/Red-Eye-Reduction/OFF</p> <p>Left Button: Self timer ON/OFF</p> <p>Up Button: LCD Information ON/OFF</p> <p>Down Button: HD(1080p) / VGA mode switch</p> <p>Menu/OK Button: Menu On / Validate the setting</p> <p>Tele Button : Zoom In</p> <p>Wide Button : Zoom out</p>
	<p>Power Button: Press down for one second to turn on or turn off the Camcorder</p>
	<p>RECORD/PLAY Button functions:</p> <ol style="list-style-type: none">1. Switch between Record /Playback Mode2. Return to the previous page3. For quick review, press it after recording
	<p>Movie Shutter Button:</p> <ol style="list-style-type: none">1. Start to take movie.2. To stop recording, press it again.
	<p>Picture Shutter Button: Start to take picture.</p>

DVR Functions and Menu Control

To power on the camera you need to flip open the LCD Screen. The Power button is situated on the inside of the camera.

Power on

Press the Power button to turn on your DVR. The green LED on the back of the camera will light up followed by the LCD monitor, indicating that your DVR is ready for use.

Power off

Press the Power button to turn your DVR camera off. The DVR camera will switch off. Alternatively, simply close the LCD panel and the camera will automatically turn off. If the DVR camera is not in use or in an operational mode for 60 seconds it will switch off automatically.

When there is insufficient battery power, a flashing red battery icon  will appear on the LCD screen. The camera will automatically power off a few moments later.

Capturing Videos





In order to start capturing videos (with audio) with your camcorder:

1. Aim the camera at the subject you wish to capture. The image you are capturing will appear on the LCD screen.
2. Press the Movie Shutter button to the right of the dial to start shooting.
3. A red flashing recording icon and the elapsed time of the video being captured will appear on the top right hand side of the LCD.
4. Use the Optical Zoom W/T on the top of the camera to zoom in or out.
5. Press the Movie Shutter button again to stop the recording.
6. The recorded file will be saved in AVI format.

Note:

1. You can view the AVI files in playback mode.
2. Once they are downloaded to the PC view them using QuickTime and Windows Media Player.
3. Please insert an SD memory card of up to 8 GB to expand the memory and capture more videos.
4. When the internal memory is full, a "MEMORY FULL" message will flash on the LCD screen when you attempt to shoot further videos.

In Video mode there are five video resolutions for you to choose from before capturing your video. The higher the resolution selected the better the quality of the video, however higher quality videos use up more memory.

Video Quality	
	HD (1080p) (30fps)
	HD (720p) (30fps)
	WVGA (60fps)
	VGA (30fps)
	QVGA (30fps)

To enter the setup submenu options for the Video mode press the OK/Menu button.



1. Press the Right/Left buttons to select the Video mode.
2. Press the Up/Down button to select one of the Video mode options – Resolution, Stabilization or Motion Detect.
3. Press the Right/Left button to select the setting that appears on the right hand side of the menu table.
4. Press the OK/Menu button again to confirm and save your choice.

5. Press the Exit button.
6. Your camera is now ready to capture videos with the new settings you selected.

Resolution



1. Press the Down button to enter the Resolution submenu.
2. Use the Right/Left button to move between the 5 video resolution settings – HD(1080p) / HD(720p) / WVGA 60 / VGA / QVGA.
3. Press the OK/Menu button to confirm and save your choice.

4. Press the Exit button.
5. Your camera is now ready to capture videos with the new settings you selected.
6. The selected resolution icon appears on the top right corner of the LCD.

Stabilization



1. Press the Down button to enter the Stabilization submenu
2. Use the Right/Left button to select either "On" or "Off".
3. Press the OK/Menu button to confirm and save your choice.

4. Press the Exit button.
5. Your camera is now ready to capture videos with the new settings you selected.
6. If “On” is selected the  icon will appear on the right hand side of the LCD.

Note: Stabilization is not supported in HD(1080p) and WVGA/60fps resolutions.

Motion Detect

Using this feature the camcorder will start to record videos automatically if it detects movement. The recording will also stop automatically if no movement is detected.



1. Press the Down button to enter the Motion Detect submenu.
2. Use the Right/Left button to select either “On” or “Off”.
3. Press the OK/Menu button to confirm and save your choice.
4. Press the Exit button.
5. Your camera is now ready to capture videos with the new settings you selected.

Note: If “On” is selected, the Motion Detect icon  will appear on the left side of the LCD and the camcorder will start to record videos automatically if it detects a movement. The recording will also stop automatically if no movement is detected.



Capturing Pictures

You can use your camera to capture still pictures.



1. Aim the camera at the object you wish to photograph.
2. Use the optical zoom button on the top of the camera to Tele/Wide to zoom in or out of the object.
3. The zoom can be set as 1X~10X (5X Optical + 2X Digital) or 1X~20X (5X Optical + 4X Digital)
4. For close-up pictures of objects located within 80cm use the Macro mode feature as explained in the Effects Submenu mode.
5. Press the Picture Shutter button half way down to focus in on your subject.
6. A white focusing frame appears in the center of the LCD.
7. Once you have the object you wish to photo in this white frame, press the Picture Shutter button fully down for a green focusing frame to appear before the picture is taken.
8. The camera will beep and the picture taken is now saved to the memory.
9. The recorded photo file will be saved in JPEG format.
10. The number of photos that can be taken for each resolution and per the memory card inserted appears on the top left of the LCD screen.
11. After the shot is taken the number is reduced by one.
12. To view and/or delete the photo you have taken press the Playback button.

Note:

When the camcorder's internal memory is full, "MEMORY FULL" appears on the LCD screen when you attempt to press the Shutter button to take a photo. Download these photos to your PC or delete them in order to take more photos. Alternatively, you can insert an SD memory card to expand the memory and take many more photos before having to download them to the PC.

The number of photos that can be captured not only depends on the SD card's capacity but also on the resolution selected. Better quality photos are taken at higher resolutions but these will also take up more memory on the card.

In Picture mode there are three photo resolutions for you to choose from before capturing your pictures. The higher the resolution selected the better the quality of the photo, however higher quality photos use up more memory.

Image Quality	
	High Quality: 8 Mega Pixels
	Standard Quality: 5 Mega Pixels
	Low Quality: 3 Mega Pixels

To enter the setup submenu options for the Picture mode press the OK/Menu button.



1. Press the Right/Left buttons to select the Picture mode.
2. Press the Up/Down button to select one of the Picture mode options – Resolution, Flash or Selftimer.
3. Press the Right/Left button to select the setting that appears on the right hand side of the menu table.
4. Press the OK/Menu button again to confirm and save your choice.

5. Press the Exit button.
6. Your camera is now ready to snap pictures with the new settings you selected.

Resolution

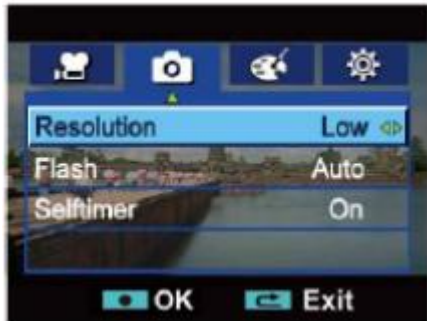

1. Press the Down button to enter the Resolution submenu.
2. Use the Right/Left button to move between the 3 picture resolution settings – High / Std / Low.
3. Press the OK/Menu button to confirm and save your choice.

4. Press the Exit button.
5. Your camera is now ready to capture photos with the new settings you selected.
6. The selected resolution icon appears on the top left corner of the LCD.

Flash

The camcorder has 3 flash settings. You can change the flash setting by using the Right button on the camera dial or from within the Flash submenu.

The flash icons appear at the top center of the LCD.



Auto – The flash is fired on automatically according to the light conditions at the time of taking the picture.



Red Eye – A pre flash will fire before the regular flash to reduce the red-eye affect.



Off – The flash will not fire under any circumstances. Use this mode where taking photos in a place where flash photography is prohibited or where the object is distant beyond the range of the flash.





1. Press the Down button to enter the Flash submenu.
2. Use the Right/Left button to move between the 3 picture resolution settings – Auto / Red Eye / Off.
3. Press the OK/Menu button to confirm and save your choice.
4. Press the Exit button.
5. Your camera is now ready to capture photos with the new settings you selected.

Note: The Flash will not activate if the batteries are low  or if the camera is being charged.

Selftimer

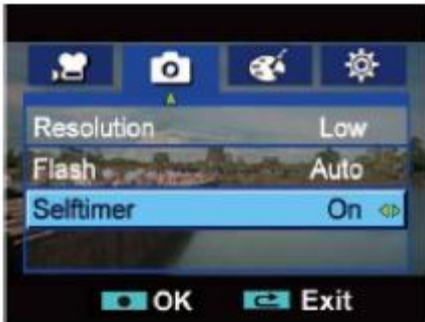
You can set the Selftimer to up the camera and include yourself in the picture. Place the camera on a tripod or on a steady and flat surface. After pressing the Picture Shutter button the photo will be taken 10 seconds later.



1. Press the Down button to enter the Selftimer submenu.
2. Use the Right/Left button to select either “On” or “Off”.
3. Press the OK/Menu button to confirm and save your choice.
4. Press the Exit button.
5. Your camera is now ready to capture photos with the new settings you selected.
6. If “On” is selected, the Selftimer icon  will appear in the center of the LCD.
7. Press the Picture Shutter button to activate the 10 second countdown.
8. The Selftimer LED at the front of the camera will blink until the picture is taken.

Effects

The Effects submenu contains 4 different options – Macro, Scene, Exposure and White Balance.

To enter the setup submenu options for the Effects mode press the OK/Menu button.



1. Press the Right/Left buttons to select the Effects mode.
2. Press the Up/Down button to select one of the Effects mode options – Macro, Scene, Exposure and White Balance.
3. Press the Right/Left button to select the setting that appears on the right hand side of the menu table.
4. Press the OK/Menu button again to confirm and save your choice.

Macro

The camcorder has a close-up picture mode to allow you to take pictures at close range within 80cm.



1. Press the Down button to enter the Macro Mode submenu.
2. Use the Right/Left button to move between “Macro” or “Normal”.
3. Press the OK/Menu button to confirm and save your choice.
4. Press the Exit button.

5. Your camera is now ready to capture photos with the new settings you selected.
6. If “Macro” is selected, a Macro icon  will appear on the bottom left of the LCD.
7. To revert to Normal mode select “Normal” in step 2.



Scene

The camcorder has a selection of built-in scenes. Select the scene that you want before taking the photo.

- **Auto:** Shoot without any special effect on the image.
- **Skin:** Shoot with an effect that makea skin tones more natural
- **Night:** Use Night mode for night scenes or low light conditions.
- **Backlight:** You can take shots when bright light is behind the subject.
- **B/W:** The image is converted to black-and-white.
- **Classic:** The image is converted to sepia look.
- **Negative:** The image is converted as the negative of the normal



1. Press the Down button to enter the Scene submenu.
2. Use the Right/Left button to move between the 7 options – Auto / Skin / Night / Backlight / Black and White / Classic / Negative.
3. Press the OK/Menu button to confirm and save your choice.
4. Press the Exit button.
5. Your camera is now ready to capture photos with the new settings you selected.
6. The following options appear as icons on the bottom left corner of the LCD

when selected – Skin  , Night  and Backlight 

Exposure

The camcorder adjusts image exposure automatically. In certain circumstances you may wish to adjust the exposure compensation manually.



1. Press the Down button to enter the Exposure sub-menu.
2. Use the Right/Left button to move between the 7 options – -1.0 EV / -0.6 EV / -

0.3 EV / Auto / 0.3 EV / 0.6 EV / 1.0 EV.

3. Press the OK/Menu button to confirm and save your choice.
4. Press the Exit button.
5. Your camera is now ready to capture photos with the new settings you selected.
6. The EV option selected appears next to the icon  on the bottom of the LCD.

White Balance

The camcorder adjusts the color balance of images automatically.



1. Press the Down button to enter the White Balance (WB) submenu.
2. Use the Right/Left button to move between the 4 options – Auto / Daylight / Fluorescent / Tungsten.
3. The option selected is immediately previewed on the LCD.
4. Press the OK/Menu button to confirm and save your choice.
5. Press the Exit button.
6. Your camera is now ready to capture photos with the new settings you selected.
7. If one of the White Balance option is selected the icon **WB** appears on the bottom of the LCD.

Settings

Your camcorder has 7 setting options – Sound (operation sound), Information, Time Setting, Format, TV, Language and Default Setting.



To enter the setup submenu options for the Setting mode press the OK/Menu button.

1. Press the Right/Left buttons to select the Setting mode.
2. Press the Up/Down button to select one of the Setting mode options – Sound,

Information, Time Setting, Format, TV, Language and Default Setting.

3. Press the Right/Left button to select the setting that appears on the right hand side of the menu table.
4. Press the OK/Menu button again to confirm and save your choice.
5. Press the Exit button.
6. Your camera is now ready with the new settings you selected.

Sound



1. Press the Down button to enter the Sound submenu.
2. Use the Right/Left button to select “On” or “Off”.
3. Press the OK/Menu button to confirm and save your choice.
4. Press the Exit button.
5. If you selected “On” the camera will emit a sound whenever a button is selected.

Information

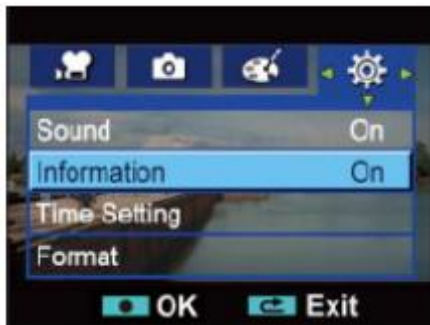

1. Press the Down button to enter the Information submenu.
2. Use the Right/Left button to select “On” or “Off”.
3. Press the OK/Menu button to confirm and save your choice.
4. Press the Exit button.
5. If you selected “On” the screen information will appear on the LCD. Selecting “Off” hides all the information on the LCD.

Note: The Up button is a hot key that enables you to show or hide the information that appears on the LCD screen.

Time Setting

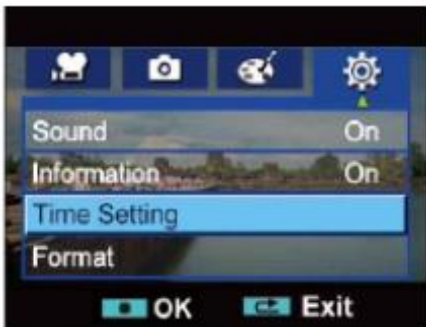

1. Press the Down button to enter the Time Setting submenu.
2. An adjustable Time Setting menu appears.



3. Use the Up/Down button to select – Year, Month, Day, Hour and Minute option.
4. Use the Right/Left button to adjust the time setting for each option.
5. Press the OK/Menu button to confirm and save your choice.
6. Press the Exit button.

Format

Please use this feature with caution. Using this feature will format either the internal built-in memory or the SD card if one is inserted in the camera. Once formatted all the media in the camera`s memory will be erased. This process is irreversible.

Important: Before formatting download all images to the computer.

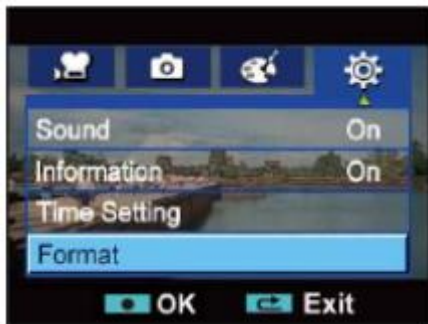

1. Press the Down button to enter the Format submenu.
2. A Format message will appear on the LCD with a “Yes” or “No”.



3. Use the Right/Left button to select the option you wish – “Yes” to continue with the format; “No” to cancel the format and revert back to the operational mode.
4. Press the OK/Menu button to confirm and save your choice.
5. If you selected to format the camera then once formatted the camera reverts to the operational mode.

TV

Select the appropriate TV standard for the area in which you are located.

The choices are NTSC or PAL. Using the wrong TV system will result in the image flickering on playback.

NTSC standard: USA, Canada, Japan, South Korea and Taiwan etc.

PAL standard: UK, Europe, China, Australia, Singapore and Hong Kong etc.

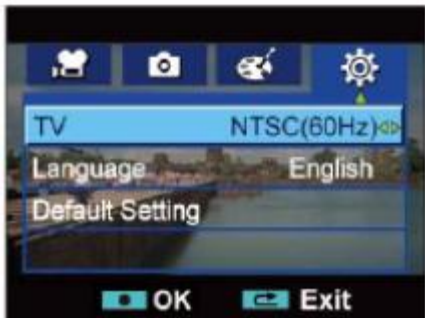

1. Press the Down button to enter the TV submenu.
2. Use the Right/Left button to select – NTSC (60Hz) or PAL (50Hz).
3. Press the OK/Menu button to confirm and save your choice.
4. Press the Exit button.

Language

Select the language of your choice. There are 10 languages from which to choose. Once the language is selected all the camera`s menus and information will appear in that language.



1. Press the Down button to enter the Language submenu.
2. Use the Right/Left button to select the language of your choice – English, German, French, Italian, Spanish, Portuguese, Chinese Traditional, Chinese Simplified, Japanese and Korean.
3. Press the OK/Menu button to confirm and save your choice.
4. Press the Exit button.

Default Setting

Use this option to revert to the original factory setting.



1. Press the Down button to enter the Default Setting submenu.
2. A Default Setting message will appear on the LCD with a “Yes” or “No”.





3. Use the Right/Left button to select the option you wish – “Yes” to revert back to the original factory setting; “No” to cancel the request and revert back to the operational mode.
4. Press the OK/Menu button to confirm and save your choice.

The following table indicates the Camera's default setting

Setting	Default Factory Setting
Resolution	HD (1080p) for Movie Standard for Picture
Flash	Off
Self timer	Off
Scene	Auto
Exposure	0EV
WB (White Balance)	Auto
Sound	On
Information	On
TV	Depends on shipping area
Language	Depends on shipping area
Volume	Level 12
Macro	Normal
Stabilization	Off
Motion Detection	Off

Camera Playback Modes

The Buttons have the following functions in Movie and Picture Playback Modes.

	<p>Direction Button</p> <p>Right Button: Go to the next movie/picture. Fast forward</p> <p>Left Button: Go to the previous movie/picture. Fast rewind</p> <p>Up Button: Volume increase/Information ON/OFF</p> <p>Down Button: Volume decrease</p> <p>Menu/OK Button: Enter to movie or picture option Menu / Validate setting.</p> <p>Tele Button : Zoom in.</p> <p>Wide Button : Zoom out</p>
	<p>RECORD/PLAY Button functions:</p> <ol style="list-style-type: none">1. Switch between Record and Playback modes.2. Return to the previous page.
	<p>Movie Shutter Button:</p> <p>Start playing the recorded movie.</p>

The Playback mode is for viewing and managing the photos and videos on the built-in memory or the SD card inserted in the camera.



1. Press the Playback button beneath the dial for the Playback menu screen to appear.
2. Use the Right/Left button to select the desired Playback mode - Movie or Picture.
3. Press the OK/Menu button to enter that modes thumbnail preview folder.
4. If there are no images in the mode a NO FILE message will appear on the LCD.

5. Use the Right/Left button to select the desired video or photo you want to view.
6. Press the OK/Menu button to view the selected video or photo.

Movie Playback

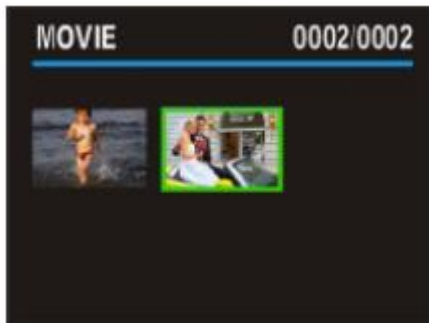

1. In the Movie Playback thumbnail view select the movie you wish to view using the Right/Left button.
2. Press the OK/Menu button for the first frame of the selected video to appear on the LCD.

3. The sequence number of the video, the duration of the video and the resolution at which the video was recorded appears above the video on the top of the LCD.



4. Press the Movie Shutter button to start playing the video.
5. Press the Up/Down button to adjust the volume. The volume icon  will appear on the left side of the LCD.
6. Press the Right/Left button to fast forward or rewind the video while it is playing.
7. Press the Movie Shutter button to pause the video. The Pause/Play icon



will appear on the LCD.

8. Press the Movie Shutter again to continue playing.

Movie Playback Mode Menu

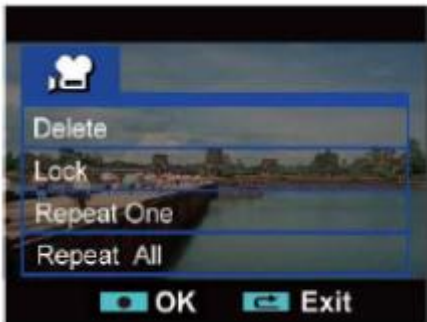

1. In the Movie Playback mode press the OK/Menu button.
2. The Movie Playback options appear.

3. Press the Up/Down button to select one of the options – Delete, Lock, Repeat One or Repeat All.

Delete Movies

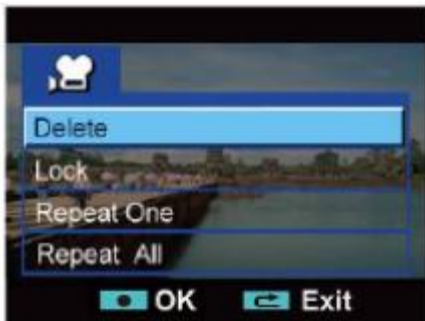

1. Press the Down button to enter the Delete submenu.
2. Select the Up button to delete all the videos; the Down button to delete the present video or the Exit button to Exit the mode.



Delete All

1. On selecting the Up button, a Delete All message will appear on the LCD.



2. Use the Right/Left button to select either “Yes” or “No”.
3. Press the OK/Menu button to confirm and save your choice.
4. If you selected “Yes” all the videos in the Movie mode will be deleted.

Delete One

1. On selecting the Down button, a Delete One message will appear on the LCD.
2. Use the Right/Left button to select either “Yes” or “No”.
3. Press the OK/Menu button to confirm and save your choice.
4. If you selected “Yes” the selected video in the Movie mode will be deleted.

Note: Only unlocked videos will be deleted.

If an SD card is inserted you will be deleting the videos stored on the card.

To delete Locked videos you will first need to unlock them.

Lock Movies

In order to prevent movies being deleted by accident you can lock either all or single movies.



1. Press the Down button to enter the Lock submenu.
2. Select the Up button to lock all the videos; the Down button to lock the present video or the Exit button to Exit the mode.



3. A Lock icon  will appear on the top of the LCD to show if the video is locked or not.
4. To unlock the video simply press the same button as before in Step 2 when you locked the video.
5. The Lock icon will disappear.

Repeat Movies

Use this function to repeat playing either single movies or all the movies in the order they appear in the memory.

Repeat One

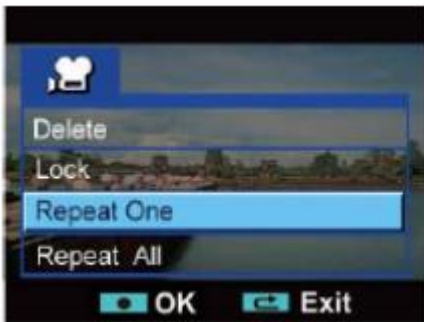

1. Press the Down button to enter the Repeat One submenu.
2. Press the OK/Menu button for the selected movies to start playing.
3. The same movie will repeat itself over and over.

4. Press the Movie Shutter to Pause/Play
5. Press the Exit button to stop the repeat.

Repeat All



1. Press the Down button to enter the Repeat All submenu.
2. Press the OK/Menu button for all the movies to start playing one after the other.
3. Press the Movie Shutter to Pause/Play
4. Press the Exit button to stop the repeat.

Picture Playback



1. Use the Right/Left button to select the photo to view in the Picture thumbnail preview window
2. Press the OK/Menu button to view the picture in full screen.
3. Use the Right/Left button to go to the next or previous picture.
4. To magnify the picture on the LCD, use the W/T zoom button
5. To navigate around the magnified photo use the Up/Down/Left/Right

buttons.

6. Press the OK/Menu button to exit the magnify mode.

Picture Playback Mode Menu

1. In the Picture Playback mode select a photo.
2. Press the OK/Menu button the Picture Playback menu to appear.



Delete

1. Press the Down button to select the Delete submenu



2. Press the OK/Menu button to open the Delete Picture menu.
3. Press the Right/Left button to select the Picture you wish to delete.



4. Press the Up button to delete all the pictures; The Down button to delete the selected picture only; Exit button to exit without deleting.

Delete All

1. If you selected Delete All a confirmation message screen will appear on the LCD.



2. Use the Right/Left button to choose “Yes” or “No”
3. If you choose “Yes” all the unlocked pictures in the camera’s memory or the SD card if inserted will be deleted. This process is irreversible.
4. Pressing “No” will cancel the delete process
5. Press the OK/Menu button to confirm and save your choice.

Delete One

1. Press the Down button to delete the presently selected photo.

2. A Delete One confirmation message screen will appear.
3. Use the Right/Left button to select “Yes” or “No”.
4. If you choose “Yes” the present picture if unlocked will be deleted from the camera`s memory or the SD card if inserted. This process is irreversible.
5. Pressing “No” will cancel the delete process.
6. Press the OK/Menu button to confirm and save your choice.

Lock Pictures

This function can prevent a single or all pictures from being deleted accidentally.



1. Use the Down button to select the Lock submenu.
2. Press the OK/Menu button to open the Lock menu screen



3. Use the Right/Left button to select the picture.
4. Use the Up button to lock/unlock all the pictures.
5. Use the Down button to lock/unlock the presently selected picture.
6. Press the Playback button to Exit.

Make Slideshow

This function automatically plays all the pictures in consecutive order.



1. Press the Down button to select the Slideshow submenu.
2. Press the OK/Menu button to start the slideshow.
3. Press the OK/Menu button again to stop the slideshow and return to the Picture Playback mode menu.

Connecting to a High Definition TV to view images

1. Connect one end of the HDMI cable to your Camera's HDMI Out port.
2. Connect the other end of the cable to a television.
3. Set video input source of a TV to " HDMI" option.
4. The steps for viewing stored pictures and movie on a TV are exactly the same as for viewing them on the LCD monitor.

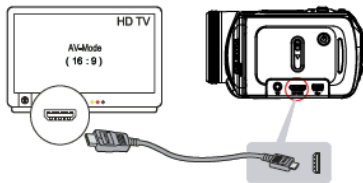

Note: The camera will not be able to capture movies or snap pictures when it is connected to an HDTV.

The LCD will also not display any image when connected to an HDTV.

Connecting to a non High Definition TV to view images

1. Connect one end of the AV cable to your Camera's AV Out port.
2. Connect the other end of the cable to a television.
3. The steps for viewing stored pictures and movie on a TV are exactly the same as for viewing them on the LCD monitor.

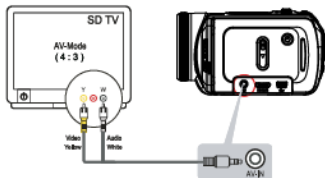

Note: No image will appear on the LCD screen when the camera is connected to the TV.

Transferring Images to your PC using the software

Once you have taken photos and videos with your camera you now need to download or transfer them to your computer. This allows you to save all your photos and videos for playing, editing, emailing or uploading as you desire.

Once your photos and videos are transferred to the PC you may delete them from your camera thereby freeing up the camera's memory to take more memorable shots.

Use the “Snap ‘n Share Pro” program to import the videos from your camera.

1. Plug one end of the provided USB cable into the USB slot on your camera.
2. Plug the other end of the USB cable into a USB port on your computer.
3. Turn you camera on.
4. Be sure to wait until the camera is recognized by your computer.

Important: We recommend not opening the software until you see the “Your new hardware is installed and ready to use” pop-up box on the taskbar. The camera may not function properly if you do not see this message before you open your application.



1. Double-click the “Snap ‘n Share Pro” icon that appears on your desktop to launch the “Snap ‘n Share Pro” program.



2. The “**Welcome to Snap ‘n Share Pro**” Product Registration screen will open. This screen will appear each time you open the application until you register. To register your product please click the “Register Online” button and fill out the online registration form (This requires an internet connection).

Important:

1. In order to complete the installation process you are required to register. Registering your product entitles you to discounts on upgrades as well as Free Customer Support.
2. You will not be requested to enter information other than your name, email and address.

Once you have registered successfully you will be able to open and use the Snap ‘n Share Pro application.

If you choose to register at a later time click the “**Continue**” button.



Snap 'n' Share pro

Copyright © 2008 Sakar International, Inc.

Copyright © 2006-2008 Smith Micro Software, Inc. All Rights reserved

Welcome To Snap 'n Share pro

In order to complete the installation process, you are required to register.

Registering your product entitles you to discounts on upgrades as well as free Customer support.

[Register Online](#)

Remind Me:

[Continue](#)

3. The “Snap ‘n Share Pro” Main Menu screen appears.



4. Click on the “**Get Media**” button to open the Get Media Wizard to begin transferring the photos and videos captured with your camera to the computer.



5. Step 1 - Select the device (drive) where media is stored on your camera from the Active Devices window.

Select the “**Custom**” copy method option to preview and choose the photos and videos you wish to download from the camera to your PC.

Note: Selecting the “**Express**” copy option will automatically download all media from the selected device drive to the computer without the option of selecting the media items.

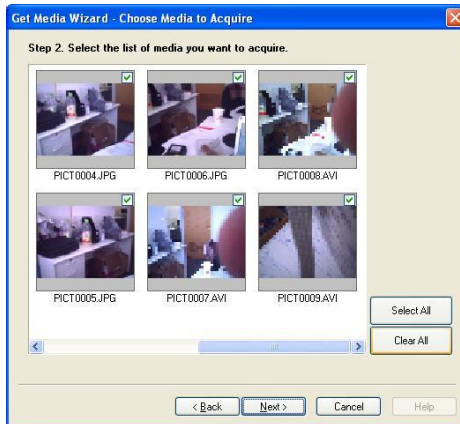

6. Step 2 - Select the media items you wish to download and click the “Next” button.

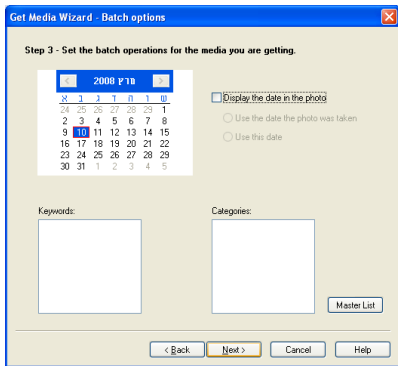

7. Step 3 - If you have photos you can choose to batch these photos once they download. Add active captions to the picture - add a date, keywords and categories. Click the “Next” button to continue.



8. Step 4 - Choose where to place your media once it is downloaded to the computer.
- You can also choose the website where you would like to upload your media.
 - You can also select to “Delete the media from the camera after the files have been transferred”. This will automatically delete the images on your camera and free up memory to continue capturing photos and videos.

- On clicking the “**Finish**” button your media will begin to download from the camera to the selected location.

Note: If you also selected a website, once the media is downloaded it can be viewed in the ‘Select Photos’ mode of your application and the application will jump to the ‘Upload’ mode and open the web browser of the site you chose.

For more information please refer to the Quick Start Help Guide or Show Me How Tour tutorial from within the “Snap ‘n Share Pro” application.

Manually transfer media to your Digital Camera

Your camera is a Mass Storage device

1. Connect your DV camera to your computer using the USB cable.
2. “**MSDC**” will appear on the LCD, indicating that your DV camera is in Mass Storage Mode.
3. Double click the My Computer icon on your desktop. Click the Removable Disk that appears. Open the DCIM folder.

4. You can import media from your computer directly to this folder to use it as a removable Disk.

Note: After you connect your DV to your PC, the DV will be automatically turned on. The camera will remain on all the while it is plugged into the USB and it won't be switched off. On disconnecting the USB cable the camera will automatically switch off.

Everything you need to get the most of your media and MORE

The “Snap ‘n Share Pro” software that is now installed on your computer allows you to edit existing photos that you have on your computer as well as playing, emailing and uploading the videos that you have captured with your camera.

Note: In order to play the videos Window Media Player needs to be the default player on your computer.

Click the “Snap ‘n Share Pro” icon that appears on your desktop to open the “Snap ‘n Share Pro” Software.



From the Main Menu screen that appears, select the **“Select Photos”**, **“Enhance Photos”** or **“Captions & Sounds”** buttons. You can use these features to edit your photos:

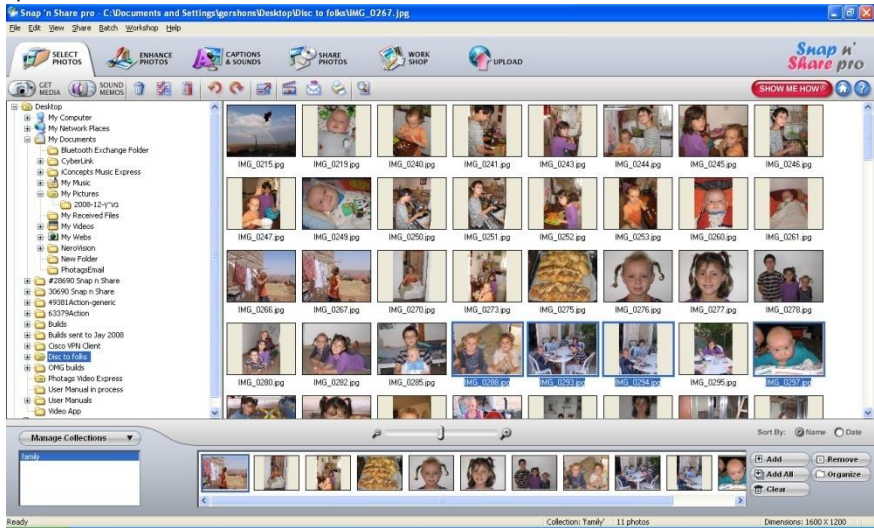

- **Manage your photos** by creating countless unique photo collections without duplicating any photos. Simply select the photos from the Thumbnail window and add them to the collection window at the bottom of the screen. Click the 'Add' button or drag the photo into the window.
- **Play your videos** – double click on the video that appears in the thumbnail screen in the Select Photos mode, or right click on the video and select the 'Play' option from the menu that appears.
- **Burn CD's** of any folders for backup and storage by right clicking on the folder in the Directory tree and choose the 'Burn to CD' option. To burn a CD of your collection, select the collection you wish to burn and then open the Manage Collections drop down menu and choose the Burn to CD option.
- **Enhance your photos** - Auto Enhance, Crop, Correct Red Eye, Manually Adjust and add Special Effects.
- **Add Active Captions and Sounds** - Add Text Captions, Audio, Frames, Shapes, Keywords, Clipart... and more to your photo that can be viewed or hidden any time.
- **Locate and Organize your photos and collections** - Search by Captions, Category, Keyword or Date directly from the operating system of your computer.

- **SlideShow** – View all the photos in your collection and add background music to your slideshow
- **Share your photos** via E-mail, Local Printing and Create HTML web pages for uploading online.
- **Workshop features** - Create Photo Albums, Frames, Calendars, two-sided Greeting Cards and Postcards to email or print on standard photo paper.
- **Upload Photos & Videos** – Choose one of the websites to upload photos and videos to your account profile in myspace, flickr, facebook or YouTube.



For more detailed information of how to use all these features please refer to the Quick Start Help Guide and/or the Show Me How Tour tutorial from within the “Snap ‘n Share Pro” application.

Video Express application

The Snap 'n Share Pro software installs a custom built Video Express application.

This application is a convenient and powerful tool for creating your very own professional looking movies.

Create movies on whatever theme you wish. Using all the media that you have on your computer as well as the videos that you capture with your camera you can edit, save, upload and burn your movies to CD or DVD to share with family and friends.

The movie is saved in highly compressed wmv format with excellent picture quality.

To open the Video Express:

1. Click the '**Create Videos**' icon from the Snap 'n Share Pro Main Menu to launch the "Video Express" application, or



2. Double click the “**Video Express**” icon that appears on your desktop to launch and open the “Video Express” application.



The following is a basic overview of the steps involved in making a movie.

1. **Create a Project (Manage mode)**

- A movie project is a movie that is still open for editing and revising.
- All of the source files and elements that make up your movie (videos, pictures, audio files) are arranged in a desired sequence with effects and transitions to create your very own movie.
- It is possible to create several unfinished projects at one time.
- Opening a new project in the ‘**Manage**’ mode is the first step in creating your movie.

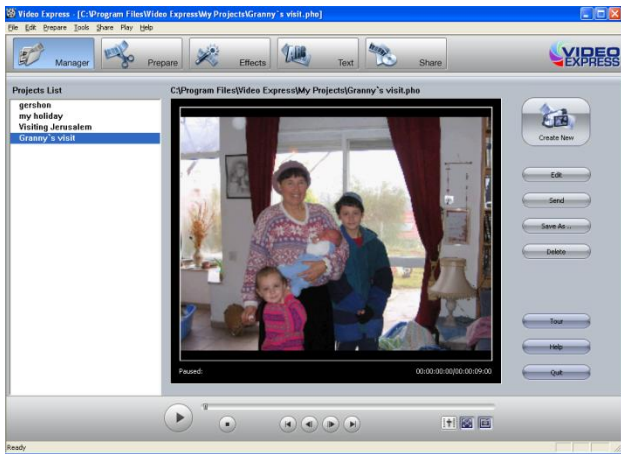

2. **You are now ready you create your own movie by using the 'Prepare', 'Effects' and 'Text' mode features.**
3. **Find Media and Create Collections**

- The “**Prepare**” mode is the next step in creating a movie. Find the media files on your PC or camera that you would like to use in your movie project.
- A movie is made up of video and photo files that are placed sequentially with accompanying audio and special effects.
- Media on your PC can either be inserted directly from the “**Folder**” (directory tree) of your computer into your movie project or placed in a "Collection".
- “Collections” are unique compilations of video, picture and audio files that are saved on your PC that you think you might want to use in your movie project.
- Putting a file in a "**Collection**" does not add the file to the movie project or obligate you to do so. It is just a convenient container for files that you think you might want to use at a later point.
- At any stage of the movie creation you can preview the movie by using the **Video Player controls**



4. Adding Media to your Movie Project

- The next step is to actually add the media files to your movie project and begin shaping your movie.

- Click the “**Open Media**” button to import media from your Computer to the Video Express
- Click on the “**Get Media**” button to download videos from the camera inserted.
- Any file that you want to include in your movie is dragged or added to the ‘**Timeline/Storyboard**’ window.
- This ‘Timeline/Storyboard’ window displays the files in chronological order.
- Files that have been placed in the ‘Timeline/Storyboard’ can be easily moved, arranged and added to or removed.
- Use the “**Effects**” mode to add various special effects and transitions between files can also be inserted to give your movie a smooth, professional look and feel.



- You can add 'Text' either as Titles or Credits to the beginning or end of your movie or as overlay text that will appear anywhere you wish on the selected clip.



5. Creating and Saving a Completed Movie File

- When all of the arranging and editing is finished in the Timeline/Storyboard and your movie project is complete, you are ready to create a completed movie file.

- Completed movie files will be saved to your PC as a .WMV file
- The application gives you the choice of how to share your movie
- The completed movie once saved to your computer can be shared via email, uploaded to the web, copied to a CD or burn to a DVD.



Congratulations!! You have created you very own movie using Video Express.

For more detailed information of how to use all these features please refer to the Quick Start Help Guide and/or the Show Me How Tour tutorial from within the “Video Express” application.

Technical Support

For all installation and software related technical support you can email your enquiries to cs@smithmicro.com.

For all hardware and warranty related issue with the camera see the next section.

Your DV camera is a delicate instrument- please handle it with care.

Sakar Warranty Card

This warranty covers for the original consumer purchaser only and is not transferable. Products that fail to function properly UNDER NORMAL USAGE, due to defects in material or workmanship. Your product will be repaired at no charge for parts or labor for a period of one year.

What Is Not Covered By Warranty:

Damages or malfunctions not resulting from defects in material or workmanship and damages or malfunctions from other than normal use, including but limited to, repair by unauthorized parties, tampering, modification or accident.

What To Do When Service Is Required:

When returning your defective product (postage pre-paid) for service, your package should include:

1. Copy of **original** bill of sale
2. A detailed written description of the problem.
3. Your return address and telephone number (Daytime)

MAIL TO ADDRESS BELOW:

Sakar International
Attention: Service Department
195 Carter Drive
Edison, NJ 08817

For technical support issues please visit our website at www.sakarhelp.com.

You can find manuals, software, drivers, and FAQ's at the website.

Can't find what you are looking for? Fill out an online ticket and one of our technical support team members will answer your questions or call our tech support department toll free at (877) 397-8200

Technical Specifications

Image Sensor	5 Mega Pixel CMOS Sensor
Image Resolution	High 3200x2400 (8M Pixels) Std 2592x1944 (5M Pixels) Low 2048x1536 (3M Pixels)
Video Resolution	HD(1080p) 1440X1080(30fps) HD(720p) 1280X720(30fps) WVGA 848X480(60fps) VGA 640X480(30fps) QVGA 320X240(30fps)
LCD Display	3" TFT(4:3)
LCD Swivel	90°
Internal Memory	Built-in 128MB Memory (partial memory is used for Firmware code)
External Memory	SD card up to 8 GB
Lens	Lens f=6.8 ~ 34mm; F3.5 ~3.7
Optical Zoom	Zoom HD (1080p):1X~10X (5X Optical + 2X Digital) . Other video resolution:1X~20X (5X Optical + 4X Digital)
Self-timer	10s
File Format	JPEG (Still Image) /AVI (Video)
Focus Range Macro	1 ~ 80cm
Focus Range Normal	10cm ~ infinite

Microphone	YES
Speaker	YES
Recorder	YES
White Balance	Auto/Manual (Daylight, Fluorescent, Tungsten)
Exposure	Auto/Manual
Flash	Auto/Red-Eye-Reduction/Off
Image Play	Single Image/Slideshow
Interface	USB 2.0
System Requirements	Windows XP, VISTA
TV out	NTSC/PAL Selectable, HDMI
Battery	Lithium-ion Rechargeable
Working Temperature	0-40 C

Trouble Shooting

- 1. If the LCD image is not clear when shooting, how can the focus be adjusted?**

When taking photos and the object is within 80cm, use the Macro Mode which is a Submenu of the Effect Mode.

- 2. The flash is not working.**

The camera is in Macro Mode / The battery power is low.

- 3. The files on the memory card do not display smoothly when the LCD shows the “!” marking.**

The “!” means the SD card is low speed or has the wrong content inside. The way to solve this condition is to format the SD card with the camcorder instead of the PC (Please refer to the detail Format instruction section).

4. Why is Camera Flash not active when taking pictures?

Make sure that the focus range is NOT set at Macro mode, as flash is disabled in this mode. Scroll through Picture mode and set Flash as Auto; note that Flash OFF is the default pre-set mode for normal picture taking. In Auto mode camera flash fires ONLY when necessary (in dark setting as example).

5. Why do some of my indoor pictures look blurry and dark?

Camera extends pictures exposure time under low light/ indoor condition. Keep camera (and photographed subject) steady for several seconds when taking pictures. Shutter will sound when picture has been taken.

6. How do I charge the battery?

The computer will not charge the battery when connected. You must ONLY use the supplied AC charger.

Camera must be turned OFF; blinking light confirms charging, but light is constant when charging has been completed.