

POWER AVAILABILITY

# *Nfinity*<sup>™</sup> Power System

USER MANUAL



105/210V  
50/60Hz  
4 to 16 kVA



---

# TABLE OF CONTENTS

<b>IMPORTANT SAFETY INSTRUCTIONS</b> .....	<b>1</b>
<b>GLOSSARY OF SYMBOLS</b> .....	<b>2</b>
<b>1.0 INTRODUCTION</b>	
1.1 General Description .....	3
1.1.1 System Description .....	3
1.2 Modes of Operation .....	5
1.3 Major Components .....	6
1.3.1 Unit Frame .....	6
1.3.2 User Interface Module .....	6
1.3.3 System Control Module .....	6
1.3.4 Power Module .....	7
1.3.5 Battery Module .....	7
<b>2.0 INSTALLATION</b>	
2.1 Inspection .....	8
2.1.1 Environment .....	8
2.1.2 Required Setup Equipment .....	8
2.1.3 Site Preparation .....	8
2.2 Unloading .....	9
2.2.1 Unloading the UPS .....	9
2.2.2 Stationary Mounting .....	10
2.3 Cable Installation .....	11
2.3.1 Wiring Preparation .....	11
2.3.2 Connecting to External Panel Boards .....	13
Input Cabling and Protection .....	13
Output Cabling .....	14
2.3.3 REPO Connection .....	15
2.4 Communications .....	16
2.4.1 COM Ports .....	16
2.4.2 Intellislot™ Ports .....	16
<b>3.0 OPERATING INSTRUCTIONS</b>	
3.1 Controls and Indicators .....	17
3.1.1 Display Controls .....	17
3.2 Status LED Modes .....	18
3.3 Navigating the Menu .....	18
3.4 Operating Procedures .....	19
3.4.1 Start-Up and Initialization .....	19
3.4.2 Shutting Down the UPS .....	19
3.4.3 Manual Transfer to Bypass .....	19

---

3.5	Main Menu . . . . .	20
3.5.1	UPS Status Screen . . . . .	21
3.5.2	UPS Configuration Screen . . . . .	22
3.5.3	Display Date/Time . . . . .	27
3.5.4	Event Log . . . . .	28
3.5.5	Active Alarms . . . . .	28
3.5.6	Transfer to Bypass . . . . .	28
3.5.7	Module Replacement . . . . .	29
3.5.8	Service Tools for Liebert Global Services Engineers . . . . .	30
<b>4.0</b>	<b>TROUBLESHOOTING</b>	
4.1	Active Alarms . . . . .	31
4.2	Module LED Indication . . . . .	33
4.3	Module Replacement . . . . .	34
4.3.1	Removing Modules . . . . .	34
4.3.2	Adding or Replacing Modules . . . . .	35
4.3.3	Replacing the User Interface . . . . .	35
<b>5.0</b>	<b>MAINTENANCE</b>	
5.1	Maintenance . . . . .	36
5.1.1	Proper Care . . . . .	36
5.1.2	Scheduled Maintenance . . . . .	36
5.1.3	Replacing Fan Filters . . . . .	36
<b>6.0</b>	<b>SPECIFICATIONS</b>	
6.1	Product Warranty Registration . . . . .	37

## FIGURES

Figure 1	Front and back views (12 bay model shown) . . . . .	4
Figure 2	REPO switch connections . . . . .	15

## TABLES

Table 1	Nfinity weight and dimensions . . . . .	4
Table 2	Guide to LEDs . . . . .	33

---

## IMPORTANT SAFETY INSTRUCTIONS

---

### SAVE THESE INSTRUCTIONS

This manual contains important instructions that should be closely followed during installation and maintenance of this UPS unit and during the installation and replacement of Power and Battery Modules.

This product is designed for Commercial/Industrial use only. This product is not intended for use with life support and other U.S. FDA-designated “critical” devices. Maximum load must not exceed that shown on the UPS rating label.



### WARNING

Lethal voltages may be present within this unit even when it is apparently not operating. Observe all cautions and warnings in this manual. Failure to do so MAY result in serious injury or death. Never work alone.

Observe the following precautions when working with batteries:



### CAUTION

DO NOT dispose of Battery Modules in a fire because the modules may explode.

DO NOT open or mutilate batteries; released electrolyte is harmful to skin and eyes and may be toxic.

A battery can present a risk of electrical shock and high short-circuit current. The following precautions should be observed when working on batteries:

- Remove watches, rings and other metal objects.
- Use tools with insulated handles.

Lead-acid batteries contain hazardous toxic materials. Handle, transport and recycle in accordance with local regulations.

This UPS is designed for use on a properly grounded (earthed), 200/210 VAC, 50 or 60 Hz supply and is to be installed by qualified personnel.

**Electromagnetic Compatibility**—The Nfinity™ UPS complies with the limits for a Class A digital device, pursuant to Part 15 of FCC rules. These limits provide reasonable protection against harmful interference in a commercial environment. This device generates, uses and radiates radio frequency energy and, if not installed and used in accordance with the instruction manual, may cause harmful interference to radio communications. Operating this device in a residential area is likely to cause harmful interference which users must correct at their own expense.

Operate the UPS in an indoor environment only in an ambient temperature range of 32°F to +104°F (0°C to +40°C). Install it in a clean environment, free from conductive contaminants, moisture, flammable liquids, gases and corrosive substances.

Turn the UPS off and isolate the UPS before cleaning. Use only a soft cloth, never liquid or aerosol cleaners. Keep the front and rear vents free of dust accumulation that could restrict airflow.



















Never block or insert any object into the ventilation holes or other openings.

This UPS contains user replaceable modules. No attempts should be made to access the interior of any module. See **4.3 - Module Replacement**.

---

## GLOSSARY OF SYMBOLS

---

	<b>Risk of electrical shock</b>
	<b>Indicates caution followed by important instructions</b>
	<b>AC input</b>
	<b>AC output</b>
	<b>Requests the user to consult the manual</b>
	<b>Indicates the unit contains a valve-regulated lead acid battery</b>
	<b>Recycle</b>
	<b>DC voltage</b>
	<b>Equipment grounding conductor</b>
	<b>Bonded to ground</b>
	<b>AC voltage</b>
	<b>OFF</b>
	<b>ON</b>
	<b>Standby</b>
	<b>No telecommunication connection</b>
	<b>Locked position</b>
	<b>Unlocked position</b>
	<b>Contact closure signals</b>
	<b>Serial communications</b>

## 1.0 INTRODUCTION

---

### 1.1 General Description

Congratulations on your purchase of Liebert's Nfinity™ Uninterruptible Power System. As with every other Liebert product, we stand behind our quality. If you have any questions concerning this UPS, please feel free to contact your local dealer or Liebert representative or call the appropriate Technical Support number listed on the back of this manual.

To ensure proper installation and operation of this unit, please read this manual thoroughly.

For details on product warranty and registration, see **6.1 - Product Warranty Registration**.

#### 1.1.1 System Description

The Liebert Nfinity Power System is a modular UPS available in 8 & 12 bay frames. It is intended for use with workstations, servers, network, telecom and other sensitive electronic equipment. It provides continuous, high-quality AC power to your equipment, protecting it from any power disturbance due to blackouts, brownouts, surges or noise interference.

The Nfinity modular UPS was designed to provide maximum system availability to business-critical equipment. Nfinity is also an easily adaptable UPS system. By simply installing additional Power or Battery Modules, you can expand your current system capacity or extend your backup runtime.

Nfinity has a comprehensive user interface that enables configuration according to the user's preference. It also informs the user of details on the status of the UPS and keeps a log of events.

#### Features

- Up to 16 kVA of modular backup power
- Continuous power conditioning
- A user-friendly interface for custom configuration
- Continuous system monitoring
- Warning alarms and event logs
- Internal automatic & manual bypass

#### Standard Components

- Power Modules - for power conditioning
- Battery Modules - for backup power
- System Control Modules - for system monitoring and communications
- LCD Display - for comprehensive user indications and programmable controls
- Output Transformer - for isolation
- REPO Switch Connection

#### Communications

- Dry contacts
- RS-232
- Optional communications via Intellislot™ communication ports

Figure 1 Front and back views (12 bay model shown)

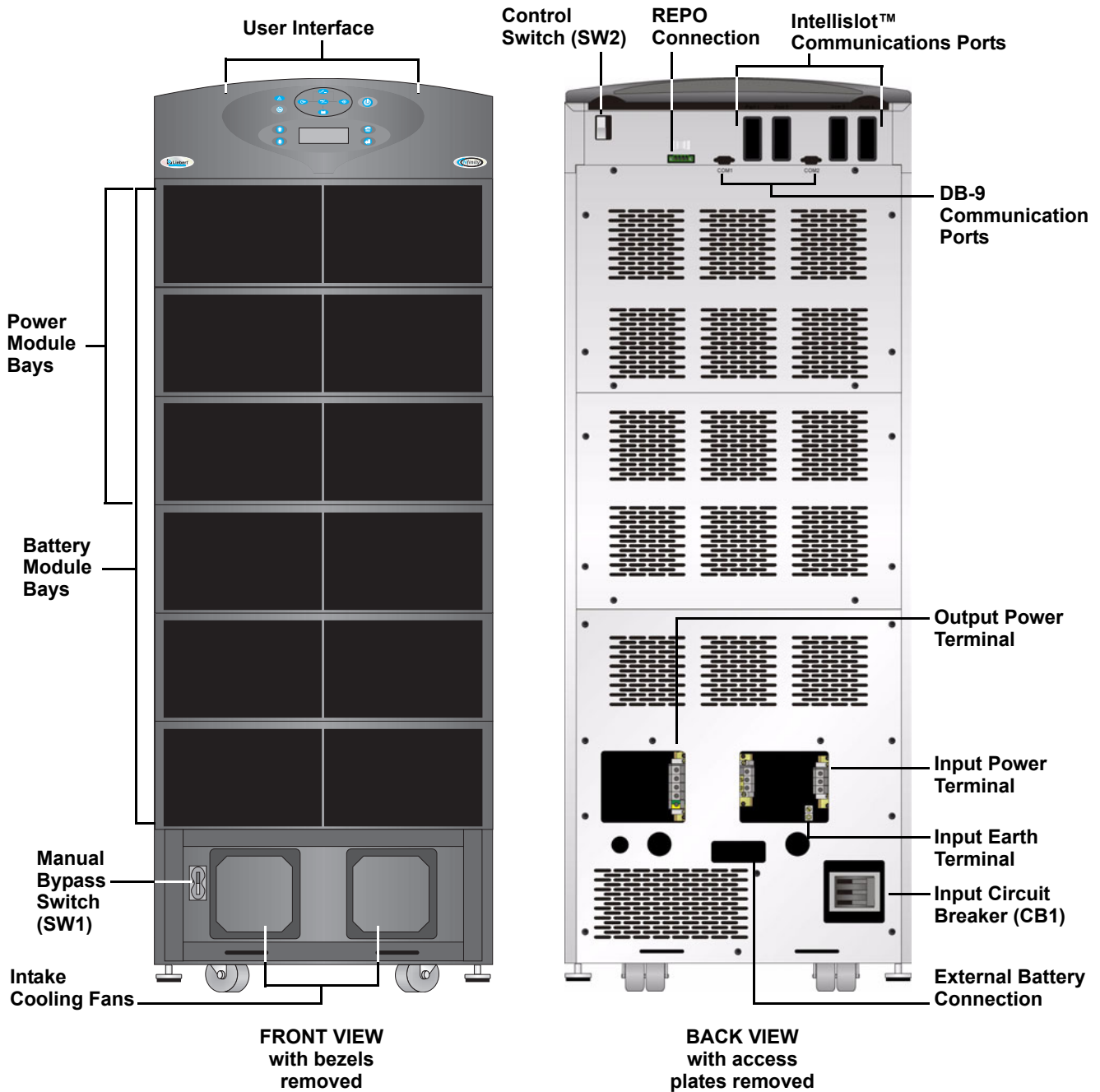

Refer to the table below for size and fully populated weight considerations.

**Table 1 Nfinity weight and dimensions**

Model	Max Weight - lb (kg)	W x D x H - in. (mm)
8 bay	855 (388)	20 x 28 x 40 (508 x 711 x 1016)
12 bay	1176 (534)	20 x 28 x 53 (508 x 711 x 1346)



## 1.2 Modes of Operation

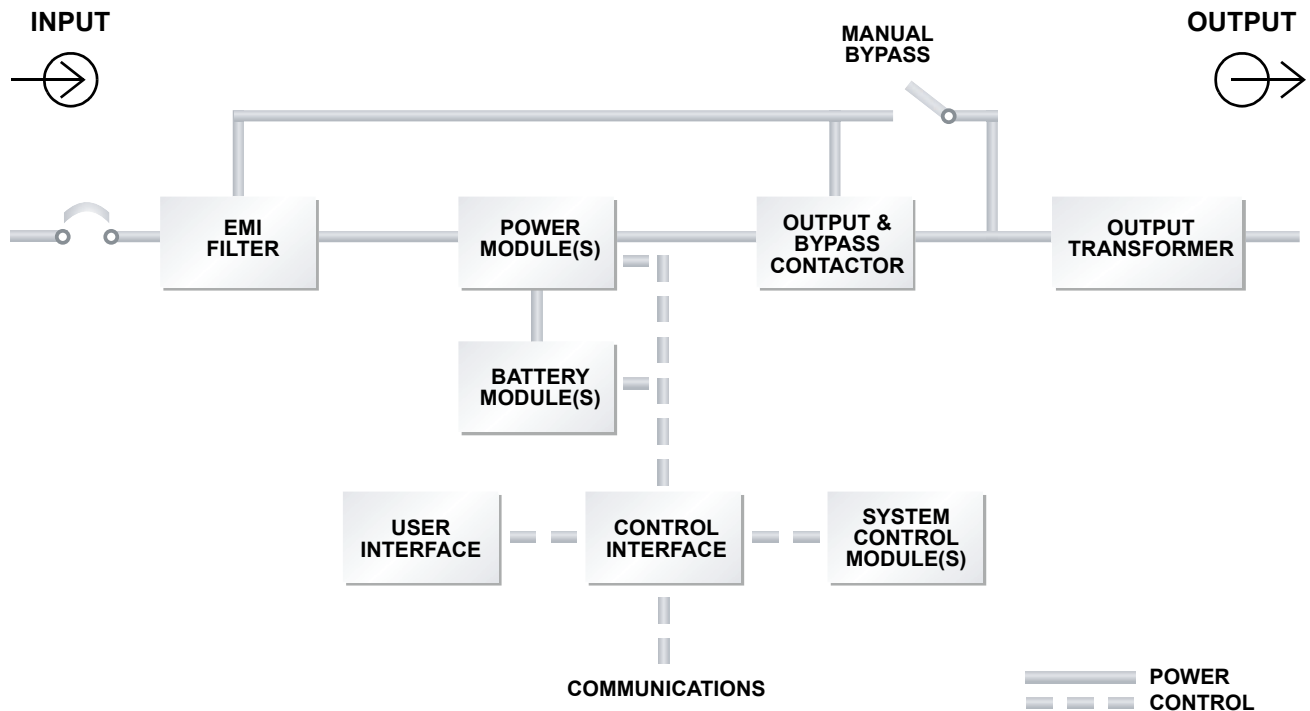

### Normal Mode

The Power Module rectifiers derive power from a utility AC source and supply regulated DC power to the inverter. The module's inverter regenerates precise AC power to supply the connected equipment. The battery charger is in the Power Module and maintains a float-charge on the batteries.

### Backup Mode

When AC utility fails, the connected equipment is supplied power by the inverter, which obtains energy from the Battery Modules. The output power equipment will not be interrupted during the failure or restoration of the AC utility source.

### Auto Restart Mode

After a power outage and complete battery discharge, and once AC utility is restored, the UPS will automatically restart and resume supplying power to connected equipment. This feature is enabled at the factory, but can be disabled by the user. The user can also program two auto restart delay settings:

1. Battery capacity level (%)
2. Countdown timer

### Bypass Mode

The bypass provides an alternate path for power to the connected equipment and operates in the following manner:

- **Automatic**

In the event of an internal fault or should the inverter overload capacity be exceeded, the UPS performs an automatic transfer of the connected equipment from the inverter to the bypass source.

- **Manual**

Should the UPS need to be taken out of service for limited maintenance or repair, manual activation of the bypass will cause an immediate transfer of the equipment from the inverter to the bypass source.

## 1.3 Major Components

The following is a general description of each component and its functions. Please review this section carefully, as it will give you a better understanding as to how the Nfinity operates.

### 1.3.1 Unit Frame

The front of the Nfinity consists of a series of plastic bezels. By grasping these bezels from the left and right sides and pulling straight out, you can remove the bezel to reveal the Battery / Power Module bays. The bottom bezel covers the internal cooling fans and the manual bypass switch.

The User Interface Module is located above the Power / Battery Module bays for easy access. By moving the User Interface and setting it on top of the frame, you will see the system control module bays.



#### NOTE

*In the figure at right, the Power Module and Battery Module are extended for illustration purposes only. Extending more than one module at a time could cause the unit to be top-heavy and/or tip.*

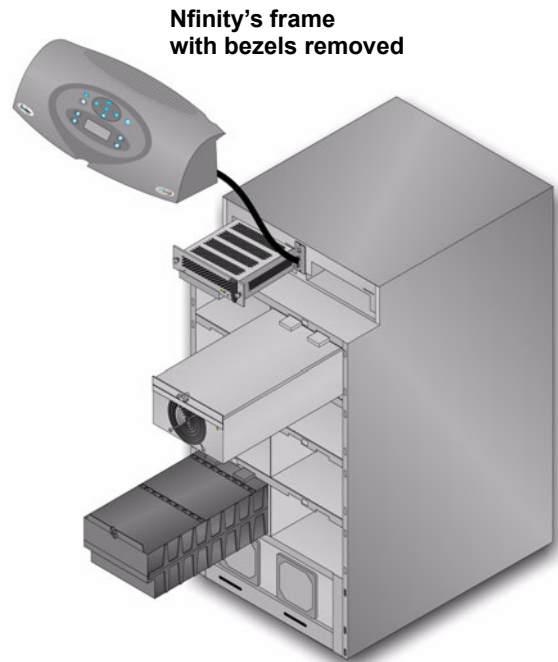

### 1.3.2 User Interface Module

The User Interface Module is the primary source of communication between the UPS and the user. From the interface, the user can:

- View the status of the UPS
- Custom configure the system
- Review the event log to assist with troubleshooting
- Enable/disable the output power
- Silence the audible alarm
- Manually transfer the unit to bypass

For a more detailed explanation on how to operate the User Interface Module, see **3.1 - Controls and Indicators**.

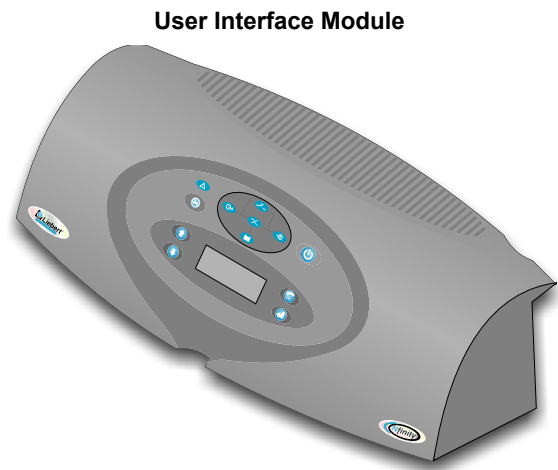

### 1.3.3 System Control Module

The System Control Module is the communications backbone of the UPS. It gathers input from all modules and processes the data to control the operation of the system — including monitoring the condition of each module. An optional redundant System Control Module can be installed to provide full system functionality (operation and communication).

Under normal operation, the Status LED (green) will blink and the Fault LED (yellow) will be off. For any condition other than this, check **4.0 - Troubleshooting**.

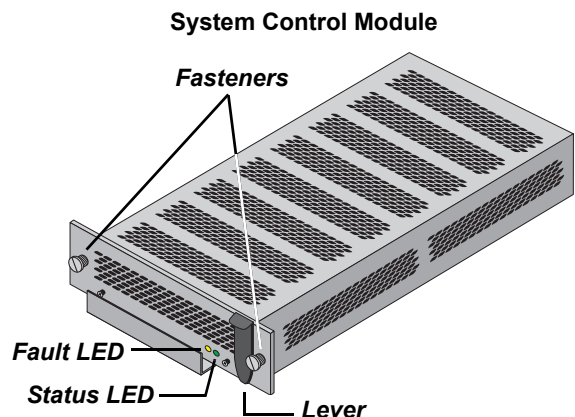

### 1.3.4 Power Module

Each power module is an independent 4 kVA, 2.8kW unit, consisting of a power factor corrected rectifier, battery charger and inverter, with associated monitoring and control circuitry. The modules are paralleled to provide greater capacity and/or redundancy. Modules may be added or replaced on-line with no interruption or danger to the connected equipment.

### 1.3.5 Battery Module

Each battery module contains 10 individual 12-volt, 9 amp hour, valve-regulated (VRLA) battery blocks with associated monitoring and controls to isolate the Battery Module in the event of a battery failure. The modules are paralleled to provide greater capacity, backup time and/or redundancy. Modules may be added or replaced on-line with no interruption or danger to the connected equipment, provided that the UPS is not operating on battery.

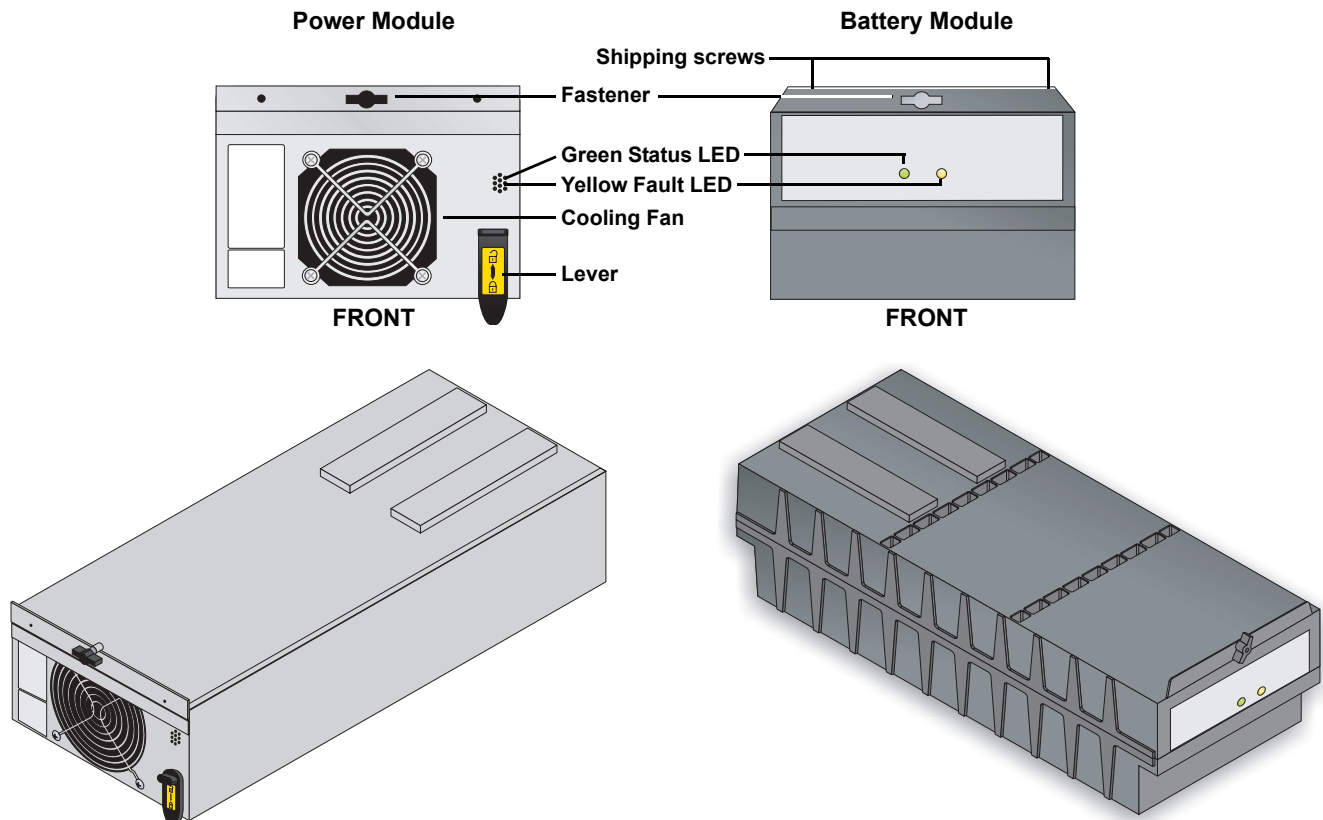

Under normal operation, the Green Status LED will blink continuously and the Yellow Fault LED will be off. For any condition other than this, check **4.0 - Troubleshooting**.



#### NOTE

*Nfinity is shipped with each battery module secured to the frame by two shipping screws. These screws should be removed prior to start-up.*

## 2.0 INSTALLATION

### 2.1 Inspection

Upon receiving the UPS, examine the packaging for any signs of mishandling or damage. If any damage is noted, call your local dealer or Liebert representative and/or notify your carrier.

#### 2.1.1 Environment



##### NOTE

*Operating in temperatures above 77°F (25°C) will reduce battery life. The UPS environment must be free of conductive contaminants and excessive moisture (water and condensation), flammable vapors, chemical fumes, corrosive gases and liquids.*

#### 2.1.2 Required Setup Equipment

The tools below are required to properly set up your UPS:

- Pallet jack
- 1/2" (13mm) ratchet or wrench
- Torque wrench (in-lb)
- Flathead screwdriver
- #2 Phillips screwdriver

#### 2.1.3 Site Preparation

When deciding where to locate your UPS, consider the weight and size of the unit. Make sure that the structural integrity of the floor can withstand the weight of a fully loaded unit.

Check to make sure that your UPS will be located in a well-ventilated area with at least 12 inches (305mm) behind it. The UPS is air-cooled utilizing internal fans. Air is drawn into the front of the UPS and is exhausted through ventilation grilles in the back. It should also have at least 36 inches (915mm) in front in order to change modules when necessary.

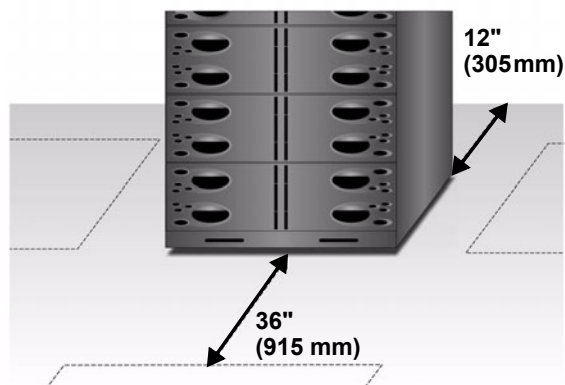

The unit frame is bolted to the shipping pallet to ensure safety. It is recommended that a pallet jack be used to transport the unit to its operating location (prior to unbolting the unit).

## 2.2 Unloading

### 2.2.1 Unloading the UPS



## CAUTION

This UPS is very heavy (see weight in **Table 1**). At least two people should assist in unloading it from the pallet.

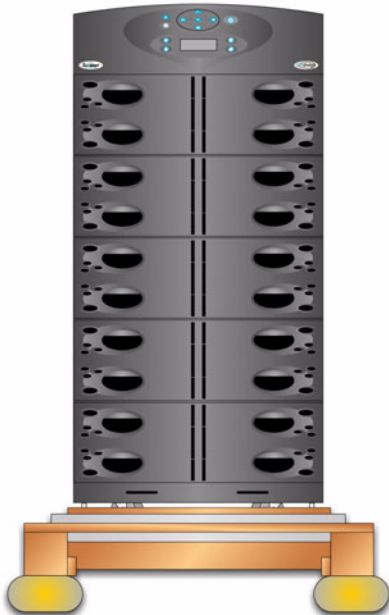

1. Use a ratchet or wrench, 1/2" (13mm), to remove the four mounting bolts from the front and rear pallet brackets. Remove the mounting brackets from the pallet and UPS. Keep the brackets for future transportation of the UPS or for additional stability of the UPS once in place.

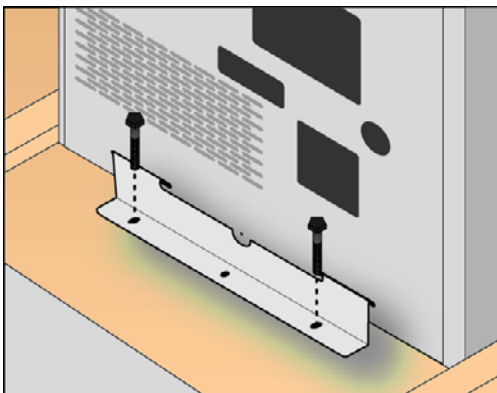

2. Remove the metal ramp from the bottom of the UPS.

**Pull ramp out from under front of unit, then turn ramp over**

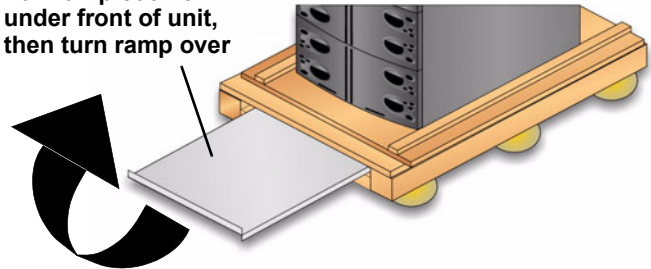

3. Fit the ramp flange in the slot in the rear of the pallet (back of unit) as shown below.

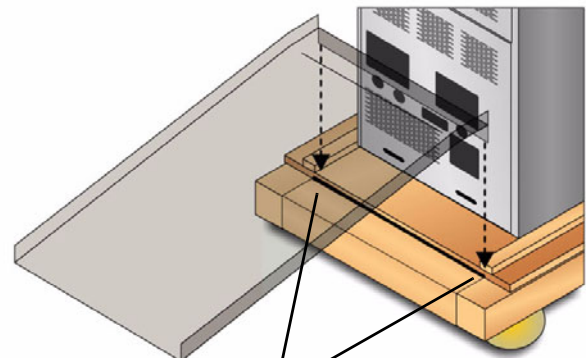

**Fit ramp in rear of pallet**

4. Using two people, slowly move the UPS down the ramp until the UPS is on a level surface.

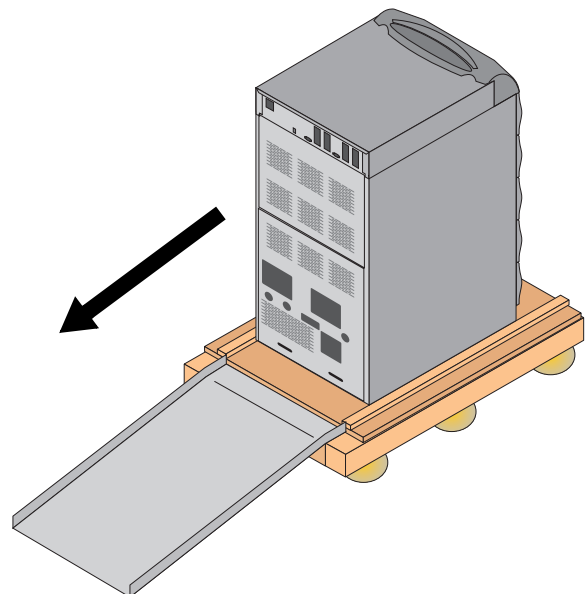

- Once the UPS is in the desired location, adjust the leveling feet to secure its position.



### 2.2.2 Stationary Mounting

Additional stability can be added by bolting the mounting brackets (used in shipping) to the floor, as shown below left.

**Shipping Brackets Used for Stationary Mounting**

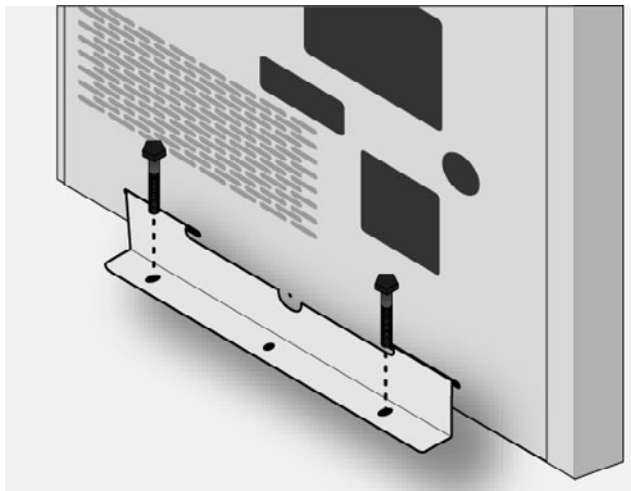

**Optional Stationary Mounting Dimensions**

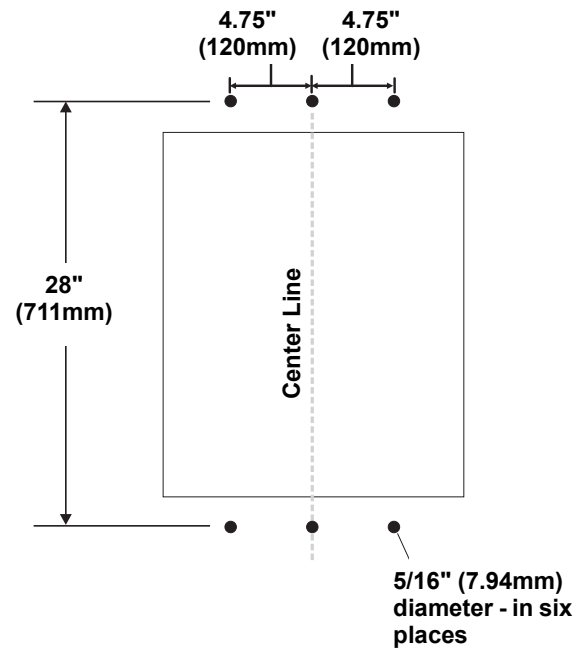

For greater stability, use a higher-grade bolt. Refer to the dimensions above right when drilling holes for stationary mounting.

## 2.3 Cable Installation

### 2.3.1 Wiring Preparation



## WARNING

Please read this section thoroughly before attempting to install wiring to this unit.

This UPS should be installed by a qualified / certified electrician.

### Removing the Cover Plates

On the back of the UPS, cover plates are over the input and output terminals, as shown at right. Keep screws and plates to one side.

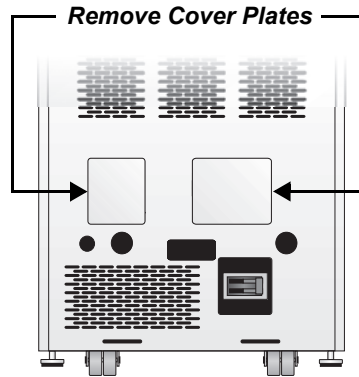

### Customer-Provided Overcurrent Protection

A branch rated overcurrent protection device (circuit breaker or fused disconnect switch) must be installed for the AC input.

If the start-up is on bypass, the UPS has a six-cycle inrush current that is up to 20 times the rated output current. This must be taken into account when selecting the overload protection device at the AC input supply distribution point. To avoid random tripping on start-up, it is recommended that the AC input supply be protected with a circuit breaker capable of withstanding this initial inrush.

This UPS is fitted with EMI suppression filters. Earth leakage current is less than 40mA. Transient and steady state earth leakage currents may occur when starting the equipment. This should be taken into account when selecting ground current detection devices, as the earth leakage currents of both the UPS and load will be carried.

Input and output cables must be run in separate conduits.

### Input Wiring (TB1)

To connect the input wiring, follow these steps:

1. Locate the input wiring access, remove the knockout and pull the three input wires through it, allowing some slack for installation.
2. Secure the conduit to the rear panel of the UPS.
3. Input Power cables connect to screw terminals on the Input Terminal Block located to the right of the Bypass Voltage Terminal. Connect the wires to the block connections as shown below. Using a torque wrench, turn the screws clockwise until tightened to the proper torque value (28 in-lb). Insert the ground wire through the grounding lug and tighten it to the proper torque value (120 in-lb).

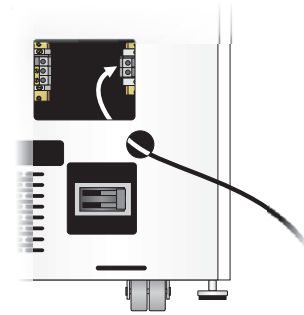

### Grounding Conductor Installation

An insulated grounding conductor must be identical or larger in size, insulation material, and thickness as the grounded and ungrounded branch circuit supply conductors. This cable must be green with or without one or more yellow stripes and is to be installed as part of the branch circuit that supplies the unit or system.

The grounding conductor is to be grounded to earth at the service equipment or, if supplied by a separately derived system, at the supply transformer or generator set.

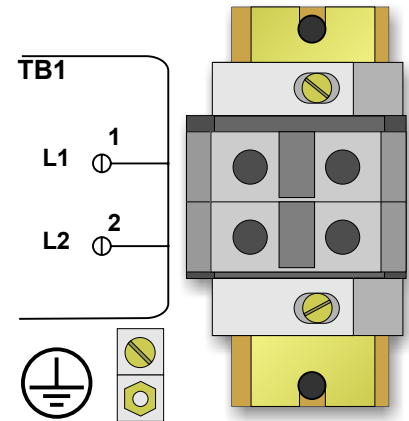

### Output Wiring (TB3)

Refer to the chart below and the diagram at right when configuring the output wiring.

Voltage	105	210
Between terminals	1 & 3, 2 & 3	1 & 2

Use only the connections listed above. Other connections will produce nonstandard voltages.



#### NOTE

The Nfinity UPS contains an isolation transformer that generates a neutral conductor for the connected equipment. The UPS is a separately derived source and contains a neutral to ground bonding jumper. A grounding electrode conductor (GEC) must be installed in accordance with national and local wiring codes and regulations.

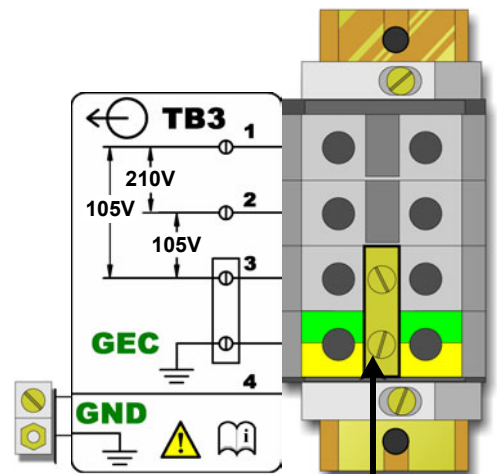

Note the Neutral / Earth jumper on the terminal above



### 2.3.2 Connecting to External Panel Boards

The following instructions are also shipped attached to the rear of the unit.

## INPUT CABLING AND PROTECTION

Table Below Applies to 4-16kVA Scalable Systems:  
Stand-alone UPS or  
UPS equipped with a Maintenance Bypass Cabinet

Max. System Load Rating	Input Voltage – 200/210VAC	
	Max. Current in UPS mode	Recommended Input Protection Circuit Breaker
4kVA	18 amps	50 amps
8kVA	36 amps	50 amps
12kVA	53 amps	75 amps
16kVA	70 amps	100 amps
Terminal Block Details	Maximum: 35 mm <sup>2</sup> (2AWG) Minimum: 16 mm <sup>2</sup> (6AWG) Torque Rating: 2.5-3.0Nm (22-26in/lbs)	

# OUTPUT CABLING

## UPS Output Terminal Block (TB3)      Connection to External Panel Boards

### 210 VAC

If connected equipment operates at 210VAC only, use a single-phase panel board connected to the UPS as follows.

#### Setup 1 - 210 VAC

Max output current = 76A

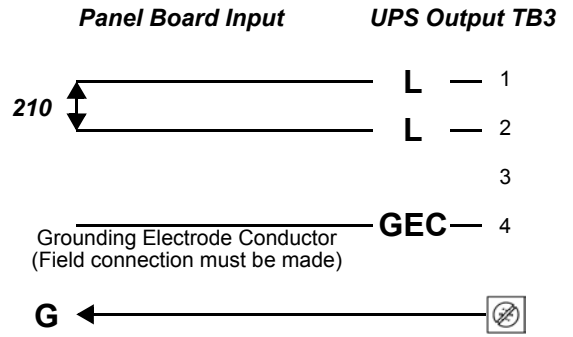
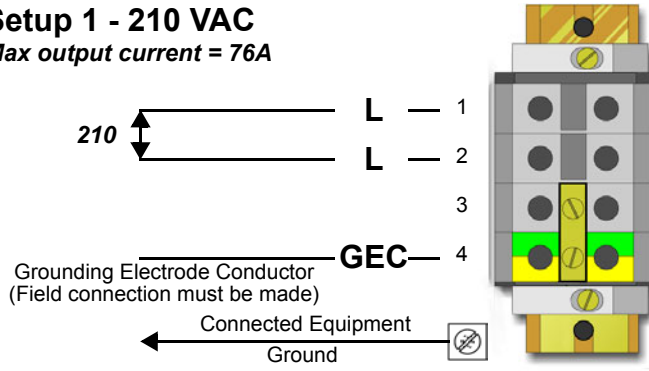

### 210VAC and/or 105VAC

If connected equipment operates at 210VAC only or 105VAC only or is a combination of both, use a single-phase panel board connected to the UPS as follows.

#### Setup 2 - 210/105 VAC

Max output current = 76A

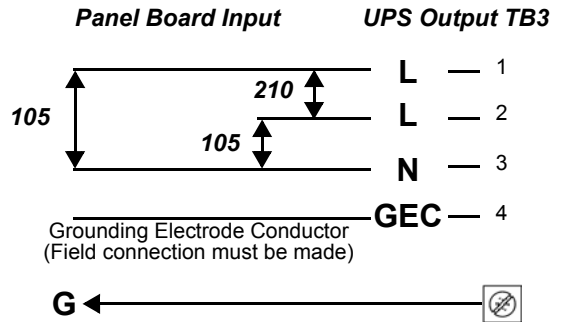
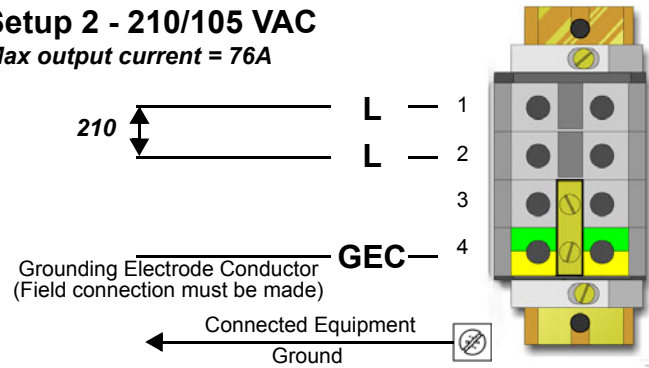

### 2.3.3 REPO Connection

The Nfinity is equipped with a Remote Emergency Power Off (REPO) connection.



**NOTE**

*A jumper is factory installed between pins 1 & 2 to disable the Control Switch (SW2). This will prevent the unit from being started during installation. This jumper must be removed in order to start the unit.*

Figure 2 REPO switch connections

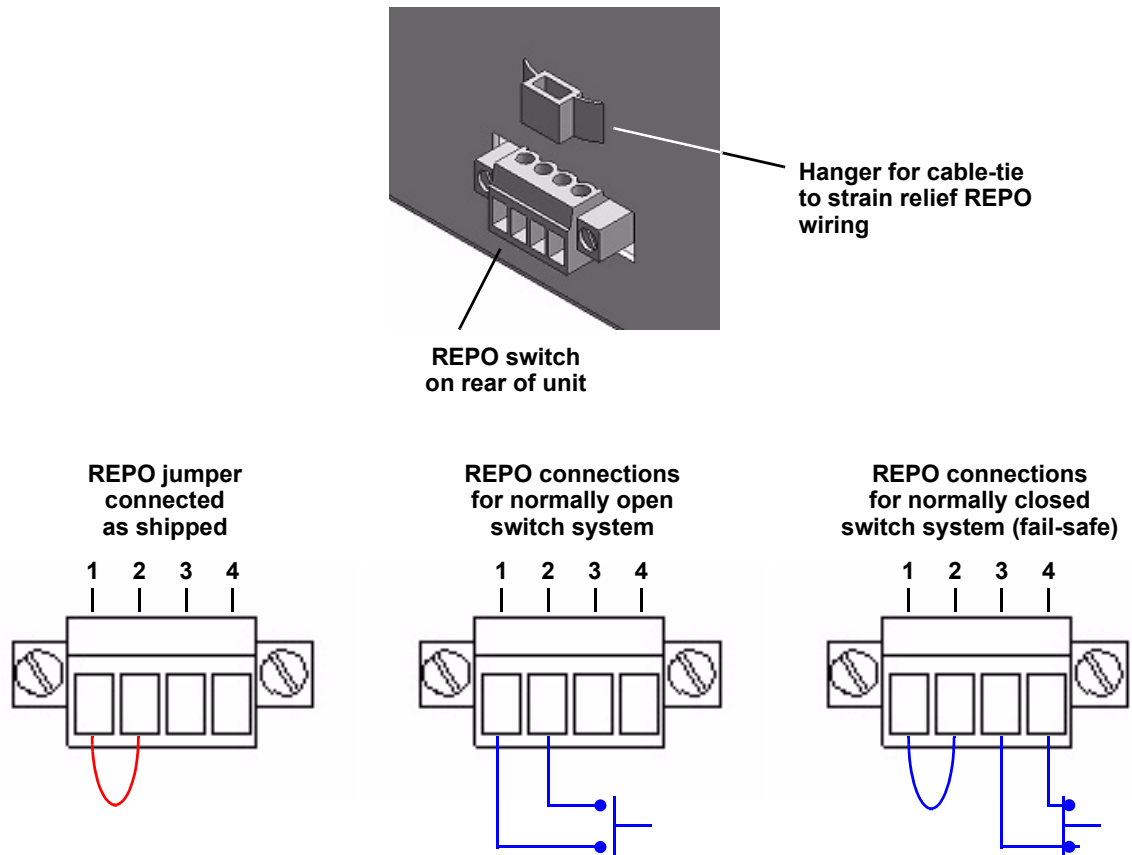

**NOTE**  
 Remove jumper before wiring.  
 If the installation does not require connection to a REPO system, the jumper must be removed.

**Key to REPO switch connections**  
 1. 24 V DC, 50mA  
 2. Sense  
 3. Sense  
 4. Ground



## CAUTION

To maintain safety, Signal Edge Low Voltage (SELV) barriers, and electromagnetic compatibility, signal cables should be segregated and run separately from power cables.

## 2.4 Communications

### 2.4.1 COM Ports

Nfinity is able to communicate through multiple communication ports simultaneously. Use only Liebert-provided communication cards. Connect only Signal Edge Low Voltage (SELV)/Class 2 circuits when connecting to any communication port.

There are two DB-9 COM ports available on the rear of the Nfinity.

#### COM1 - Relay Contacts

Relay contacts are available through a DB-9F communications connector. Contact closure provides the following:

Pin	Assignment
1	Low Battery (normally open)
4	UPS shutdown in battery mode (5-12 V DC for 1.5 sec)
5	Common
7	Low Battery (common)
8	On Battery (common)
9	On Battery (normally open)

These contacts are rated 48 VDC, 1 amp maximum and are compatible with Liebert MultiLink™ software.

#### IOIO COM2 - Serial

Nfinity is able to communicate via Liebert proprietary protocol. This communication port can be used for serial communication with Liebert MultiLink software. For more detailed information, please see the MultiLink software documentation on the CD shipped with the Nfinity. The pin-out configuration of the DB-9 connector is:

Pin	Assignment
2	Transmit Data
3	Receive Data
5	Common

### 2.4.2 Intellislot™ Ports

The following communication cards may be used with Nfinity:

- **Intellislot OpenComms Web Card**—allows the Nfinity to communicate intelligently with your Ethernet network. The OpenComms Web Card must be installed in port 1.
- **Intellislot MultiPort4 cards**—allows up to four client computer systems to monitor the status of Nfinity simultaneously.
- **Intellislot Relay Contacts cards**—provides contact closures for remote monitoring of alarm conditions; On Battery, On Bypass, Low Battery, Summary Alarm, UPS Fault and On UPS signals.

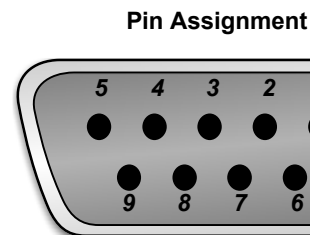
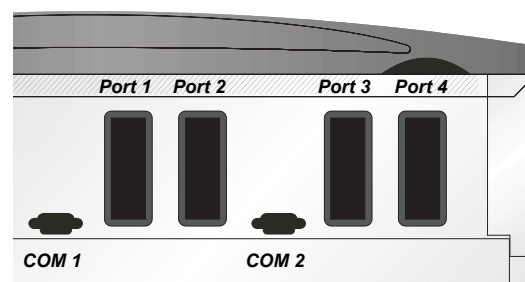

### 3.0 OPERATING INSTRUCTIONS









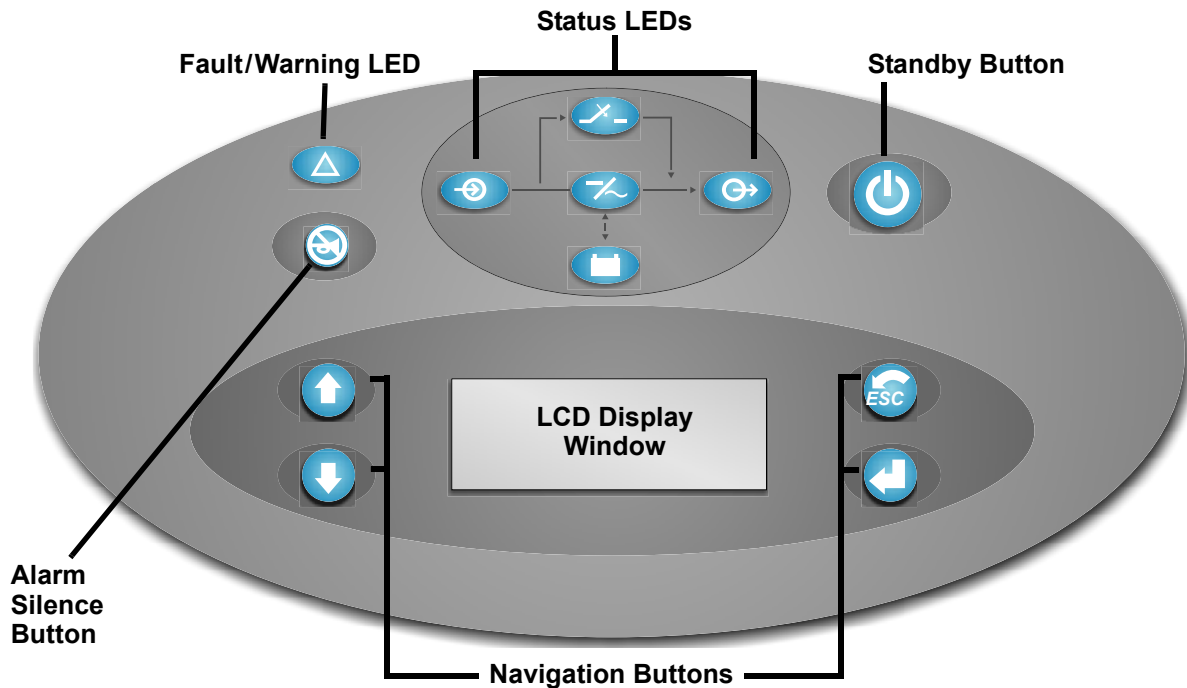



#### 3.1 Controls and Indicators

##### 3.1.1 Display Controls

The User Interface Module informs you of the status of the UPS and lets you configure the UPS to your own needs or preferences.

The module consists of a series of Status LEDs, an LCD display window (four lines of 20 characters each), and buttons for navigation, as displayed below.



Buttons	Fault/Warning and Status LEDs
Refer to the legend below to properly navigate the Nfinity User Interface.	Refer to the legend below to indicate occurrence when an LED is lit.
 <b>Up</b>	 <b>Fault/Warning</b> Solid - A UPS fault condition has occurred. Flashing - A Warning has occurred. Consult event log.
 <b>Down</b>	 <b>AC Input</b> - AC utility is available.
 <b>Escape</b> - Returns to previous display screen	 <b>On Bypass</b> - The Bypass is supplying the power.
 <b>Enter</b> - Selects displayed information	 <b>Inverter On</b> - The inverter is supplying the power.
 <b>Standby</b> - Enables / disables output power	 <b>On Battery</b> - Battery is supplying power to the inverter.
 <b>Alarm Silence</b> - Mutes the audible alarm	 <b>AC Output</b> - Power is available to supply the load.

### 3.2 Status LED Modes

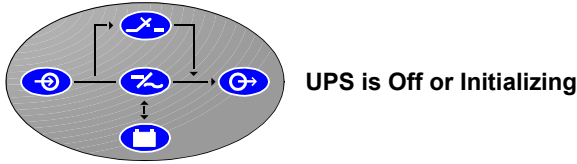

UPS is Off or Initializing

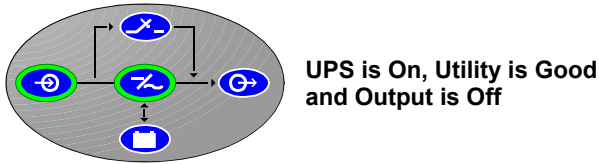

UPS is On, Utility is Good and Output is Off

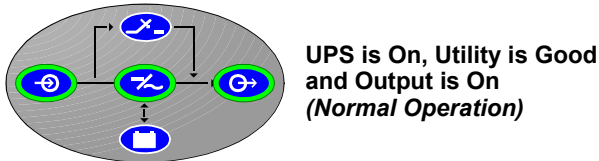

UPS is On, Utility is Good and Output is On (Normal Operation)

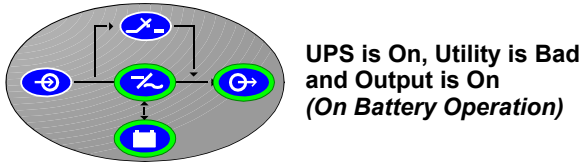

UPS is On, Utility is Bad and Output is On (On Battery Operation)

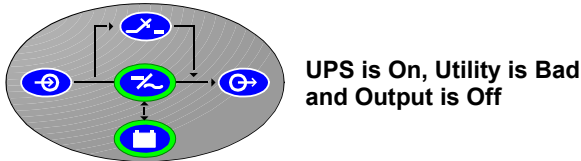

UPS is On, Utility is Bad and Output is Off

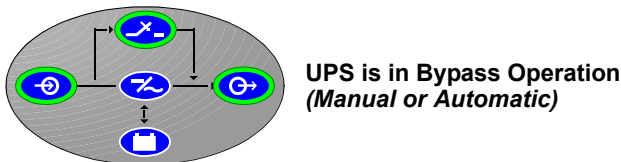

UPS is in Bypass Operation (Manual or Automatic)

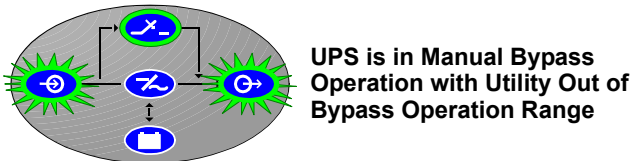

UPS is in Manual Bypass Operation with Utility Out of Bypass Operation Range

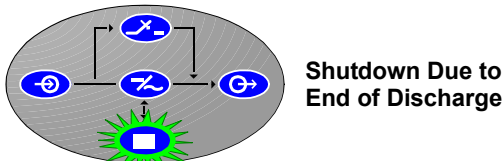

Shutdown Due to End of Discharge

	LED Off
	LED On
	LED Flashing

### 3.3 Navigating the Menu

To review or change any settings on the UPS, use the buttons on the User Interface shown at left. Because some menus contain more than four rows of information, you may see an arrow on the display pointing up or down (as shown below)—indicating to scroll using the **↑** or **↓** buttons.

If you are scrolling through any of the Main Menus, items will scroll one line at a time with the menu heading on the top line:

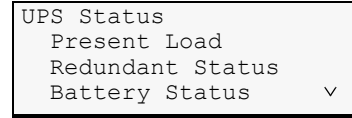

Pressing **↓** reveals:

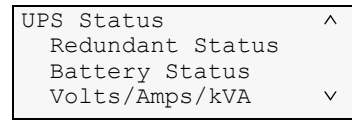

Note the arrows on the screen indicate that the user can scroll up or down to reveal more information.

### 3.4 Operating Procedures



#### 3.4.1 Start-Up and Initialization

Follow these steps to start up the UPS.

1. Ensure the manual bypass switch is in UPS position. Close Input Circuit Breaker (CB1) and close the Control Enable Switch (SW2). You should see the following on the LCD display window:

```
UPS Initializing
Please wait...
```

```
*Press  to Enable
UPS Output.
```



2. Press  or  button.

```
On Mains/Utility
Output % = xx
Battery Minutes yyy
Press  for menu
```

3. Press  to access the Main Menu.

#### 3.4.2 Shutting Down the UPS

Use the following procedure to power down the UPS.

1. Press  to disable power from the connected equipment.
2. Verify request to disable the output by pressing .
3. Turn off the Enable Switch (SW2). Open the Input Circuit Breaker (CB1).

#### 3.4.3 Manual Transfer to Bypass

To manually transfer the UPS to bypass, move the manual bypass switch to the bypass position. The manual bypass switch is behind the front bottom bezel. To transfer the UPS from bypass to normal mode, follow the on-screen instructions.

##### Main Menu

```
> Transfer to Bypass
```



##### Transfer to Bypass

```
Press  for bypass
Press ESC to cancel
```



```
Assert manual bypass
```

Once  is pressed, the bypass alarm will annunciate and cannot be canceled until the manual bypass switch is operated.

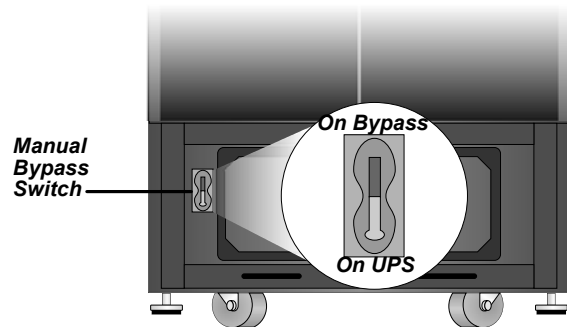

```
UPS on manual bypass
```



##### NOTE

*The load is not protected from utility interruptions when the UPS is in bypass mode.*

To transfer the UPS from bypass to normal mode, simply operate the manual bypass switch back to the UPS position.

On return from bypass, the following screen will be displayed.

```
No active alarms
See Event Log
```

### 3.5 Main Menu

After initialization, the **↵** button will take you to the Main Menu. From here you may check on the status of the UPS, review the event log and active alarms, configure your UPS and even receive instructions on replacing modules. The Main Menu is divided into eight sub-menus as shown below:

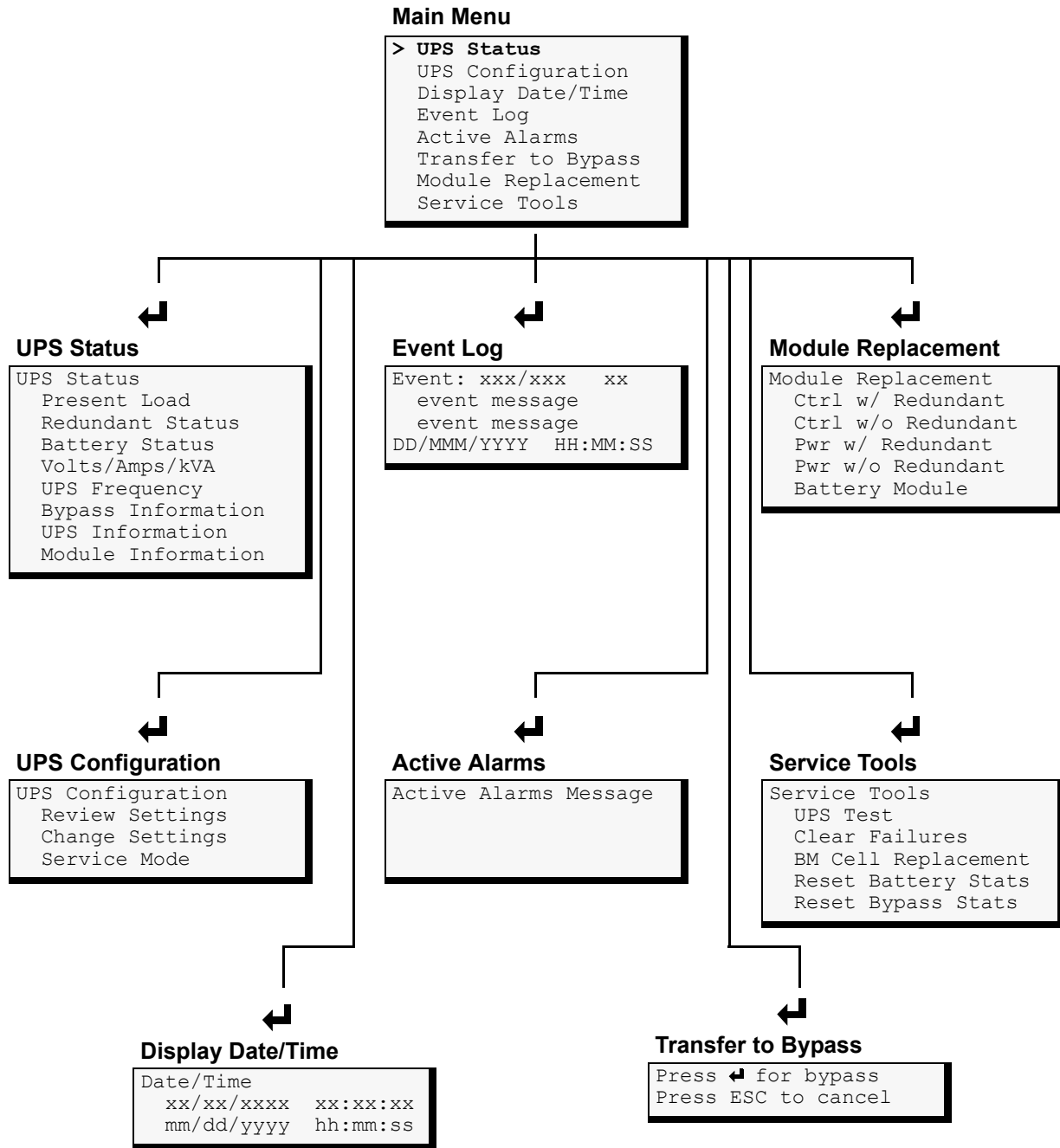

Use the **↑** and **↓** buttons to select the desired menu item and press **↵** to access the appropriate submenu.



### 3.5.1 UPS Status Screen

From the Main Menu the user may select UPS Status and press **↩**. Once at the UPS Status Screen, the user may access any information on the present condition of the UPS. Note the chart below when reviewing the UPS.

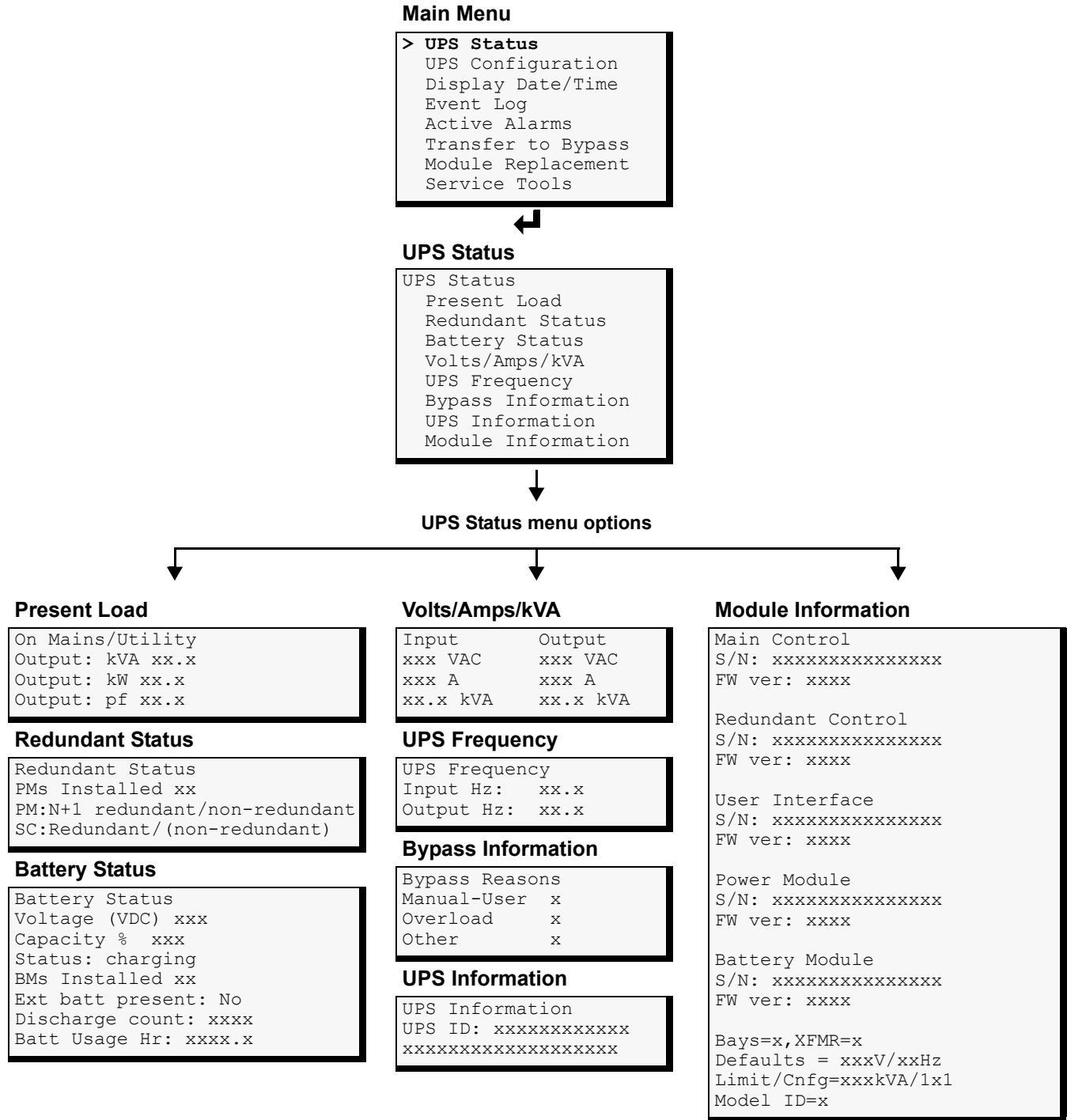

### 3.5.2 UPS Configuration Screen

#### Review Settings

Follow this procedure to review your UPS configuration settings. Follow the menus below by pressing **↑** and **↓** to review the settings.

#### Main Menu

```

UPS Status
> UPS Configuration
  Display Date/Time
  Event Log
  Active Alarms
  Transfer to Bypass
  Module Replacement
  Service Tools
    
```



#### UPS Configuration

```

UPS Configuration
> Review Settings
  Change Settings
  Service Mode
    
```



#### Review Settings

```

Voltage
Frequency
Battery
Alarms
Service Contact
Auto Restart
UPS Shutdown Delay
Remote Shutdown
External Battery
Bypass Alarm Mode
Intelli-Battery Ca.
Air Filter Reminder
Guarantee Shutdown
    
```



#### Review Settings menu options



#### Voltage

```

Voltage Settings
Input 210
Output 210
    
```

#### Frequency

```

Frequency Settings
Frequency Hz: 50/60
Sync Range Hz: +/- 5.0
Slew Range Hz/S: 3.0
    
```

#### Battery

```

Battery Settings
Test intrvl weeks: 2
on Wed 06:00
Low Batt Warn:2 min
    
```

#### Alarm

```

Alarm Settings
Redundant Alarm:
  Enabled/Disabled
Max Load: Enabled/Disabled
    
```

#### Service Contact

```

Service Contact
Liebert Corp.
www.liebert.com
    
```

#### Auto Restart

```

Auto Restart
Mode: Disable
Batt % 0%
Delay 10
    
```

#### UPS Shutdown Delay

```

UPS Shutdown Delay
120 seconds
    
```

#### Remote Shutdown

```

Remote comm shutdown
Mode: Enable
    
```

#### External Battery

```

External batt config
Amp.Hr 0000
Charge (A) 00.0
    
```

#### Bypass Alarm Mode

```

Bypass Alarm Mode
Mode: Enable
    
```

#### Intelli-Battery Ca.

```

Intelli-Batteries
0
    
```

#### Air Filter Reminder

```

Air Filter Reminder
Mode: 26 weeks
    
```

#### Guarantee Shutdown

```

Guarantee Shutdown
Mode: Enable/Disable
    
```

## Change Configuration Settings - Change Settings Menu

Starting from the Main Menu, locate and press UPS Configuration. From the UPS Configuration screen, select the Change Settings option. You may configure Nfinity from a large variety of selections. Items indicated by an asterisk (\*) are the selected settings.

### Main Menu

```

UPS Status
> UPS Configuration
  Display Date/Time
  Event Log
  Active Alarms
  Transfer to Bypass
  Module Replacement
  Service Tools
    
```



### UPS Configuration

```

UPS Configuration
  Review Settings
> Change Settings
  Service Mode
    
```



### Change Settings

```

Frequency
Frequency Sync Range
Frequency Slew Rate
Set Password
Auto Battery Test
Low Battery Warning
Auto Restart
User Settings
Set Date/Time
Max Load Alarm Set
UPS Shutdown Delay
Redund Alarm Set
Service Contact
Remote Shutdown
External Battery
Bypass Alarm Mode
Intelli-Batt Ca.
Air Filter Reminder
Guarantee Shutdown
Line Compensation
Factory Defaults
    
```

**Frequency:** Sets the output frequency.

```

Output Frequency
  50 Hz
* 60 Hz
    
```

**Frequency Sync Range:** Sets the window to which the system synchronizes to the input supply.

```

Frequency Sync Range
  0.5 Hz
  1.0 Hz
  2.0 Hz
  3.0 Hz
  4.0 Hz
* 5.0 Hz
    
```

**Frequency Slew Rate:** Sets the rate of change of frequency through the sync range window.

```

Frequency Slew Rate
  0.5 Hz
  1.0 Hz
  2.0 Hz
  3.0 Hz
  4.0 Hz
* 5.0 Hz
    
```

**Set Password:** Set a Password to prevent unauthorized users from changing the configuration of the Nfinity. It can be up to seven characters in length. Once set, the password will be required to change the configuration.

```

Set Password
  xxxxxxxx
    
```



### NOTE

*If the password is lost, call Liebert Technical Support.*

**Auto Battery Test:** Configure when and how often the Nfinity's automatic battery test will run. This test is designed to ensure battery system integrity and provide early warning of problems.

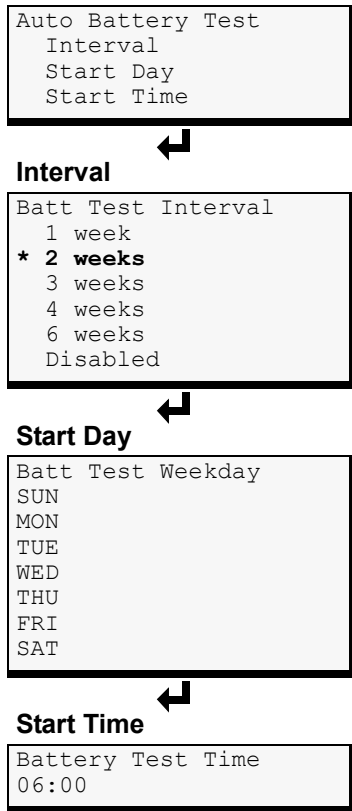

**Low Battery Warning:** Notifies user how much run time is available. Can be set from 1 to 30 minutes.

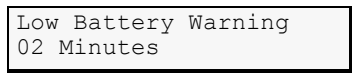

**Auto Restart:** Automatically restarts once both delay parameters (battery capacity percentage and countdown timer) are met.

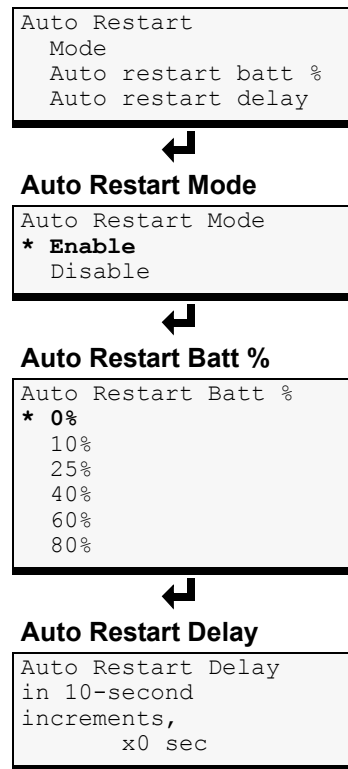

**User Settings:** You may adjust the contrast of the user interface LCD or select the appropriate language.

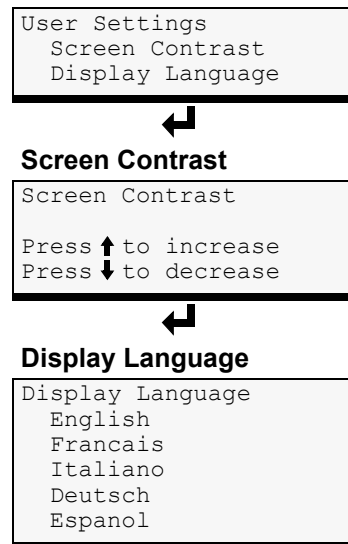

**Set Date/Time:** Allows user to enable/disable DST (Daylight Saving Time), change the Day, Date and Time setting on Nfinity. When enabled, the time will automatically adjust to Daylight Saving Time.

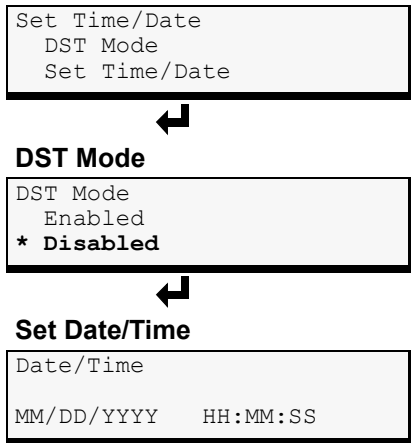

**Max Load Alarm Set:** Allows an alarm to set when Nfinity's load reaches a specific level.

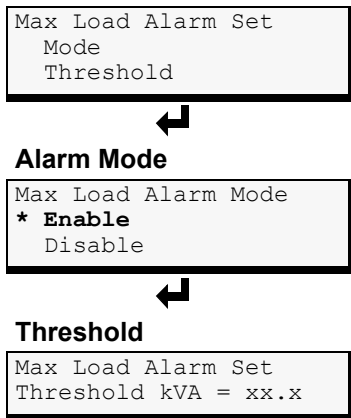

**UPS Shutdown Delay:** Delays UPS shutdown for specified amount of time after receiving shutdown command via relay contacts only.



**Redundant Alarm Set:** Sets Alarm to notify user when redundancy is no longer available.

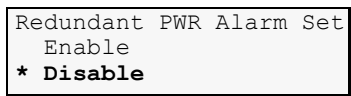

**Service Contact:** Set a contact for the user to reach if problems occur.

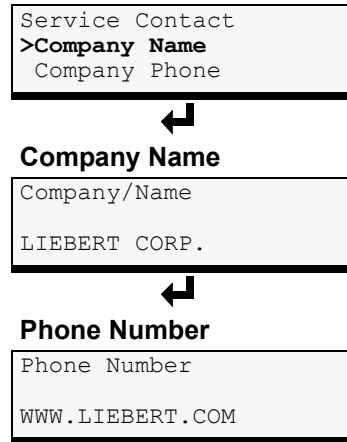

**Remote Shutdown:** Enables / Disables the Remote Communications Shutdown.

If you are using MultiLink™ software, this parameter should be enabled in order for the UPS output to be turned off once the operating system has been shut-down.

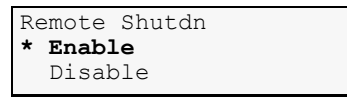

**External Battery:** Sets total amp-hour for external batteries to provide a more accurate runtime remaining value on the LCD display and through communications.

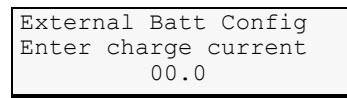
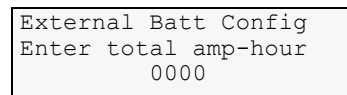
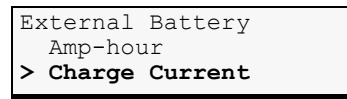

When using the Non-Modular External Battery Cabinets with Chargers (P/N: PB10SLF105WC120), enter the following:

# Cabinets	AH Value	Charge Current
1	0091	07.0
2	0182	14.0
3	0273	21.0
4	0364	28.0
5	0455	35.0
6	0546	42.0

**Bypass Alarm Mode:** Allows the user to enable/disable alarm, indicating that the bypass is not qualified.

```
Bypass Alarm Mode
> Enable
  Disable
```

**Intelli-Battery Ca.:** Allows the user to enter the quantity of intelligent battery cabinets installed.

```
Enter Intelli-
Battery cabinet
count
      x
```

**Air Filter Reminder:** Allows the user to set a warning reminder to check the air filters.

```
Air Filter Reminder
2 weeks
4 weeks
10 weeks
26 weeks
52 weeks
* Disable
```

**Guarantee Shutdown:** Allows the user to guarantee a shutdown after a low battery warning is announced, even if the utility becomes qualified.

```
Guarantee Shutdown
  Enable
* Disable
```

**Line Compensation:** Allows the user to control the amount of line drop compensation to be applied to the nominal output voltage. Line drop compensation is intended to compensate for any IR drop that may occur when the UPS is a significant distance from the protected load.

```
Output Volt: x
↑Increase ↓Decrease
ESC to cancel
← to Accept & Exit
```

**Factory Defaults:** Allows the user to reset all settings to the values in effect when the UPS was shipped from the factory.

```
Load Factory Default
Are you sure?
Press ← for yes
Press ESC for no
```

## UPS Configuration Screen - Service Mode Menu

Service Mode contains site identification information about the UPS system. The data is entered by Liebert Global Services (LGS). To view the data, go to the Main Menu, select UPS Configuration and press **←**. Next, select Service Mode and press **←**.

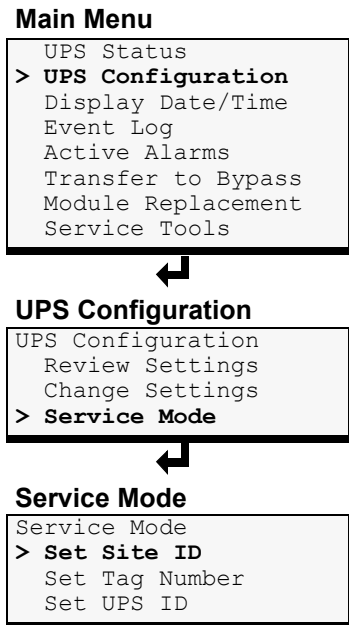

**Set Site ID:** Press **ESC** to return to the Service Mode menu. Scroll to Set Site ID and press **←** to display the screen shown below.

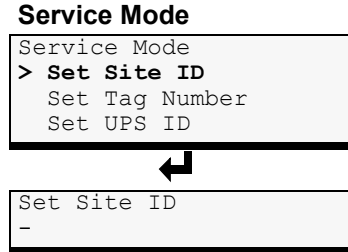

**Set Tag Number:** Press **ESC** to return to the Service Mode menu. Scroll to Set Tag Number and press **←** to display the screen shown below.

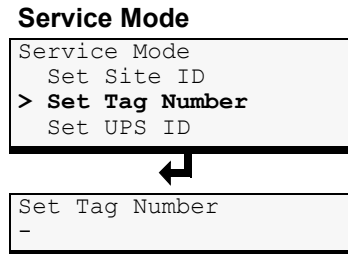

**Set UPS ID:** Press **ESC** to return to the Service Mode menu. Scroll to Set UPS ID and press **←** to display the screen shown below.

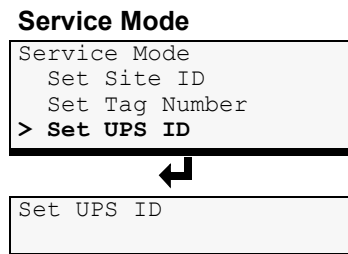

### 3.5.3 Display Date/Time

This feature shows the current date and time. At the Main Menu, select UPS Configuration and press **←**. Next, select Display Date/Time and press **←**.

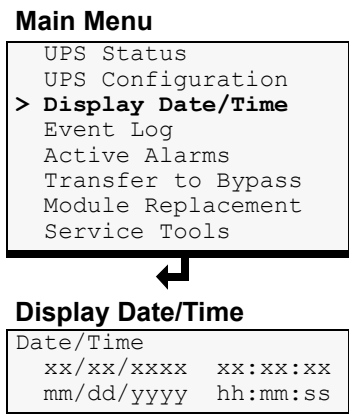

### 3.5.4 Event Log

Accessing the Event Log enables the user to scroll through the Nfinity's past 255 occurrences. To open the Event Log, start at the Main Menu, select Event Log and press **↵**.

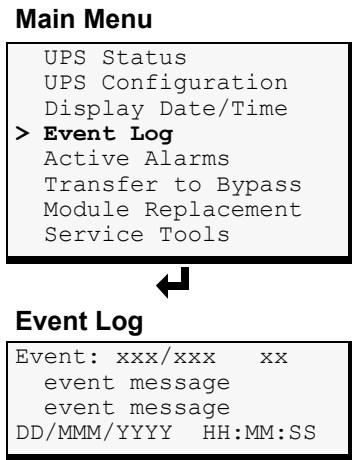

Press the **↑** and **↓** buttons to scroll through the Nfinity's Event Log in chronological order. The Event Log contains the following information.

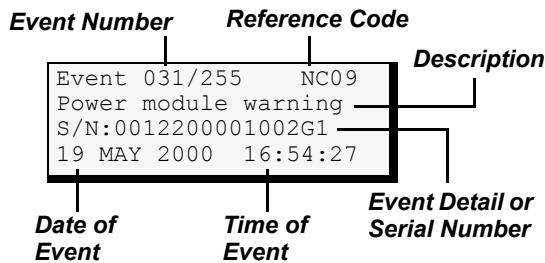

The typical event log screen will display the event number and reference code on the first line. The purpose of this code is to assist factory trained service personnel in troubleshooting. Please make a note of the code number when contacting technical support. The second line contains the event description. The third line will have either more detail about the event, a serial number indicating as to which module the event occurred, or be left blank. The last line will show the date and time the event occurred.

Press **ESC** to go back to the Main Menu.

When an event or alarm occurs, the User Interface LCD will display the last message regardless of the default screen. See 4.1 - **Active Alarms** for a list of events and alarms and possible solutions. If you are unsure of the corrective action to take, contact a Liebert representative at the number listed on the back of this manual.

### 3.5.5 Active Alarms

Alarms affecting the Nfinity can be viewed at the Active Alarms screen. To access the screen, go to the Main Menu, select Active Alarms and press **↵**.

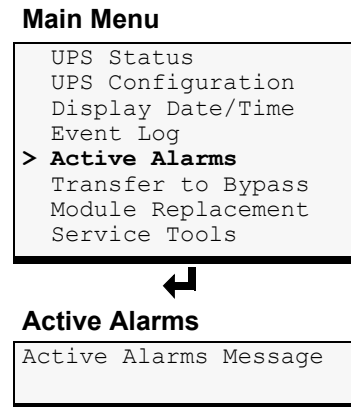

When an alarm sounds, the User Interface LCD will display a general explanation as to what the alarm is indicating. To view these messages in chronological order, press the **↑** and **↓** buttons.

- The first line of a typical Active Alarms screen will display the reason for the alarm occurrence.
- The second line will give a more specific detail of the occurrence (i.e., module serial number).

Press **ESC** to go back to the Main Menu.

### 3.5.6 Transfer to Bypass

In the event of a UPS overload or failure, the UPS will transfer to bypass via its automatic bypass switch.

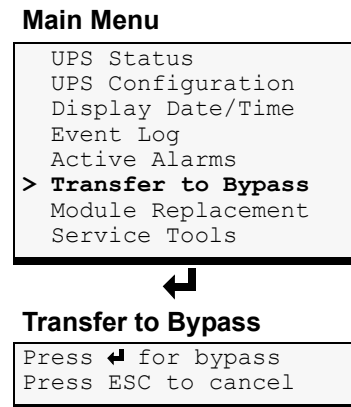



### 3.5.7 Module Replacement

The user interface also supplies instructions for removing and replacing modules. From the Main Menu, access the module replacement screen and select the type of module. Refer to the screens below:

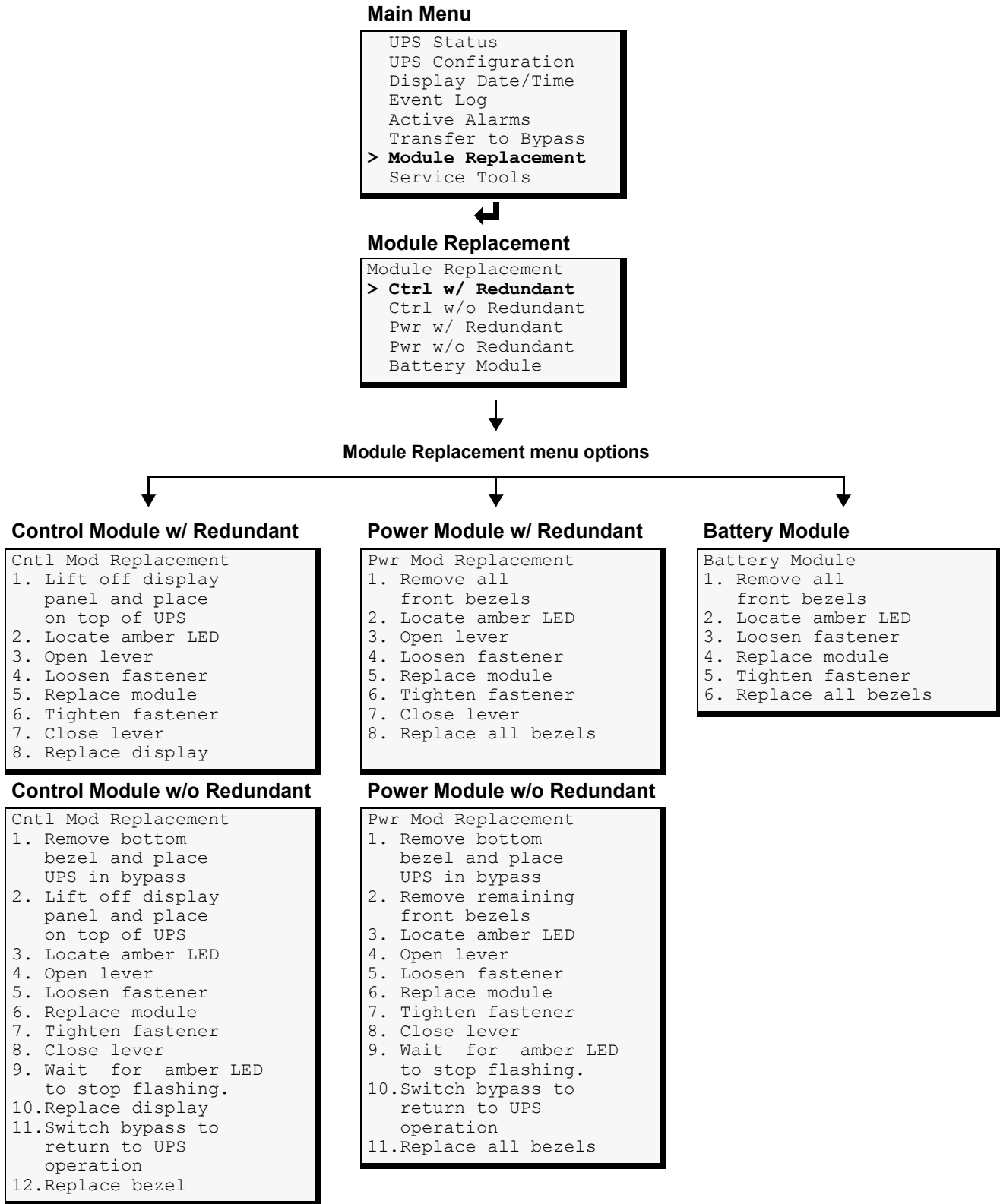

For more details on module replacement, consult **4.0 - Troubleshooting**.

### 3.5.8 Service Tools for Liebert Global Services Engineers

The Service Tools option is intended for use by Liebert Global Services engineers or Liebert-trained engineers to carry out certain tests and clear failures. These are advanced menus, entering changes may adversely affect UPS operation. From the Main Menu, shown below left, select Service Tools and press **↵**.

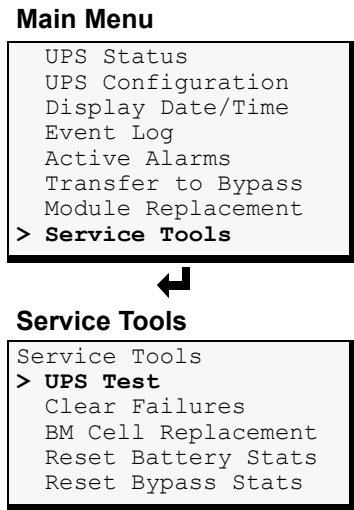

**BM Cell Replacement:** Allows a Liebert-trained engineer to reset the battery module (BM) energy values to defaults after replacing battery cells within the module.

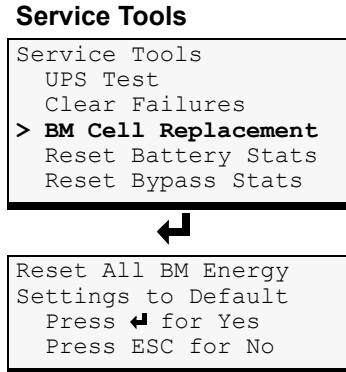

**UPS Test:** Allows a Liebert-trained engineer to test the Batteries, LEDs or LCD.

**Reset Battery Stats:** Allows a Liebert-trained engineer to reset all battery statistics. These statistics include battery usage and discharge count.

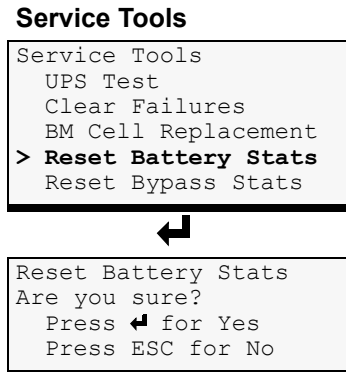
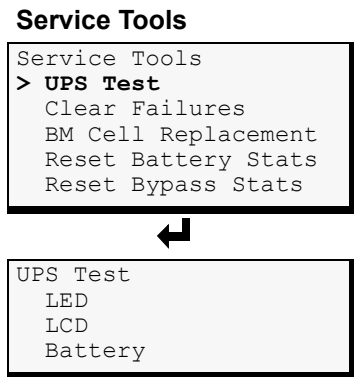

**Clear Failures:** Allows a Liebert-trained engineer to reset the UPS after a Battery Module failure alarm.

**Reset Bypass Stats:** Allows a Liebert-trained engineer to reset all bypass statistics. These statistics include manual bypass count, bypass overload count and other bypass count.

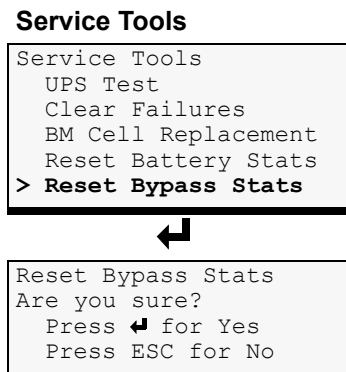
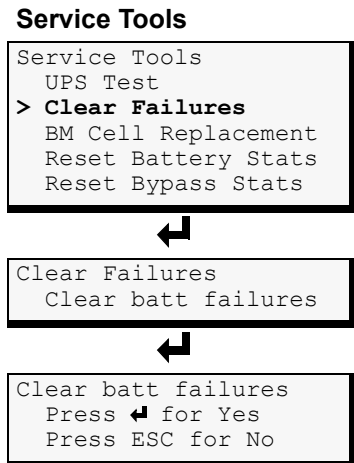

## 4.0 TROUBLESHOOTING

### 4.1 Active Alarms

In the event of an alarm, the User Interface LCD will display the last message regardless of the default screen. A list of possible alarm messages is displayed below. If you encounter one of these or other alarm messages and are unsure of the corrective action to take, please contact a qualified Liebert representative at the number listed on the back of this manual.

User Interface Text	Cause	Action
Main Control Failure	The Nfinity system has detected a System Control Module failure.	Identify and replace the failed System Control Module or contact Liebert Global Services for support.
Power Module Fail	The Nfinity system has detected a Power Module failure.	Identify and replace the failed Power Module or contact Liebert Global Services for support.
Battery Module Fail	The Nfinity system has detected a Battery Module failure.	Identify and replace the failed Battery Module or contact Liebert Global Services for support.
Redun. Control Fail	The Nfinity system has detected a System Control Module failure.	Identify and replace the failed System Control Module or contact Liebert Global Services for support.
Battery Card Failure	The Nfinity system has detected an Intellislot Battery Card failure.	Identify and replace the failed Intellislot Battery Card or contact Liebert Global Services for support.
UPS On Battery	The Nfinity is drawing power from the batteries, not from utility.	Verify input breaker is closed. Verify input voltage is present and correct voltage. Verify input frequency is correct.
Reminder alarm - Check air filter	The fan filter reminder time has elapsed.	Check and clean the fan filter and acknowledge the alarm. This alarm may be disabled or the interval between these alarms can be configured via the User Interface.
Short Circuit Recovery - Please Wait	User tried to turn the output on following a short circuit on the output without waiting for the required 30 seconds to expire.	Wait for at least 30 seconds and then turn the output on.
Power Module N+1 Redundancy Alarm	Number of power modules is not adequate to provide power redundancy.	Reduce the UPS's load, add power modules to the frame or disable the alarm feature via the User Interface.
Output Off - Output Short Circuit	A short circuit was detected on the output.	Correct short (or extreme overload condition) and turn on the UPS's output.
UPS Output Overload	The load on the Nfinity exceeded the capacity of the active power modules.	Reduce the UPS's load or add power modules.
Output exceeds max load setting	This will occur if the max load alarm is enabled, and the measured load at the UPS's output is greater than the value set.	Reduce the UPS's load, increase the Maximum Load Alarm limit via configuration or disable the Maximum Load Alarm limit via configuration.
Output Off-Overload, bypass unavailable	Normally a severe overload will cause the unit to go to automatic bypass. This event informs the user that bypass was not qualified so the unit dropped the load to protect itself.	Reduce the UPS's output load and verify that the UPS's bypass source is qualified (amplitude and frequency). Verify that the configuration voltage and frequency settings are properly selected.
Switch To Manual Bypass	The Nfinity is on automatic bypass. Manual bypass switch should be activated before servicing.	Transfer Nfinity to manual bypass and call Liebert service for assistance.
Load Exceeds Battery Module Capacity	The measured load on the output will cause the battery modules to exceed their limits if the UPS transfers to battery mode.	Reduce the UPS's load or add battery capacity. If external non-modular battery cabinet(s) are added, verify that the UPS's configuration is set to match the external battery amp-hour rating and charger rating.
Bypass source not qualified	The input voltage is not within the specified voltage or frequency range so the UPS will not allow an automatic or manual transfer to bypass.	Verify UPS's configuration for voltage and frequency. Check UPS's input breaker; disable this alarm if desired via configuration.
Load exceeds frame limit	Load is greater than the rated frame limit.	Reduce the UPS's load.

User Interface Text	Cause	Action
Assert manual bypass	A user-initiated transfer to bypass will assert this alarm, instructing the user to enable the manual bypass switch. Once the manual bypass is asserted, the alarm will clear. This is a non-mutable alarm.	Engage the manual bypass switch (located at the bottom front on the left hand corner of the unit). Once engaged, the switch may be de-asserted to return to normal operation.
Remote shutdown on COM port 1 active	The most likely cause is that the incorrect cable has been connected to the COM port between the UPS and the host.	Check for a wiring problem to the Shutdown On Battery at the COM1 connector. If this problem is not addressed, the unit will shut down shortly after switching to battery operation.
Battery Test Weak Battery	The battery was determined to be weak as a result of the battery test.	Depending on the age of the batteries, it may be appropriate to replace all batteries in the system. Schedule a battery test so that the system operation is double-checked once the batteries become fully charged.
Battery Test Failure	One or more of the following was detected during a battery test: <ul style="list-style-type: none"> <li>• UPS output regulation failure was detected.</li> <li>• A battery module warning or failure occurred.</li> <li>• A system control failure occurred.</li> </ul>	Replace the battery modules that have active failures/warnings. Depending on the age of the batteries, it may be appropriate to replace all batteries in the system. Schedule a battery test so that the system operation is double-checked once the batteries become fully charged.
Battery Cabinet Not Connected	This is intended to detect a situation where a Modular battery cabinet has been connected for communication, but the power busses are not connected.	Check that the Modular Battery breaker is closed. Verify proper connections between UPS and Modular Battery Cabinet.
Don't Remove SC	The only good System Control Module lock lever was raised with the output on and the unit is not on bypass.	<ul style="list-style-type: none"> <li>• Lower the lock lever on the System Control Module.</li> <li>• Provide qualified bypass power so that transfer to bypass is possible.</li> <li>• Add a redundant System Control Module so that the load is not dropped.</li> </ul>
Failure: Select Manual Bypass	The System Controller detected a failure. Select manual bypass so that the unit can be serviced.	Transfer UPS to manual bypass and contact Liebert Global Services.
Output Off - bypass unavailable	This event informs the user that bypass was not qualified so the unit dropped the load to protect itself.	Verify that the UPS's bypass source is qualified (amplitude and frequency). Verify that the configuration voltage and frequency settings are properly selected.
Last UPS Shutdown By Emergency Power Off	REPO switch was pressed.	If REPO wasn't pressed, check for REPO wiring problems.
External Battery Module Warning	The energy delivered from the Non-Modular battery did not meet programmed battery capacity.	Verify proper connections between UPS and Non-Modular Battery Cabinet. Reenter the amp-hour rating for the external battery (set the amp-hour entry to zero and press the return key, then reset it to the appropriate value for the external battery). If the problem persists, the external battery should be replaced.
Battery Module Not Ready	A battery module is not ready. In most cases, one or more battery modules should indicate a warning/failure condition.	Ensure that the battery module is fully seated and the 1/4 turn fastener is engaged. If the problem persists, replace the battery module with warning/failure condition indicated at the User Interface. If no User Interface warning/failure of battery module, look for the battery module with LEDs indicating a problem and replace that unit.
Power Module Not Ready	A power module is not ready. In most cases, one or more power modules should indicate a warning or failure condition.	Ensure that the power module is fully seated and the 1/4 turn fastener is engaged. If the problem persists, replace the power module with warning/failure condition indicated at the User Interface. If no User Interface warning/failure of power module, look for the power module with LEDs indicating a problem and replace that unit.

## 4.2 Module LED Indication

Every Battery, Power and Control Module features two LEDs to help inform the user of the module status, as shown below left. Refer to **Table 2** for details.

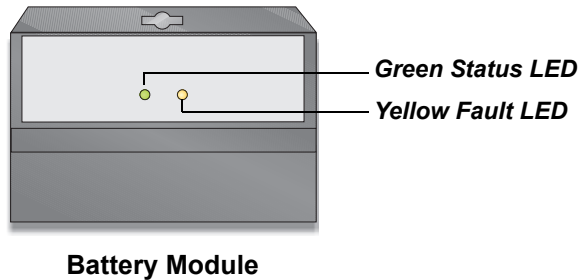
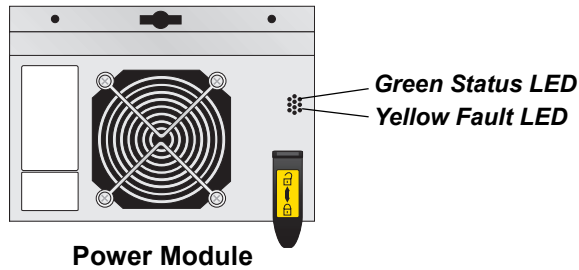
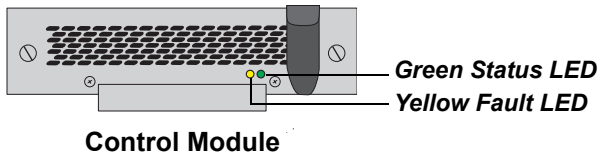

**Table 2** Guide to LEDs

Status LED (Green)	Fault LED (Yellow)	Module Status
OFF	OFF	Module not inserted into frame. System is OFF.
OFF	ON	Module is initializing (max 30 seconds*).
FLASHING	OFF	Normal Operation
FLASHING	FLASHING	Module is in start-up qualification mode or module warning. **
FLASHING	ON	Module failed and is off-line.
OFF	FLASHING	Abnormal operation, re-insert module.
ON	OFF	
ON	ON	
ON	FLASHING	

\* If this persists for more than 30 seconds, check to verify the lever is in the down position, otherwise the module is faulty.

\*\* If both green and yellow LEDs are flashing for more than 30 seconds, then reinsert module.

### 4.3 Module Replacement

Follow the instructions below when replacing or adding a Control, Battery or Power Module to the system.

To order additional modules, contact your Liebert representative or call 1-800-LIEBERT.

#### 4.3.1 Removing Modules

1. Remove bezel cover of appropriate module. When replacing a Power or Battery Module, verify the faulty module by confirming the yellow LED is lit.
2. If removing a Control or Power Module with no redundant modules, switch UPS to manual bypass.
3. Pull out and lift the lever if replacing a Control or Power Module, then turn fastener counterclockwise until it is loosened.

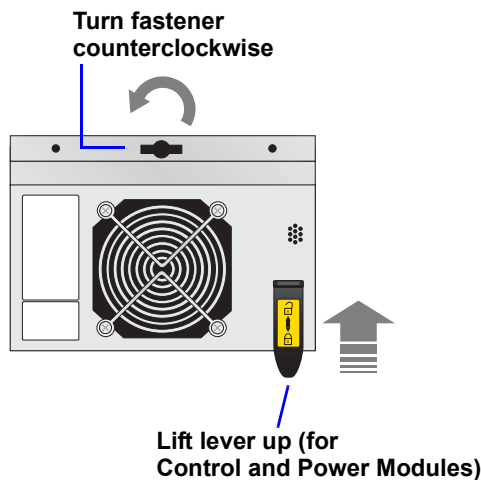

4. To remove the module:
  - a. Start to pull out module (shown above right, top). About 2/3 out it will stop.

### CAUTION

Battery Modules are heavy—66 lb (30 kg).

- b. Slide module away from the center of the UPS (shown above right, center).
  - c. Continue to pull until module is removed (shown above right, bottom).
5. Dispose of module in an environmentally responsible way that complies with local codes/regulations or return to Liebert for proper disposal.

 **NOTE**  
*Battery Modules may contain shipping screws. These screws may be removed and discarded.*

#### MODULE REMOVAL (Steps 4a-c)

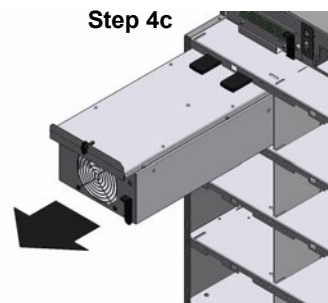
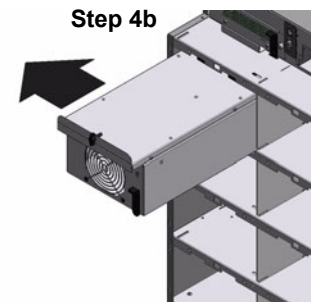
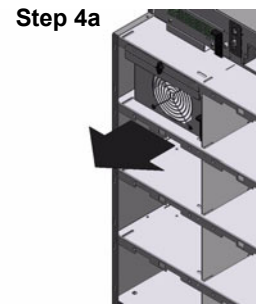

WARNING	
	<p><b>POTENTIAL TIP HAZARD</b>                      Install all battery modules starting from the bottom. For module removal, start from the top. Do not remove more than one module at a time. Failure to do so may cause unit to tip over and cause serious injury.</p>

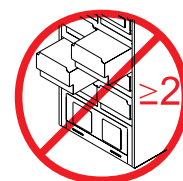
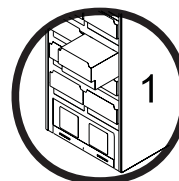

### 4.3.2 Adding or Replacing Modules



**NOTE**

*Power Modules must be installed in the top half of the Nfinity frame. Battery Modules can be installed in any bay of the UPS frame.*

1. Lift module to appropriate bay, resting end of module on bay shelf. Use caution not to rest the module on the lower bezel cover.
2. Push module into bay. Once halfway in, slide module sideways toward the center of the UPS. Continue pushing module until fully inserted.
3. Press and turn fastener clockwise until locked. If replacing a Control or Power Module, press lever down.
4. Wait about 15 seconds as the module performs a start-up test and synchronizes with the other modules. Both the yellow and green LEDs should be flashing. A green flashing LED will then confirm the module is properly installed.
5. If UPS was placed in bypass manually, transfer back to UPS operation.
6. Replace bezels.

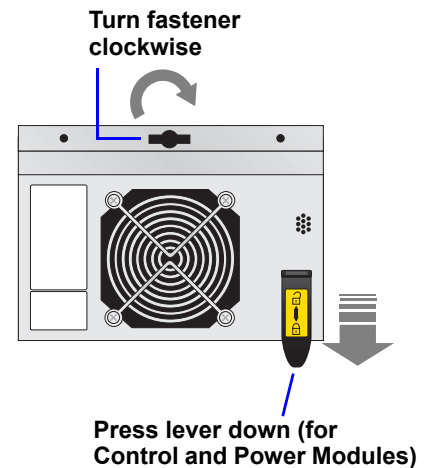

**NOTE**

*When replacing the Control Module, record user configuration data before removing. Re-verify the configuration settings after the new Control Module is installed.*

### 4.3.3 Replacing the User Interface

1. Lift off user interface and set it on top of the UPS frame.
2. The attached cable will be connected to an Intellislot card, found in a port between the control modules.
3. Remove the cable and the attached Intellislot card from the UPS.
4. Plug the new Intellislot card into the UPS.
5. Plug the new user interface cable into the Intellislot card.
6. Set replacement User Interface into proper position.

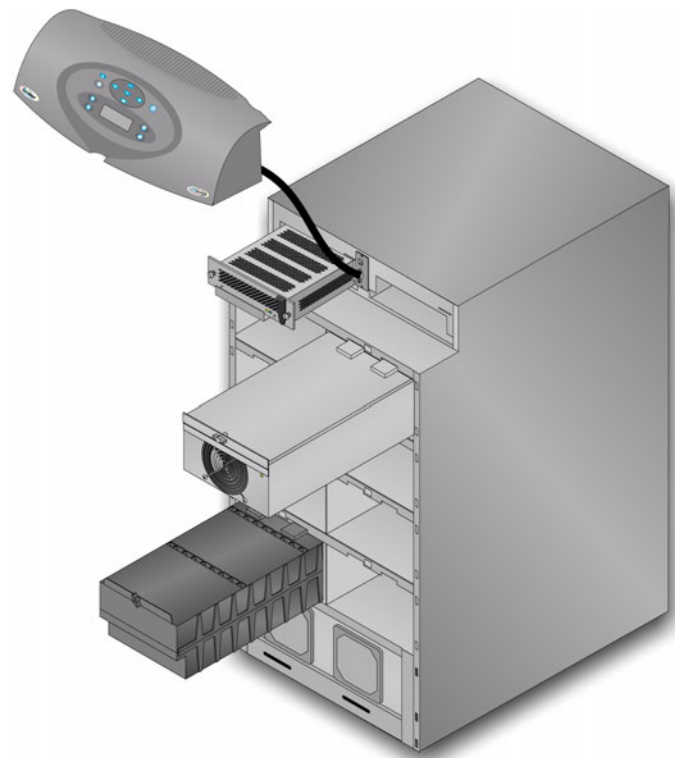

## 5.0 MAINTENANCE

### 5.1 Maintenance

#### 5.1.1 Proper Care

Keeping your Liebert Nfinity UPS operating properly is imperative to optimal performance and life of the unit. It is recommended that a certified technician perform preventive and corrective maintenance. Liebert Global Services (LGS) is dedicated to ensuring the highest level of performance and unmatched support for your Nfinity UPS. Contact an LGS representative for service to guarantee maximum reliability and system availability.

#### 5.1.2 Scheduled Maintenance

It is recommended the following maintenance is performed at least monthly:

- Clean unit
- Clean / replace filters
- Verify proper airflow

It is recommended the following maintenance is performed annually:

- Verify all Power Modules are operating properly.
- Verify all Battery Modules are operating properly.
- Verify redundancy (if applicable).

#### 5.1.3 Replacing Fan Filters

Nfinity's intake fans contain filters that will need to be replaced or cleaned periodically, depending on the surrounding environment. Check by removing the bottom bezel and noting the condition of the two filters. If filters are dirty, replace them by removing the plastic cover over the filter frame and inserting a new filter in its place. Use caution when replacing filters when fans are running.

The fan filters are washable and can be reused. To wash filters, place them under running water (with the dirt side down) to remove dirt and dust. Blot dry with a towel and allow air-drying before reusing.

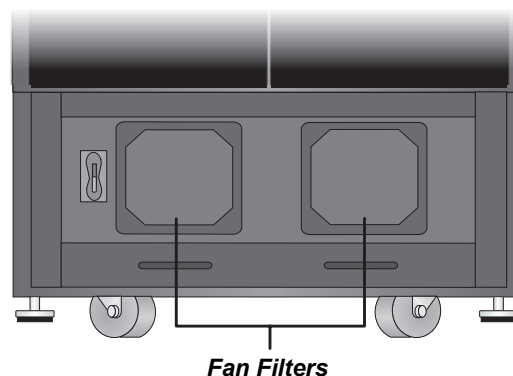



## 6.0 SPECIFICATIONS

General & Environmental		Units	Configuration			
Unit Rating	kVA		4	8	12	16
	kW		2.8	5.6	8.4	11.2
Compliant Safety Standards			UL 1778; c-UL			
Conducted and Radiated EMC Levels			FCC Part 15, Class A			
Compliant Immunity Standards			IEEE C62.41, Category B			
Mechanical		Units	8 Bay		12 Bay	
Dimensions	Width	in (mm)	20 (508)		20 (508)	
	Depth		28 (711)		28 (711)	
	Height		40 (1016)		54 (1372)	
Environmental		Units				
Operating Temperature (max)		F (C)	32° - 104° (0° - 40°)			
Relative Humidity		%	0-95% non-condensing			
Maximum operating altitude		ft. (m)	10,000 (3,000)			
Nominal heat dissipation		BTU/Hr	1,062	2,124	3,186	4,248
Acoustic noise level		dBA	<62 @ 1 meter			
Input Data		Units				
Nominal input voltage		VAC	200 or 210			
Minimum Voltage Range (Typical)		Operating voltage range is variable based on output loading percentages				
			% UPS Load		Input Voltage	
			80 – 100%		170 VAC	
			60 – 80%		144 VAC	
			30 – 60%		127 VAC	
Power factor		Cos Ø	>.98			
Input frequency (nominal)		Hz	50 or 60			
Input frequency range		Hz	40-70			
Battery Module		Units				
Number of lead acid batteries			10			
Number of battery cells			60			
Maximum charge current (full load)		A	3			
Nominal Voltage		VDC	120			
Recharge Time		Hrs	Typically 6 (to 90% capacity)			
Output Data		Units				
Output voltage		VAC	210/105			
Voltage regulation		%	±3			
Voltage stability (100% step load)		%	±7			
Recovery time		msec	96			
Voltage distortion		%	<3 THD, linear load			
			<7 THD, non-linear load			
Output frequency		Hz	60			
Efficiency at 100% load		%	89			
Output overload capability		%	110 - 125% for 10 min			
			126-150% for 10 sec			
			151 - 200% for 2 cycles			

### 6.1 Product Warranty Registration

To register for warranty protection:

- Visit the **Quick Links** section of our Web site at:  
<http://www.liebert.com>
- Click on **Product Warranty Registration** and fill in the form.

If you have any questions, please contact us at:

US: 800-222-5877  
 Outside the US: 614-841-6755  
[upstech@liebert.com](mailto:upstech@liebert.com)





# ***Nfinity***<sup>™</sup> Power System

## **USER MANUAL**

### **The Company Behind the Products**

With over a million installations around the globe, Liebert is the world leader in computer protection systems. Since its founding in 1965, Liebert has developed a complete range of support and protection systems for sensitive electronics:

- Environmental systems—close-control air conditioning from 1 to 60 tons
- Power conditioning and UPS with power ranges from 300 VA to more than 1000 kVA
- Integrated systems that provide both environmental and power protection in a single, flexible package
- Monitoring and control—from systems of any size or location, on-site or remote
- Service and support through more than 100 service centers around the world and a 24/7 Customer Response Center

While every precaution has been taken to ensure the accuracy and completeness of this literature, Liebert Corporation assumes no responsibility and disclaims all liability for damages resulting from use of this information or for any errors or omissions.

© 2003 Liebert Corporation

All rights reserved throughout the world. Specifications subject to change without notice.

® Liebert and the Liebert logo are registered trademarks of Liebert Corporation. All names referred to are trademarks or registered trademarks of their respective owners.

SLI-23950J (8/03) Rev. 0

### **Technical Support/Service**

#### **Web Site**

[www.liebert.com](http://www.liebert.com)

#### **Monitoring**

800-222-5877

[monitoring@liebert.com](mailto:monitoring@liebert.com)

Outside the US: 614-841-6755

#### **Single-Phase UPS**

800-222-5877

[upstech@liebert.com](mailto:upstech@liebert.com)

Outside the US: 614-841-6755

#### **Three-Phase UPS**

800-543-2378

[powertech@liebert.com](mailto:powertech@liebert.com)

#### **Environmental Systems**

800-543-2778

#### **Outside the United States**

614-888-0246

#### **Locations**

##### **United States**

1050 Dearborn Drive

P.O. Box 29186

Columbus, OH 43229

##### **Italy**

Via Leonardo Da Vinci 8

Zona Industriale Tognana

35028 Piove Di Sacco (PD)

+39 049 9719 111

Fax: +39 049 5841 257

##### **Asia**

23F, Allied Kajima Bldg.

138 Gloucester Road

Wanchai

Hong Kong

+852 2 572 2201

Fax: +852 2 831 0114