

HD Camcorder Instruction Manual



NTSC



VIXIA mini



Important Usage Instructions

COPYRIGHT WARNING:

Unauthorized recording of copyrighted materials may infringe on the rights of copyright owners and be contrary to copyright laws.

FCC/IC NOTICE

HD Camcorder, VIXIA mini systems

This device complies with Part 15 of the FCC Rules. Operation is subject to the following two conditions: (1) This device may not cause harmful interference, and (2) this device must accept any interference received, including interference that may cause undesired operation.

Note: This equipment has been tested and found to comply with the limits for class B digital device, pursuant to Part 15 of the FCC Rules. These limits are designed to provide reasonable protection against harmful interference in a residential installation. This equipment generates, uses and can radiate radio frequency energy and, if not installed and use in accordance with the instructions, may cause harmful interference to radio communications. However, there is no guarantee that interference will not occur in a particular installation. If this equipment does cause harmful interference to radio or television reception, which can be determined by turning the equipment off and on, the user is encouraged to try to correct the interference by one or more of the following measures:

- Reorient or relocate the receiving antenna.
- Increase the separation between the equipment and receiver.
- Connect the equipment into an outlet on a circuit different from that to which the receiver is connected.
- Consult the dealer or an experienced radio/TV technician for help.

Use of shielded cable is required to comply with class B limits in Subpart B of Part 15 of FCC Rules. Do not make any changes or modifications to the equipment unless otherwise specified in the manual. If such changes or modifications should be made, you could be required to stop operation of the equipment.

Model ID0032 (including WLAN Module Model RF401, FCC ID: AZD401)

This device complies with Industry Canada license-exempt RSS standard(s). Operation is subject to the following two conditions: (1) this device may not cause interference, and (2) this device must accept any interference, including interference that may cause undesired operation of the device.



This transmitter must not be co-located or operated in conjunction with any other antenna or transmitter.

The available scientific evidence does not show that any health problems are associated with using low-power wireless devices. There is no proof, however, that these low power wireless devices are absolutely safe. Low-power wireless devices emit low levels of radio frequency energy (RF) in the microwave range while being used. Whereas high levels of RF can produce health effects (by heating tissue), exposure to low-level RF that does not produce heating effects causes no known adverse health effects. Many studies of low-level RF exposures have not found any biological effects. Some studies have suggested that some biological effects might occur, but such findings have not been confirmed by additional research. This model has been tested and found to comply with FCC/IC radiation exposure limits set forth for an uncontrolled equipment and meets the FCC radio frequency (RF) Exposure Guidelines in Supplement C to OET65 and RSS-102 of the IC radio frequency (RF) Exposure rules.

Canon U.S.A., Inc.

One Canon Park, Melville, NY 11747, USA

Tel No. 1-800-OK-CANON (1-800-652-2666)

Battery Charger CB-2LV

This power unit is intended to be correctly orientated in a vertical or floor mount position.

IMPORTANT SAFETY INSTRUCTIONS - SAVE THESE INSTRUCTIONS. DANGER - TO REDUCE THE RISK OF FIRE OR ELECTRIC SHOCK, CAREFULLY FOLLOW THESE INSTRUCTIONS.

For connection to a supply not in the U.S.A., use an attachment plug adapter of the proper configuration for the power outlet, if needed.

This battery charger is for exclusive use with Battery Pack NB-4L. There is a danger of explosion if other battery packs are used.

CAUTION

RISK OF EXPLOSION IF BATTERY IS REPLACED BY AN INCORRECT TYPE. DISPOSE OF USED BATTERIES ACCORDING TO LOCAL REGULATION.



REGIONS OF USE

The VIXIA mini is in compliance (as of June 2013) with the radio signal regulations of the regions listed below. For details on other regions where it can be used, make inquiries with the contacts listed at the end of this instruction manual (📖 253).

REGIONS

Canada, Hong Kong S.A.R., South Korea, USA

Model

ID0032: VIXIA mini

Trademark Acknowledgements

- microSD, microSDHC and microSDXC Logos are trademarks of SD-3C, LLC.
- Microsoft and Windows are trademarks or registered trademarks of Microsoft Corporation in the United States and/or other countries.
- App Store, iPad, iPhone, iTunes and Mac OS are trademarks of Apple Inc., registered in the U.S. and other countries.
- HDMI, the HDMI logo and High-Definition Multimedia Interface are trademarks or registered trademarks of HDMI Licensing LLC in the United States and other countries.
- Google, Android, Google Play, YouTube are trademarks of Google Inc.
- Facebook is a registered trademark of Facebook, Inc.
- IOS is a trademark or registered trademark of Cisco in the U.S. and other countries and is used under license.
- The Twitter name and marks are trademarks of Twitter, Inc.
- Wi-Fi is a registered trademark of the Wi-Fi Alliance.
- Wi-Fi Certified, WPA, WPA2, and the Wi-Fi Certified logo are trademarks of the Wi-Fi Alliance.
- WPS as used on the camcorder's settings, onscreen displays and in this manual signifies Wi-Fi Protected Setup.
- The Wi-Fi Protected Setup Identifier Mark is a mark of the Wi-Fi Alliance.
- Other names and products not mentioned above may be trademarks or registered trademarks of their respective companies.
- This device incorporates exFAT technology licensed from Microsoft.
- "Full HD 1080" refers to Canon camcorders compliant with high-definition video composed of 1,080 vertical pixels (scanning lines).

FULL HD
1080



- This product is licensed under AT&T patents for the MPEG-4 standard and may be used for encoding MPEG-4 compliant video and/or decoding MPEG-4 compliant video that was encoded only (1) for a personal and non-commercial purpose or (2) by a video provider licensed under the AT&T patents to provide MPEG-4 compliant video. No license is granted or implied for any other use for MPEG-4 standard.

Copyright







- If you use copyrighted songs and music tracks in your video creations, remember that music under copyright may not be used without permission from the copyright holder, except for cases permitted under applicable laws, such as for personal use. Make sure to follow applicable laws when using music files.





About this Manual

Thank you for purchasing the Canon VIXIA mini. Please read this manual carefully before you use the camcorder and retain it for future reference. Should your camcorder fail to operate correctly, refer to **Troubleshooting** ( 199).

Conventions Used in this Manual

-  Important precautions related to the camcorder's operation.
-  Additional notes and topics that complement the basic operating procedures.
-  Restrictions, requirements or preconditions regarding the function described.
-  Reference page number within this manual.
-  This arrow is used to abbreviate menu selections. For a detailed explanation on how to use the menus, refer to **Using the Menus** ( 45).

- “Scene” refers to one movie unit from the point you touch [] to start recording until you touch [] to stop recording.
- Brackets [] are used to refer to onscreen controls you need to touch (menus, buttons, etc.) and to messages as they are displayed on the screen.



- The photos included in this manual are simulated pictures taken with a still camera.
- Illustrations of the camcorder's screen or a computer's screen included in this manual may show only relevant parts of the screen.
- **Navigation buttons:** The navigation bar at the bottom of the page offers up to four buttons to let you get quickly to the information you want to find.



Jump to the general table of contents.



Go to a list of select functions grouped by their uses in real-life situations. This alternative index can be very useful for beginners who encounter a particular challenge but are not sure of what function to use.



Jump to the alphabetical index.



The button with a number in it will take you to the beginning of the current chapter, where you will find an overview of the information and related functions covered in that chapter. Note that the icon itself will change depending on the chapter you are currently reading.





Table of Contents

Important Usage Instructions.....	2
About this Manual	6
The Camcorder's Functions in Real-Life Situations	13
Unique functions for special cases	13
Getting the look you want.....	14
Challenging subjects and shooting conditions	15
Audio, playback, editing and others.....	15
Wireless functions	17
Getting to Know the Camcorder	19
Supplied Accessories and CD-ROM.....	19
Names of Parts	21
Preparations	27
Charging and Inserting the Battery Pack.....	29
Using a Memory Card	34
Memory Cards Compatible for Use with the Camcorder.....	34

Inserting and Removing a Memory Card.....	36
First Time Settings	38
Basic Setup	38
Changing the Time Zone	41
Initializing a Memory Card.....	42
Basic Operation of the Camcorder	44
Using the Touch Screen.....	44
Using the Menus	45
Operating Modes	51
Basic Recording and Playback	53
Basic Recording.....	54
Recording Video.....	54
Changing the Field of View	57
Taking Photos	61
Basic Playback.....	65
Playing Back Video	65
Viewing Photos	72
Deleting Scenes	76
Trimming Scenes	79
Deleting Photos.....	81
Slideshow	84

Advanced Functions	85
Video Quality and Shooting Modes	87
Selecting the Video Quality	87
Selecting the Photo Size	89
Selecting the Shooting Mode	90
Special Recording Modes.....	94
Interval Recording	94
Slow and Fast Motion.....	98
Video Snapshot.....	100
Convenient Functions	102
Self Timer.....	102
Decoration: Adding a Personal Touch	103
Image Rotation and Image Flipping	108
Audio Scenes.....	110
When You Want More Control	112
White Balance	112
Exposure.....	114
Face Detection	117
Capturing Video Snapshot Scenes and Photos from a Movie	120

External Connections.....	123
Terminals on the Camcorder	124
Connection Diagrams.....	125
Playback on a TV Screen	127
Saving and Sharing Your Recordings.....	128
Converting and Resizing Movies.....	128
Saving Recordings on a Computer.....	131
Uploading Recordings to the Web.....	137
Wi-Fi Functions	138
The Camcorder's Wi-Fi Functions	140
Wireless Connections Without an Access Point.....	145
Using an iOS or Android Device as a Remote Control.....	145
Remote Browse: Viewing Recordings Using a Web Browser on an iOS or Android Device	148
Saving Recordings and Uploading Movies to the Web Using an iOS Device	151
Wireless Connections Using an Access Point.....	154
Sharing Recordings with CANON iMAGE GATEWAY	154
Wireless Playback on a Computer.....	161
Wi-Fi Connection Using an Access Point.....	163
Viewing and Changing Wi-Fi Settings	173

Additional Information	176
Appendix: Menu Options Lists.....	178
[ Other Settings] Menus	180
Appendix: Onscreen Icons and Displays	192
Trouble?	199
Troubleshooting	199
List of Messages	210
Do's and Don'ts	226
Handling Precautions	226
Maintenance/Others.....	232
Cleaning.....	232
Condensation.....	233
Using the Camcorder Abroad.....	234
General Information	235
Optional Accessories.....	235
Specifications.....	239
Index	245



The Camcorder's Functions in Real-Life Situations

Unique functions for special cases

Record a mirror image of your dance training so you can practice along with the playback scene.

- ▶ Automatic Image Rotation and Image Flipping (📖 108)



Shoot a cool time-lapse video or use slow motion to check your golf swing.

- ▶ Interval Recording (📖 94)
- ▶ Slow and Fast Motion Recording (📖 98)

Decorate movies with graphics and stamps.

- ▶ Decoration (📖 103)



Create a dynamic montage sequence with short cuts.

▶ Video Snapshot (📖 100)

Getting the look you want

Get gorgeous video and photos without bothering with settings.

▶ **AUTO** mode (📖 54)

Make the image brighter or darker than the exposure set by the camcorder.

▶ Exposure (📖 114)

Change how smooth or natural movement looks in your videos.

▶ Frame Rate (📖 182)

Create a copy of your movies applying a unique cinematic filter.

▶ Converting and Resizing Movies (📖 128)

Change the field of view you record from a fisheye-like ultra wide angle to a close-up center view.

▶ Field of View (📖 57)



Cinema filter
[FILTER 2] (Vivid)



Challenging subjects and shooting conditions

Shoot great video of special scene situations with minimal settings.

▶ Shooting Modes (📖 90)

Obtain natural-looking colors even under special lighting conditions.

▶ White Balance (📖 112)



Optimize the exposure for the desired subject just by touching the screen.

▶ Touch AE (📖 116)

Keep the exposure optimized while shooting a moving subject.

▶ Face Detection and Tracking (📖 117)

Give yourself time to get in the picture.

▶ Self Timer (📖 102)

Audio, playback, editing and others

Record the best sound possible according to your shooting situation.

▶ Audio Scenes (📖 110)



Save parts of your video as photos or short video snapshot scenes.

▶ Capturing Photos/Video Snapshot Scenes (📖 120)

Convert your scenes into a smaller file size to upload to the Web.

▶ Converting and Resizing Movies (📖 128)

Play a slideshow of your photos.

▶ Slideshow (📖 84)

Enjoy your recordings on a TV.

▶ HDMI Connection (📖 125)

▶ Playback (📖 127)

Save recordings on your computer and upload them to the Web.

▶ Saving Recordings (ImageBrowser EX) (📖 131)

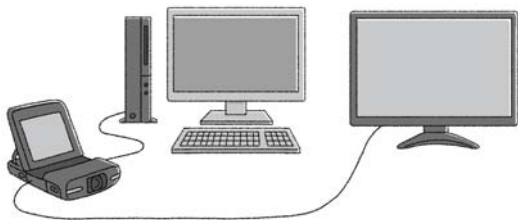

Wireless functions

Use your smartphone or tablet as a remote control while recording.

▶ Wi-Fi Remote Control (CameraAccess) (📖 145)

Use a Web browser on your smartphone or tablet to access and play back the recordings in the camcorder.

▶ Remote Browse/Playback via Browser (📖 148)

Use an iOS app to wirelessly transfer recordings to your iPhone/iPad and upload them to the Web.

▶ Movie Uploader (📖 151)



Share your recordings with Web albums using CANON iIMAGE GATEWAY.

- ▶ CANON iIMAGE GATEWAY (📖 154)

Connect the camcorder to your home network and wirelessly stream your recordings.

- ▶ Media Server (📖 161)
- ▶ Wi-Fi Connection to an Access Point (📖 163)

Review and change Wi-Fi settings (for advanced users).

- ▶ Wi-Fi Settings (📖 173)
-

Supplied Accessories and CD-ROM

The following accessories are supplied with the camcorder:

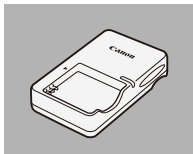

▶ CB-2LV Battery Charger*

NB-4L Battery Pack ◀

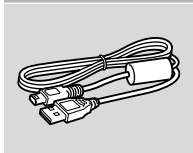
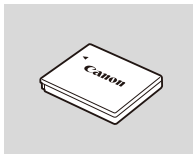

▶ IFC-400PCU USB Cable

WS-DC11 Wrist Strap ◀

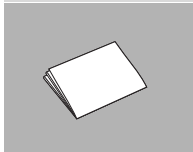
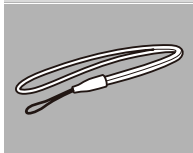

▶ Getting Started Leaflet

Canon VIXIA mini CD-ROM ◀

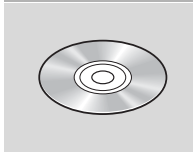

* CB-2LVE including power cord, in Asia.



The **Canon VIXIA mini CD-ROM** contains the following components:

- Instruction Manual - The full-version instruction manual of the camcorder (this PDF file).
 - ImageBrowser EX - The CD-ROM contains an automatic installer for the software **ImageBrowser EX**, which allows you to save and manage movies and photos and upload them to CANON iMAGE GATEWAY*, YouTube and Facebook. An Internet connection is required for full installation of the software.
- * CANON iMAGE GATEWAY is an online service that allows you to share movies and photos, make photo albums, and more. This service may not be available in all countries/regions.



Names of Parts

Left side view

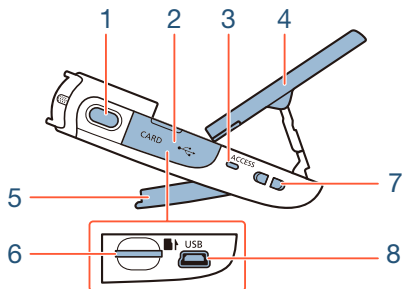

- 1 Photo button (📖 61)
- 2 Memory card slot cover (📖 36)
- 3 ACCESS indicator (📖 54, 61)
- 4 LCD panel (📖 25)
- 5 Adjustable stand (📖 25)
- 6 Memory card slot (📖 36)
- 7 Strap mount (📖 25)
- 8 USB terminal (📖 124, 126)



Right side view

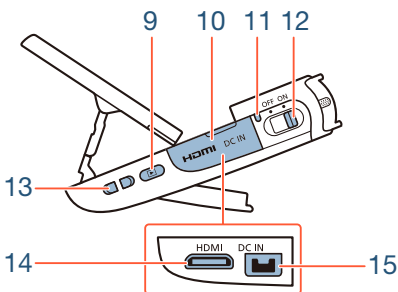

9 ▶ (playback mode) button (📖 65, 70)

10 Terminal cover

11 Power indicator

12 Power switch (ON/OFF) (📖 54, 61)

13 Strap mount (📖 25)

14 HDMI terminal (📖 124, 125)

15 DC IN terminal

To use the optional CA-110 Compact Power Adapter.



Front view

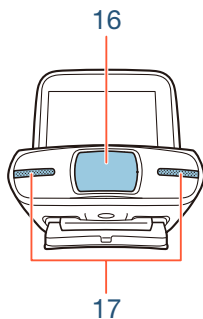

Top view

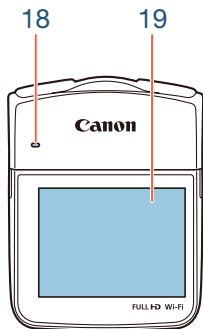

16 Lens cover

17 Stereo microphone (📖 110)

18 Speaker (📖 67)

19 LCD touch screen (📖 26, 44)



Bottom view

Back view

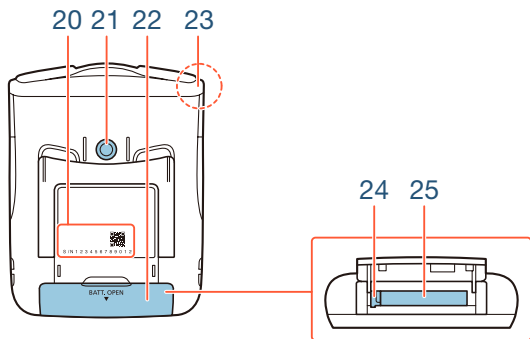

20 Serial number



21 Tripod socket (📖 228)

22 Battery compartment cover (📖 30)

23 Wi-Fi antenna (📖 138)

24 Battery release latch (📖 30)

25 Battery compartment (📖 30)



Adjusting the camcorder's position

The camcorder has an adjustable stand (5) and an articulated LCD panel (4) that allow you to easily adjust its position to match your recording conditions.

Here are typical shooting positions (all degree measurements are approximate):

1

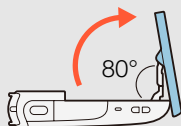

2

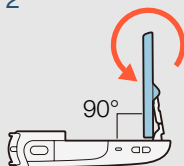

3

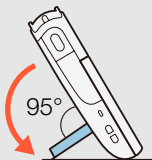
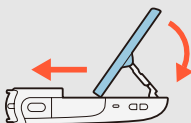



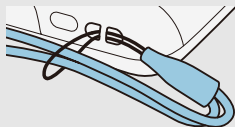

13 Strap mount

You can attach the supplied wrist strap to one side of the camcorder.



19 LCD touch screen

- The screen is produced using extremely high-precision manufacturing techniques, with more than 99.99% of the pixels operating to specification. Less than 0.01% of the pixels may occasionally misfire or appear as black, red, blue or green dots. This has no effect on the recorded image and does not constitute a malfunction.
- For details about how to take care of the touch screen, refer to **Handling Precautions** (📖 226), **Cleaning** (📖 232).
- You can adjust the screen's brightness using the  
  [LCD Brightness] and [LCD Backlight] settings.





Preparations

29

Charging and Inserting the Battery Pack

The first step for using your camcorder is to prepare the power supply. This section explains how to charge a battery pack and how to install it in the camcorder.

34

Using a Memory Card

Next, you need to prepare a memory card where your movies and photos will be recorded. This section explains the types of memory cards that can be used and how to insert one into the camcorder.

38

First Time Settings

Now that your camcorder is powered up and has a memory card, you can turn it on and complete the basic setup. These include selecting the camcorder's language and setting the date and time.



Basic Operation of the Camcorder

In this section you can learn more about basic operations, such as using the touch screen, changing operating modes and using the menu.



Charging and Inserting the Battery Pack

Charge the supplied battery pack in advance, using the supplied battery charger.

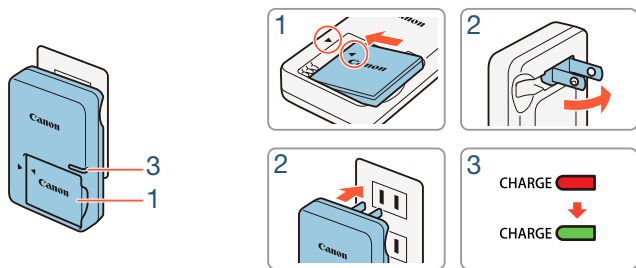

■ Charging the Battery Pack

- 1** Attach the battery pack to the battery charger, aligning the triangle marks.
- 2** Extract the fold-in plug and plug the battery charger into a power outlet.
 - For Asia only: Connect the power cord to the battery charger and plug the other end into a power outlet.



Charging and Inserting the Battery Pack

- When the CHARGE indicator on the battery charger turns green, the battery pack is fully charged.

- 3** When the battery pack is fully charged, remove the battery pack from the battery charger and unplug the battery charger.

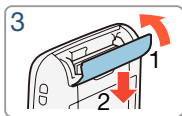
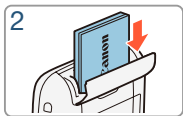
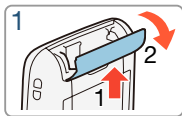
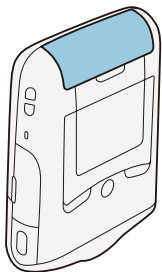

■ Inserting the Battery Pack

- 1** Push the battery compartment cover in the direction of the arrow to open it.
- 2** Insert the battery pack with the Canon label facing the bottom of the camcorder.
 - Push the battery pack all the way in, until the battery release latch secures it in place.



3 Close the battery compartment cover.

- Push the cover until you hear a click. Do not force the cover closed if the battery pack is not correctly inserted.

To remove the battery pack

Open the battery compartment cover and slide the battery release latch in the direction of the arrow so the battery pack springs out. Remove the battery pack and close the cover.

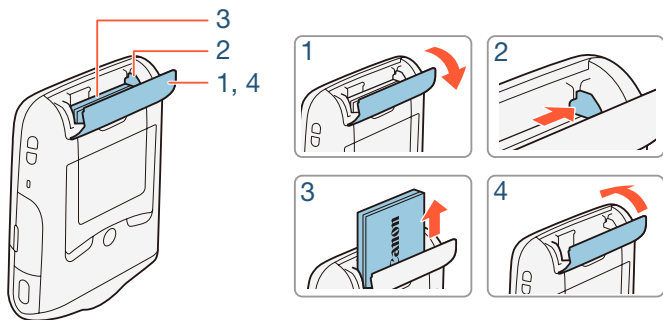

- Turn off the camcorder before removing the battery pack. After turning off the camcorder, important data is updated on the memory card. Be sure to wait until the green power indicator goes out.





- Do not connect to the camcorder's DC IN terminal any electrical equipment that is not expressly recommended for use with this camcorder.
- To prevent equipment breakdowns and excessive heating, do not connect the supplied battery charger to voltage converters for overseas travels or special power sources such as those on aircraft and ships, DC-AC inverters, etc.



- Fully charging a battery pack will take approximately 1 hour 30 minutes. (The actual charging time will vary depending on charging conditions and the initial charge of the battery pack.)
- If remaining battery time is an issue, you can power the camcorder using the optional CA-110 Compact Power Adapter. Battery packs cannot be charged by the camcorder even when the optional compact power adapter is used.
- For approximate recording/playback times with a fully charged battery pack, refer to **Approximate Usage Times** (📖 237).
- Charged battery packs continue to discharge naturally. Therefore, charge them on the day of use, or the day before, to ensure a full charge.





- **USA and Canada only:**

The Lithium ion/polymer battery that powers the product is recyclable. Please call 1-800-8-BATTERY for information on how to recycle this battery.



Using a Memory Card

Memory Cards Compatible for Use with the Camcorder

You can use the following types of commercially available microSD cards with this camcorder. We recommend using memory cards rated SD Speed Class 10.

As of June 2013, the movie recording function has been tested using microSD/microSDHC/microSDXC cards made by Panasonic, Toshiba and SanDisk. For the latest information on memory cards that can be used, visit your local Canon Web site.

Memory card type:  microSD card

 microSDHC card

 microSDXC card

SD Speed Class*: CLASS②** CLASS④** CLASS⑥** CLASS⑩

Capacity: 128 MB or larger***

* When using a microSD card without a speed class rating, you may not be able to record movies, depending on the memory card used.

** When using microSD cards with this SD Speed Class rating, we recommend recording movies only at a video quality of 4 Mbps.

***microSD cards with a capacity of 64 MB or smaller cannot be used to record movies.





- After repeatedly recording, deleting and editing scenes (fragmented memory), it will take longer to write data on the memory card and recording may stop. Save your recordings and initialize the memory card using the [Complete Initialization] option.



- **About the Speed Class:** Speed Class is a standard that indicates the minimum guaranteed data transfer speed of memory cards. When you buy a new memory card, look for the Speed Class logo on the package.

■ microSDXC Cards

You can use microSDXC cards with this camcorder. When using microSDXC cards with other devices, such as digital recorders, computers and card readers, **make sure that the external device is compatible with microSDXC cards.** For more information on compatibility, contact the computer, operating system or memory card manufacturer.



- If you use a microSDXC card with a computer OS that is not SDXC-compatible, you may be prompted to format the memory card. In such case, **cancel the operation to prevent data loss.**



Inserting and Removing a Memory Card

Make sure to initialize all memory cards with the camcorder, using the [Complete Initialization] option, before using them for the first time. When you turn on the camcorder for the first time, you will need to complete the basic setup first (📖 38), and then initialize the memory card (📖 42).

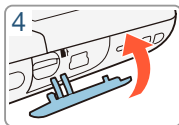
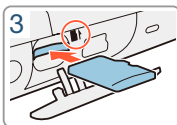
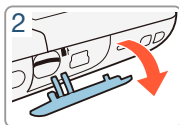
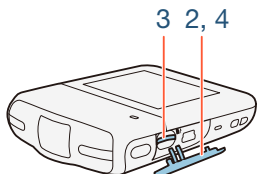
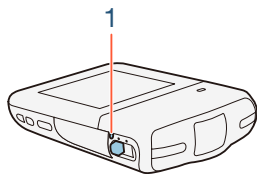

1 Turn off the camcorder.

- Set the power switch to OFF and check that the power indicator is off.

2 Open the memory card slot cover.

3 Insert the memory card with the label facing up and push it all the way into the memory card slot until it clicks.



4 Close the memory card slot cover.

- Do not force the cover closed if the memory card is not correctly inserted.

To remove the memory card

Push the memory card once to release it. When the memory card springs out, pull it all the way out.



- Memory cards have front and back sides that are not interchangeable. Inserting a memory card facing the wrong direction can cause a malfunction of the camcorder. Be sure to insert the memory card as described in step 3.



First Time Settings

Basic Setup

The first time you turn on the camcorder, you will be guided by the camcorder's basic setup screens to select the camcorder's language and set the date and time. For details on how to use the touch screen, refer to **Using the Touch Screen** (📖 44).

- 1** Set the power switch to ON to turn on the camcorder.
 - The lens cover will open.

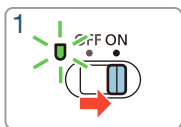
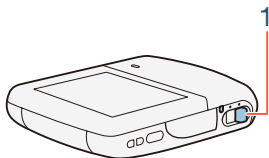

- The language selection screen will appear.
- 2** Touch the language that you want to be used for onscreen displays and then touch [▷].
 - You can select one of 27 languages. You may need to scroll down to find your language.
 - After you select a language, the [Date Format] screen will appear.





Touch [▷] after selecting a language

- 3 Touch [Y.M.D], [M.D,Y] or [D.M.Y] to select the date format you prefer and then touch [▷].
 - After you select the date format, the [Date/Time] screen will appear with the first field selected.
- 4 Touch a field you want to change (year, month, day, hours or minutes).
- 5 Touch [▲] or [▼] to change the field as necessary.

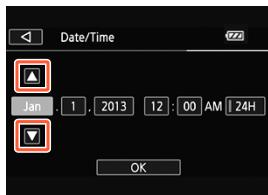











6 Set the correct date and time by changing all the fields in the same way.

- Touch [24H] to use 24-hour clock or leave it unselected to use 12-hour clock (AM/PM).

7 Touch [OK] to complete the basic setup and close the setup screen.



- Some buttons, such as [ON]/[OFF] in some screens, will appear in English regardless of the language selected.
- You can change the language and adjust the date and time later on, using the following menu settings.
 -     [Language 
 -     [Date/Time]
- When you do not use the camcorder for about 3 weeks, the built-in rechargeable lithium battery may discharge completely and the date and time setting may be lost. In such case, recharge the built-in lithium battery ( 231). The next time you turn on the camcorder, you will have to perform the basic setup again.



Changing the Time Zone

Change the time zone to match your location. The default setting is New York. In addition, the camcorder is able to retain the date and time of another location. This is convenient when you travel so that you can set the camcorder to match the time of your home location or that of your destination.

This section requires using the camcorder's menus. For details about how to use the menus, refer to **Using the Menus** (📖 45).



- 1 Open the [Time Zone/DST] screen.



- 2 Touch [] to set the home time zone, or [] to set the time zone of your destination when you are traveling.
- 3 Touch [] or [] to set the desired time zone. If necessary, touch [] to adjust for daylight saving time.
- 4 Touch [] to close the menu.



Initializing a Memory Card

Initialize memory cards when you use them with this camcorder for the first time. You can also initialize a memory card to permanently delete all the recordings it contains.

Shooting mode

AUTO



P

Playback





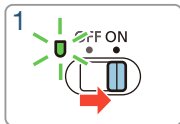
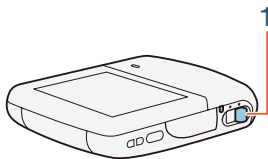

- 1** Make sure the camcorder has sufficient power to complete the operation.
 - Insert a fully charged battery pack or use the optional CA-110 Compact Power Adapter.
- 2** Set the power switch to ON to turn on the camcorder.
 - The lens cover will open.



- 3** Initialize the memory card.



 >  Other Settings >  > [Initialize > [Initialize] > [Complete Initialization]¹ > [Yes]² > [OK] > [X]

- ¹ Touch this option if you want to physically erase all the data rather than just clear the file allocation table of the memory card.
- ² If you selected the [Complete Initialization] option, you can touch [Cancel] to cancel the initialization while it is in progress. All recordings will be erased and the memory card can be used without any problem.



- Initializing a memory card will permanently erase all recordings. Lost original recordings cannot be recovered. Make sure you save important recordings in advance ( 131).



Basic Operation of the Camcorder

Using the Touch Screen

The buttons and menu items that appear on the touch screen change dynamically depending on the operating mode and the task you are performing. With the intuitive touch screen interface you have all the controls at your fingertips.

1

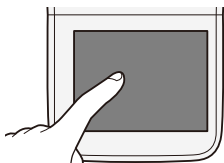

2

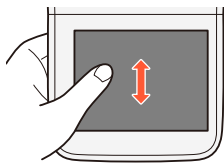

1 Touch

Touch on an element displayed on the touch screen.

Used to start playing back a scene in an index screen, to select a setting from the menus, etc.

2 Drag

While touching the screen, swipe your finger up and down or left and right across the screen.





Used to scroll menus, to browse through index screen pages or to adjust slider controls like the volume.





- In the following cases, you may not be able to perform touch operations correctly.
 - Using your fingernails or hard-tipped objects, such as ballpoint pens.
 - Operating the touch screen with wet or gloved hands.
 - Applying excessive force with your finger.

Using the Menus

The  (Home) menu is the gateway to most of the camcorder's functions and settings. In recording mode, the  (Home) menu offers immediate access to some frequently used functions. In playback mode, it is from the  (Home) menu that you will switch between the movies' and photos' index screens. In both modes, from the  (Home) menu you can open the [ Other Settings] menus for more detailed settings, and also access the camcorder's various Wi-Fi functions.



■ 🏠 (Home) Menu



Recording mode



Playback mode

- 1** Touch [🏠] on the bottom left corner (recording mode) or top left corner (playback mode) of the screen to open the 🏠 (Home) menu.
- 2** Drag your finger left/right to bring the desired menu to the center.
- 3** Touch the icon of the desired menu to open it.
 - See the following table for a description of each menu.



Menu item

Description

 Other Settings] (📖 50, 180)

Opens the [ Other Settings] menus, which give you access to various camcorder settings.

[Audio Scene]* (recording mode only) (📖 110)

Optimize audio settings for your surroundings to get the best possible sound.

[Special Rec Modes]* (recording mode only) (📖 94)

Enjoy special recording modes, like slow and fast motion and interval recording, to achieve unique effects.

[Shooting Mode]* (recording mode only) (📖 90)

The camcorder features a number of shooting modes that offer the most appropriate settings for a variety of special scenes.

 Flip/Rotate Image] (recording mode only) (📖 108)

You can have the camcorder record a mirror image (flipped horizontally) or automatically detect its position to rotate the image during playback.

* For these menu items, the icon shown in the  (Home) menu indicates, respectively, the shooting mode, special recording mode or audio scene currently selected.



Menu item

Description

[🕒 Self Timer] (recording mode only) (📖 102)

Convenient function to give you time to get in the picture after setting up the camcorder.

[📱 Remote Control+Streaming] (recording mode only) (📖 145)

Use your smartphone or tablet as a remote control to record with the camcorder. You can also stream video from the camcorder and record it on the smartphone or tablet.

[📷 Photo Playback] (playback mode only) (📖 72)

Switches the camcorder to photo playback mode and opens the [📷] index screen.

[🎬 Movie Playback] (playback mode only) (📖 65)

Switches the camcorder to movie playback mode and opens the [🎬] index screen.

[🎞️ Video Snapshot] (playback mode only) (📖 65)

Switches the camcorder to movie playback mode and opens the [🎞️] index screen, which displays only your video snapshot scenes.



Menu item

Description

[] Wi-Fi] (playback mode only) (138)

Allows you to access the various Wi-Fi functions, such as uploading recordings to the Web or playing back recordings using a smartphone.

■ Using the Menus

Changing the camcorder's various settings using the menu is very easy. You make your selection simply by touching the button of the desired option. When they appear on the screen, you can touch [] to return to the previous screen or [] to close the menu.

In some screens, you will need to scroll to find the desired option.

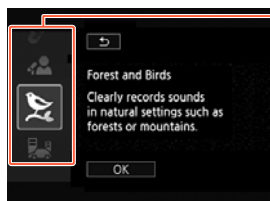

Some screens provide additional information about the options. In that case, simply drag your finger up and down along the column of icons.



The [⚙️ Other Settings] Menu

The [⚙️ Other Settings] menus offer many options to control various aspects of the camcorder's operation. For details, refer to the complete list of settings in the appendix [⚙️ Other Settings] Menus (📖 180).

In the [⚙️ Other Settings] menus, settings are organized under submenus (tabs). For brevity's sake, these settings are referenced throughout the manual like this: “[⚙️] ➡ [👉] ➡ [Language 🗣️]”. In this example (to change the language), you will need to do the following:

- 1 Touch [🏠] to open the 🏠 (Home) menu.
- 2 Drag your finger left/right to bring [⚙️ Other Settings] to the center. Then, touch the icon to open the [⚙️ Other Settings] menus.

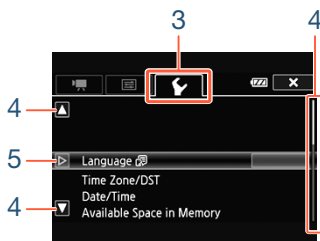
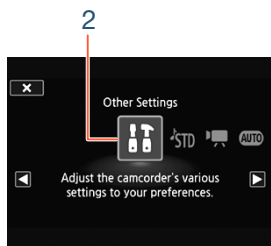

- 3 Touch the tab of the desired menu.
- 4 Drag your finger up/down to bring the setting you want to change into the orange selection bar.
 - You can also use the [▲] and [▼] icons for scrolling.
 - Menu items not available appear grayed out.
 - You can touch any menu item on the screen to bring it directly into the selection bar.
- 5 When the desired menu item is inside the selection bar, touch [▷].
- 6 Touch the desired option and touch [✕].
 - You can touch [✕] to close the menu at any time.

Operating Modes

In this manual, the camcorder's operating modes are indicated with a bar of icons. A full icon in blue (**AUTO**) indicates that the function described can be used in that particular operating mode; a grayed-out icon () indicates the function is not available in that operating mode. Icons are divided into recording and playback modes.







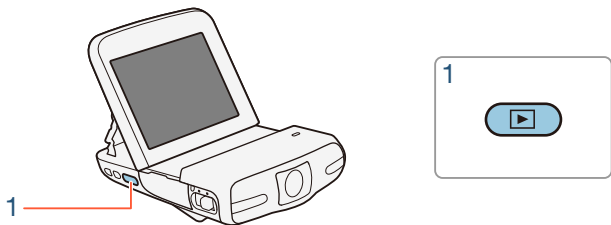

■ Recording

When you set the power switch to ON, the camcorder will turn on in recording mode. In recording mode, the camcorder's operating mode is determined by the selected shooting mode (📖 90). The shooting mode icons are the same icons used in the shooting mode selection screen.

■ Playback



Press the  button to switch the camcorder between recording mode and playback mode.

In the bar of operating mode icons, the  icon refers to playing back movies, whether from the [] index screen (all scenes) or from the [] index screen (only video snapshot scenes) (📖 65). The  icon refers to viewing photos from the [] index screen (📖 72).





Basic Recording and Playback

Basic Recording

54

This section covers how to easily record video and photos in **AUTO** mode. To record using other shooting modes, use more advanced functions and enjoy full access to all menu settings, refer to **Advanced Functions** (📖 85).

Basic Playback

65

This section covers how to play back, trim and delete movies and how to view photos (including in slideshow mode) and delete them.

Basic Recording

Recording Video

With **AUTO** mode, you can take great-looking videos by letting the camcorder automatically adjust settings. **AUTO** mode is therefore used as an example in the following procedure. You can select a different shooting mode according to the shooting conditions (📖 90).



- **Before you begin recording,** make a test recording first to check that the camcorder is operating correctly.

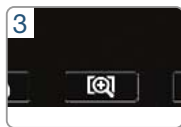
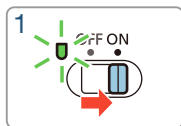
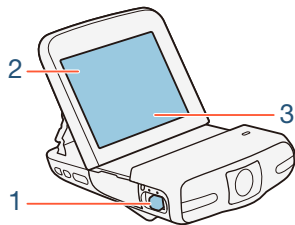

Shooting mode button



- 1** Set the power switch to ON to turn on the camcorder.
 - The lens cover will open.
 - Place and adjust the camcorder as necessary. If shooting with the camcorder hand-held, be careful not to obstruct the lens.
- 2** Set the camcorder to **AUTO** mode.

Touch the shooting mode button ➤ [**AUTO** Auto] ➤ [OK]

- This step is not necessary the first time you use the camcorder.
- 3** If necessary, change the field of view (ultra wide or close-up).
 - Refer to **Changing the Field of View** (📖 57). The default field of view is ultra wide angle.



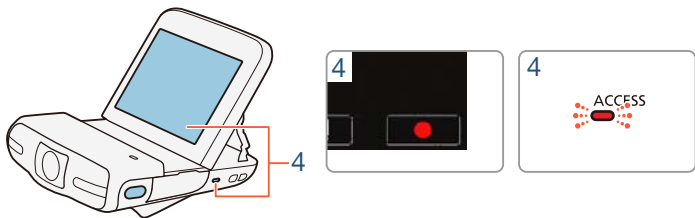

4 Touch [●] to begin recording.

- Movies have an aspect ratio of 16:9. When the recording starts, the onscreen display will change to letterbox mode.
- The ACCESS indicator will flash from time to time while the scene is being recorded.

5 Touch [■] to stop recording.

When you have finished recording

Make sure the ACCESS indicator is off and set the power switch to OFF.



■ Changing the Field of View

The camcorder features a ultra wide angle lens so you can capture a vast field of view (about 160° for video, about 170° for photos), for example to include a large group in a fisheye-like image. Alternatively, you can enlarge the center of the screen for a closer view.

Touch **[⊕]** to enlarge the center of the screen (close-up).

Touch **[⊖]** to return to the default field of view (ultra wide).

[⊖] (ultra wide)



[⊕] (close up)



About AUTO mode

- Only the following functions are available in **AUTO** mode.
 - Video snapshot (📖 100).
 - Face detection and tracking (📖 117) to get the best exposure when a person's face is detected.
 - Decoration (📖 103) to add a fun personal touch using stamps and drawings.









About the Smart AUTO function

In **AUTO** mode, the camcorder will automatically detect certain characteristics of the subject, background, lighting conditions, etc.* It will then adjust the exposure and color, selecting the best settings for the scene you want to shoot. The icon in the shooting mode button will automatically change to one of the following Smart AUTO icons.





- * Under certain conditions, the Smart AUTO icon that appears on the screen may not match the actual scene. Especially when shooting against orange or blue backgrounds, the Sunset or one of the Blue Skies icons may appear and the colors may not look natural. In such case, we recommend recording in **P** mode (📖 90).



Smart AUTO icons

Subject	Background		
	Bright*	Blue skies*	Vivid colors*
People (stationary)			
People (moving)			
Subjects other than people, such as landscapes			

* The icon in parentheses appears under backlight conditions.



Subject	Background		
	Sunset	Dark	Dark + Spotlight
People (stationary)	—		—
People (moving)	—		—
Subjects other than people, such as landscapes			









- In order to protect the lens, turn off the camcorder after you have finished recording to keep the lens cover closed.





- Observe the following precautions while the ACCESS indicator is on or flashing. Failing to do so may result in permanent data loss or damage to the memory card.
 - Do not remove the memory card.
 - Do not disconnect the power source or turn off the camcorder.
 - Do not press the  button.
- Be sure to save your recordings regularly ( 131), especially after making important recordings. Canon shall not be liable for any loss or corruption of data.



- If a subject is too close to the camcorder, it may not be able to focus correctly. You can set the shooting mode to  ( 90) to be able to focus a subject at a distance of only 20 cm (7.9 in.) from the camcorder.
- If     [Auto Power Off] is set to [**ON** On], the camcorder will shut off automatically to save power when it is powered by a battery pack and is left without any operation for 3 minutes. Should this happen, set the power switch to OFF and then ON again to turn the camcorder back on.





- When recording in bright places, it may be difficult to use the LCD screen. In such cases, you can adjust the LCD backlight with the [LCD Backlight] setting or adjust the brightness of the LCD screen with the [LCD Brightness] setting.
- In order to save power, the image shown on the screen in record standby mode is less detailed than the image that will actually be recorded.
- Using the optional SP-V1 Splashproof Case is recommended to operate the camcorder with wet hands, for example when recording in the kitchen. Available functions and operations are limited when the camcorder is protected by the splashproof case.

Taking Photos

You can easily take photos with the camcorder. In the following procedure, **AUTO** mode is used as an example but you can select a different shooting mode according to the shooting conditions (📖 90).

Shooting mode

AUTO



P



Playback



1 Set the power switch to ON to turn on the camcorder.

- The lens cover will open.
- Place and adjust the camcorder as necessary. If shooting with the camcorder hand-held, be careful not to obstruct the lens.

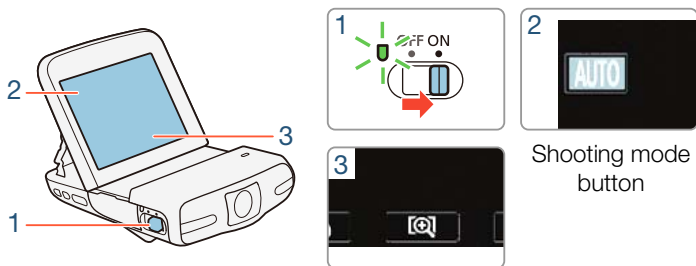

2 Set the camcorder to **AUTO** mode.

Touch the shooting mode button ➤ [**AUTO** Auto] ➤ [OK]

- This step is not necessary the first time you use the camcorder.

3 If necessary, change the field of view and photo size.

- Refer to **Changing the Field of View** (📖 57) and **Selecting the Photo Size** (📖 89).



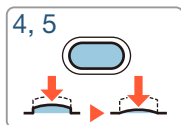
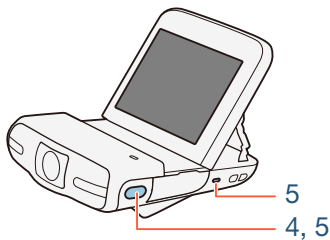

4 Press the photo button halfway to lock the exposure.

- The camcorder will beep and automatically adjust the exposure.
-  and the aperture value and shutter speed will appear on the screen.

5 Press the photo button fully to take a photo.



- You will hear the shutter release and another beep. The ACCESS indicator will also flash as the photo is recorded.
- Photos have an aspect ratio of 4:3.

When you have finished taking photos

Make sure the ACCESS indicator is off and set the power switch to OFF.





The information in the sidebars,  (important precautions) and  (additional notes) sections in the previous pages ( 58-61) apply also to photo shooting.



- Photos can only be recorded in record standby mode.



Basic Playback

Playing Back Video

Shooting mode



Playback

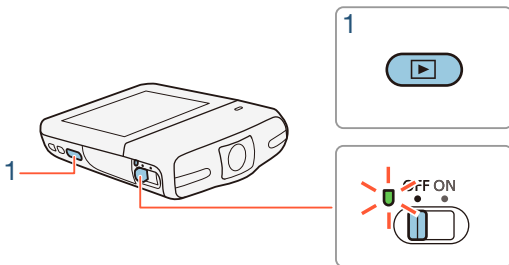

1 Press the button to turn on the camcorder in playback mode.

- The index screen will appear.
- To play back only video snapshot scenes, touch to open the index screen.



Visual bar shows the relative location of the current index screen.



Folder name. The last four digits represent the recording date (1103 = 3 November).

2 Look for the scene you want to play back.

- Drag your finger right/left (2a) or touch [◀] or [▶] (2b) to display the previous/next index screen.

3 Touch the desired scene to play it back.

- The camcorder will play back the scene selected and continue until the end of the last scene in the index screen.
- Touch the screen to display the playback controls. During playback, the playback controls will disappear automatically after a few seconds without operation.



To adjust the volume

- 1 During playback, touch the screen to display the playback controls.
- 2 Touch [🔊], drag your finger along the [Speaker Volume] bar, or repeatedly touch the speaker icon on either end of it, to adjust the volume and touch [↶].

Playback controls

Playback

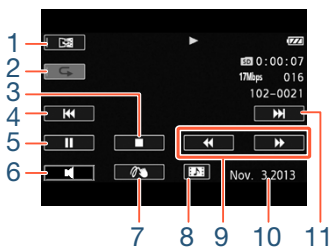

Playback pause

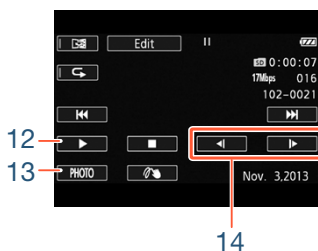

- 1 Mirror image playback.
- 2 Repeat playback.
- 3 Stop the playback.
- 4 Jump to the beginning of the scene. Double-tap to jump to the previous scene.
- 5 Pause the playback.



- 6 Volume control.
 - 7 Decoration (📖 103).
 - 8 Capture a video snapshot scene (📖 120).
 - 9 Fast playback* backward/forward.
 - 10 Recording date.
 - 11 Jump to the beginning of the next scene.
 - 12 Resume the playback.
 - 13 Capture the displayed frame as a photo (📖 122).
 - 14 Slow playback** backward/forward.
- * Touch several times to increase the playback speed to 5x → 15x → 60x normal speed.
- ** Touch several times to increase the playback speed to 1/8x → 1/4x normal speed.

■ The Scene Information Screen

On the scene information screen you can check various details, including the scene's length, date and time of recording and video quality.







- 1 In the [📺] or [🎬] index screen, touch [i] and then touch the desired scene.
 - The [Scene Info] screen appears.
 - Touch [◀]/[▶] to select the previous/next scene.



2 Touch [] twice to return to the index screen.

■ Repeat Playback

During playback of the desired scene:

Touch the screen to display the playback controls  [] 
[]  []

- The same scene will be played back in a loop. Repeat the procedure to return to normal playback. Stopping the playback will also cancel the repeat playback setting.

■ Mirror Image Playback

During playback of the desired scene:

Touch the screen to display the playback controls  []







- The image will be flipped left to right. Repeat the procedure to end the mirror image playback.

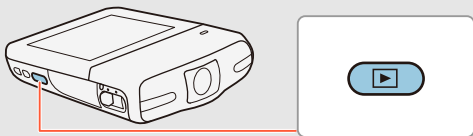

The button

When the camcorder is turned on, press the  button to switch back and forth between playback and recording mode.







- When the camcorder is off, you can press the  button to turn it on directly in playback mode.
- When     [SP-V1 Mode] is set to [**ON** On], playback mode is not available. Instead, you can press the  button to review once the last scene recorded with the camcorder.





- Observe the following precautions while the ACCESS indicator is on or flashing. Failing to do so may result in permanent data loss.
 - Do not remove the memory card.
 - Do not disconnect the power source or turn off the camcorder.
 - Do not press the  button.
- You may not be able to play back with this camcorder movies recorded on or copied onto a memory card using another device.



- You can use the     [Display Date/Time] setting to choose whether to display the recording date when you play back scenes.
- Depending on the recording conditions, you may notice brief stops in video or sound playback between scenes.
- During fast/slow playback, you may notice some anomalies (blocky video artifacts, banding, etc.) in the playback picture. Also, sound will not be output.
- The speed indicated on the screen is approximate.
- Slow reverse playback will look the same as continuous frame reverse.





- Sound will not be output from the built-in speaker while the optional HTC-100 High Speed HDMI cable is connected to the camcorder.

Viewing Photos

Shooting mode



Playback

- 1 Press the button to turn on the camcorder in playback mode.

- The index screen will appear.

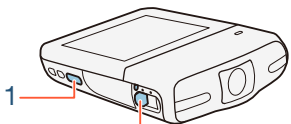

1



- 2 Open the index screen.



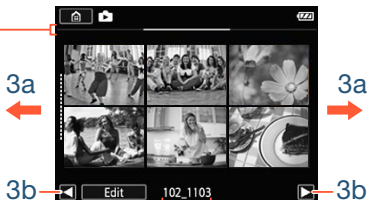

  [ Photo Playback]

Visual bar shows the relative location of the current index screen.





Folder name. The last four digits represent the recording date (1103 = 3 November).

3 Look for the photo you want to view.

- Drag your finger right/left (3a) or touch [] or [] (3b) to display the previous/next index screen.

4 Touch the photo you want to view.

- The photo is displayed in single photo view.
- Drag your finger left/right to browse through the photos one by one.
- To return to the [] index screen:

Touch the screen to display the playback controls  []



■ Photo Jump Function

When you have recorded a large number of photos, you can jump easily through the photos using a scroll bar.

- 1 In single photo view, display the [Photo Jump] scroll bar.

Touch the screen to display the playback controls ➤ [🏠]

- 2 Touch [◀] or [▶], or drag your finger along the scroll bar to find the desired photo.

- 3 Touch [↶] to return to single photo view.

■ Magnifying Photos in Playback



- 1 In single photo view, select the photo you want to magnify.

- 2 Magnify the photo.

Touch the screen to display the playback controls ➤ [🔍]

- The center of the photo is magnified approximately 2 times.



- Touch [] to magnify the image further. Touch [] to reduce the magnification.
- Drag your finger along the magnified area to check other parts of the photo. The white square within the frame represents the approximate location of the portion of the photo that is shown magnified.

3 Touch [] to cancel the magnified view and return to single photo view.

- You can also touch [] repeatedly until the magnified view is canceled.



- Observe the following precautions while the ACCESS indicator is on or flashing. Failing to do so may result in permanent data loss.
 - Do not remove the memory card.
 - Do not disconnect the power source or turn off the camcorder.
 - Do not press the  button.
- The following image files may not be displayed correctly.
 - Images not recorded with this camcorder.
 - Images edited on a computer.
 - Images whose file names have been changed.



Deleting Scenes

You can delete those scenes that you are not interested in keeping. Deleting scenes allows you also to free up space on the memory card.



■ Deleting a Single Scene

- 1 Play back the scene you want to delete (📖 65).
- 2 Pause the playback.

Touch the screen to display the playback controls ➤ [||]

- 3 Delete the scene.

[Edit] ➤ [Delete] ➤ [Yes] ➤ [OK]



■ Deleting Scenes from the Index Screen

- 1 Open the [P] or [M] index screen (📖 65).
 - To delete all the scenes saved in the same folder (recorded on the same date), drag your finger left/right until a scene you want to delete appears.
- 2 Delete the scenes.

[Edit] ➤ [Delete] ➤ Desired option* ➤ [Yes]** ➤ [OK]

- * When you select [Select], perform the following procedure to select the individual scenes you want to delete before touching [Yes].
- ** Touch [Stop] to interrupt the operation while it is in progress. Some scenes may be deleted nevertheless.

To select individual scenes

- 1 Touch on the individual scenes you want to delete.
 - A checkmark ✓ will appear on the scenes you touch. The total number of selected scenes will appear next to the ✓ icon.
 - Touch a selected scene to remove the checkmark. To remove all checkmarks at once, touch [Remove All] ➤ [Yes].
- 2 After selecting all the desired scenes, touch [OK].



Options

[<folder name>]:

Delete all the scenes recorded on a particular date that are stored in the same folder. The last four digits of the folder name that appears in the button indicate the date the folder was created (ex. 1103 = 3 November).

[Select]:

Select individual scenes to delete.

[All Scenes]:

Delete all the scenes.



- Be careful when deleting recordings. Once deleted, scenes cannot be recovered.
- Save copies of important scenes before deleting them (📖 131).
- Observe the following precautions while the ACCESS indicator is on or flashing (while scenes are being deleted).
 - Do not remove the memory card.
 - Do not disconnect the power source or turn off the camcorder.
 - Do not press the  button.





- To delete all movies and make all recordable space available again you may prefer to initialize the memory card (📖 42).

Trimming Scenes

You can trim scenes by removing everything up to a certain point or everything after a certain point. By doing so, you leave only memorable moments to keep for posterity.

Shooting mode



Playback

- 1 Play back the scene you want to trim (📖 65).
- 2 At the point where you want to trim the scene, open the scene trimming screen.



Touch the screen to display the playback controls ▶ [||]
▶ [Edit] ▶ [Trim]



- 3 Bring the scene to a precise point, if necessary.
 - The point at which is movie will be trimmed is indicated by the ⚓ marker.



- Playback controls will appear on the screen ( 67). Use any special playback modes (fast playback, frame reverse/advance) as necessary to locate the desired point.

4 Trim the scene.

[Trim]  [Trim Before Marker] or [Trim After Marker] 
[Save as New] or [Overwrite]

- You can select whether to trim the part before or after the  marker and whether to save the remaining part of the video as a new scene (keeping the original scene) or to overwrite the original scene.
 - Touch [Stop] to interrupt the operation while it is in progress.
-  • You may not be able to correctly trim scenes that were recorded on or copied onto a memory card using another device.
- Interval scenes with the  icon cannot be trimmed.



Deleting Photos

You can delete those photos that you are not interested in keeping.



■ Deleting a Single Photo

- 1** In single photo view, select the photo you want to delete.
- 2** Touch the screen to display the playback controls.
- 3** Delete the photo.

[Edit] ➤ [Delete] ➤ [🗑️ Proceed] ➤ [Yes]

- 4** Drag your finger left/right to select another photo to delete or touch [✕].



■ Deleting Photos from the Index Screen

- 1 Open the [] index screen ( 72).
 - To delete all the photos saved in the same folder (recorded on the same date), drag your finger left/right until a photo you want to delete appears.
- 2 Delete the photos.

[Edit] ➤ [Delete] ➤ Desired option* ➤ [Yes]** ➤ [OK]

- * When you select [Select], perform the following procedure to select the individual photos you want to delete before touching [Yes].
- ** Touch [Stop] to interrupt the operation while it is in progress. Some photos will be deleted nevertheless.

To select individual photos

- 1 Touch the individual photos you want to delete.
 - A checkmark ✓ will appear on the photos you touch. The total number of selected photos will appear next to the  icon.
 - Touch a selected photo to remove the checkmark. To remove all checkmarks at once, touch [Remove All] ➤ [Yes].
- 2 After selecting all the desired photos, touch [OK].



Options

[<folder name>]:

Delete all the photos taken on a particular date. The last four digits of the folder name that appears in the button indicate the date the folder was created (ex. 1103 = 3 November).

[Select]:

Select individual photos to delete.

[All Photos]:

Delete all the photos.



- Be careful when deleting photos. Deleted photos cannot be recovered.
- Photos that were protected with other devices cannot be deleted with this camcorder.



Slideshow

You can play a slideshow of all the photos.



- 1 Open the [📷] index screen (📖 72).
- 2 Touch the photo that will open the slideshow to display it in single photo view.
- 3 Start the slideshow.

Touch the screen to display the playback controls ➤ [▶]

- During the photo slideshow, touch the screen and touch [⏏] to stop the slideshow.

To change the slideshow's transition effects from the index screen

🏠 ➤ [⚙️ Other Settings] ➤ [📷] ➤ [Slideshow Transition] ➤ [OFF Off], [🌊 Dissolve] or [📄 Slide Image] ➤ [X]





Advanced Functions

Video Quality and Shooting Modes

87

This section explains how to change the video quality of your recordings and how to use the camcorder's various shooting modes to get perfect recordings when you are shooting fashion scenes, dance training sessions, night scenes or many other special scenes.

Special Recording Modes

94

This section explains how you can use interval recording to create time-lapse scenes, slow and fast motion for unique recordings, or video snapshot scenes for a fast-paced, interesting video clip.

Convenient Functions

102

This section introduces some of the camcorder's functions that you may find convenient in special situations. For example, self timer, fun decorations for your scenes, mirror image recording and audio scene selection.



When You Want More Control

This section explains functions you can use when you want more control over how your recordings look. It is more oriented for advanced users and covers functions such as white balance, exposure compensation and frame rate.



Video Quality and Shooting Modes

Selecting the Video Quality

The camcorder offers three video quality options (bit rates*) for recording movies. Select 24 Mbps for higher video quality; select 4 Mbps for longer recording times or smaller file sizes. The table following the procedure (📖 88) gives approximate recording times.

* Bit rate (measured in Mbps) indicates how much information is recorded in 1 second of video and therefore affects also the recording time available on the memory card.



Approximate recording times

Memory card	Video quality (Resolution)		
	24 Mbps (1920x1080)	17 Mbps (1920x1080)	4 Mbps (1280x720)
8 GB	40 min.	1 hr.	4 hr. 20 min.
16 GB	1 hr. 25 min.	2 hr. 5 min.	8 hr. 40 min.
32 GB	2 hr. 55 min.	4 hr. 10 min.	17 hr. 20 min.*
64 GB	5 hr. 55 min.	8 hr. 20 min.	34 hr. 45 min.*

* Using the optional CA-110 Compact Power Adapter, a single scene can be recorded continuously for 12 hours. After that, recording will continue as a separate scene.



- Depending on the device used, you may not be able to play back your recordings on other devices.
- The camcorder uses a variable bit rate (VBR) to encode video so the actual recording times will vary depending on the content of the scenes.
- Long scenes, whose video data exceeds 4 GB, will be recognized as multiple files on other devices.



Selecting the Photo Size

Photos are recorded as JPG files. The camcorder offers three photo sizes but the photo quality cannot be changed. As a general rule, select a larger photo size for higher quality.



Approximate number of photos available on a 4 GB memory card ◆ Default value

Photo size	Number of photos
[L 4000x3000]◆	750
[M 1920x1440]	3,200
[S 640x480]	23,500

- 
 • Even if the photo size was set to **L**, it will change automatically to **M** size when you set the field of view to close-up.

Selecting the Shooting Mode

In addition to **AUTO** mode, the camcorder features a number of shooting modes that offer the most appropriate settings for a variety of special scenes. You can also use the **P** shooting mode when you want the camcorder to set the exposure automatically but control manually some advanced settings.



Shooting mode button



- 1 Touch the shooting mode button on the top left corner of the screen.
 - The button will show the icon of the shooting mode currently selected. If the camcorder is set to **AUTO** mode, the button will show one of the Smart AUTO icons (see page 59).
 - Alternatively, you can open the shooting mode selection screen from the (Home) menu: [Shooting Mode].



- 2** Drag your finger up/down to bring the desired shooting mode to the center and then touch [OK].

Options (◆ Default value; SCN - special scene shooting mode)

[**AUTO** Auto]◆

Let the camcorder take care of most of the settings while you concentrate on recording (📖 54). Great for beginners or if you just prefer not to bother with detailed camcorder settings.



[🍴 Food and Fashion] (**SCN**)

To record fashion or food related scenes with vivid colors.



[🏃 Sports] (**SCN**)

To record scenes with lots of movement, such as sport events and dance scenes.



[🌃 Night Scene] (**SCN**)

To record nightscapes with lower noise.



Video Quality and Shooting Modes

[🏖️ Beach] (SCN)

To record on a sunny beach without the subject being underexposed.



[🎿 Snow] (SCN)

To record in bright ski resorts without the subject being underexposed.



[🌻 Macro] (SCN)

The camcorder can focus at a shorter distance, allowing you to get closer shots of flowers or insects. Close subjects will also stand out more because of the fisheye effect of the ultra wide angle lens.



[P Programmed AE]

The camcorder automatically sets the shutter speed and aperture but you have the option to adjust the white balance (📖 112) and exposure (📖 114), and change the frame rate (📖 182).





- [Sports]/[Beach]/[Snow]: The picture may not appear smooth during playback.
- [Beach]/[Snow]: The subject may become overexposed on cloudy days or in shaded places. Check the image on the screen.
- [Macro]: The camcorder can focus on a subject as close as 20 cm (7.9 in.).



Special Recording Modes

Interval Recording

You can easily set the camcorder to record half a second of video or a photo at fixed intervals from 5 seconds to 10 minutes. When recording video using interval recording, you can join all these short bits of video (interval scenes) into a single time-lapse scene that captures the passage of time.

Sound is not recorded in this special recording mode.



1 Make sure the camcorder has sufficient power to complete the operation.

- Insert a fully charged battery pack or use the optional CA-110 Compact Power Adapter.

2 Activate interval recording.

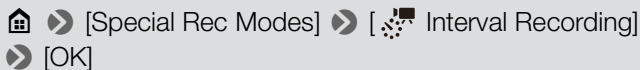

- The default recording interval is 5 seconds. Before touching [OK], you can change the recording interval with the following procedure.



-  and the selected interval length will appear on the screen. Also, the remaining video recording time will automatically be reduced by about half.

3 Start recording with interval recording.

- Movies: Touch [●] to record the first video.
Photos: Press the photo button, first halfway, then fully.
- The camcorder will continue recording interval scenes or photos at the set interval. The number of videos/photos recorded so far, and a countdown until the next recording is made will be displayed on the screen.

4 Press the button and then touch [Yes] to end interval recording mode.

- Interval recording mode will end. If you were recording a series of photos, the rest of the procedure is not necessary.
- If you were recording video, continue the procedure to join all the interval scenes into a single time-lapse scene.

5 Touch [Yes] to join the interval scenes.

- If you prefer to join the interval scenes later on, touch [No] instead. The rest of the procedure is not necessary.
- You can touch [Stop]  [OK] to interrupt the operation while it is in progress. The index screen will appear, displaying the folder where the interval scenes are saved.

6 Touch [OK].



7 Touch [Yes] to delete the original interval scenes.

- If you prefer to keep the original interval scenes even after they were successfully joined, touch [No] instead.
- You can touch [Stop] to interrupt the operation while it is in progress.

8 Touch [OK].

- A new time-lapse scene, created from all the interval scenes, will be added to the [📺] index screen.

To change the recording interval

You can change the recording interval while activating interval recording (from the [⌚] Interval Recording] selection screen) or from the record standby screen after interval recording is activated.

[👉] ➤ Desired interval ➤ [↶]

To join interval scenes later on

Even if you did not join videos recorded using interval recording immediately after recording them, you can do so at a later date.

1 Open the [📺] index screen (📖 65).

2 Touch an interval scene marked with the ⌚ icon.



3 Touch [Join] and continue from step 5 in the previous procedure (📖 95).



- Face detection and tracking, decoration, exposure adjustment and Wi-Fi functions cannot be used during interval recording. In **AUTO** mode, the Smart AUTO function that automatically adjusts the brightness or color will be disabled as well.
- The maximum recording time in interval recording mode depends on the selected recording interval.

Recording interval	Maximum recording time
5 sec., 10 sec., 30 sec.	3 hours
1 min.	6 hours
10 min.	60 hours

- Depending on the memory card used, writing on the memory card may take longer, and the actual recording interval may be longer than the recording interval that was selected.





- When you select a recording interval of 30 seconds or longer, the camcorder will enter standby mode when it is not recording in order to save power. In standby mode the screen will turn off and the power indicator will light up in red.

Slow and Fast Motion

You can use slow motion or fast motion to record movies with a unique look. Sound is not recorded in this special recording mode.



1 Activate slow/fast motion.

[Special Rec Modes] [Slow Motion] or [Fast Motion] [OK]

- Before touching [OK], you can change the playback speed with the following procedure.
- or and the selected speed will appear on the screen.



2 Touch [●]/[■] to record scenes in slow/fast motion.

To change the playback speed

You can change the playback speed while activating slow/fast motion (from the [📺] Slow Motion/[📺] Fast Motion selection screen) or from the record standby screen after slow/fast motion is activated.

[👉] ➤ Desired speed ➤ [↩]



- Using the optional CA-110 Compact Power Adapter, the maximum continuous recording time using slow motion is 6 hours ([x1/2] speed) or 3 hours ([x1/4] speed). After that, recording will continue as a separate scene.
- When recording using slow motion, the video quality will change automatically to 4 Mbps/1280x720 ([x1/2] speed) or 3 Mbps/640x360 ([x1/4] speed).
- Even if the frame rate was set to 24P, it will change automatically to 30P when recording using slow/fast motion.



Video Snapshot

You can record a series of short scenes, each a few seconds long. When you play the video snapshot scenes one after the other, this will result in fast-paced, dynamic video. You can also record a video snapshot scene every time you record a photo.



1 Activate video snapshot.

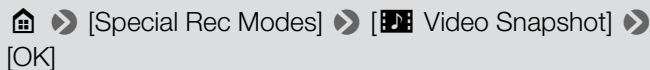

- The video snapshot icon and the video snapshot length currently selected, and a blue border appear on the screen.

2 To record only a video snapshot scene: Touch [●].









- The camcorder records for about 4 seconds (the blue frame serves as a visual progress bar) and then automatically returns to record standby mode.



3 To record a photo along with a video snapshot scene: Press the photo button, first halfway, then fully.

- The camcorder records a photo and about 4 seconds of video after that. Then, the camcorder returns to record standby mode.



- You can change the length of the video snapshot scenes recorded to 2 or 8 seconds with the     [Video Snapshot Length] setting.
- During video snapshot recording, the recording of the video snapshot scene will start immediately after a photo is recorded. The photo will not be displayed for review, regardless of the     [Photo Review Time] setting.



Convenient Functions

Self Timer



- or will appear on the screen.
- Repeat, selecting [**OFF** Off], to turn off the self timer.

Movies: In record standby mode, touch [**●**].

The camcorder starts recording after a countdown. The countdown appears on the screen.

Photos: In record standby mode, press the photo button, first halfway, then fully.

The camcorder will record the photo after a countdown. The countdown appears on the screen.





- Once the countdown has begun, any of the following actions will cancel the self timer.
 - Touching [●] again, when recording movies.
 - Pressing the photo button, when recording photos.
 - Turning off the camcorder.
 - Pressing the [▶] button.

Decoration: Adding a Personal Touch

Add a new level of enjoyment to your scenes by decorating them. You can add animated graphics, stamps and even your own freehand drawing easily just by simply using your fingertip. You can also add decorations just before converting/resizing scenes (📖 128).

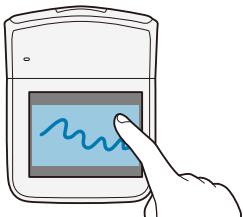

Decorating Scenes while Recording





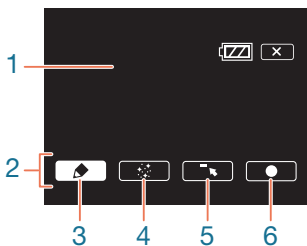

- 1** In record standby mode, touch [] to open the decoration screen.
- 2** Use a tool from the toolbar as explained in the following procedures.
- 3** Touch []/[] to record movies with your decorations.
 - You can add decorations even while recording a scene.
- 4** Touch [] to exit the decoration screen.





- 1** Canvas - The area where you will draw and see your decorations in action.
- 2** Toolbar.



- 3 [ Pens and Stamps] Select the type of pen or stamp and its color. You can also save a single canvas or load a previously saved canvas.
- 4 [ Animated Stamps] Select animated stamps to add to your decoration.
- 5 [] Minimize the toolbar to the top of the screen to view almost all of the canvas. Touch [] to restore the toolbar.
- 6 [] Start recording video with the decorated canvas overlaid on the live image.



- When  [ Mirror Image] is set to [Off], decoration is not available when you rotate the LCD panel toward the lens (so it can be viewed from the front of the camcorder).

■ To Use [Pens and Stamps]

Shooting mode

AUTO



P



Playback

- 1 Touch [].

- The [Pens and Stamps] screen will appear.



2 Select the desired pen or stamp from [Tools].

- The main decoration screen will appear again.

3 Draw freely on the canvas with your fingertip.

- To select a different pen or stamp: Repeat steps 1 and 2.
- To change color: Touch [🖍] and then touch the white or black button under [Colors]. Alternatively, touch [🖍] ➡ [🎨] and select a color from the color palette.
- To clear your freehand drawings and stamps: Touch [🖍] ➡ [Clear] ➡ [Yes] ➡ [↶].
- To save your freehand drawings and stamps on the memory card: Touch [🖍] ➡ [SD Save] ➡ [Yes] ➡ [↶].
- To load a previously saved canvas (freehand drawings and stamps only) from the memory card: Touch [🖍] ➡ [SD Load] ➡ [Yes] ➡ [↶]. During playback, you will need to pause the playback before loading a previously saved canvas file.

■ To Use [Animated Stamps]

Shooting mode

AUTO



P



Playback



1 Touch [🎯].

- The [Animated Stamps] screen will appear.



- 2 Touch one of the buttons.
- 3 Touch anywhere on the canvas to place the selected animated stamp. You can also drag some animated stamps to a different location.

■ Decorating Scenes during Playback

Have fun decorating movies while playing them back with friends and family. Decorations added during playback are not recorded with scene. If you want to decorate a previously recorded scene and save the decorations, convert the scene using the same video quality settings and decorate it during the conversion (📖 128). This will create a new scene with decorations, in addition to the original scene.



- 1 Play back the scene you want to decorate (📖 65).
- 2 Touch the screen to display the playback controls.
- 3 Touch [] to display the decoration toolbar.



4 Decorate the scene using the tools from the toolbar as explained in the previous sections.

- In playback mode, the [●]/[■] button is replaced by [||]/[▶]. Touch [||] to pause the playback; touch [▶] to resume.

Image Rotation and Image Flipping

The camcorder offers two functions to manipulate how the image is recorded or played back. Using mirror image recording, the camcorder will record the image reversing left and right. When orientation detection is turned on, the camcorder will detect if it is turned sideways or upside-down while recording so the image can be corrected during playback.



Home > [Flip/Rotate Image] > [Mirror Image] or [Detect Orientation] > [On] > [X]

- The icon of the selected function will appear on the screen.
- Select [Off] instead to turn off the function.



Example of image flipping



[Mirror Image] set to [Off]







[Mirror Image] set to [On]

Examples of image rotation when [Detect Orientation] is set to [On]





Recording		Playback	
Camcorder's orientation*	Onscreen icon	Movies**	Photos***



Recording		Playback	
Camcorder's orientation*	Onscreen icon	Movies**	Photos***
			

* As seen from the back of the camcorder, with the lens pointing forward.

** Even when orientation detection is turned on, movies recorded with the camcorder turned sideways cannot be played back in vertical orientation using the camcorder.

***To display photos in the correct orientation, orientation detection should be turned on while recording and    /   [Auto Rotate] should be set to [**ON** On] during playback.

Audio Scenes

You can have the camcorder optimize the audio settings of the built-in microphone by selecting the audio scene that matches your surroundings. This will greatly enhance the sense of presence of your scenes.



  [Audio Scene]  Desired audio scene  [OK]

Options (◆ Default value)

[Standard]◆

To record most general situations. The camcorder records with standard settings.

[Music]

To vibrantly record music performances and singing indoors.

[Speech]

Best for recording human voices and dialog.

[Forest and Birds]

To record birds and scenes in forests. The camcorder clearly captures sound as it spreads.

[Noise Suppression]

To record scenes while reducing noise from wind, passing vehicles and similar ambient sound. Ideal for recording at the beach or in places with a lot of noise.



- During interval recording and slow/fast motion, there is no audio recording and the [Audio Scene] setting cannot be changed.



When You Want More Control

White Balance

The white balance function helps you to accurately reproduce colors under different lighting conditions so that white objects will always look truly white in your recordings.



- 1** Select the [**P** Programmed AE] shooting mode (📖 90), but do not touch [OK].
- 2** Touch [**WB**] to open the white balance selection screen.
- 3** Select the desired white balance option.
 - When you select [**Custom WB**], set the custom white balance with the following procedure.
- 4** Touch [**X**] to set the shooting mode to **P** and apply the selected white balance.
 - The icon of the selected white balance setting will appear on the screen.



To set the custom white balance

1 Point the camcorder at a white object, so it fills the frame at the center of the screen.

2 Touch [Set WB].

When the adjustment is completed,  stops flashing and disappears. The camcorder will retain the custom white balance even if you turn it off.

3 Touch [].

Options (◆ Default value)

[AWB Automatic]◆

The camcorder automatically sets the white balance for natural looking colors.

[ Daylight]

To record outdoors.

[ Tungsten]

To record under tungsten and tungsten-type 3-wavelength fluorescent lighting.

[ Custom WB]

Use the custom white balance setting to make white subjects appear white under colored lighting.





- **When you select the custom white balance:**
 - Reset the white balance when you change locations or the lighting or other conditions change.
 - Depending on the light source,  may keep flashing. The result will still be better than with [AWB Automatic].
- Custom white balance may provide better results in the following cases.
 - Changing lighting conditions.
 - Close-ups.
 - Subjects in a single color (sky, sea or forest).
 - Under mercury lamps, certain types of fluorescent lights and LED lights.

Exposure

The camcorder determines the optimal exposure of a scene based on the average brightness of the whole picture. When you want to record a subject that is much brighter or darker than its surroundings, the automatic exposure obtained by the camcorder may not be best for that specific subject.

To correct this, you can compensate the exposure to make the whole picture brighter or darker, you can use Touch AE to tell the camcorder to optimize the exposure for a selected subject, or you can use a combination of both.







- Select a shooting mode other than [**AUTO** Auto].

- 1** Select the desired shooting mode (📖 90), but do not touch [OK].
- 2** Touch [] to open the exposure adjustment screen.

■ Exposure Compensation

- 1** Touch [**M**].
 - The exposure is locked and the exposure compensation dial appears with the compensation value set at ± 0 .
 - Touch [**M**] again to return the camcorder to automatic exposure.
- 2** Touch [] or [], or drag your finger along the dial to compensate the exposure.
 - + values will make the picture brighter; – values will make it darker.



- The compensation range may vary depending on the initial brightness of the image, and some values may be grayed out.

3 Touch [X] to apply the selected shooting mode and exposure compensation value.

- During exposure lock,  and the exposure compensation value will appear on the screen.

■ Touch AE

1 Touch a subject that appears inside the frame.

- The Touch AE mark () will flash and the exposure will be optimized automatically for the subject you selected.
- Touch [M] to return the camcorder to automatic exposure.

2 Touch [X] to apply the selected shooting mode and adjusted exposure.

- Using Touch AE also locks the exposure (the exposure compensation dial appears with the compensation value set at ± 0). Before touching [X], you can compensate the exposure further (steps 2 and 3 in the previous procedure).
- During exposure lock,  and the exposure compensation value will appear on the screen.





- If the shooting mode is changed during exposure compensation, the camcorder will return to automatic exposure.
- By default, the camcorder corrects for backlight conditions. You can turn off the automatic correction with the [Auto Backlight Correction] setting.

Face Detection

The camcorder automatically detects people's faces and uses this information to set the correct exposure.



* Face detection is always activated in **AUTO** mode.

By default, face detection is activated so you can skip step 1 in the following procedure. If the function was turned off, perform the following procedure starting from step 1.

1 Activate face detection.

[Other Settings] [Face Detection & Tracking] [**ON** On] [



2 Point the camcorder at a person.

- If there is more than one person in the picture, the camcorder will automatically select one person it determines is the main subject. The main subject is indicated by a white frame and the camcorder will optimize the settings for that person. Other faces will have gray frames.

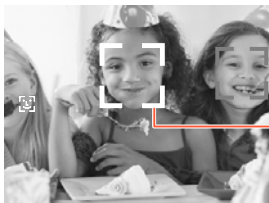

Main subject

3 Touch a different face on the touch screen to optimize the exposure for another person.

- A white double frame will appear around the selected person's face.
- Touch [Cancel 



- The camcorder may mistakenly detect the faces of non-human subjects. In such case, turn face detection off.





- In certain cases, faces may not be detected correctly. Typical examples include:
 - Faces extremely small, large, dark or bright in relation to the overall picture.
 - Faces turned to the side, at a diagonal or partially hidden.
- Face detection is not available in the following cases.
 - While recording using interval recording or slow/fast motion.
 - While the camcorder is controlled remotely from an iOS/Android device.
 - When the exposure was adjusted manually.



Capturing Video Snapshot Scenes and Photos from a Movie

You can capture video snapshot scenes or photos from a previously recorded scene. For example, you may want to print photos from video recorded at a party or create a small video clip using video snapshot scenes from the highlights of an event.

■ Capturing a Video Snapshot Scene







- 1** Play back the scene from which you want to capture the video snapshot scene (📖 65).
- 2** At the point where you want the video snapshot scene to start, touch the screen to display the playback controls.
- 3** Touch [🎵].
 - The camcorder captures the video snapshot scene for about 4 seconds (the blue frame serves as a visual progress bar), and then enters playback pause mode.



4 Touch [■] to stop the playback.

- The new video snapshot scene will be saved in a folder corresponding to the date when it was captured.



- You can change the length of the video snapshot scenes you capture to 2 or 8 seconds with the     [Video Snapshot Length] setting.
- A video snapshot scene can be captured only during playback; it cannot be captured during playback pause mode.
- Video snapshot scenes cannot be captured from scenes shorter than 1 second.
- When the source scene is itself a video snapshot scene, you may not be able to capture a video snapshot scene depending on the length of the source scene and the length currently selected for video snapshot scenes.
- When you start capturing a video snapshot scene less than 1 second from the end of the scene, the video snapshot scene will be captured starting from the beginning of the following scene.



■ Capturing Photos

Shooting mode

AUTO



P



Playback



- 1 Play back the scene from which you want to capture the photo (📖 65).
- 2 At the point you want to capture, pause the playback and capture the photo.

Touch the screen to display the playback controls ▶ [||]
▶ [PHOTO]

- 3 Touch [■] to stop the playback.



- The size of photos captured from a scene is 1920x1080 (16:9 aspect ratio).
- The data code of the photos will reflect the date and time of recording of the original scene.
- Photos captured from a scene with a lot of fast movement may be blurred.





External Connections

124

Terminals on the Camcorder

This section gives more details about the camcorder's output terminals and presents connection diagrams for connecting your camcorder to other devices.

127

Playback on a TV Screen

This section explains how to connect the camcorder to an HDTV using the optional HTC-100 High Speed HDMI Cable.

128

Saving and Sharing Your Recordings

Finally, this section explains how to convert movies to smaller video files and how to upload movies and photos to a computer using the supplied USB cable.

* Note that this chapter presents only connections to other devices using cables (wired connections). To enjoy the camcorder's convenient wireless connections, refer to **Wi-Fi Functions** (📖 138).

Terminals on the Camcorder

Open the side terminal covers to access the terminals on the camcorder.

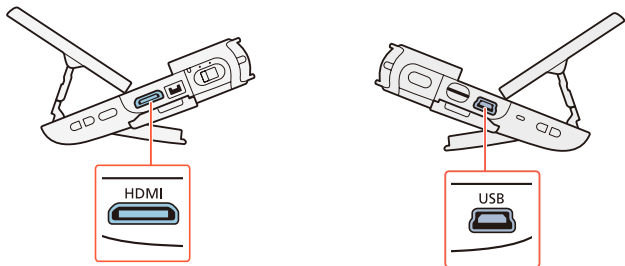

1 HDMI Terminal

The HDMI terminal offers a high-quality digital connection that combines audio and video in a single convenient cable. This terminal is an HDMI mini receptacle. When using a commercially available HDMI cable, make sure the HDMI cable is Type A to Type C.

2 USB Terminal

This terminal is a mini-B receptacle. You can use the supplied USB cable to connect to a computer or other digital devices with standard-A receptacles.



Connection Diagrams

In the following connection diagrams, the left side shows the terminals on the camcorder and the right side shows (for reference only) an example of terminals on a connected device.

Connection 1

HDMI

Type: Digital • Quality: High definition • Output only

Connect to a high-definition TV (HDTV) with an HDMI input terminal.

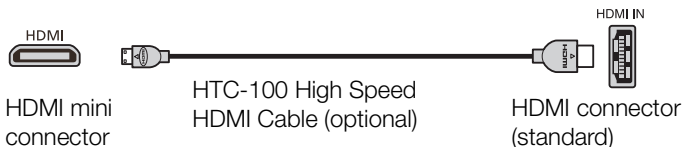

About the HDMI™ connection

The HDMI (High-Definition Multimedia Interface) connection (1) is a convenient all-digital connection using a single cable for both video and audio. When you connect the camcorder to an HDTV equipped with an HDMI terminal, you can enjoy video and audio playback at the highest quality.



Connection 2

USB

Type: Digital data connection

Connect to a computer to save your recordings.

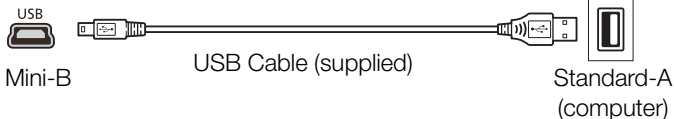

- The HDMI terminal on the camcorder is for output only. Do not connect it to an HDMI output terminal on an external device, as this may damage the camcorder.



- Correct operation cannot be guaranteed when connecting the camcorder to DVI monitors.
- Depending on the HDTV, correct playback of personal video content may not be possible using connection 1.
- Sound from the built-in speaker will be muted while a cable is connected to the HDMI terminal.
- Audio and video will not be output from the HDMI terminal while Wi-Fi functions are in use.



Playback on a TV Screen

Connect the camcorder to a TV to enjoy your recordings with family and friends.

Shooting mode

AUTO



P

Playback



- 1 Turn off the camcorder and the TV.
- 2 Connect the camcorder to the TV.
 - Connection 1. Refer to **Connection Diagrams** (📖 125).
- 3 Turn on the connected TV.
 - On the TV, select as the video input the same terminal to which you connected the camcorder. Refer to the instruction manual of the connected TV.
- 4 Turn on the camcorder and set it to playback mode. Open the desired index screen (📖 65, 72).
 - Play back the desired movies or photos.



Saving and Sharing Your Recordings

Converting and Resizing Movies

You can convert scenes to a lower video quality (down-conversion) to obtain smaller file sizes. This is convenient, for example, when you want to upload videos to the Web, as smaller video files will upload faster. Additionally, when you convert a scene, you can apply unique cinema-look filters and decorations to the converted copy.

The converted movies are saved as new scenes so you always keep your original movies.





- 1 Open the [📺] or [📺] index screen (📖 65).
- 2 Open the screen for selecting scenes to convert.

[Edit] ➤ [Convert to MP4] ➤ [OK] ➤ Desired video quality of converted movies*

* Before selecting the video quality, touch [Join Scenes] to join the converted movies into a single scene.



- 3 Touch the individual scenes you want to convert.



- A checkmark ✓ will appear on the scenes you touch. The total number of selected scenes will appear next to the  icon.
- Touch a selected scene to remove the checkmark. To remove all checkmarks at once, touch [Remove All]  [Yes].



4 After selecting all the desired scenes, touch [OK] and then touch [Next].

- **To add a cinema-look filter*:** The camcorder offers 7 cinema-look filters. You can read a description of each filter and preview its effect on the screen.

[FILTER 1]  Select the desired filter  [OK]

To deactivate the cinema-look filter, touch the [FILTER] button again.

- **To add decorations*:**

  Decorate the scene (📖 103)  [X]

* When a cinema-look filter is applied to a movie, you cannot add decorations.



5 Touch [START] to convert the scene.

- Touch [STOP] to interrupt the operation while it is in progress.

6 Touch [OK].

Options for converting and resizing movies

Video quality and resolution of the original scene	Video quality and resolution of the converted scene		
	24 Mbps (1920x1080)	17 Mbps (1920x1080)	4 Mbps (1280x720)
24 Mbps (1920x1080)	●	●	●
17 Mbps (1920x1080)	●	●	●
4 Mbps (1280x720)	—	—	●



- After repeatedly recording, deleting and editing scenes (fragmented memory), MP4 conversion may stop working correctly.





- The following scenes cannot be converted/resized using MP4 conversion.
 - Slow motion scenes recorded using 3 Mbps video quality ([x1/4] speed).
 - Interval scenes with the  icon.
- Scenes recorded using different frame rates cannot be joined into a single scene during MP4 conversion.

Saving Recordings on a Computer

Make sure to save your recordings on a computer on a regular basis. This section explains how to save your recordings on a computer using a USB connection and the supplied software **ImageBrowser EX**.

Refer to 'ImageBrowser EX User Guide' (PDF file) for the full system requirements and other information.

Installation

Install the software before you connect the camcorder to the computer for the first time. Make sure to install the software even if you have a different version of **ImageBrowser EX** on your computer. The auto-update function of the software may make available to you features optimized for this camcorder.



Saving and Sharing Your Recordings

The 'ImageBrowser EX User Guide' will also be installed with the software.



- Before installing the software, make sure your computer is connected to the Internet.

- 1** Insert the VIXIA mini CD-ROM into the computer's disc drive.
- 2** Windows: Use Windows Explorer to open the drive into which you inserted the CD-ROM.
Mac OS: Use Finder and click on the CD-ROM icon.
- 3** Click/Double-click the Disc_Setup icon .
- 4** Click [ImageBrowser EX].
- 5** Follow the onscreen instructions to select your area (continent), country/region and language.
 - Available options will vary depending on your country/region.
- 6** In the main installer panel, click [Easy Installation].
 - For Windows users, if a User Account Control dialog box appears, follow the instructions.





7 Follow the onscreen instructions to complete the installation.

- During the installation process, you may be prompted to install Microsoft Silverlight. Follow the instructions to do so.
- **CameraWindow** will also be installed.

To check that the software was installed correctly

You can check that the software was installed correctly by looking for the ImageBrowser EX icon in the following location.



Windows 7, Windows Vista, Windows XP:

The shortcut will be added to the Desktop screen.

Windows 8: The icon will be added as a tile on the Start screen.

Mac OS: In the Dock.

If you cannot find the icon, check your Internet connection and install the software again.



First-time connection to a computer running Windows

The first time you connect the camcorder to the computer, you also need to select the **CameraWindow** auto-launch setting.

Connecting the Camcorder to a Computer

Shooting mode

AUTO



P

Playback



- 1 Open the desired index screen (📖 65, 72).
- 2 Connect the camcorder to the computer using the supplied USB cable.
 - Connection 2. Refer to **Connection Diagrams** (📖 126).
 - Camcorder: When the connection is successfully established, [USB Connection] appears on the screen.
 - Computer: **CameraWindow** will start automatically.
Windows users only: If you did not set up the auto-launch setting, open **CameraWindow** manually.
- 3 Save the recordings onto the computer.
 - Refer to **Non-EOS DIGITAL Cameras: Importing Images with CameraWindow** in the 'ImageBrowser EX User Guide'. This PDF file can be accessed through the ? menu on the upper right of the **ImageBrowser EX** main screen.





- **When the camcorder is connected to a computer:**
 - Do not remove the memory card.
 - Do not change or delete any of the memory card's folders or files directly from the computer as this may result in permanent data loss. When saving recordings on a computer, we recommend using **Image-Browser EX**.
- Observe the following precautions while the ACCESS indicator is on or flashing. Failing to do so may result in permanent data loss.
 - Do not remove the memory card.
 - Do not disconnect the USB cable.
 - Do not turn off the camcorder or the computer.
 - Do not press the  button.
- If you wish to use the recordings on your computer, make copies of them first. Use the copied files, retaining the originals.



- Depending on the computer, the software may not work correctly or you may not be able to play back movies.
- Interval scenes with the  icon cannot be played back on a computer.





- Regardless of the charge conditions of the battery pack in the camcorder, Battery Capacity on the camcorder's details area of **CameraWindow**'s main screen will always appear as 'Full'.
- Long scenes, whose video data exceeds 4 GB, will be recognized as multiple files on other devices.
- **Users of Windows 8, Windows 7, Windows Vista, Windows XP and Mac OS X:** Your camcorder is equipped with the standard Picture Transfer Protocol (PTP) allowing you to transfer photos (JPEG only) simply by connecting the camcorder to a computer using the supplied USB cable, without having to install the supplied software **ImageBrowser EX**.



Uploading Recordings to the Web

With the supplied software **ImageBrowser EX**, you can also upload your movies to YouTube and photos to Facebook from your computer. Additionally, you can use CANON iMAGE GATEWAY* to make photo albums and more.

* This service may not be available in all countries/regions.

Installation

Install the software before you connect the camcorder to the computer for the first time. The software is compatible with computers running Windows or Mac OS operating systems. Refer to **Saving Recordings on a Computer** (📖 131).

Connecting to the Computer and Uploading Your Recordings

Refer to the relevant sections in the 'ImageBrowser EX User Guide'. This PDF file can be accessed through the ? menu on the upper right of the **ImageBrowser EX** main screen.





Wi-Fi Functions

140

The Camcorder's Wi-Fi Functions

This is an overview of the Wi-Fi functions offered by the camcorder and contains also important information about the supported Wi-Fi standards.

145

Wireless Connections Without an Access Point

This section covers functions you can use after connecting your camcorder directly to an iOS or Android device*.

154

Sharing Recordings with CANON iIMAGE GATEWAY**

Connect the camcorder to an access point on your home network to share recordings on CANON iIMAGE GATEWAY. From there you can use a variety of Web services to enjoy your recordings.



Wireless Connections Using an Access Point

This section explains how to connect your camcorder to an access point (wireless router) on an existing Wi-Fi network, for example, your home wireless network.

- * “iOS device” is used in this text to refer to Wi-Fi-enabled iPhones and iPads, while “Android device” refers to Wi-Fi-enabled Android smartphones and tablets.
- ** The availability of this Web service varies from area to area. For the latest information, visit your local Canon Web site.



The Camcorder's Wi-Fi Functions

You can use the camcorder's Wi-Fi functions to connect wirelessly to Wi-Fi enabled devices* like smartphones or tablets and save, play back and upload your recordings. Refer to **Glossary** (📖 175) for a definition of the frequently used terms in this text.

* "iOS device" is used in this text to refer to Wi-Fi-enabled iPhones and iPads, while "Android device" refers to Wi-Fi-enabled Android smartphones and tablets.

iOS Devices

- Install the CameraAccess app and use your iPhone or iPad as a remote control to record with the camcorder (📖 145). You can even stream video from the camcorder and record it directly on your iOS device.
- Installing the Movie Uploader app, you can save recordings on your iOS device and even upload them to YouTube or Facebook (📖 151).
- Use a Web browser to access the camcorder and play back recordings on your iOS device (📖 148).



Movie Upload



CameraAccess



Android Devices

- Install the CameraAccess app and use your smartphone or tablet as a remote control to record with the camcorder (📖 145). You can even stream video from the camcorder and record it directly on your Android device.
- Use a Web browser to access the camcorder and play back recordings on your Android device. You can also save a local copy on your Android device (📖 148).



CameraAccess



Computers and Other Wi-Fi Devices

- On computers with a Wi-Fi receiver, use a Web browser to access the camcorder and play back recordings on the device. You can also save a local copy on the computer (📖 148).
- Connect the camcorder to an access point as a media server and play back your recordings on computers and other devices connected to the same home network (📖 161).

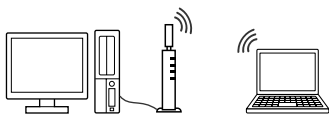

CANON IMAGE GATEWAY

- Connecting the camcorder to an access point (home network) connected to the Internet, you can also share recordings on CANON IMAGE GATEWAY and enjoy a number of Web services, including uploading recordings to Facebook and YouTube (📖 154).



■ Before Using Wi-Fi Functions

Based on the function, the camcorder will wirelessly connect directly to a Wi-Fi-enabled device, such as a smartphone, or to a Wi-Fi network via an access point (wireless router)*. After selecting the function you want to use, follow the onscreen directions to connect the camcorder.

* Depending on the manufacturer, the access point may be referred to using a different name, such as wireless LAN router or wireless network router.

About the camcorder's Wi-Fi standard

The camcorder's Wi-Fi standard complies with the IEEE 802.11b/g/n protocol and operates in the 2.4 GHz band. As such, the maximum data transfer rate is 11 Mbps for IEEE 802.11b, 54 Mbps for IEEE 802.11g, and 150 Mbps for IEEE 802.11n. Note that these are theoretical values and actual data transfer rates may differ.



- Using an unprotected Wi-Fi network can expose your files and data to monitoring by unauthorized third parties. Be aware of the risks involved.



The Camcorder's Wi-Fi Functions



- We recommend inserting a fully charged battery pack or using the optional CA-110 Compact Power Adapter when using Wi-Fi functions.
- When using the camcorder's Wi-Fi functions, do not cover the front left corner of the camcorder with your hand or other object. The Wi-Fi antenna is located there and covering it may interfere with wireless signals.
- Do not remove the memory card during the wireless connection.
- While using Wi-Fi functions, the camcorder's automatic power off function will be disabled.

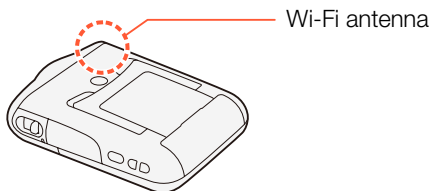

Wireless Connections Without an Access Point

Using an iOS or Android Device as a Remote Control

Using the CameraAccess app* for iOS devices and Android™ devices, you can control the camcorder from a distance while you view the camcorder's image on the device's screen. You can use your device as a remote control and you can even record the image streamed from the camcorder directly onto your device.

* The CameraAccess app, provided by PIXELA, is available for free from the App Store (iOS devices) and Google Play™ (Android devices).



** Even if the camcorder was set to a different shooting mode, it will change automatically to **AUTO** mode when using CameraAccess.





- Before you perform this procedure for the first time, download and install the CameraAccess app on your iOS/Android device. The app can be downloaded for free from the following Web sites.

App Store:

<http://appstore.com/cameraaccess>

Google Play™:

<http://play.google.com/store/apps/details?id=jp.co.pixela.cameraaccess>

1 Camcorder: Turn on the camcorder (recording mode).

- Adjust the position of the camcorder. Change the field of view (📖 57) or other settings to make sure you are getting the image you want to record.

2 Camcorder: Activate the remote control/streaming mode.

   Remote Control+Streaming]

- The camcorder's SSID (network name) and password will appear.
- The camcorder will be ready to connect with the iOS or Android device.



3 iOS/Android device: In the Wi-Fi settings screen, turn on Wi-Fi and select the network name that appears on the camcorder's screen (step 2). If necessary, enter the password that appears on the camcorder's screen.

- The camcorder's network name (SSID) should appear in the list of networks/access points detected by the device.
- As long as you do not reset the camcorder's Wi-Fi password, you only need to enter the password the first time you connect the device.
- When the Wi-Fi connection is correctly established, [Connected] will appear on the camcorder's screen. To save battery power, the camcorder's screen will turn off after about 1 minute.

4 iOS/Android device: Start the CameraAccess app.

- Use the app's onscreen controls to operate the camcorder while viewing the live image on the device.





When you have finished recording

1 Camcorder: Touch [End] to end the wireless connection and turn off the camcorder.

2 iOS/Android device: Close the CameraAccess app.





- While commands are being sent from the iOS/Android device to the camcorder (start/stop video recording, photo recording, field of view change), you may notice brief stops in the live view image displayed on the iOS/Android device.
- Using CameraAccess, the image is recorded exactly as it appears on the screen, regardless of the   [ Flip/Rotate Image]  [ Detect Orientation] setting.
- For details about the CameraAccess app, visit PIXELA's Web site.
<http://pixela.jp/ceca>
- Even if the frame rate was set to 24P, it will change automatically to 30P when using CameraAccess.

Remote Browse: Viewing Recordings Using a Web Browser on an iOS or Android Device

With the Remote Browse function, you can use the Web browser on any device equipped with a Wi-Fi receiver (iOS/Android devices, computers, etc.) to access the camcorder. You can then play back your recordings using the Web browser and even save local copies of them on your device*.



- * Depending on the device, OS, browser and video quality, you may not be able to play back or save recordings. For details, visit your local Canon Web site.

Shooting mode







Playback

- 1 Camcorder:** From any index screen, activate the Remote Browse mode.

➤ [Wi-Fi] ➤ [Playback via Browser] ➤ [OK]

- The camcorder's SSID (network name) and password will appear.
 - The camcorder will be ready to connect with the wireless device.
- 2 iOS/Android device:** In the Wi-Fi settings screen, turn on Wi-Fi and select the network name that appears on the camcorder's screen (step 1). If necessary, enter the password that appears on the camcorder's screen.
 - The camcorder's network name (SSID) should appear in the list of networks/access points detected by the device.
 - As long as you do not reset the camcorder's Wi-Fi password, you only need to enter the password the first time you connect the device.



- 3** iOS/Android device: Start the Web browser.
- 4** iOS/Android device: Enter the URL that appears on the camcorder's screen into the Web browser's address bar.
 - When the Wi-Fi connection is correctly established, the Remote Browse screen will appear.
 - The URL is always the same so you may find it convenient to bookmark the URL.
- 5** iOS/Android device: Touch the desired recording from the list.
 - For movies, the selected recording will start playing back. For photos, the photo will be displayed.
 - Interval scenes with the  icon will not be shown.
 - Touch  to return to the list of recordings.
 - Touch the button on the top left of the screen ( **MP4** or  ) to change the index screen displayed. Touch **MP4** to show movies or  to show photos.
 - Devices other than iOS devices: Touch  to save a local copy of the movie/photo on the device.

When you have finished

Camcorder: Touch [End]  [OK] to end the wireless connection and turn off the camcorder.





- Long scenes, whose video data exceeds 4 GB, will be recognized as multiple files on other devices.
- For details about Wi-Fi connections on computers and other devices, refer to the instruction manual of the OS, computer or device used.

Saving Recordings and Uploading Movies to the Web Using an iOS Device

Using the Movie Uploader app*, you can play back and save your movies and photos on an iOS device. You can also upload your movies to YouTube and Facebook even when you are away from your home network.

* The Movie Uploader app, provided by PIXELA, is available for free from the App Store.

Shooting mode

AUTO



P

Playback



- Before you perform this procedure for the first time, install the Movie Uploader app on your iOS device. The app can be downloaded for free from the following Web site.

<http://appstore.com/movieuploader>



- 1 Camcorder:** From any index screen, set the camcorder to connect with the iOS device.

 ➤ [(Wi-Fi)] ➤ [Movie Uploader] ➤ [OK]

- The camcorder's SSID (network name) and password will appear.
 - The camcorder will be ready to connect with the iOS device.
- 2 iOS device:** In the Wi-Fi settings screen, turn on Wi-Fi and select the network name that appears on the camcorder's screen (step 1). If necessary, enter the password that appears on the camcorder's screen.
 - The camcorder's network name (SSID) should appear in the list of networks/access points detected by the device.
 - As long as you do not reset the camcorder's Wi-Fi password, you only need to enter the password the first time you connect the device.
 - When the Wi-Fi connection is correctly established, [Connected] will appear on the camcorder's screen.



3 iOS device: Use the Movie Uploader app to upload the camcorder's movies.

- You can also play back or save movies and photos on the iOS device.
- Only movies can be uploaded to YouTube.

When you have finished

Camcorder: Touch [End]  [OK] to end the wireless connection and turn off the camcorder.



- Depending on factors such as the wireless network conditions, it can take some time to upload video files.
- The procedure above may differ depending on the version of iOS you are using.
- For details about the Movie Uploader app, visit PIXELA's Web site.
<http://www.pixela.co.jp/oem/canon/e/movieuploader/>
- Long scenes, whose video data exceeds 4 GB, will be recognized as multiple files on other devices.



Wireless Connections Using an Access Point

Sharing Recordings with CANON iMAGE GATEWAY

After you register for CANON iMAGE GATEWAY*, you will be able to access various Web services**. You will be able to upload movies and photos to online albums, share links to the albums on Twitter, upload movies to Facebook and YouTube, send links to your online albums by e-mail to friends and family, and more! To use this function, you will need an access point connected to the Internet.

* Availability differs from area to area.

** "Web services" is used in this text to refer to various Internet services supported by CANON iMAGE GATEWAY.



CANON iMAGE GATEWAY

CANON iMAGE GATEWAY is a Web site that provides various photo-related services for owners of qualified Canon products. After you complete the free registration online, you can use the Web services, create online photo albums, and more. Visit Canon's Web site for information on registration and countries/regions where you can use this service.
<http://canon.com/cig>



General requirements

- Computer with the supplied software **ImageBrowser EX** and **CameraWindow** correctly installed. For details on installing the software, refer to **Saving Recordings on a Computer** (📖 131).
- Completed free registration online for CANON iMAGE GATEWAY.
- Account settings for the services you plan to use (YouTube, Facebook, etc.). Available services may differ by country/region.



■ Setting the Desired Web Services in the Camcorder

Using the supplied software **CameraWindow**, log in to CANON iMAGE GATEWAY and set the Web services you want to use. Refer to 'CameraWindow User Guide' for details on using the software.



- 1** Camcorder: Open any index screen (📖 65, 72).
- 2** Connect the camcorder to the computer using the supplied USB cable.
 - Connection **2**. Refer to **Connection Diagrams** (📖 126).
- 3** Computer: Start **CameraWindow**.
 - Windows: If the AutoPlay dialog box appears, click Downloads Images From Canon Camera to open the main screen.
 - Mac OS: **CameraWindow** will automatically start and the main screen will appear.
- 4** Computer: Click **Camera Settings > Set Up Web Services**.



- 5 Computer:** Log in to CANON iMAGE GATEWAY and complete the setup process.
 - Follow the onscreen instructions to register the services you want to use. You will need the account information (user name, password, etc.) to register some services.
 - CANON iMAGE GATEWAY and all other selected Web services will be set in the camcorder and the **CameraWindow** menu screen will appear.
- 6 Computer:** Exit CameraWindow and then end the connection between the camcorder and computer.



- Available Web services differ depending on the country/region of use and may be updated from time to time. For the latest details about available services and terms of use, visit your local CANON iMAGE GATEWAY Web site.
- If the date set in the camcorder is not correct, the camcorder cannot connect to CANON iMAGE GATEWAY. Make sure the date is correct before trying to establish a connection.
- Once you have set the maximum number of Web services in the camcorder, you will not be able to set any additional services. Delete unnecessary Web services and then set the desired Web service.





- You cannot set multiple accounts for Web services other than e-mail.

■ Sharing Your Recordings Using Web Services

Conveniently share your recordings with family and friends using Web services.

Shooting mode

AUTO



Playback

- 1 From any index screen, set the camcorder to connect with the Web service.

➤ [Wi-Fi] ➤ [To Web Service] ➤ [OK]

- If you have previously configured and saved a connection to an access point, the camcorder will connect automatically to the last access point used.
- If no connections to access points have been saved in the camcorder, the message [Save the access point] will appear on the screen. Touch [OK] to configure and save a new access point connection (step 2 in **Wi-Fi Connection Using an Access Point** (📖 164) before continuing with this procedure.





2 Select the desired Web service.

- When you select  (e-mail), the list of registered e-mail addresses will appear. Select the e-mail addresses to which you want to send an e-mail notification.

3 Select whether you want to upload MP4 movies, photos or video snapshot scenes.

4 Touch the scene or photo(s) to upload.

- When uploading photos, you can touch up to 10 photos to upload at a time. To cancel the selection, touch [Remove All]  [Yes].
- Interval scenes with the  icon cannot be selected.
- If you are uploading to YouTube, read the YouTube agreement carefully and touch [I Agree] if you agree.
- The upload will begin automatically.
- You can touch [Stop] to cancel the wireless transfer while it is in progress.

5 Touch [OK].



Checking your uploads using CANON iMAGE GATEWAY Library

You can use the CANON iMAGE GATEWAY Library screen to see the movies and photos you uploaded. You can also check what files you have sent and the various settings for the Web services. For details on CANON iMAGE GATEWAY, refer to the Help module (in the upper right of the screen).



- **Upload limits for movies:** The maximum length of movies you can upload is 15 minutes; the maximum file size is less than 2 GB.
- For movies, you can upload one at a time; for photos, up to 10 at a time.
- Depending on the access point's (wireless router's) settings and capabilities, it can take some time to upload files.
- E-mail addresses must consist of single-byte characters. Only e-mail addresses with 16 or fewer characters before the @ mark can be set in the camcorder.



Wireless Playback on a Computer

Using the Media Server function, you can wirelessly view your movies and photos on your computer or similar device. You will need an access point connected to your home network and software installed on your computer that can play back movies and photos from a media server. We recommend that you connect the computer to the access point using a LAN cable. Refer also to the instruction manuals for the computer, software and access point.

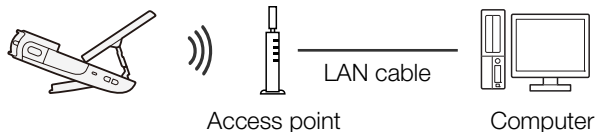

Shooting mode

AUTO



P

Playback



- 1** Camcorder: From any index screen, activate the media server function.

Home ➤ [Wi-Fi] ➤ [Media Server] ➤ [OK]



- If you have previously configured and saved a connection to an access point, the camcorder will connect automatically to the last access point used.
- If no connections to access points have been saved in the camcorder, the message [Save the access point] will appear on the screen. Touch [OK] to configure and save a new access point connection (step 2 in **Wi-Fi Connection Using an Access Point** (📖 164) before continuing with this procedure.

2 Camcorder: When the wireless connection is successfully established, [Connected] will appear on the camcorder's screen.

- You can touch [View Information] to view the access point's SSID, connection protocol, and the camcorder's IP address and MAC address.

3 Computer: Start your preferred media player software and select your camcorder's model name (Canon VIXIA mini) from the list of media servers.

- On standalone media players and other devices, connect the device to the home network and select your camcorder's model name from the list of media servers.

4 Computer: Play back the movies and photos.

- Interval scenes with the 📶 icon will not be shown.



5 Camcorder: Touch [End] ➤ [OK] when finished.



- Depending on the access point's (wireless router's) settings and capabilities, playback may take time to start or may not appear smooth. For details, refer to **Troubleshooting** (📖 207).

Wi-Fi Connection Using an Access Point

The camcorder can connect to a Wi-Fi network using an access point (wireless router) and even remember the settings for the 4 most recently used access points. When this is exceeded, the access point connection whose last-used date is the oldest will be replaced.

General requirements

- Correctly configured router that complies with the 802.11b/g/n protocol and is Wi-Fi certified (bears the logo shown below) and a home network.



Shooting mode

AUTO



P



Playback

- 1 From any index screen, open the [(📶) Network Setup] screen.

🏠 ➤ [(📶) Wi-Fi] ➤ [👉 Check/Edit Settings] ➤ [Access Point Connection Settings] ➤ [Not configured]

- 2 Touch the desired setup method.

- Depending on the setup method chosen, the procedure will be different. Read the descriptions below and continue with the procedure described in the relevant page.

Options

[WPS: Button]*

Simply press and hold the WPS button on your wireless router and then touch the camcorder's screen. This is the easiest connection method if you are using a WPS-compatible router. Continue the procedure as described in **Wi-Fi Protected Setup (WPS)** (📖 166).



[WPS: PIN Code]*

Access the access point's configuration screen using your Web browser. The camcorder will give you a PIN code, which you will enter into the browser. You will need a WPS-compatible router and a computer or other device connected to it. Continue the procedure as described in **Wi-Fi Protected Setup (WPS)** (📖 166).

[Search for Access Points]

Following the camcorder's onscreen instructions, you select the desired access point from a list and then enter your password. Continue the procedure as described in **Searching for Access Points** (📖 168)

[Manual Setup]

You manually enter the access point's name, password and other network settings. This method is recommended only for advanced users of Wi-Fi networks. Continue the procedure as described in **Manual Setup** (📖 171).

- * WPS, which stands for Wi-Fi Protected Setup, is a standard that makes connecting to an access point easier.



■ Wi-Fi Protected Setup (WPS)

If your access point is WPS-compatible (bears the logo shown below), connecting the camcorder to it can be very easy. If you cannot successfully connect the camcorder using WPS, try using the [Search for Access Points] method. Refer also to the router's instruction manual.



1 [WPS: Button] method

- Press and hold the WPS button on the wireless router.
- Depending on the router, the amount of time required may differ.
- Make sure the router's WPS function is activated.

[WPS: PIN Code] method

- From a computer or similar device connected to the access point, use the Web browser to open the router's WPS settings screen. After the 8-digit PIN code appears on the camcorder's screen, enter it into your router's WPS settings screen.



2 Within 2 minutes, touch [OK] on the camcorder's screen.

- The camcorder will connect to the access point.
- You can touch [Stop] and then [OK] to interrupt the Wi-Fi Protected Setup while it is in progress.
- When the Wi-Fi Protected Setup is finished, [Configuration completed] will appear on the screen.

3 Touch [OK] to save the configuration.

- If you were in the process of performing another procedure, the camcorder will automatically connect to the access point. Return to the procedure of the function you were previously using:

Step 2 in **Sharing Your Recordings Using Web Services** (📖 159); Step 2 in **Wireless Playback on a Computer** (📖 162).

- Otherwise, touch [↶] ➤ [X] to close the menu.



■ Searching for Access Points

After you touch [Search for Access Points], the camcorder will take a few seconds to detect access points available in the vicinity and will display the first one. Make a note in advance of the network name (SSID) and password (encryption key) of the access point you want to use. (This will usually be the wireless router on your home network.)

To enter text for the various settings, use the virtual keyboard (📖 170).

1 Select the desired access point.

- If the desired access point is not displayed, you can touch [▲] or [▼] to go through the list of detected access points. You can also touch [Search Again] to have the camcorder search for access points again.
- When the network name (SSID) of the desired access point appears, touch [OK].

2 To enter the [Encryption Key] field, touch [Not configured]. Enter the access point's password (encryption key) and touch [OK].

- If the access point selected in step 1 did not have a [🔒] icon, this step is not necessary.



3 Touch [OK] to save the configuration.

- If you were in the process of performing another procedure, the camcorder will automatically connect to the access point. Return to the procedure of the function you were previously using:

Step 2 in **Sharing Your Recordings Using Web Services** (📖 159); Step 2 in **Wireless Playback on a Computer** (📖 162).

- Otherwise, touch [↶] ➤ [X] to close the menu.



Using the virtual keyboard

When you need to enter text for various settings, touch the text field and a virtual keyboard will appear on the screen. The illustration below explains the various keys you can use.

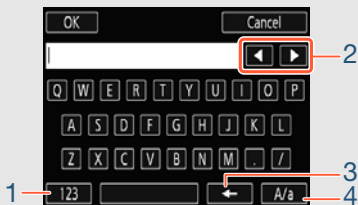

- 1 Switch between letters and numbers/special characters.
- 2 Change the position of the cursor.
- 3 Delete the character to the cursor's left (backspace).
- 4 Caps Lock. When the numerical keyboard is displayed, [#%?] switches between set 1 and set 2 of special characters.



■ Manual Setup

Perform this procedure to manually configure the wireless connection settings. This may be necessary, for example, if your access point's network name (SSID) cannot be detected due to the stealth function being enabled. Manual setup is for advanced users of Wi-Fi networks.

To enter text for the various settings, use the virtual keyboard ( 170).

- 1** In the [SSID] field, enter the SSID. Touch [OK] and then touch [Next].
- 2** In the [Authentication/Encryption Method] field, touch [OPEN NONE] and then touch the desired method.
 - If you selected [OPEN WEP], the WEP index is 1.
- 3** In the [Encryption Key] field, enter the encryption key. Touch [OK] and then touch [Next].
 - If you selected [OPEN NONE] in step 2, this step is not necessary.
- 4** Touch [Automatic] or [Manual] to select how to obtain the IP address.
 - If you selected [Automatic], proceed to step 9.



- 5** To enter the [IP Address] field, touch [0.0.0.0]. Touch the first field and touch [▲]/[▼] to change the value. Change the rest of the fields in the same way and touch [OK].
- 6** Enter the [Subnet Mask] field in the same way and touch [Next].
- 7** Enter the [Default Gateway] field in the same way and touch [Next].
- 8** Enter the [Primary DNS Server] and [Secondary DNS Server] fields in the same way and touch [Next].
- 9** Touch [OK] to save the configuration.
 - If you were in the process of performing another procedure, the camcorder will automatically connect to the access point. Return to the procedure of the function you were previously using:
Step 2 in **Sharing Your Recordings Using Web Services** (📖 159); Step 2 in **Wireless Playback on a Computer** (📖 162).
 - Otherwise, touch [↩] ➤ [X] to close the menu.





- The Wi-Fi functions available and the setup method will vary depending on the specifications and characteristics of the Wi-Fi network you want to use.

Viewing and Changing Wi-Fi Settings

When the camcorder is connected to an access point or to a Wi-Fi-enabled device, you can view the Wi-Fi connection settings and even change them, if necessary.



- 1 From any index screen, open the [Check Current Configuration] screen.

Home ➤ [Wi-Fi] ➤ [Check/Edit Settings] ➤ [OK]

To view the connection settings for iOS/Android devices

- 1 Touch [Smartphone Connection Settings].
 - The camcorder's SSID and password will appear.
- 2 If necessary, change the camcorder's network name (SSID) and password.



[Edit] ➤ [OK] ➤ [OK]

- The next time you make a wireless connection, you will need to change the Wi-Fi settings on the iOS/Android device.

3 Touch [↶] ➤ [✕] to close the menu.

To view the access point's connection settings

1 Touch [Access Point Connection Settings].

- The 4 access points' SSID settings in the camcorder's memory will appear.
- If there are available connection slots, you can touch [Not configured] to set up a new access point (📖 163).

2 Touch the SSID of the access point whose settings you want to view.

- The access point's settings will appear.
- Touch [▲] and [▼] to view more information.
- To delete the access point connection displayed, touch [Edit] ➤ [Delete] ➤ [Yes].
- To manually change the settings of the access point connection displayed, touch [Edit] ➤ [Manual Setup] and then perform the procedure in **Manual Setup** (📖 171).
- Touch [↶] to return to the access point selection screen.



- 3** Touch []  [] to close the menu.

Glossary

This is a glossary of some of the basic terms used frequently in this chapter. The documentation for your access point may also contain a glossary you can refer to.

Access Point

A wireless access point (WAP) is a device that allows wireless devices, like your camcorder, to connect to a wired network (including to the Internet) using the Wi-Fi standard. In most cases, this will be your wireless router.

IP Address

Exclusive number assigned to each device connected to the network.

SSID

Service Set Identifier. This is simply the public name of a Wi-Fi network.

WPS

Wi-Fi Protected Setup. Standard for easy and secure setup of Wi-Fi networks created by the Wi-Fi Alliance.





Additional Information

178

Appendix: Menu Options Lists

This section contains tables of all the camcorder's menu settings and setting options for your reference.

192

Appendix: Onscreen Icons and Displays

This section explains the icons and displays that appear on the camcorder's various screens, with reference pages to the relevant functions.

199

Trouble?

Consult the troubleshooting advice and list of messages when you are experiencing some trouble with your camcorder.

226

Do's and Don'ts

This section contains important handling precautions and maintenance instructions.



General Information

This section contains information about optional accessories that can be used with the camcorder and ends with the comprehensive list of technical specifications.



Appendix: Menu Options Lists

The functions that are available depend on the camcorder's operating mode. On the camcorder's screen, menu items not available appear grayed out. For details about how to select an item, refer to **Using the Menu** (📖 45). For details about each function, see the reference page. Menu options without a reference page are explained after the tables. Menu options in blue and bold type, **like this**, indicate default values.

🏠 (Home) Menu

Menu item

Setting options

[🔧 Other Settings] (📖 50, 180)

[Audio Scene] (📖 110)

[**STD Standard**], [🎵 Music], [🗣️ Speech],
[🌳 Forest and Birds], [🚗 Noise Suppression]

[Special Rec Modes] (📖 94, 98, 100)

[**Normal Recording**], [🕒 Interval Recording],
[📏 Slow Motion], [📏 Fast Motion], [📸 Video Snapshot]



🏠 (Home) Menu (cont.)

Menu item	Setting options
[Shooting Mode]	(📖 90) [AUTO Auto], [🍴 Food and Fashion], [🏃 Sports], [🌃 Night Scene], [🏖 Beach], [❄ Snow], [🌸 Macro], [P Programmed AE]
[📷 Flip/Rotate Image]	(📖 108) [🔄 Mirror Image]: [On], [Off] [📷 Detect Orientation]: [On], [Off]
[🕒 Self Timer]	(📖 102) [OFF Off], [2sec 2 sec], [10sec 10 sec]
[📱 Remote Control+Streaming]	(📖 145)
[📺 Photo Playback]	(📖 72)
[📺 Movie Playback]	(📖 65)
[🎵 Video Snapshot]	(📖 65)
[📶 Wi-Fi]	(📖 138) [📺 Movie Uploader], [🌐 Playback via Browser], [🌐 To Web Service], [🖨 Media Server], [🖱 Check/Edit Settings]



[Edit] Functions in Playback Modes

Button

Setting options

[Convert to MP4] (📖 128)

[Delete] (📖 76, 81)

[🎬] or [🎵] index screen: <folder name>, [Select],
[All Scenes]

[📷] index screen: <folder name>, [Select], [All Photos]

During playback pause: [This Scene]

In single photo view: [🗑️ Proceed] (deletes the current photo)

[Trim] (📖 79)

[⚙️] Other Settings] Menus

[📷] Camera Setup (recording mode only)

Menu item

Setting options

[Video Quality] (📖 87)





[**24Mbps** High Quality 24 Mbps],

[**17Mbps Standard (Full HD) 17 Mbps],**

[**4Mbps** Long Play 4 Mbps]



 **Camera Setup (recording mode only) (cont.)**



Menu item	Setting options
[Frame Rate]	– [30P 30P], [24P 24P]
[Face Detection & Tracking]	( 117) [ON On ], [OFF Off]
[Auto Backlight Correction]	– [ON On], [OFF Off]
[Flicker Reduction]	– [OFF Off], [50Hz 50 Hz], [60Hz 60 Hz]
[Video Snapshot Length]	( 100, 120) [2sec 2 sec], [4sec 4 sec], [8sec 8 sec]
[Photo Size]	( 89) [L 4000x3000], [M 1920x1440], [S 640x480]
[Photo Review Time]	– [OFF Off], [2sec 2 sec], [4sec 4 sec], [6sec 6 sec], [8sec 8 sec], [10sec 10 sec]



[Frame Rate]: Sets the frame rate (the number of frames recorded per second). Changing the frame rate will change how smooth movement looks in your movies. You can select 30P (30 frames per second, progressive) or a cinema-like 24P (24 frames per second, progressive).

- The frame rate cannot be changed when the shooting mode is set to **AUTO**.

[Auto Backlight Correction]: The camcorder automatically corrects for backlight when shooting subjects with a strong light behind them.

- This function is not available when the shooting mode is set to ,  or .

[Flicker Reduction]: If the screen starts to flicker when recording movies under fluorescent lights, change the setting to reduce the effect.

- This function is only available when the shooting mode is set to **P**.

[Photo Review Time]: Selects the time to display a photo after it is recorded.



 /  **Playback Setup (playback mode only)**

Menu item

Setting options

[Video Snapshot Length] (📖 100, 120)



[**2sec** 2 sec], [**4sec** 4 sec], [**8sec** 8 sec]

[Slideshow Transition] (📖 84)

[**OFF** Off], [ Dissolve], [ Slide Image]

[Auto Rotate] —

[**ON** On], [**OFF** Off]

[Auto Rotate]: When set to [**ON** On], the camcorder will display in the correct orientation photos that were recorded with the camcorder held vertically, if at the time of recording   [ Detect Orientation] was set to [On].









 **Display Setup**

Menu item

Setting options

[Onscreen Markers] —

[**OFF** Off], [ **W** 16:9 (White)], [ **G** 16:9 (Gray)],
 [ **W** Level (White)], [ **G** Level (Gray)],
 [ **W** Grid (White)], [ **G** Grid (Gray)]

[Display Date/Time] —

[**ON** On], [**OFF** Off]

[Output Onscreen Displays] —

[**ON** On], [**OFF** Off]

[LCD Brightness] —



[LCD Backlight] —

[**H** Bright], [**M Normal**], [**L** Dim]

[HDMI Status] —

[Demo Mode] —

[**ON** On], [**OFF** Off]

[Onscreen Markers] (recording mode only): You can display 16:9 area markers, a grid, or a horizontal line at the center of the screen. Use the markers as a reference to make sure your subject is framed correctly (vertically and/or horizontally).

- Movies have a 16:9 aspect ratio, so the 16:9 marker can be used as a convenient reference to check the area that will be recorded.
- Using the onscreen markers will not affect the recordings.

[Display Date/Time] (playback mode only): Select whether to display the recording date and time during playback.

- During photo playback, both the date and time are displayed. During movie playback, only the date is displayed.

[Output Onscreen Displays] (playback mode only): When set to [**ON** On], the camcorder's onscreen displays will appear also on the screen of a TV or monitor connected to the camcorder.

[LCD Brightness]: Adjusts the brightness of the LCD screen.

- Changing the brightness of the LCD screen does not affect the brightness of your recordings or the brightness of the playback image on a TV.

[LCD Backlight]: Sets the screen to one of three brightness levels. You can use this to make the screen brighter when recording in bright places, for example.



- Changing the brightness of the LCD screen does not affect the brightness of your recordings or the brightness of the playback image on a TV.
- Using the [**H Bright**] setting will shorten the effective usage time of the battery pack.

[HDMI Status] (playback mode only): Displays a screen where you can verify the standard of the output signal from the HDMI terminal.

[Demo Mode]: The demonstration mode displays the camcorder's main features. It starts automatically when the camcorder is powered using the optional CA-110 Compact Power Adapter if you leave it in record standby mode without a memory card for more than 5 minutes.

- To cancel the demo mode once it has started, press any button or turn off the camcorder.



 **System Setup**



Menu item

Setting options

[Language ] (38)

[Česky], [Dansk], [Deutsch], [Ελληνικά], [**English**], [Español], [Français], [Italiano], [Magyar], [Melayu], [Nederlands], [Norsk], [Polski], [Português], [Română], [Suomi], [Svenska], [Türkçe], [Русский], [Українська], [العربية], [فارسی], [ภาษาไทย], [简体中文], [繁體中文], [한국어], [日本語]

[Time Zone/DST] (41)

[] (home time zone) or [] (travel time zone):[**New York**], list of world time zones[] (DST adjustment): Toggle on or **off**

[Date/Time] (38)

[Date/Time]: –

[Date Format]: [Y.M.D], [**M.D,Y**], [D.M.Y] (Y- year, M- month, D- day)[24H]: Toggle on (24-hour clock) or **off (12-hour clock)**









[Available Space in Memory] –

[Used Space in Memory] –

[Volume] (67)



 **System Setup (cont.)**

Menu item	Setting options
[Notification Sounds]	–  High Volume ,  Low Volume], [OFF Off]
[File Numbering]	–  Reset], [ Continuous]
[Auto Power Off]	–  On], [OFF Off]
[SP-V1 Mode]	–  On], [OFF Off]
[Initialize 	– ( 42) [Complete Initialization]: Toggle on or off
[Firmware]	–
[Certification Logo Display]	–
[Reset All]	– [No], [Yes]



[Available Space in Memory] (recording mode only)/

[Used Space in Memory] (playback mode only): Displays a screen where you can verify how much of the memory card is currently available for recording or how much is in use ( indicates photos).

- Estimated figures about available movie recording time and available number of photos are approximate and based on the currently selected video quality and photo size.
- The information screen displays also the Speed Class rating of the memory card.

[Notification Sounds]: A beep will accompany some operations like turning on the camcorder, the self-timer countdown, etc.

- Set to [**OFF** Off] to turn off notification sounds.

[File Numbering]: Movies and photos are saved on the memory card as files in folders, which are assigned consecutive file numbers. This setting determines how files are numbered.

 **Reset]:** File numbers will restart from 100-0001 every time you record on a memory card that has been initialized.

 **Continuous]:** File numbers will continue from the number following that of the last file recorded with the camcorder.

- If the memory card you insert already contains a file with a larger number, a new file will be assigned a number one higher than that of the last file on the memory card.



- We recommend using the [ Continuous] setting.
- Folders can contain up to 500 files (movies and photos combined).
- File numbers consist of 7 digits, for example “101-0107”. The 3 digits before the hyphen indicate the folder where the file is saved and can range from 100 to 999. The 4 digits after the hyphen are a unique identifier for each file and can range from 0001 to 9900.
- The last four digits of the folder name indicate the date when the folder was created.
- The file number and folder name also indicate the location of the file on the memory card. A recording with the file number “101-0107”, made on 3 November will be found in the folder DCIM\101_1103. If it is a movie, its file name will be MVI_0107.MP4; if it is a photo, its file name will be IMG_0107.JPG.
- All the interval scenes recorded during one interval recording sequence are saved in separate folders indicated by the letter “I” instead of an underscore (ex. “101I0501”).

[Auto Power Off]: In order to save power when the camcorder is powered by a battery pack, it will automatically shut off if left without any operation for 3 minutes.



- Approximately 30 seconds before the camcorder shuts off, [Auto Power Off] will appear. Operating any of the camcorder's controls while the message is displayed will prevent the camcorder from shutting off.

[SP-V1 Mode]: Activates an alternative operation mode that allows the camcorder to be used when it is protected by the optional SP-V1 Splashproof Case. Functions available in this mode are limited. For details, refer to the instruction manual of the SP-V1.

[Firmware] (playback mode only): You can verify the current version of the camcorder's firmware, which is the software that controls the camcorder. This menu option is usually unavailable.

[Certification Logo Display]: This displays select certification logos that apply to this camcorder.

- The certification logos apply to Canada only.

[Reset All]: Resets all of the camcorder's settings, including any stored access point connections, passwords and other Wi-Fi settings.







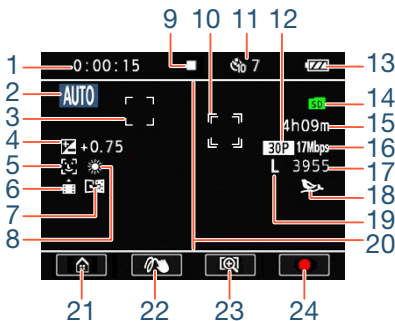



















Appendix: Onscreen Icons and Displays

Recording



- 1 Scene counter (hours : minutes : seconds, only while recording)
- 2 Shooting mode button (📖 90)
In **AUTO** mode: Smart AUTO (📖 58)
- 3 Face detection frame (📖 117)
- 4 Exposure compensation (📖 114)
- 5 Face detection (📖 117)
- 6 Orientation detection (📖 108)







- 7 Mirror image recording ( 108)
- 8 White balance ( 112)
- 9 Memory card operation ( 198)
- 10 User-selected main subject frame ( 117)
- 11 Self timer and countdown ( 102)
- 12 Frame rate ( 182)
- 13 Remaining battery charge ( 198)
- 14 Memory card
- 15 Remaining video recording time ( 198)
- 16 Video quality ( 87)
- 17 Remaining available number of photos ( 198)
- 18 Audio scene ( 110)
- 19 Photo size ( 89)
- 20 16:9 area marker ( 185)
- 21 [] button: Open the  (Home) menu ( 46)
- 22 [] button: Decoration ( 103)
- 23 [] / [] button: Change the field of view ( 57)
- 24 []/[] button: Start/Stop recording a movie ( 54)

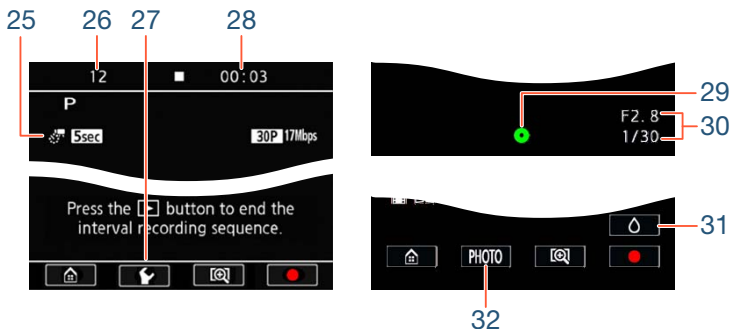

Recording Photos and Special Recording Modes



25 Special recording modes

-  - Interval recording and selected interval (📖 94)
-  - Slow motion and selected speed (📖 98)
-  - Fast motion and selected speed (📖 98)
-  - Video snapshot and selected video snapshot length (📖 100)

26 During interval recording: Number of recordings made so far (📖 94)

27 [P] button

During slow/fast motion: Speed selection (📖 98);
 During interval recording: Interval length selection (📖 94)

28 During interval recording: Time left until the next recording (📖 94)



Only while recording photos (61)

29 Exposure locked

30 Aperture value and shutter speed

Only when [SP-V1 Mode] is set to [**ON** On] (191)

31 [] button: Cancel the splashproof case mode

32 [PHOTO] button: Record a photo when the camcorder is in the splashproof case



Playing Movies (during playback)

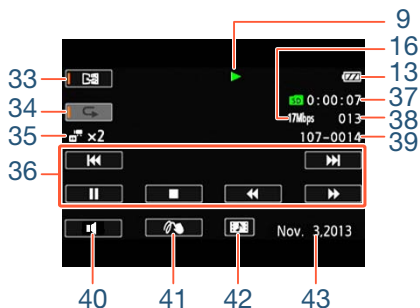

33 Mirror image playback (📖 69)

34 Repeat playback (📖 69)

35 Slow/Fast motion and playback speed (📖 98)

🌟 - Interval scenes that have not yet been joined (📖 94)

36 Playback control buttons (📖 67)

37 Scene playback time

38 Scene number

39 File number (📖 189)

40 [🔊] button: Volume (📖 67)

41 [👋] button: Decoration (📖 107)

42 [📷] button: Capture a video snapshot scene (📖 120)

43 Recording date (📖 185)



Viewing Photos

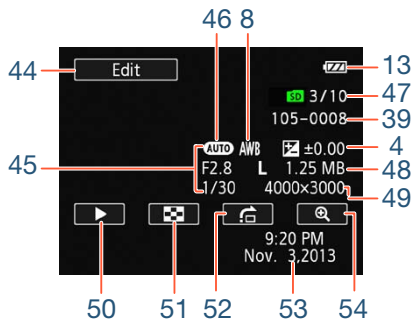

- 44 [Edit] button: Open the [Edit] panel (📖 180)
- 45 Shooting information
- 46 Shooting mode (📖 90)
- 47 Current photo / Total number of photos
- 48 File size
- 49 Photo size (📖 89)
- 50 [▶] button: Slideshow (📖 84)
- 51 [🎞️] button: Return to the [📷] index screen (📖 72)
- 52 [🏠] button: Photo jump (📖 74)
- 53 Recording date and time (📖 185)
- 54 [🔍] button: Magnified playback (📖 74)



9 Memory card operation

● Record, ■ Record standby, ► Playback, || Playback pause, ►► Fast playback, ◀◀ Fast reverse playback, |► Slow playback, ◀| Slow reverse playback, ||► Frame advance, ◀|| Frame reverse.

13 Remaining battery charge



- The icon shows a rough estimate of the remaining charge of the battery pack.
- When the battery charge becomes low, replace or charge the battery pack. Depending on the condition of the camcorder or battery, the actual battery charge may not match what is displayed on the screen.
- When you insert an empty battery pack, the power may turn off without displaying .

15 Remaining video recording time

When there is no more free space on the memory card,  and [End] will be displayed (in red) on the screen and the recording will stop.

17 Remaining available number of photos

Even if the remaining number of photos that can be recorded is larger, the maximum number displayed on this screen is [9999].



Troubleshooting

If you have a problem with your camcorder, refer to this section. Sometimes what you think is a malfunction of the camcorder may have the simplest of solutions - please read the “CHECK THIS FIRST” box before going on to the more detailed problems and solutions. Consult your dealer or a Canon Service Center if the problem persists.

CHECK THIS FIRST

Power supply

- Is the battery charged?

Recording

- Did you turn the camcorder on and correctly set it to recording mode? (📖 54, 61) Is a compatible memory card correctly inserted into the camcorder? (📖 36)

Playback

- Did you turn the camcorder on and correctly set it to playback mode? (📖 65, 72) Is a compatible memory card correctly inserted into the camcorder? (📖 36) Does it contain any recordings?



Power Source

The camcorder will not turn on or it turns off by itself.

- The battery pack is exhausted. Replace or charge the battery pack.
- Remove the battery pack and insert it correctly.

Cannot charge the battery pack.

- The temperature of the battery pack is outside its operating range (approximately 0 – 40 °C (32 – 104 °F)). Remove the battery pack, warm it or let it cool down, as necessary, and try charging it again.
- Charge the battery pack in temperatures between approximately 0 °C and 40 °C (32 °F and 104 °F).
- If you are using a battery pack recommended by Canon for use with this camcorder, there may be a problem with the battery pack. Consult a Canon Service Center.
- Battery packs cannot be charged with the camcorder even when it is powered using the optional CA-110 Compact Power Adapter.





The battery pack is exhausted extremely quickly even at normal temperatures.

- The battery may have reached the end of its battery life. Buy a new battery pack.



Recording

Touching [●] will not start recording.

- You cannot record while the camcorder is writing previous recordings onto the memory card (while the ACCESS indicator is on or flashing). Wait until the camcorder has finished.
- The memory card is full. Delete some recordings (📖 76, 81) or initialize the memory card (📖 42) to free some space.
- The folder and file numbers for movies and photos have reached their maximum value. Set     [File Numbering] to [Reset] and insert a new memory card.

The point where [●] or [■] was touched does not match the beginning/end of the recording.

- There is a slight interval between touching the button and the actual start/end of recording. This is not a malfunction.

When a subject flits across in front of the lens, the image appears slightly bent.

- This is a phenomenon typical of CMOS image sensors. When a subject crosses very quickly in front of the camcorder, the image may seem slightly warped. This is not a malfunction.



Changing the operating mode between recording (●)/recording standby (■)/playback (▶) takes longer than usual.

- When the memory card contains a large number of scenes, some operations may take longer than usual. Save your recordings (📖 131) and initialize the memory card (📖 42).

Movies or photos cannot be recorded properly.

- This may occur as movies and photos are recorded/deleted over time. Save your recordings (📖 131) and initialize the memory card using the [Complete Initialization] option (📖 42).

After using the camcorder for a long time, it becomes hot.

- The camcorder may become hot after using it continuously for long periods of time; this is not a malfunction. If the camcorder becomes unusually hot or it becomes hot after using it only for a short while, it may indicate a problem with the camcorder. Consult a Canon Service Center.

Playback

Cannot delete a scene.

- You may not be able to delete scenes recorded or edited using another device.



Deleting scenes takes longer than usual.

- When the memory card contains a large number of scenes, some operations may take longer than usual. Save your recordings (📖 131) and initialize the memory card (📖 42).

Cannot capture a video snapshot scene from a movie.

- You cannot capture video snapshot scenes from scenes recorded or edited using another device.
- The memory card is full. Delete some recordings (📖 76, 81) to free some space.

Cannot mark individual scenes/photos in the index screen with a checkmark ✓

- You cannot select more than 100 scenes/photos individually. Select the [All Scenes] or [All Photos] option instead of [Select].

Indicators and Onscreen Displays

or appears (in red) on the screen.

- Battery pack is exhausted. Replace the battery pack with a fully charged one.

or appears (in red) on the screen and the camcorder cannot be turned off and on.

- Battery pack is exhausted. Replace the battery pack with a fully charged one.











Trouble?

 appears (in red) on the screen.

- A memory card error occurred. Turn off the camcorder. Remove and reinsert the memory card. Initialize the memory card if the display does not change back to normal.

 and [End] appear (in red) on the screen.





- The memory card is full. Replace the memory card or delete some recordings ( 76, 81) to free some space on the memory card.
- The folder and file numbers have reached their maximum value. Set     [File Numbering] to [Reset] and delete all the movies ( 76) and photos ( 81) on the memory card or initialize it ( 42).

Even after stopping recording, the ACCESS indicator does not go off.

- The scene is being recorded on the memory card. This is not a malfunction.

Picture and Sound

The screen appears too dark.

- The LCD screen was dimmed. Change the     [LCD Backlight] setting to [Normal] or [Bright].

Screen displays turn on and off repeatedly.

- The battery pack is exhausted. Replace or charge the battery pack.



Trouble?

- Remove the battery pack and insert it correctly.





Abnormal characters appear on the screen and the camcorder does not operate properly.

- Remove the battery pack and insert it after a few moments.

Video noise appears on screen.

- Keep a distance between the camcorder and devices that emit strong electromagnetic fields (plasma TVs, cellular phones, etc.).

Horizontal bands appear on the screen.

- This is a phenomenon typical of CMOS image sensors when recording under some types of fluorescent, mercury or sodium lamps. This is not a malfunction. To reduce the symptoms, change the     [Flicker Reduction] setting.

Sound is distorted or is recorded at lower levels.

- When recording near loud sounds (such as fireworks, shows or concerts), sound may become distorted or it may not be recorded at the actual levels. This is not a malfunction.

The picture is displayed correctly but there is no sound from the built-in speaker.

- Speaker volume is turned off. Adjust the volume ( 67).
- If the optional HTC-100 High Speed HDMI Cable is connected to the camcorder, disconnect it.







Memory Card and Accessories

Cannot insert the memory card.

- The memory card was not facing the correct direction. Turn the memory card over and insert it.

Cannot record on the memory card.

- The memory card is full. Delete some recordings (📖 76, 81) to free some space or replace the memory card.
- Initialize the memory card using the [Complete Initialization] option (📖 42) when you use it with the camcorder for the first time.
- A compatible memory card must be used to be able to record movies on a memory card (📖 34).
- The folder and file numbers for movies and photos have reached their maximum value. Set     [File Numbering] to [Reset] and insert a new memory card.

Connections with External Devices

There is no image on the TV screen and there is no sound.

- The video input on the TV is not set to the video terminal to which you connected the camcorder. Select the correct video input.
- Disconnect the optional HTC-100 High Speed HDMI cable and then restore the connection or turn the camcorder off and then on again.



Trouble?

- The camcorder may be set to recording mode. Disconnect the optional HTC-100 High Speed HDMI cable, set the camcorder to playback mode and then restore the connection.
- Video and audio will not be output from the camcorder while Wi-Fi functions are in use.

The computer does not recognize the camcorder even though the camcorder is connected correctly.

- Disconnect the USB cable and turn off the camcorder. After a short while, turn it on again and restore the connection.
- Connect the camcorder to a different USB port on the computer.

Cannot save recordings on my computer

- When the memory card contains too many recordings (Windows – 2,500 photos/movies or more, Mac OS – 1,000 photos/movies or more), you may not be able to transfer recordings to a computer. Try using a card reader.

Wi-Fi Functions

Refer also to the instruction manual of your access point and other devices you will use.

Cannot connect with the access point.

- Check that the access point is working correctly.



Trouble?

- The effective communication range between the camcorder and access point may vary depending on the strength of the wireless signal. Try using the camcorder closer to the access point.
- Cordless phones, microwave ovens, refrigerators and other appliances in the line of sight between the access point and the camcorder may interfere with the wireless signal. Try using the camcorder in a location farther away from such appliances.
- Wi-Fi networks with a stealth function that do not broadcast their network name (SSID) will not be detected by the camcorder during the Wi-Fi network setup. Perform the setup manually (📖 171) or turn off the stealth function of the access point.

Wireless playback on a computer or similar device is not smooth.

- Playback may not be smooth depending on the access point's settings and capabilities.
- Connect the computer to the access point using a LAN cable.
- Remove any objects between the camcorder and wireless access point that may interfere with the wireless signal.
- Move the camcorder closer to the wireless access point.
- Turn off the wireless functions of other wireless devices other than the computer or similar device being used for playback.







Trouble?

- Switch the wireless access point to IEEE 802.11n. Refer to its instruction manual for details.
- If these do not solve the issue, the cause may be due the device or conditions unique to the surrounding area. Use the optional HTC-100 High Speed HDMI cable to connect the camcorder to a TV (📖 127).

The wireless connection was interrupted while transferring files.

- Incomplete files may remain at the transfer destination. If incomplete files remain at the transfer destination, check the content and make sure they are safe to delete before deleting them.
- Select [New Files] and perform the file transfer again.

Cannot complete a wireless connection to the camcorder.

- Resetting the camcorder's settings using     [Reset All] will reset the camcorder's SSID (network name) and change the network passwords. Erase the camcorder's previous network settings from the iOS or Android device and connect the device to the camcorder again.

The Remote Browse screen does not appear correctly on the Web browser.

- The device, operating system or Web browser used may not be supported. For the latest information about supported systems, visit your local Canon Web site.



- Enable JavaScript and cookies in your Web browser's settings. For details, refer to the help modules or online documentation of the Web browser used.

List of Messages (in alphabetical order)

Refer to **List of Messages for Wi-Fi Functions** (📖 218) for a list of messages related to general Wi-Fi functions, and **List of Messages for Web Services** (📖 223) for messages related to Web services when using CANON IMAGE GATEWAY.

Back up recordings regularly

- This message may appear when you turn on the camcorder. In the event of a malfunction, recordings may be lost so back up your recordings regularly.

Cannot convert scenes recorded using interval recording.

- Interval scenes with the  icon cannot be converted or resized. Join the interval scenes into a single scene (📖 96).

Cannot convert the scene

- Scenes that were recorded or edited with other devices cannot be converted to MP4 scenes.

Cannot join 24P and 30P scenes to convert them

- Scenes that were recorded using different frame rates cannot be joined to a single scene when converted or resized.





Cannot load canvas

- The canvas file that was saved on the memory card is corrupted.
- Canvas data cannot be read from canvas files created using other devices.

Cannot play back

- You may not be able to play back scenes that were recorded with other devices or created or edited on a computer.
- There is a problem with the memory card. If this message appears often without apparent reason, contact a Canon Service Center.

Cannot play back Check the memory card

- There is a problem with the memory card. Save your recordings ( 131) and initialize the memory card using the [Complete Initialization] option ( 42). If the problem persists, use a different memory card.

Cannot play the movies on this memory card

- Movies cannot be played back from a 64 MB or smaller memory card. Use a recommended memory card ( 34).



Cannot play the movies on this memory card Initialize only using the camcorder

- The memory card in the camcorder was initialized using a computer. Initialize the memory card with this camcorder (📖 42).

Cannot record

- You cannot capture video snapshot scenes from scenes recorded or edited using another device.
- There is a problem with the memory card. If this message appears often without apparent reason, contact a Canon Service Center.

Cannot record Check the memory card

- There is a problem with the memory card. Save your recordings (📖 131) and initialize the memory card using the [Complete Initialization] option (📖 42). If the problem persists, use a different memory card.

Cannot record movies on this memory card

- Movies cannot be recorded on a 64 MB or smaller memory card. Use a recommended memory card (📖 34).

Cannot record movies on this memory card Initialize only using the camcorder

- The memory card in the camcorder was initialized using a computer. Initialize the memory card with this camcorder (📖 42).



Cannot save the canvas

- Cannot save your [Pens and Stamps] drawings on the memory card. Save your recordings (📖 131) and initialize the memory card (📖 42).



Cannot trim the scene

- Scenes that were recorded or edited with other devices cannot be trimmed with this camcorder.

Charge the battery pack







- Battery pack is exhausted. Charge the battery pack.

Check the memory card

- Cannot access the memory card. Check the memory card and make sure it is inserted correctly.
- A memory card error occurred. The camcorder cannot record or display the image. Try removing and reinserting the memory card, or use a different memory card.
- If after the message disappears,  appears in red, perform the following: Turn off the camcorder and remove and reinsert the memory card. If  turns back to green you can resume recording/playback. If the problem persists, save your recordings (📖 131) and initialize the memory card (📖 42).



File name error

- The folder and file numbers have reached their maximum value. Set     [File Numbering] to [Reset] and delete all the movies ( 76) and photos ( 81) on the memory card or initialize it ( 42).

Initialize only using the camcorder

- There is a problem with the file system that prevents accessing the memory card. Initialize the memory card with this camcorder ( 42).

LCD Screen has been dimmed Use the [LCD Backlight] setting to change the brightness

- Change the     [LCD Backlight] setting to [Normal] or [Bright].

May not be possible to record movies on this memory card

- You may not be able to record movies on a memory card without a Speed Class rating or with one rated SD Speed Class 2, 4 or 6. Replace the memory card with one rated SD Speed Class 10.

Memory card is full

- The memory card is full. Delete some recordings ( 76, 81) to free some space or replace the memory card.



Memory card writing error Attempt to recover the data?

- This message will appear the next time you turn on the camcorder if power supply was accidentally interrupted while the camcorder was writing to the memory card. Select [Recover] to try to recover the recordings. If you inserted a memory card that contains scenes recorded using another device, we recommend that you select [No].

No memory card

- Insert a compatible memory card into the camcorder (📖 36).
- The memory card may not be inserted correctly. Insert the memory card all the way into the memory card slot until it clicks.

Not enough available space

- Delete some recordings on the memory card (📖 76, 81) or select [4 Mbps] for the conversion.



Recording was stopped due to insufficient write speed of the memory card

- The data transfer rate was too high for the memory card in use and the recording was stopped. Replace the memory card with one rated SD Speed Class 10.
- After repeatedly recording, deleting and editing scenes (fragmented memory), it will take longer to write data on the memory card and recording may stop. Save your recordings (📖 131) and initialize the memory card using the [Complete Initialization] option (📖 42).

Scene recorded using another device. Cannot play back the scene.

- Scenes that were not recorded with this camcorder cannot be played back.

Select the desired scene number

- A number of scenes have the same recording date but different file control information. This can occur for example when you record movies in the area of the international date line. Select a number to display the corresponding group of scenes.

Some scenes could not be deleted

- Movies that were protected/edited with other devices cannot be deleted with this camcorder.



Task in progress. Do not disconnect the power source.

- The camcorder is updating the memory card. Wait until the operation ends and do not remove the battery pack.

This photo cannot be displayed

- You may not be able to display photos taken with other devices or image files created or edited on a computer.

To record video on this memory card, it is recommended to use [Long Play] video quality.

- When using a memory card rated SD Speed Class 2, 4 or 6, you may not be able to record movies using a video quality option other than 4 Mbps.

Too many photos and MP4 movies. Disconnect the USB cable.

- Disconnect the USB cable. Try using a memory card reader or decrease the number of photos and movies on the memory card to fewer than 2,500 (Windows), or 1,000 (Mac OS).
- If a dialog box appeared on the computer screen, close it. Disconnect the USB cable, and restore the connection after a short while.

Unable to recover data

- Could not recover a corrupted file. Save your recordings (📖 131) and initialize the memory card using the [Complete Initialization] option (📖 42).



List of Messages for Wi-Fi Functions

Refer also to the instruction manual of your access point and other devices you will use.

Another user is already controlling the camcorder. Try again later.

- This message appears on the screen of the Wi-Fi device. Multiple Wi-Fi devices are trying to connect with the camcorder. Make sure only one Wi-Fi device is trying to connect and then touch Retry.

IP address conflict

- Change the camcorder's IP address to avoid any conflict with devices connected to the same network. Alternatively, change the IP address of the conflicting device.

Multiple access points detected. Try the operation again.

- There are multiple access points sending out a WPS signal at the same time. Try the operation again later or perform setup using the [WPS: PIN Code] or [Search for Access Points] option ( 163).



No access points found

- The access point set in the camcorder could not be found.
- Cordless phones, microwave ovens, refrigerators and other appliances may interfere with the wireless signal. Try using the camcorder in a location farther away from such appliances.
- Make sure that you use the access point's SSID for the camcorder's Wi-Fi settings (📖 168).
- If the access point is using MAC address filtering, enter the camcorder's MAC address in the access point's configuration screen.

Unable to access configuration files

- Turn off the camcorder. After a short while, turn it on again. If the problem persists contact a Canon Service Center.

Unable to complete WPS.

- Turn off the camcorder and access point (wireless router). After a short while, turn them on again and try again. If the problem persists, perform setup using the [Search for Access Points] option (📖 163).



Unable to complete WPS. Try the operation again.

- Some access points require pressing and holding the Wi-Fi Protected Setup (WPS) button. For details, refer to the instruction manual of your access point.
- Make sure to touch [OK] on the camcorder's screen within 2 minutes of activating the Wi-Fi Protected Setup signal on the access point, whether by pressing the button or by entering the PIN code.

Unable to connect

- Cordless phones, microwave ovens, refrigerators and other appliances may interfere with the wireless signal. Try using the camcorder in a location farther away from such appliances.



Unable to obtain an IP address

- If you are not using a DHCP server, connect using the [Manual Setup] option and enter the IP address using the [Manual] option (📖 171).
- Turn on the DHCP server. If it is already on, make sure it is functioning properly.
- Make sure the address range for the DHCP server is sufficient.
- Turn on the DNS server. If it is already on, make sure it is functioning properly.
- Make sure that the DNS server's IP address and the name for that address are correctly configured.
- Set the DNS server's IP address in the camcorder.
- If you are not using a DNS server, set the DNS address to [0.0.0.0].
- If you are using a wireless gateway router, make sure all of the devices in the network, including the camcorder, are configured with the correct gateway address.

Wi-Fi authentication unsuccessful

- Make sure the camcorder and access point are using the same authentication/encryption method and encryption key.
- If the access point is using MAC address filtering, enter the camcorder's MAC address in the access point's configuration screen.



Wi-Fi connection terminated

- Cordless phones, microwave ovens, refrigerators and other appliances may interfere with the wireless signal. Try using the camcorder in a location farther away from such appliances.
- The camcorder may not be able to connect to the access point if too many devices are accessing it. After a short while, establish the connection again.

Wi-Fi error. Incorrect authentication method.

- Make sure the camcorder and access point are correctly configured.
- Make sure the camcorder and access point are using the same authentication/encryption method and encryption key.
- If the access point is using MAC address filtering, enter the camcorder's MAC address in the access point's configuration screen.

Wi-Fi error. Incorrect encryption key.

- The encryption key (password) is case sensitive so make sure to enter it correctly.



Wi-Fi error. Incorrect encryption method.

- Make sure the camcorder and access point are using the same authentication/encryption method.
- If the access point is using MAC address filtering, enter the camcorder's MAC address in the access point's configuration screen.

Wireless communication is not working correctly

- Cordless phones, microwave ovens, refrigerators and other appliances may interfere with the wireless signal. Try using the camcorder in a location farther away from such appliances.
- Turn off the camcorder and access point (wireless router). After a short while, turn them on again and perform the Wi-Fi network setup again. If the problem persists contact a Canon Service Center.

List of Messages for Web Services

Check network settings

- The network settings in the camcorder are not correctly configured. Check the connection point, SSID and other network settings.



Trouble?

Connect to a computer and use supplied software to set up
This service may not be available in your region

- To use Web services, set in the camcorder the settings saved on CANON iMAGE GATEWAY. Install ImageBrowser EX and CameraWindow in your computer and configure the settings using CANON iMAGE GATEWAY.

Connect to a computer and use the supplied software to set again

- An error occurred when connecting to the CANON iMAGE GATEWAY server. Check the settings saved on CANON iMAGE GATEWAY and set them again in the camcorder.

Insufficient space on server

- You have exceeded the amount of data you can save on the CANON iMAGE GATEWAY server. Delete some data to free some space.

Movie must be less than X min.

- You attempted to send a movie whose length exceeds the maximum length allowed by the Web service (the maximum length differs according to the Web service). Shorten the movie and try sending it again.

Server busy Try again later

- The CANON iMAGE GATEWAY server is busy due to a high number of users trying to connect to the server. End the Wi-Fi connection and try again later.



This image cannot be sent

- You attempted to send a type of recording or a file with a size that is not supported by the selected Web service. Check the recording before sending.

Try again

- An error occurred when connecting to the CANON iMAGE GATEWAY server or the server is temporarily down. End the Wi-Fi connection and try again.



Handling Precautions

Camcorder

Be sure to observe the following precautions to ensure maximum performance.

- **Save your recordings periodically.** Make sure to transfer your recordings to an external device, such as a computer (📖 131), and save them on a regular basis. This will protect your important recordings in case of damage and create more free space on the memory card. Canon shall not be liable for any data loss.
- Do not carry the camcorder by the LCD panel. Be careful when closing the LCD panel.
- **Handle the touch screen with care.** Do not apply excessive force and do not use ballpoint pens or other hard-tipped tools to operate the touch screen. This may damage the touch screen's surface.
- Do not allow contact with metallic objects. If metallic objects come in contact with the touch screen, this may inadvertently cause incorrect operation of the camcorder.
- Do not hold the camcorder in the same posture for long periods of times as this may cause low-temperature contact burns. Even if the camcorder does not feel too hot, prolonged contact with the same body part may cause skin redness or



Do's and Don'ts

blistering. The use of a tripod is recommended for people with circulation problems or very sensitive skin, or when using the camcorder in very hot places.

- Do not leave the camcorder in places subject to high temperatures (like the inside of a car parked under direct sunlight), or high humidity.
- Do not use the camcorder near strong electromagnetic fields such as above TVs or near plasma TVs.
- Do not use the camcorder's Wi-Fi functions inside hospitals, medical clinics or onboard aircraft. In addition, do not use them near medical equipment or sensitive electronic devices as it may affect their performance. In the case of pacemakers, keep the camcorder at least 22 cm (8.7 in.) away from the device.
- The camcorder's Wi-Fi functions may be subject to interference from devices such as cordless phones and microwave ovens. Keeping as much distance as possible from these devices or using the camcorder's Wi-Fi functions at a different time of day may reduce such interference.
- Do not point the lens at strong light sources. Do not leave the camcorder pointed at a bright subject.
- Do not use or store the camcorder in dusty or sandy places. The camcorder is not waterproof – avoid also water, mud or salt. If any of the above should get into the camcorder it may damage the camcorder and/or the lens.



Do's and Don'ts

- Be careful of heat generated by lighting equipment.
- Do not disassemble the camcorder. If the camcorder does not function properly, consult qualified service personnel.
- Handle the camcorder with care. Do not subject the camcorder to shocks or vibration as this may cause damage.
- When mounting the camcorder on a tripod, make sure that the tripod's fastening screw is shorter than 5.5 mm (0.2 in.). Using other tripods may damage the camcorder.

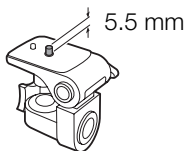

- **When recording movies, try to get a calm, stable picture.** Excessive camcorder movement while shooting can result in jittery scenes. In extreme cases, the playback of such scenes may result in visually induced motion sickness. If you experience such a reaction, stop the playback immediately and take a rest break as necessary.

■ Long-Term Storage

If you do not intend to use the camcorder for a long time, store it in a place free of dust, in low humidity, and at temperatures not higher than 30 °C (86 °F).



Battery Pack

DANGER!

Treat the battery pack with care.

- Keep it away from fire (or it might explode).
 - Do not expose the battery pack to temperature higher than 60 °C (140 °F). Do not leave it near a heater or inside a car in hot weather.
 - Do not try to disassemble or modify it.
 - Do not drop it or subject it to shocks.
 - Do not get it wet.
- Dirty terminals may cause a poor contact between the battery pack and the camcorder or battery charger. Wipe the terminals with a soft cloth.

■ Long-Term Storage

- Store battery packs in a dry place at temperatures no higher than 30 °C (86 °F).
- To extend the battery life of the battery pack, discharge it completely before storing it.
- Charge and discharge all your battery packs fully at least once a year.



Memory Card

- We recommend backing up the recordings on the memory card onto your computer. Data may be corrupted or lost due to memory card defects or exposure to static electricity. Canon shall not be liable for lost or corrupted data.
- Do not touch or expose the terminals to dust or dirt.
- Do not use memory cards in places subject to strong magnetic fields.
- Do not leave memory cards in places subject to high humidity and high temperature.
- Do not disassemble, bend, drop, or subject memory cards to shocks and do not expose them to water.
- Check the direction before inserting the memory card. Forcing a memory card into the slot if it is not correctly oriented may damage the memory card or the camcorder.
- Do not attach any labels or stickers on the memory card.
- When you delete movies or initialize the memory card, only the file allocation table is altered and stored data is not physically erased. When you dispose of the memory card or give either to another person, initialize the memory card using the [Complete Initialization] option (📖 42). Fill it up with unimportant recordings, and then initialize it again using the same option. This makes recovering the original recordings very difficult.



Built-in Rechargeable Lithium Battery

The camcorder has a built-in rechargeable lithium battery to keep the date/time and other settings. The built-in lithium battery is recharged while you use the camcorder; however, it will discharge completely if you do not use the camcorder for about 3 months.

To recharge the built-in lithium battery: Insert a fully charged battery pack into the camcorder or power it using the optional CA-110 Compact Power Adapter. Then, leave the camcorder 24 hours without turning it on.



Maintenance/Others

Cleaning

Camcorder Body

- Use a soft, dry cloth to clean the camcorder body. Never use chemically treated cloths or volatile solvents such as paint thinner.

Lens

- Remove any dust or dirt particles using a non-aerosol type blower brush.
- Use a clean, soft lens-cleaning cloth to gently wipe the lens. Never use tissue paper.

LCD Touch Screen

- Clean the LCD touch screen using a clean, soft lens-cleaning cloth.
- Condensation may form on the surface of the screen when the temperature changes suddenly. Wipe it with a soft dry cloth.



Condensation

Moving the camcorder rapidly between hot and cold temperatures may cause condensation (water droplets) to form on its internal surfaces. Stop using the camcorder if condensation is detected. Continued use may damage the camcorder.

Condensation may form in the following cases:

- When the camcorder is moved quickly from cold to warm places
- When the camcorder is left in a humid room
- When a cold room is heated rapidly

To avoid condensation

- Do not expose the camcorder to sudden or extreme changes in temperature.
- Remove the memory card and battery pack. Then, place the camcorder in an airtight plastic bag and let it adjust gradually to temperature changes before removing it from the bag.

When condensation is detected

The precise time required for water droplets to evaporate will vary depending on the location and weather conditions. As a general rule, wait for 2 hours before resuming use of the camcorder.



Using the Camcorder Abroad

Power Sources

You can use the supplied battery charger to charge battery packs in any country with power supply between 100 and 240 V AC, 50/60 Hz. Consult a Canon Service Center for information on plug adapters for overseas use.

Playback on a TV Screen

You can only play back your recordings on TVs compatible with the NTSC system or 60-Hz digital TV broadcasts. These are used in the following regions/countries:

Americas: All of North America and Central America; most Caribbean islands (except in French territories like Guadeloupe and Martinique); most of South America (except in Argentina, Brazil and Uruguay). **Asia:** Only in Japan, the Philippines, South Korea, Taiwan and Myanmar. **Oceania:** US territories (Guam, American Samoa, etc.) and some Pacific islands like Micronesia, Samoa and Tonga.



Optional Accessories

The following optional accessories are compatible with this camcorder but their availability may differ from area to area. Select accessories are described in more detail in the following pages.

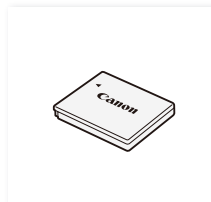

NB-4L Battery Pack



CB-2LV Battery Charger*

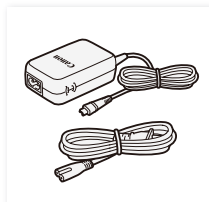

CA-110 Compact Power Adapter

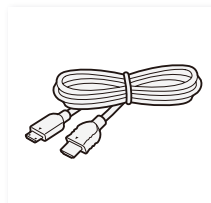

HTC-100 High Speed HDMI Cable

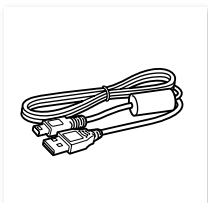

IFC-400PCU USB Cable

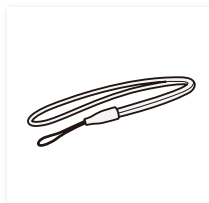

WS-DC11 Wrist Strap

* CB-2LVE (incl. power cord) in Asia.





SP-V1

Splashproof Case

Call or visit your local retailer/dealer for genuine Canon video accessories. You can also obtain genuine accessories for your Canon camcorder by calling: 1-800-828-4040, Canon U.S.A. Information Center.

Use of genuine Canon accessories is recommended.

This product is designed to achieve excellent performance when used with genuine Canon accessories. Canon shall not be liable for any damage to this product and/or accidents such as fire, etc., caused by the malfunction of non-genuine Canon accessories (e.g., a leakage and/or explosion of a battery pack). Please note that this warranty does not apply to repairs arising out of the malfunction of non-genuine Canon accessories, although you may request such repairs on a chargeable basis.



Battery Packs

When you need extra battery packs, use only the NB-4L.

CB-2LV or CB-2LVE Battery Charger

Use the battery charger to charge the battery packs. Fully charging a battery pack will take approximately 1 hour 30 minutes. (The actual charging time will vary depending on charging conditions and the initial charge of the battery pack.)

Approximate Usage Times

Recording and playback times given in the following table are approximate and vary according to video quality and charging, recording or playback conditions. The effective usage time of the battery pack may decrease when recording in cold surroundings, when using the brighter screen settings, etc.

Video quality	Recording (maximum)	Recording (typical)*	Playback
24 Mbps	65 min.	45 min.	110 min.
17 Mbps	65 min.	45 min.	110 min.
4 Mbps	70 min.	50 min.	115 min.

* Approximate times for recording with repeated operations such as start/stop, and power on/off.



This mark identifies genuine Canon video accessories. When you use Canon video equipment, we recommend Canon-brand accessories or products bearing the same mark.



Specifications

VIXIA mini

◆ – Values given are approximate figures.

System

• Recording System

Movies:

Video: MPEG-4 AVC/H.264

Audio: MPEG-2 AAC-LC (2ch)

Photos:

DCF (Design rule for Camera File system), compatible with Exif* Ver. 2.3

Image compression: JPEG

* This camcorder supports Exif 2.3 (also called “Exif Print”). Exif Print is a standard for enhancing the communication between camcorders and printers. By connecting to an Exif Print-compliant printer, the camcorder’s image data at the time of shooting is used and optimized, yielding extremely high quality prints.

• Video Signal Configuration: MP4

• Recording Media

microSD, microSDHC (SD High Capacity) or microSDXC (SD eXtended Capacity) memory card (not included)



- **Maximum Recording Time** ♦

Commercially available 16 GB memory card

24 Mbps: 1 hr. 25 min.

17 Mbps: 2 hr. 5 min.

4 Mbps: 8 hr. 40 min.

Commercially available 32 GB memory card

24 Mbps: 2 hr. 55 min.

17 Mbps: 4 hr. 10 min.

4 Mbps: 17 hr. 20 min.

- **Image Sensor**

1/2.3-in. CMOS, 12,800,000 pixels ♦

Effective pixels (ultra wide) ♦:

Movies: 8,990,000 pixels

Photos: 12,000,000 pixels

Effective pixels (close-up) ♦:

Movies: 2,070,000 pixels

Photos: 2,760,000 pixels

- **LCD Touch Screen**

2.7 in., TFT color, 230,000 dots ♦, capacitive touch screen operation

- **Microphone**

Stereo electret condenser microphone



- **Lens**

$f=2.7$ mm, F/2.8

35mm-equivalent focal length (ultra wide) ♦:

Movies: 16.8 mm Photos: 15.4 mm

35mm-equivalent focal length (close-up) ♦:

Movies: 35.0 mm Photos: 32.1 mm

- **Lens Configuration**

6 elements in 5 groups (1 double-sided aspheric element)

- **Focusing Distance**

Deep focus, 0.4 m (1.3 ft.) to infinity

- **White Balance**

Auto white balance, Custom white balance or Preset white balance settings: Daylight, Tungsten

- **Minimum Illumination**

10 lx ([Programmed AE] shooting mode, Shutter speed at 1/30)

- **Recommended Illumination:** More than 100 lx

- **Size of Video Recordings**

24 Mbps, 17 Mbps: 1920 x 1080 pixels

4 Mbps: 1280 x 720 pixels

3 Mbps: 640x360 (only during [x1/4] slow motion)



General Information

• Size of Photos

L 4000x3000 pixels, **M** 1920x1440 pixels, **S** 640x480 pixels
Photos captured from movies: 1920x1080 pixels

Terminals

- **USB Terminal:** mini-B, Hi-Speed USB
- **HDMI Terminal:** HDMI Mini Connector; output only

Wi-Fi

• Standard

Complies with the IEEE 802.11b/g/n protocol; Wi-Fi Protected Setup (connection methods: WPS button, PIN code)

- **Frequency:** 2.4 GHz
- **Supported channels:** 1 - 11
- **Encryption methods:** WEP-64/WEP-128, TKIP/AES

Power/Others

• Power supply (rated)

3.7 V DC (battery pack), 5.3 V DC (compact power adapter)

• Power consumption (17 Mbps video quality, normal brightness)♦

2.4 W

• Operating temperature♦: 0 – 40 °C (32 – 104 °F)



General Information

- **Dimensions** ♦ [W x H x D] (excluding the wrist strap)
76 x 22 x 96 mm (3.0 x 0.9 x 3.8 in.)
- **Weight** ♦ (camcorder body only)
160 g (5.6 oz.)

NB-4L Battery Pack

- **Battery type**
Rechargeable lithium ion battery
- **Rated voltage:** 3.7 V DC
- **Operating temperature** ♦: 0 – 40 °C (32 – 104 °F)
- **Battery capacity:** 760 mAh (typical)
- **Dimensions** ♦: 35.4 x 40.3 x 5.9 mm (1.4 x 1.6 x 0.23 in.)
- **Weight** ♦: 17 g (0.60 oz)

CB-2LV Battery Charger

- **Rated input**
100 – 240 V AC, 50/60 Hz, 0.1 A (100 V) – 0.06 A (240 V)
- **Rated output:** 4.2 V DC, 0.65 A
- **Charging time (NB-4L Battery Pack)** ♦: 1 hr. 30 min.
- **CHARGE indicator:** Orange - charging; Green - fully charged



General Information

- **Operating temperature**♦: 0 – 40 °C (32 – 104 °F)
- **Dimensions**♦: 53.0 x 86.0 x 19.5 mm (2.1 x 3.4 x 0.77 in.)
- **Weight**♦: 60 g (2.1 oz.)

Weight and dimensions are approximate. Errors and omissions excepted.

The information in this manual is verified as of June 2013. Specifications and outer appearance are subject to change without previous notice.





Index

- A**
- Abroad, using the camcorder.....234
 - AUTO mode54
 - Auto rotate183
 - Automatic backlight correction.....182
- B**
- Battery pack
 - Charging29
 - Remaining charge indicator198
 - Beach (shooting mode).....90
 - Built-in backup battery....231
- C**
- CameraAccess.....145
- CANON IMAGE GATEWAY154
- Capturing photos/video
 - snapshot scenes from a movie120
 - Cinema-look filters128
 - Close-up.....57
 - Condensation233
 - Connections to external devices125
 - Converting/Resizing movies.....128
- D**
- Date and time38
 - Decoration103
 - Deleting
 - Movies.....76

Photos.....81

E

Edit panel.....180

Error messages210

Exposure

compensation114

F

Face detection117

Facebook.....137, 151

Fast motion98

Field of view.....57

File numbering189

Flicker reduction182

Folder name189

Food and Fashion

(shooting mode).....90

Frame rate.....182

H

HDMI terminal124, 125

Home menu46, 178

I

Image rotation/flipping.... 108

Initializing a

memory card42

Interval recording.....94

L

LCD screen dimmer185

LCD touch screen44

M

Macro (shooting mode).... 90

Magnified playback.....74

Maintenance.....232

Markers185

Memory card34, 230

Mirror image playback.....69

Mirror image recording ... 108

Movie Uploader.....151

N

Night scene (shooting

mode).....90

Notification sounds189

- O**
- Onscreen icons 192
 - Orientation detection 108
 - Other Settings
 - menus 49, 180
- P**
- P (Programmed AE shooting mode)..... 90
 - Photo review time 182
 - Photo size 89
 - Playback
 - Movies..... 65
 - Photos..... 72
 - Power saving 60
- R**
- Recording
 - Movies..... 54
 - Photos..... 61
 - Remote Browse 148
 - Remote Control+
 - Streaming..... 145
 - Repeat playback 69
- Resetting all camcorder settings..... 191
- S**
- Saving recordings..... 131
 - Self timer 102
 - Serial number 24
 - Shooting mode 90
 - Shooting mode button 90
 - Slideshow 84
 - Slow motion 98
 - Smart AUTO..... 58
 - Snow (shooting mode) 90
 - Special recording
 - modes..... 94
 - Sports (shooting mode) 90
- T**
- Time zone/DST 41
 - Touch AE..... 116
 - Touch screen
 - operations..... 44
 - Trimming scenes..... 79
 - Tripod 228
 - Troubleshooting 199

Turning off notification
sounds 189

U

Ultra wide angle.....57

Uploading
movies.....137, 151, 154

USB terminal 124, 126

V

Video quality87

Video
snapshot..... 100, 120

Volume..... 67

W

White balance..... 112

Wi-Fi functions 138

Y

YouTube..... 137, 154

USA

CANON CONSUMER DIGITAL VIDEO EQUIPMENT LIMITED WARRANTY FOR THE UNITED STATES

The limited warranty set forth below is given by Canon U.S.A., Inc. ("Canon USA") with respect to Canon Consumer Digital Video Equipment (the "Equipment") purchased in the United States. This limited warranty is only effective upon presentation of your Bill of Sale or other proof of purchase.

The Equipment is warranted under normal, non-commercial, personal use, against defective materials or workmanship as follows:

Parts: Defective parts will be exchanged for new parts or comparable rebuilt parts for a period of ONE YEAR from the date of original purchase, except for a defective Video Head, which will be exchanged for a period of three months from the date of purchase.

Labor: For a period of ONE YEAR from the date of original purchase, labor will be provided free of charge by our factory service centers or designated service facilities located in the United States.

When returning Equipment under this warranty, you must pre-pay the shipping charges, and you must enclose the Bill of Sale or other proof of purchase with a complete explanation of the problem. During the ONE-YEAR warranty period, repairs will be made and the Equipment will be return-shipped to you free of charge. For repairs after the warranty period is over, you will be given an estimate of the cost of repair and an opportunity to approve or disapprove of the repair expense before it is incurred. If you approve, repairs will be made and the Equipment will be return-shipped to you. (shipping charges apply). If you disapprove, we will return-ship the equipment at no charge to you.

Non-Canon brand peripheral equipment and software which may be distributed with, or factory loaded on, the Equipment, are sold "AS IS" without warranty of any kind by Canon USA, including any implied warranty regarding merchantability or fitness for a particular purpose. The sole warranty with respect to such non-Canon brand items is given by the manufacturer or producer thereof. If the Equipment contains a hard disk drive, Canon USA recommends that data stored on that drive be duplicated or backed up to prevent its loss in the event of failure or other malfunction of such drive.

Canon USA shall have no responsibility under this limited warranty for use of the Equipment in conjunction with incompatible peripheral equipment and incompatible software.

In order to obtain warranty service, contact the authorized Canon retail dealer from whom you purchased the Equipment or call the CANON INFORMATION CENTER AT 1-800-OK-CANON). You will be directed to the nearest service facility for your Equipment.

This Limited Warranty covers all defects encountered in normal use of the Equipment and does not apply in the following cases:

- A) Loss or damage to the Equipment due to abuse, mishandling, accident, improper maintenance, or failure to follow operating instructions;
- B) If the Equipment is defective as a result of leaking batteries, sand, dirt or water damage;
- C) If defects or damages are caused by the use of unauthorized parts or by service other than by Canon USA's factory service centers or authorized service facilities;



D) If the Equipment is used for commercial or industrial use.

This Limited Warranty does not cover cabinet (exterior finish), video cassette tape, head cleanings, nor does it apply to Equipment purchased outside the United States. This warranty does not cover units sold to rental firms, military operations, hotels, schools, hospitals or for other commercial, industrial, or institutional applications. These uses are covered only by such specific warranty as Canon may issue with such sales.

This Limited Warranty does not apply to accessories or consumables for the Equipment, which are sold "AS IS", without warranty of any kind by Canon USA.

Please retain this warranty card and your Bill of Sale as a permanent record of your purchase. This card is most important in order to be sure you are contacted right away should there be a safety inspection, modification or product recall under applicable laws or regulations.

NO IMPLIED WARRANTY, INCLUDING MERCHANTABILITY AND FITNESS FOR A PARTICULAR PURPOSE APPLIES TO THIS EQUIPMENT AFTER THE APPLICABLE PERIOD OF EXPRESS WARRANTY OR GUARANTY, EXCEPT AS MENTIONED ABOVE, GIVEN BY ANY PERSON, FIRM OR CORPORATION WITH RESPECT TO THIS EQUIPMENT SHALL BIND THE UNDERSIGNED (SOME STATES DO NOT ALLOW LIMITATIONS ON HOW LONG AN IMPLIED WARRANTY LASTS, SO THE ABOVE LIMITATION OR EXCLUSION MAY NOT APPLY TO YOU). CANON USA SHALL NOT BE LIABLE FOR LOSS OF REVENUES OR PROFITS, EXPENSE FOR SUBSTITUTE EQUIPMENT OR SERVICE, STORAGE CHARGES, LOSS OR CORRUPTION OF DATA, INCLUDING WITHOUT LIMITATION, LOSS OR CORRUPTION OF DATA STORED ON THE EQUIPMENT'S HARD DRIVE, OR ANY OTHER SPECIAL, INCIDENTAL OR CONSEQUENTIAL DAMAGES CAUSED BY THE USE, MISUSE OR INABILITY TO USE THE EQUIPMENT, REGARDLESS OF THE LEGAL THEORY ON WHICH THE CLAIM IS BASED, AND EVEN IF CANON USA HAS BEEN ADVISED OF THE POSSIBILITY OF SUCH DAMAGES. NOR SHALL RECOVERY OF ANY KIND AGAINST CANON USA BE GREATER THAN THE PURCHASE PRICE OF THE EQUIPMENT SOLD BY CANON USA AND CAUSING THE ALLEGED DAMAGE. WITHOUT LIMITING THE FOREGOING, YOU ASSUME ALL RISK AND LIABILITY FOR LOSS, DAMAGE OR INJURY TO YOU AND YOUR PROPERTY AND TO OTHERS AND THEIR PROPERTY ARISING OUT OF USE, MISUSE OR INABILITY TO USE THE EQUIPMENT NOT CAUSED DIRECTLY BY THE NEGLIGENCE OF CANON USA. (SOME STATES DO NOT ALLOW THE EXCLUSION OR LIMITATION OF INCIDENTAL OR CONSEQUENTIAL DAMAGES, SO THE ABOVE LIMITATION MAY NOT APPLY TO YOU). THIS WARRANTY SHALL NOT EXTEND TO ANYONE OTHER THAN THE ORIGINAL PURCHASER OF THIS EQUIPMENT OR THE PERSON FOR WHOM IT WAS PURCHASED AS A GIFT.

This warranty gives you specific legal rights, and you may also have other rights which vary from state to state.

CANON U.S.A., INC.



CANADA

CANON CONSUMER DIGITAL VIDEO EQUIPMENT LIMITED WARRANTY

The limited warranty set forth below is given by Canon Canada Inc. ("Canon Canada") with respect to Canon Consumer Digital Video Equipment (the "Equipment") purchased in Canada. This limited warranty is only effective upon presentation of a bill of sale or other proof of purchase for this Equipment to a Canon Service Facility when repairs are required.

The Equipment is warranted under normal, non-commercial, personal use, against defective materials or workmanship as follows:

Parts: Defective parts will be exchanged for new parts or, at Canon Canada's option, comparable rebuilt parts for a period of one year from the date of original purchase, except Video Heads which will be exchanged for a period of 3 months from the date of purchase.

Labour: For a period of one year from the date of original purchase, labour will be provided free of charge by our Canon Service Facilities in Canada.

This limited warranty covers all defects except where:

(a) The loss or damage to the product results from:

- i) accident, natural disaster, mishandling, abuse, neglect, unauthorized product modification or failure to follow instructions contained in the instruction manual;
- ii) the use of accessories, attachments, products, supplies, parts or devices with the Equipment that do not conform to Canon specifications or that cause abnormally frequent service problems;
- iii) repairs or services performed by any party other than a Canon Service Facility;
- iv) defective batteries or any exposure to water, sand or dirt;
- v) shipping (claim must be presented to the shipper);

(b) Any serial number on the video equipment is altered or removed.

(c) The Equipment is used for commercial, professional or industrial purposes.

This limited warranty does not cover the cabinet (exterior finish) of the Equipment, media, nor does it apply to Equipment purchased outside Canada.

If the Equipment contains a hard disk drive, Canon Canada recommends that data stored on that drive be duplicated or backed up to prevent its loss in the event of a failure or other malfunction of such drive.

TO OBTAIN WARRANTY SERVICE

Ship your Equipment in its original carton, box or equivalent, properly packed, fully insured with shipping charges prepaid, together with a copy of your bill of sale or other proof of purchase and a description of the problem to any of the Canon Service Facilities in Canada.

LIMITATIONS

Except as otherwise required by applicable legislation, this warranty is in lieu of all other warranties, conditions, guarantees or representations, express or implied, statutory or otherwise, relative to the Equipment, including implied warranties or conditions of merchantability or fitness for a particular purpose.



Canon Canada assumes no liability for special, consequential or incidental damages, loss or corruption of data including, without limitation, data stored on the hard disk drive of the Equipment or loss that may arise, whether on account of negligence or otherwise, from the use, misuse or inability to use the Equipment (including loss of profit, revenue, media or enjoyment) or from failure to conform to any express or implied warranties, conditions, guarantees or representations. Any recovery under this limited warranty shall not exceed the purchase price of the equipment. Canon Canada does not assume or authorize any other person to assume for Canon Canada any other liability with respect to this equipment.

This warranty does not extend to any person other than the original purchaser of the Equipment or the person for whom it was purchased as a gift and states your exclusive remedy.

NOTICE TO CONSUMER

If you plan to take important videos or if the product has not been used for some time, please check all functions with the instruction book before using it.



USA

CANON U.S.A., INC. NEW JERSEY OFFICE

100 Jamesburg Road, Jamesburg, NJ 08831 USA

CANON U.S.A., INC. CHICAGO OFFICE

100 Park Blvd., Itasca, IL 60143 USA

CANON U.S.A., INC. LOS ANGELES OFFICE

15955 Alton Parkway, Irvine, CA 92618 USA

CANON U.S.A., INC. HONOLULU OFFICE

210 Ward Avenue, Suite 200, Honolulu, HI 96814 USA

- ❖ If you have any questions, call the Canon U.S.A. Information Center toll-free at 1-800-828-4040 (USA only).

CANADA

CANON CANADA INC.

6390 Dixie Road, Mississauga, ON L5T 1P7

- ❖ If you have any questions, call the Canon Canada Information Center toll free (in Canada only) at 1-800-OK-CANON (1-800-652-2666).
- ❖ Si vous avez des questions, veuillez téléphoner 1-800-OK-CANON (1-800-652-2666, sans frais au Canada seulement).

MÉXICO

CANON MEXICANA, S DE RL DE CV

Blvd. Manuel Ávila Camacho No. 138, Piso 17

Col. Lomas de Chapultepec, C.P. 11000 México, D.F., México

CANON U.S.A., INC. NEW JERSEY OFFICE

100 Jamesburg Road, Jamesburg, NJ 08831 USA

CENTRO Y SURAMÉRICA

CANON LATIN AMERICA, INC.

One Canon Park, Melville, NY 11747 USA

ASIA

CANON HONGKONG COMPANY LTD.

19/F, The Metropolis Tower, 10 Metropolis Drive, Hungghom, Kowloon, Hong Kong

Tel: +852 3191 2333, Fax: +852 2428 3963