

EPSON®

14" Super VGA Color Monitor

(Models A881381, A881389, and A881371)

User's Guide



(for models A881381 and A881389)

**FCC COMPLIANCE STATEMENT
FOR AMERICAN USERS**

This equipment has been tested and found to comply with the limits for a class B digital device, pursuant to Part 15 of the FCC Rules. These limits are designed to provide reasonable protection against harmful interference in a residential installation. This equipment generates, uses and can radiate radio frequency energy and, if not installed and used in accordance with the instructions, may cause harmful interference to radio communications. However, there is no guarantee that interference will not occur in a particular installation. If this equipment does cause harmful interference to radio or television reception, which can be determined by turning the equipment off and on, the user is encouraged to try to correct the interference by one or more of the following measures:

- Reorient or relocate the receiving antenna.
- Increase the separation between the equipment and receiver.
- Connect the equipment into an outlet on a circuit different from that to which the receiver is connected.
- Consult the dealer or an experienced radio/TV technician for help.

NOTICE

- (1) Any changes or modification not expressly approved by the party responsible for compliance could void the user's authority to operate the equipment.
- (2) Shielded interface cables and AC power cord must be used in order to comply with the emission limits.

FOR CANADIAN USERS

This digital apparatus does not exceed the Class B limits for radio noise emissions from digital apparatus as set out in the radio interference regulations of the Canadian Department of Communications,

Le présent appareil numérique n'émet pas de bruits radioélectriques dépassant les limites applicables aux appareils numériques de Classe B prescrites dans le règlement sur le brouillage radioélectrique édicté par le Ministère des Communications du Canada.

**IMPORTANT NOTICE
DISCLAIMER OF WARRANTY**

Epson America makes no representations or warranties, either express or implied, by or with respect to anything in this manual, and shall not be liable for any implied warranties of merchantability and fitness for a particular purpose or for any indirect, special, or consequential damages. Some states do not allow the exclusion of incidental or consequential damages, so this exclusion may not apply to you.

COPYRIGHT NOTICE

AU rights reserved. No part of this publication may be reproduced, stored in a retrieval system, or transmitted, in any form or by any means, electronic, mechanical, photocopying, recording, or otherwise, without the prior written permission of Epson America, Inc. No patent liability is assumed with respect to the use of information contained herein. Nor is any liability assumed for damages resulting from the use of the information contained herein. Further, this publication and features described herein are subject to change without notice.

TRADEMARKS

EPSON is a registered trademark of Seiko Epson Corporation.
EPSON Connection and EPSON Direct are service marks of Epson America, Inc.

General notice: Other product names used herein are for identification purposes only and may be trademarks of their respective companies.

The Energy Star emblem does not represent EPA endorsement of any product or service.

Important Safety Instructions

Although this monitor is designed to assure your safety, improper use can cause electric shock or fire hazard. In order not to defeat the safeguards incorporated in the monitor, observe the following safety instructions:

1. Read all of these instructions and save them for later reference.
2. Follow all warnings and instructions in this manual and marked on the monitor.
3. The monitor contains shock hazard potential. Do not attempt to open or remove any covers, and do not attempt to service the monitor yourself. Refer all servicing to authorized service personnel.
4. Never push objects of any kind into the monitor through cabinet slots.
5. Do not expose the monitor to liquids, such as rain or spills.
6. Do not place the monitor on an unstable cart, stand, or table, and be careful not to drop it.
7. Do not place the monitor near a heating appliance or in direct sunlight. Intense heat can damage the monitor's circuitry.
8. Slots and openings on the top, sides, and back of the cabinet are provided for ventilation; do not block or cover these openings. Do not place the monitor in a built-in insulator, such as a bookcase, unless proper ventilation is provided.
9. Power supply voltages outside the monitor's specified line voltage range may harm the monitor. The monitor should be operated from the type of power source indicated on the rear panel marking label.
10. Make sure the combined amperage rating for all products plugged into the wall outlet used for the monitor does not exceed the amperage rating of the wall outlet.
11. Use only the power cord supplied with the monitor. If you must use another power cord, make sure it meets the applicable standards (UL/CSA).
12. Do not overload the computer inlet and extension cords as this can result in fire or electric shock.
13. Be careful not to damage the power cord or plug.

14. Do not allow anything to rest on the power cord. Do not place a cord where it may be stepped on.
15. Do not replace the video interface cable with a non-shielded cable.
16. Unplug the monitor from the computer and the wall outlet before cleaning. Use a damp cloth for cleaning.
17. Excessive brightness for long periods may permanently imprint an image on the screen.
18. To avoid picture distortion or color disturbance, do not put devices that generate magnetism (such as telephones, televisions, speakers, or magnetic screwdrivers) near the monitor.
19. When the monitor will not be used for a long period of time, turn it off by pressing the power button. (Always wait at least five seconds before you turn it back on.)
20. Unplug the monitor from the computer and the wall outlet and refer servicing to authorized service personnel under the following conditions:
 - A. If the power cord or plug is damaged.
 - B. If the monitor has come into contact with any liquids, such as rain or spills.
 - C. If the monitor does not operate normally when the operating instructions are followed. Adjust only those controls that are covered by the operating instructions; improper adjustment of other controls may result in damage and will often require extensive work by a qualified technician to restore the product to normal operation.
 - D. If the monitor has been dropped or the cabinet or glass faceplate has been damaged.
 - E. If the monitor exhibits a distinct change in performance.

Importantes mesures de sécurité

Bien que le moniteur soit conçu pour assurer votre sécurité, un usage incorrect peut provoquer une décharge électrique ou poser un risque d'incendie. Pour ne pas aller à l'encontre des mesures de protection incorporées dans le moniteur, veuillez bien observer ces instructions:

1. Lire attentivement les instructions qui suivent Les conserver en lieu sûr.
2. Observer les avertissements marqués sur le moniteur et suivre rigoureusement les instructions contenues dans le manuel.
3. Le moniteur pose des risques de décharge électrique. Ne pas tenter de soulever ou d'enlever les couvercles; ne pas essayer de réparer le moniteur soi-même; s'adresser au personnel de service autorisé par le fabricant.
4. Ne jamais rien introduire dans les ouvertures du coffre.
5. Protéger le moniteur de tout contact avec l'eau, la pluie, les boissons renversées, etc.
6. Ne pas laisser tomber l'appareil. Éviter de le placer sur un meuble instable.
7. Ne pas placer le moniteur à proximité d'un appareil de chauffage, ni en plein soleil. La chaleur intense peut endommager les circuits.
8. Il est important de ne pas bloquer les ouvertures situées sur le dessus et derrière l'appareil: ce sont des prises d'air qui en assurent l'aération. Ne pas placer le moniteur à l'intérieur d'un placard, ou sur les rayons d'une bibliothèque fermée, à moins d'y avoir une bonne circulation d'air.
9. Un voltage inférieur ou supérieur à celui qui est spécifiquement désigné pour le moniteur pourrait l'endommager. Utiliser seulement la source d'électricité indiquée sur l'étiquette à l'arrière de l'appareil.
10. L'ampérage total de toutes les pièces branchées sur le même socle ne doit pas dépasser la capacité en ampères du socle.
11. Utiliser seulement le cordon électrique dont le moniteur est mun. S'il est nécessaire de se servir d'un autre cordon, s'assurer que les standards de fabrication sont conformes aux règlements en vigueur (UL/CSA).
12. Ne pas surcharger les prises de courant ni les cordons prolongateurs, car cela pourrait mettre le feu ou causer une décharge électrique.

13. Faire attention à ne pas abîmer le cordon électrique ni la prise de courant.
14. Ne rien mettre ni laisser sur les cordons électriques. Pour éviter de leur marcher dessus, ne pas les installer dans un endroit de passage.
15. Ne pas remplacer un cordon d'interface par un cordon non protégé.
16. Débrancher le moniteur du socle et de l'ordinateur avant de le nettoyer. Utiliser seulement un chiffon humide.
17. Si la luminosité de l'écran reste à sa plus haute intensité pendant de longues périodes, l'image pourrait y rester imprimée de façon permanente.
18. Pour éviter les déformations de l'image ou les perturbations de couleur, ne pas placer de sources de magnétisme telles que téléphones, postes de télévision, ou haut-parleurs à proximité du moniteur.
19. Lorsqu'on ne devra pas utiliser le moniteur pendant de longues périodes, l'éteindre en pressant l'interrupteur. Toujours attendre au moins cinq secondes avant de le remettre en marche.
20. Débrancher le moniteur et s'adresser au personnel de service autorisé dans les conditions suivantes:
 - A. Si le cordon est effiloché ou la prise est endommagée
 - B. Si le moniteur est entré en contact avec des liquides.
 - C. Si le moniteur ne répond pas normalement aux commandes passées en suivant les instructions. Ajuster uniquement les contrôles décrits dans les instructions; il est possible de gravement endommager l'appareil en touchant les autres, ce qui pourrait nécessiter l'intervention d'un technicien qualifié pour le remettre en état de marche.
 - D. Si le moniteur est tombé ou si l'écran ou le coffre ont été endommagés.
 - E. Si la performance du moniteur est nettement différente de l'ordinaire.

Contents

Introduction	1
Energy Star Compliant	1
WheretToGetHelp	2
CompuServe On-line Support	3
Unpacking the Monitor	4
Setting Up the Monitor	4
Attaching the Tilt and Swivel Base	5
Selecting a Location for the Monitor	7
Connecting the Monitor to Your Computer	7
Turning On the Monitor	9
Adjusting the Monitor Controls	9
Cleaning the Monitor	11
Troubleshooting	11
Specifications	23

Introduction

Your EPSON® Super VGA Color Monitor is compatible with all IBM® 8514A, VGA, and Super VGA modes from 31 to 35 KHz. It offers the following features:

- ❑ 14-inch, analog color CRT display
- ❑ High-resolution display of up to 1024 x 768 pixels, interlaced
- ❑ Six user-adjustable controls: brightness, contrast, horizontal centering, horizontal size, vertical centering, and vertical size
- ❑ Universal power supply with automatic line voltage selection between 100 and 240 volts
- ❑ Tilt and swivel base.

This manual provides instructions on how to set up and use the monitor. It also provides troubleshooting information and specifications.

Energy Star Compliant



The A881381 and A881389 monitors comply with the U.S. Environmental Protection Agency's Energy Star program, which promotes the manufacture of energy-efficient printers, computers, and monitors. If your computer is Energy Star compliant, the EPSON Super VGA Color Monitor automatically enters a low-power, standby mode when the computer stops sending certain signals to the monitor. The power indicator at the front right of the monitor turns amber when the monitor is in this low-power state.

The EPA estimates that if all desktop computers, monitors, printers, and other peripheral devices met Energy Star standards, energy cost savings would exceed \$1 billion annually and carbon monoxide emissions would be reduced by 20 million tons.

The Energy Star emblem does not represent EPA endorsement of any product or service.

Where to Get Help

If you purchased your monitor outside the United States, contact an EPSON representative at the nearest marketing location for support and service. International marketing locations are listed at the back of this manual.

If you purchased your monitor in the United States, EPSON provides the following support services through the EPSON ConnectionSM:

- Technical assistance with the installation, configuration, and operation of EPSON products
- Assistance in locating your nearest Authorized EPSON Reseller or Service Center
- Sales of supplies, parts, documentation, and accessories for your EPSON products
- Customer Relations
- EPSON Fax Back technical information service-available directly by calling the toll number (310) 782-4214
- Product literature with technical specifications on current and new products
- User group locations.

You can reach the EPSON Connection at (800) 922-8911, or call (310) 782-0770 and ask for the EPSON Connection.

CompuServe® On-line Support

The fastest way to access helpful tips, specifications, and bulletins is through the Epson America Forum on CompuServe.

If you are not currently a member of CompuServe, you are eligible for a free introductory membership as an owner of an EPSON product. This membership entitles you to:

- An introductory \$15 credit on CompuServe
- Your own user ID and password
- A complimentary subscription to *CompuServe Magazine*, CompuServe's monthly publication.

To take advantage of this offer, call (800) 848-8199 in the United States and Canada and ask for representative #529. In other countries, call (614) 529-1611 or your local CompuServe access number.

If you are already a CompuServe member, simply type GO EPSON at the menu prompt to reach the Epson America Forum.

Unpacking the Monitor

When you unpack your monitor, make sure you have these items:

- EPSON 14" Super VGA Color Monitor
- AC power cord (to connect the monitor to a wall outlet)
- Video interface cable (to connect the monitor to your computer)
- Tilt and swivel base
- Warranty card
- Registration card.

If anything is missing or damaged, contact your EPSON representative immediately.

Be sure to keep the monitor's original box and packing materials in case you need to transport the monitor later.

Setting Up the Monitor

This section describes how to attach the tilt and swivel base, select a location for the monitor, and connect the monitor to your computer.

Attaching the Tilt and Swivel Base

Before you attach the tilt and swivel base, cover your work area with a blanket or foam pad to avoid scratching the monitor during assembly. Then follow these steps:

1. Carefully set the monitor face down on the padding so the bottom of the monitor is facing you.
2. Locate the four sets of hooks on the top portion of the base.

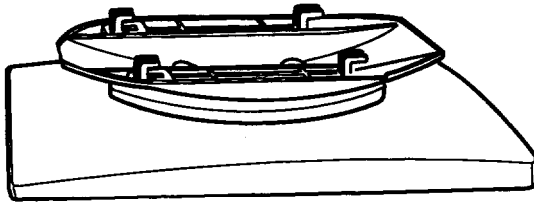

3. Hold the base so the hooks are turned down and position the base next to the bottom of the monitor.

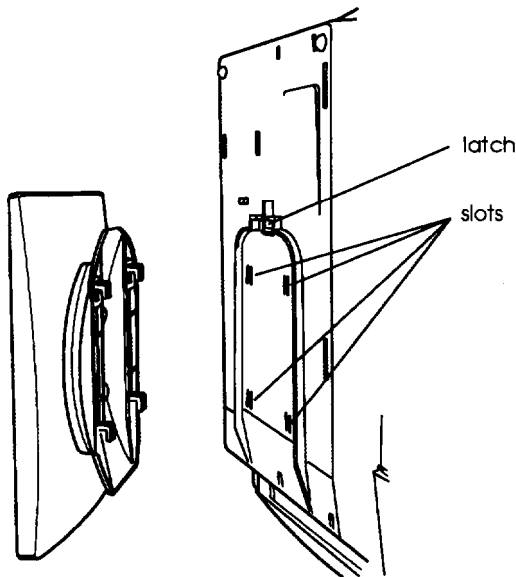

4. Insert the hooks into the slots on the monitor.
5. Slide the base toward the front of the monitor until the latch clicks into the locked position. Then turn the monitor over so it rests on the base.

Note

Always remove the tilt and swivel base before packing and transporting the monitor. To remove the base, disconnect the power cord from the electrical outlet and disconnect the cables from the back of the monitor. Carefully set the monitor face down on a padded surface. While pressing the latch on the bottom of the monitor, remove the base by lifting the hooks out of the slots.

Selecting a Location for the Monitor

Follow these guidelines when you select a location for the monitor:

- ❑ Read the safety instructions at the beginning of this manual.
- ❑ Use a large, sturdy desk that can support the weight of the computer, monitor, and any peripheral devices. The desk should also provide ample space to hold your equipment and work materials.
- ❑ For your comfort, it is best to place the monitor directly in front of you and sit about an arm's length away from it.
- ❑ To minimize glare and reduce eye fatigue, position the monitor so that sunlight, desk lamps, or overhead lights do not shine directly on the screen.
- ❑ For comfortable viewing, the top of the screen should be slightly below eye level when you are sitting in front of the monitor. Your line of sight to the screen should be about 10° to 20° below the horizontal.

Connecting the Monitor to Your Computer

before you connect the monitor to your computer, make sure your computer and video adapter are set up to use with the monitor. If necessary, install an appropriate video adapter card in your computer and set any DIP switches or jumpers on the card to match the monitor. You may also need to change jumper settings inside the computer. See your computer or video adapter card manual for instructions.

Follow these steps to connect the monitor to your computer:

1. Make sure the monitor, computer, and any peripheral devices are turned off.
2. Turn the monitor around so the back of the monitor is facing you.
3. Plug the video interface cable into the VGA connector shown below. Tighten the two screws on the cable connector.

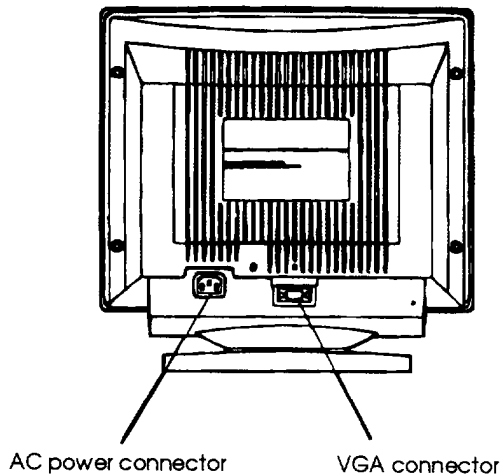

4. Plug the other end of the video cable into the video connector on the back of the computer. Then tighten the two screws on the cable connector.
5. Plug the power cord into the AC receptacle on the back of the monitor.
6. Plug the other end of the power cord into a properly grounded wall outlet.

The monitor contains a universal power supply, so you can connect it to any wall outlet supplying between 100 and 240 volts.

Turning On the Monitor



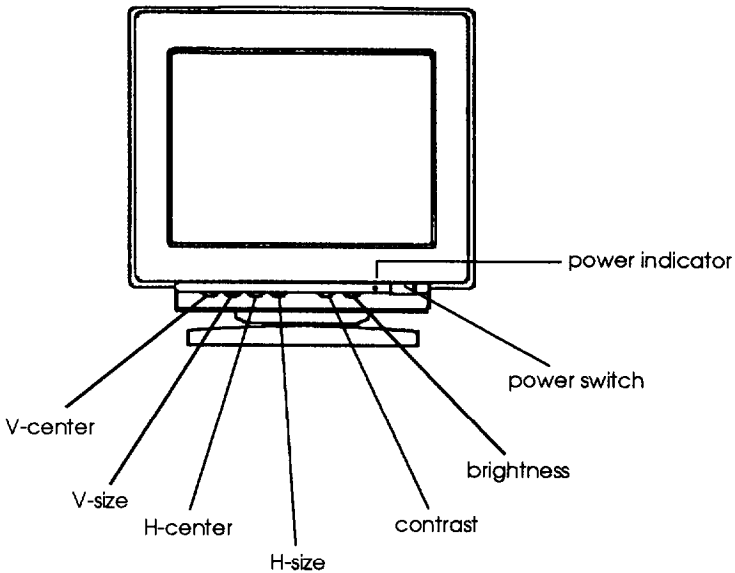



Turn on the monitor by pressing the power button located at the front right of the monitor. Then turn on the computer. After a few seconds, an image appears on the screen. To make the image on the screen clear and easy to read, use the brightness and contrast controls.



The power indicator is green when you first turn on the monitor and when the monitor is in the full-power state. When the monitor is in the low-power state, the power indicator is amber.

Adjusting the Monitor Controls

The controls on the front of the monitor allow you to adjust the display to suit your preferences. The following table summarizes the functions of the monitor's controls.

Control	Icon	Function
Vertical center		Centers the image vertically. Turn the control clockwise to move the image up; turn it counterclockwise to move the image down.
Vertical size		Adjusts the vertical size of the image. Turn the control clockwise to increase the height; turn it counterclockwise to decrease the height.
Horizontal center		Centers the image horizontally. Turn the control clockwise to move the image to the left; turn it counterclockwise to move the image to the right.
Horizontal size		Adjusts the width of the image. Turn the control clockwise to increase the width; turn it counterclockwise to decrease the width.
Contrast		Adjusts the contrast (the degree of difference between the lightest and darkest parts of the display). Turn the control clockwise to increase the contrast; turn it counterclockwise to decrease the contrast.
Brightness		Adjusts the brightness of the image. Turn the control clockwise to increase the brightness; turn it counterclockwise to decrease the brightness.
Power button		Turns the monitor on and off.

Cleaning the Monitor

To keep the monitor operating at its best, it is important to clean it regularly. Follow these steps:

1. Turn off the monitor and unplug the power cord from the wall outlet. Also disconnect the video interface cable from the computer.
2. Use a damp, lint-free cloth to wipe the monitor casing; do not use a wet cloth.
3. To clean the screen, spray a household glass cleaner on a cloth; then wipe the screen.

Caution

To avoid electric shock, do not spray cleaner directly on the monitor. Do not use solvents, abrasives, or aerosol cleaners to clean the monitor; they can discolor the casing or damage the surface of the screen.

Troubleshooting

This section gives solutions to monitor problems you might encounter. If these procedures do not solve the problem, see page 2 for information on where to get help.

The power indicator light does not light.

1. The monitor's power may not be on. Press the power button.
2. The power cord might be unplugged or not fully connected. Make sure the power cord is properly connected to both the monitor and the electrical outlet.

3. The electrical outlet might be dead. Test the outlet by plugging in a lamp or other device.

The power indicator is on, but there is no image on the screen.

1. Make sure the computer is turned on.
2. Make sure the video interface cable is properly connected to the monitor and the video interface on the computer. See “Connecting the Monitor to Your Computer” on page 7.
3. Adjust the contrast and brightness controls. See page 10.
4. The input signals may be outside the monitor’s horizontal and vertical frequency ranges (31-35 KHz horizontal and 56-87 Hz vertical). Make sure the input signals are within the specified ranges.
5. Make sure your computer’s DIP switches, jumpers, and setup program settings match the monitor’s settings. If you are using a video card, make sure any DIP switches or jumpers on the card are set properly. See your computer or video adapter card manual for instructions.
6. Make sure your application program settings are correctly set for the monitor.

The image is not centered or it locks in place on the screen.

Adjust the H-center and V-center controls on the front of the monitor as described on page 10.

The image is too big or too small for the screen.

Adjust the H-size and V-size controls on the front of the monitor as described on page 10.

The image is scrambled.

The input signals may be outside the monitor's horizontal and vertical frequency ranges (31-35 KHz horizontal and 56-87 Hz vertical). Make sure the input signals are within the specified ranges.

Specifications

Model Numbers A881381, A881389, and A881371

CRT

Size	14 inches (356 mm) diagonal
Resolution	1024 x 768
Display area	9.6 x 7 inches (245 x 180 mm)
Deflection angle	90°
Dot pitch	0.28 mm (A881381 and A881389) 0.39 mm (A881371)
Surface	Non-glare (A881381 and A881389)
Misconvergence	0.35/0.5 mm (A881381 and A881389) 0.6/0.7 mm (A881371)

Video and Synchronization Signals

Video	Analog
bandwidth	45 MHz
Signal cable	15-pin, D-sub connector

Physical Characteristics

Weight	22.9 lb (10.4 Kg)
Width	14.2 inches (361 mm)
Height	15.2 inches (386 mm)
Depth	13.8 inches (351 mm)

Epson America (USA)

Epson America, Inc.
20770 Madrona Avenue
Torrance, CA 90509-2842
Tel: (310) 782-0770
(800) 289-3776
Fax: (310) 782-5051

EPSON Connection
Tel: (800) 922-8911

EPSON DirectSM
P.O. Box 2858
20770 Madrona Avenue
Torrance, CA 90509-1111
Tel: (800) 374-7300 (Technical support and sales)
(310) 782-5478 (Sales)
Fax: (310) 782-4455 (Technical support and sales)

Epson America (International)

Epson Latin America
Miami, FL, USA
Tel: (305) 265-0092
Fax: (305) 265-0097

Epson Argentina, S.A.
Buenos Aires, Argentina
Tel: (541) 322-7487
Fax: (541) 322-4637

Epson Chile, S.A.
Santiago, Chile
Tel: (562) 232-8966
Fax: (562) 233-3197

Epson Costa Rica, S.A.
San Jose, Costa Rica
Tel: (506) 34-6666
Fax: (506) 25-5709

Epson Mexico, S.A. De C.V.
Mexico, D.F., Mexico
Tel: (525) 395-9897
Fax: (525) 395-9499

Epson Do Brasil
São Paulo, SP Brazil
Tel: (5511) 813-3044
Fax: (5511) 210-9290

Epson Venezuela, S.A.
Caracas, Venezuela
Tel: (582) 241-0433
Fax: (582) 241-6515

Epson Canada Limited
Willowdale, Ontario, Canada
Tel: (416) 498-9955
Fax: (416) 498-4574

Epson International Marketing Locations

Epson Deutschland GmbH
Zülpicher Straße 6,
4000 Düsseldorf 11
Germany
Phone: 211-56030
Telex: 41-8584786

Epson Iberica, S.A.
Avda. de Roma 18-26
08290 Cerdanyola del valles
08036 Barcelona, Spain
Phone: 3-582-15-00
Fax: 3-582-15-55
Telex: 50129

Epson Hong Kong Ltd.
25/F., Harbour Centre,
25 Harbour Road
Wanchai, Hong Kong
Phone: 831-4600
Fax: 572-5792
Telex: 65542 EPSCO I-IX

Epson Electronics Trading Ltd.
Taiwan Branch
10F, No. 287, Nanking E. Road,
Sec. 3, Taipei, Taiwan R.O.C.
Phone: 886-2-717-7360
Free phone: 886-080-211172
Fax: 886-2-712-9164
Telex: 785-24444

Epson (U.K.) Ltd.
Business Management Dept. (PC)
Campus 100, Maylands Avenue
Hemel Hempstead, Hertfordshire,
HP27EZ, UK
Phone: 0442 61144
Free phone: linkline 0800 289622
Fax: 0422 227227
Telex: 51-824767

Epson France S.A.
B.P. 320,68 Bis Rue Marjolin
92305 Levallois-Perret Cedex
France
Phone: 33-14737-3333
Telex: 42-610657

Epson Italia s.p.a.
V.le F.lli Casiraghi, 427
20099 Sesto S. Giovanni
Milano, Italy
Phone: 2-262331
Fax: 2-2440641 or 2-2440750
Telex: 315132

Epson Australia Pty. Ltd.
17 Rodborough Road
Frenchs Forest, N.S.W. 2086
Australia
Phone: 2-452-0666
Fax: 2-451-0251
Telex: 71-75052

Epson Singapore Pte. Ltd.
No. 1 Raffles Place #26-00,
Oub Centre, Singapore 0104
Phone: 533-0477
Telex: 87-39536

Distributors

South America

SISCO

São Paulo, SP Brazil
Tel: (5511) 574-8877
Fax: (5511) 572-1306

Exhibit Computer
Bogota, Colombia
Tel: (571) 218-2700
Fax: (571) 218-5370

UPEN Computer Systems
Bogota, Colombia
Tel: (571) 257-7800

Ace Computers & Electronics
Georgetown, Guyana
Tel: (592) 25-65-48
Fax: (592) 26-39-67

Alvimer S.R.L. Trading Inc.
Ciudad Del Este, Paraguay
Tel: (595) 61-60234
Fax: (595) 61-60566

Control De Procesos Informaticos
Lima, Peru
Tel: (5114) 328-384
Fax: (5114) 355-017

Interfase S.A.
Montevideo, Uruguay
Tel: (598) 249-4600
Fax: (598) 249-3040

Siser Ltda.
La Paz, Bolivia
Tel: (591-2) 3432-45
Fax: (591-2) 35-92-68

McSilver, S.A.
Bogota, Colombia
Tel: (571) 230-1014
Fax: (571) 230-9205

C.I.L.D.S.E.
Quito, Ecuador
Tel: (593) 2-54-3418
Fax: (593) 2-55-4780

A.J. Vierci & CIA
Asuncion, Paraguay
Tel: (595) 21-449-220
Fax: (595) 21-449-234

Infocenter
Asuncion, Paraguay
Tel: (595) 214-98762
Fax: (595) 214-49514

Peru Mercantil, S.A.
Lima, Peru
Tel: (5114) 62-2566
Fax: (5114) 61-8256

Caribbean

Caribbean Computer Systems, Ltd.
Bridgetown, Barbados
Tel: (809) 429-7050
Fax: (809) 427-6089

North Atlantic Data Systems
Hamilton, Bermuda
Tel: (809) 295-7111
Fax: (809) 292-3834

Columbus Limited
Grand Cayman, West Indies, B.W.I.
Tel: (809) 949-8039
Fax: (809) 949-7537

WTG/APTEC Systems Limited
Kingston, Jamaica
Tel: (809) 929-9250
Fax: (809) 929-8296

Computer Gallery
Hato Rey, Puerto Rico
Tel: (809) 753-0500
Fax: (809) 753-0552

IMCON Limited
Castries, St. Lucia, West Indies
Tel: (809) 452-6130
Fax: (809) 452-3883

Da Costas Limited
Bridgetown, Barbados
Tel: (809) 427-5854
Fax: (809) 436-9870

The Computer Center
Nassau, Bahamas
Tel: (809) 328-0304
Fax: (809) 328-0307

Compusupplies, Ltd.
Kingston, Jamaica
Tel: (809) 925-8382
Fax: (809) 925-8115

Boolchand Pessomal N.V.
Curacao, Netherlands Antilles
Tel: (599) 961-7545
Fax: (599) 961-7876

Micro Internacional, S.A.
Santo Domingo, Republica Dominicana
Tel: (809) 533-7096
Fax: (809) 535-3218

Complete Computer Systems
Port-of-Spain, Trinidad
Tel: (809) 625-1204
Fax: (809) 623-5426

Central America

Equipos Electronicos Valdez y Cia
San Salvador, El Salvador
Tel: (503) 23-73-43
Fax: (503) 24-53-82

Servicio Integral De Computacion, S.A.
Guatemala, Guatemala
Tel: (502-2) 31-11-70
Fax: (502-2) 32-52-22

Micro-Tee
Managua, Nicaragua
Tel: (505-2) 66-27-15
Fax: (505-2) 66-27-58

PS2000
Guatemala, Guatemala
Tel: (502-2) 32-57-44
Fax: (502-2) 31-24-49

CODASA
Tegucigalpa, Honduras
Tel: (504) 33-5685
Fax: (504) 58-0255

Sonitel, C.A.
Panama, Republica De Panama
Tel: (507) 63-98-00
Fax: (507) 63-98-15