

# Clarion®

## VDH910

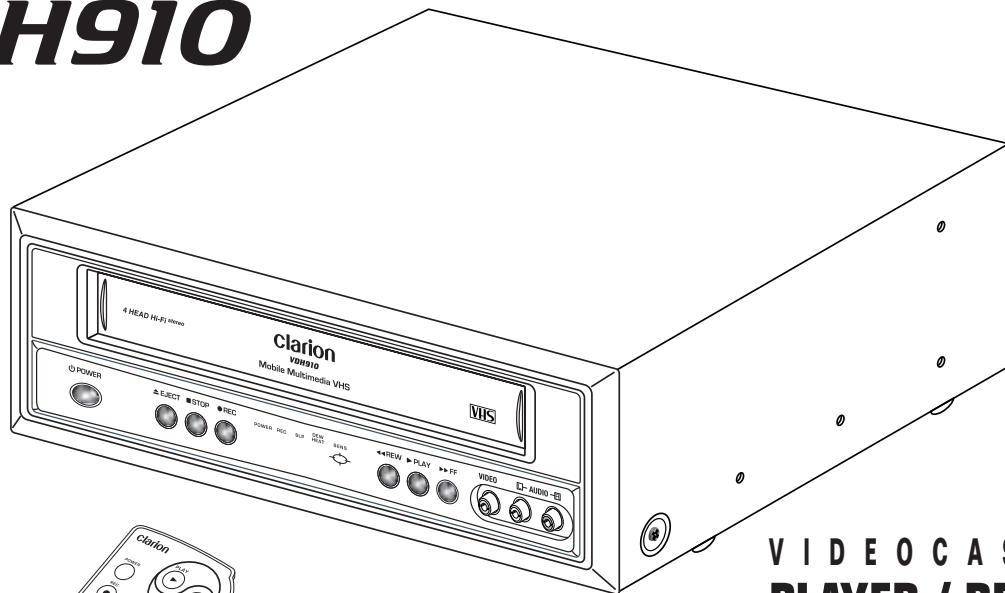

**VIDEO CASSETTE  
PLAYER / RECORDER**

**OWNER'S MANUAL  
INSTALLATION GUIDE**



**WARNING!**

**THE CLARION VDH910 MOBILE MULTIMEDIA VCR IS DESIGNED FOR REAR SEAT VIEWING OF VIDEOCASSETTES ONLY.**

**THIS PRODUCT IS NOT INTENDED FOR VIEWING BY THE DRIVER WHILE THE VEHICLE IS IN MOTION SINCE SUCH USE MAY DISTRACT THE DRIVER OR INTERFERE WITH THE DRIVER'S SAFE OPERATION OF THE VEHICLE AND MAY RESULT IN SERIOUS INJURY OR DEATH. SUCH USE MAY ALSO VIOLATE STATE LAW.**

**CLARION DISCLAIMS ANY LIABILITY FOR ANY BODILY INJURY, INCLUDING FATALITIES, OR PROPERTY DAMAGE THAT MAY RESULT FROM ANY IMPROPER OR UNINTENDED USES OF THIS PRODUCT.**

**ABOUT INSTALLATION**

Installation of mobile audio and video components requires experience with a variety of mechanical and electrical procedures. Even though this manual provides general installation and operation instructions for your new Clarion VDH910 Mobile Multimedia VHS, it does not show the exact installation methods for your particular vehicle.

If you do not have the required knowledge and experience to successfully complete the installation, we strongly recommend consulting an authorized Clarion Dealer about professional installation options.

**TABLE OF CONTENTS**

<b>Introduction.....</b>	<b>2</b>
<b>Care and Maintenance .....</b>	<b>3</b>
<b>Dew/Heat Sensor Operation .....</b>	<b>4</b>
<b>Description Of Rear Connectors.....</b>	<b>5</b>
<b>Description Of Controls and Indicators .....</b>	<b>6</b>
<b>Description Of Remote Control .....</b>	<b>8</b>
<b>Description of On-Screen Programming .....</b>	<b>10</b>
<b>Operating The VDH910 .....</b>	<b>14</b>
<b>Recording With The VDH910.....</b>	<b>16</b>
<b>Installation And Wiring.....</b>	<b>17</b>
<b>Troubleshooting .....</b>	<b>19</b>
<b>Specifications .....</b>	<b>20</b>
<b>FCC Statement .....</b>	<b>20</b>

## Clarion VDH910 VIDEOCASSETTE PLAYER/RECORDER

### INTRODUCTION

The Clarion VDH910 is a full-featured Mobile Multimedia player/recorder specifically created for the mobile environment. It is designed to work with Clarion Multimedia devices and Clarion Video Monitors for a complete video solution for your vehicle. The VDH910 includes the following features:

- **4-head VHS Hi-Fi stereo system** for high-quality playback of NTSC video and near CD-quality audio tracks.
- **Microprocessor-based**, full electronic-logic control system with feather-light push-button operation.
- **Motorized front-loading system** for fast videocassette loading and removal.
- **Built-in 12 Vdc operation** which eliminates the need to use power supply converters for mobile use.
- **Front A/V mounted RCA input jacks** that automatically switch to LINE2 input when plugged in.
- **Infrared Remote Control** standard for convenient wireless operation.
- **Diamond Like Carbon Head (DLC)** coated tape head drum for extended head durability while lessening tape

wear and tape cleaning requirements.

- **Special effect playback, including slow motion**, and 2-speed forward/reverse picture search for quick location of a desired video segment.
- **Digital Auto Tracking** for best picture quality. The VDH910 automatically adjusts tracking while playing a cassette.
- **Dew/Heat Protection System** to warn of condensation and high internal temperatures.

### ***About The Manual And Warranty***

To start enjoying your new Clarion VDH910, please read the remaining instructions listed in this manual. Keep all instructions for future reference. This product is covered by a limited warranty (see the enclosed warranty card). **Save the sales receipt to protect your purchase and aid in warranty service.**

### **CARE AND MAINTENANCE**

#### **VCR Care**

- Use a dry cloth when dusting your VCR.
- Take care of your remote control. Keep the remote with your cassettes, where it is unlikely to be lost or damaged.
- Keep liquids away from your VCR, including beverages and cleaning liquids. Spilling any liquid on the VCR can damage the electronics, resulting in an electrical shock or fire.
- If the unit or remote control should become wet, turn off all power and let your authorized Clarion Dealer clean or service the equipment.

**DO NOT ATTEMPT TO OPEN OR SERVICE THE UNIT OR REMOTE CONTROL. THE INTERNAL PARTS ARE NOT USER-SERVICEABLE. DOING SO WILL VOID THE WARRANTY.**

- Do not use liquid or aerosol cleaners that can accidentally get into the VCR causing damage or creating a fire hazard.

- Do not allow coins, cleaning cloths, papers and other objects to be pushed into the cassette slot. These objects could connect with a voltage point inside the VCR and cause an electrical shock, or may short out parts causing unit failure or fire.

#### **Head Cleaning**

Over time the picture may become blurred, interrupted, or noisy. If dirt has accumulated on the video heads the unit may require cleaning. You can verify this symptom by playing several different videocassettes. If the problem is the same, then the heads need to be cleaned. Please consult your nearest Clarion Dealer for recommendations on cleaning products and service.

#### **Operation Precautions**

- Do not subject the unit to direct sunlight or an extremely hot environment (e.g., closed windows on a hot summer day, direct path of heater vent, etc.).
- Avoid using the unit under the following conditions:
  - After extended parking on an extremely hot or cold day.
  - Near strong magnetic fields.

## Clarion VDH910 VIDEOCASSETTE PLAYER/RECORDER

- In an environment with excessive humidity, dust, or vibration (e.g., off-road travel, etc.).
- If the unit has accumulated moisture condensation (e.g., after parking the vehicle outside overnight), allow the unit to automatically remove it through a built-in Dew/Heat sensor. See *Dew/Heat Sensor Operation*.

### **Videocassette Use**

- Use only high quality VHS-type (T-30, T-60, or T-120) videocassettes that last longer and provide a better picture.
- Always rewind your videocassettes to help maintain tape quality and tape life.
- Do not directly touch the magnetic tape surface. Do not splice or disassemble a videocassette. Playing these cassettes may cause damage to the VCR or its tape heads.
- Avoid exposing a videocassette to direct sunlight and keep it away from heat sources (e.g., heater vent).
- Avoid extreme environments such as high humidity, excessive vibrations or jarring, strong magnetic fields (e.g., speaker magnet, etc.) and dust.
- Always place a videocassette back in its case after use.

### **DEW/HEAT SENSOR OPERATION**

The VDH910 is equipped with a built-in Dew/Heat circuit that automatically detects for moisture condensation and high internal temperature. When activated, the Dew/Heat Indicator will flash and “DEW/HEAT” is displayed on the TV screen. While active, the Dew/Heat Sensor circuit will inhibit the drive section to avoid damaging heads due to sticking tape or high internal temperatures that can cause tape damage. The unit will be powered on, but it will not accept a videocassette.

*NOTE: If a videocassette was left in the VDH910, press EJECT to avoid damaging the tape during this procedure.*

If moisture is the problem, leave the power on so the unit can warm up and dry any accumulated moisture. When the Dew/Heat Indicator stops flashing, the unit will return to full operation.

## DESCRIPTION OF REAR CONNECTORS

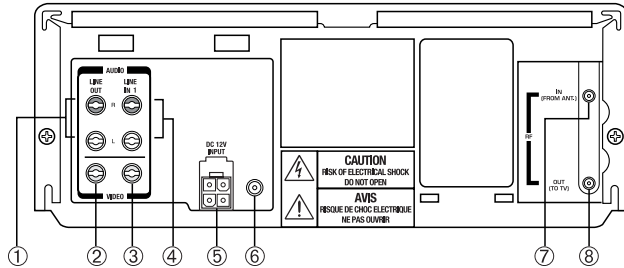

Figure 1. The VDH910's rear connections.

- ① **STEREO L/R OUTPUT (RCA Jacks)**  
Use a stereo RCA audio cable to connect stereo audio from the VDH910.
- ② **VIDEO OUT (RCA Jack)**  
Use an RCA video cable to connect video from the VDH910 to the Monitor.
- ③ **VIDEO IN LINE-1 (RCA Jack)**  
Use an RCA video cable to connect a video input signal to the VDH910. You can choose either LINE 1 or LINE

2 (Front AV Inputs) using the Remote control.

- ④ **STEREO IN L/R LINE-1 (RCA Jacks)**  
Use a stereo RCA audio cable to connect stereo audio from an alternate A/V source. You can choose either audio source LINE 1 or LINE 2 (Front A/V Inputs) using the Remote control.
- ⑤ **DC IN 12V (4-Pin Molex)**  
Use the supplied DC power cord to connect the VDH910 to the vehicle's 12-volt electrical system.
- ⑥ **REMOTE SENSOR INPUT (3.5 mm Plug)**  
Install and connect the remote mount IR Sensor (included) to the back of the VDH910 when the player is hidden away or mounted under a seat.
- ⑦ **RF INPUT (F-Connector)**  
Use with a 75 ohm antenna.
- ⑧ **RF OUTPUT (F-Connector)**  
Route to 75 ohm TV input.

# Clarion VDH910 VIDEOCASSETTE PLAYER/RECORDER

## DESCRIPTION OF CONTROLS AND INDICATORS

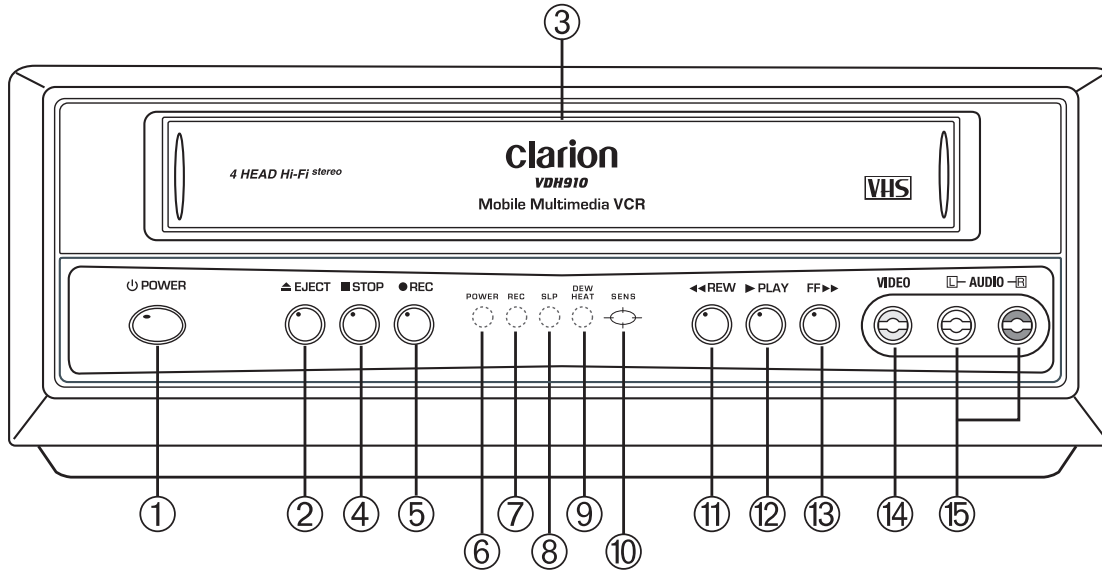

Figure 2. The VDH910's and IR Remote controls and indicators (see descriptions on the next page).



- ① **POWER Button**  
Press to power the unit ON or OFF.
- ② **EJECT Button**  
Press to eject a videocassette from the compartment.
- ③ **CASSETTE Compartment**  
Insert a videocassette which automatically loads the tape.
- ④ **STOP Button**  
Press to stop any play, fast forward, or rewind mode.
- ⑤ **RECORD Button**  
Engages the RECORD mode.
- ⑥ **POWER Indicator**  
Illuminates when the player is powered up.
- ⑦ **RECORD Indicator**  
Illuminates when RECORD mode is ON.
- ⑧ **SLP Indicator**  
Illuminates when playback is in Standard Long Play.
- ⑨ **DEW/HEAT Indicator**  
When illuminated and flashing the PLAY mode is disabled. Press the EJECT function to remove the internal cassette to prevent damage (see page 4).
- ⑩ **Remote IR Sensor opening**  
Allows the IR to function through the front of the player.
- ⑪ **REW Button**  
Press REW to rewind the tape. If PLAY is engaged, press REW to reverse search for a desired video segment.
- ⑫ **PLAY Button**  
Press button to play the videocassette.
- ⑬ **FF Button**  
Press FF to fast forward the tape. If PLAY is engaged, press FF to forward search for a desired video segment.
- ⑭ **Front A/V (LINE2) Video Input**  
Use an RCA video cable to connect video signal from an alternate A/V source. You can choose either video source LINE 2 or LINE 1 (Rear A/V Inputs) using the Remote control.
- ⑮ **STEREO IN L/R LINE-2 (Front RCA Jacks)**  
Use a stereo RCA audio cable to connect stereo audio from an alternate A/V source. You can choose either audio source LINE 2 or LINE 1 (Rear A/V Inputs) using the Remote control.

## Clarion VDH910 VIDEOCASSETTE PLAYER/RECORDER

### DESCRIPTION OF REMOTE CONTROL

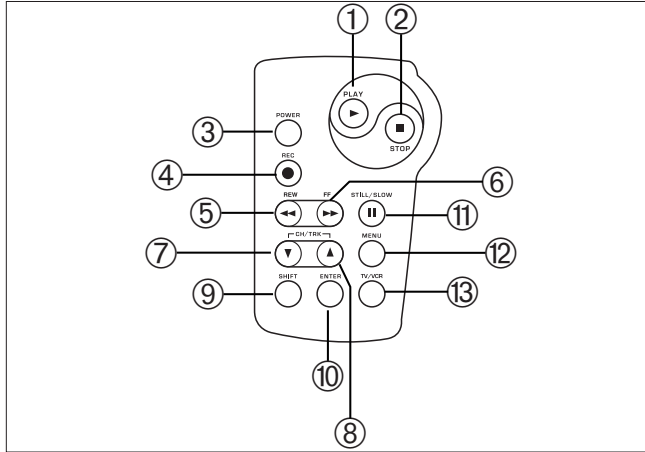

Figure 3. VDH910's Remote Control.

- ① **PLAY Button**  
Press button to play the videocassette.
- ② **STOP Button**  
Press to stop any play, fast forward, or rewind mode.
- ③ **POWER Button**  
Press to power the unit ON or OFF.
- ④ **RECORD Button**  
Engages the RECORD mode.
- ⑤ **FF Button**  
Press FF to fast forward the tape. If PLAY is engaged, press FF to forward search for a desired video segment.
- ⑥ **REW Button**  
Press REW to rewind the tape. If PLAY is engaged, press REW to reverse search for a desired video segment.
- ⑦ ⑧ **CHANNEL TRACK UP/DN Buttons**  
While in the TV tuner mode, changes TV Channels up or down. While in STILL mode, adjusts the tape tracking for still frame clarity.
- ⑨ **SHIFT Button**  
Toggles down the On-Screen Menu choice.
- ⑩ **ENTER Button**  
Toggles selection of the On-Screen Menu choices.

- ⑪ MENU Button  
Displays the On-Screen Menu, or changes and exits the On-Screen Menu.
- ⑫ STILL/SLOW Button  
Press once to pause for STILL frame. Press again to advance frame by frame. Press and hold button for SLOW motion playback.
- ⑬ TV/VCR Button  
Changes input source selection from VCR to TV tuner.

### Using The IR Remote Control

Inside the vehicle, simply aim the Remote Control directly at the VDH910's faceplate and press any desired button. When direct line of sight is impossible, install the remote mount IR Sensor in the front of the vehicle (*see page 14*). For best results, also note the following:

- Aim the Remote Control from no further than 7 feet away and no more than 3 feet on either side of the VDH910 faceplate or remote mount sensor.
- Direct sunlight or very bright light will reduce sensitivity to remote signal commands. Be sure the remote sensor is not located in direct sunlight.

- Objects between the VDH910 faceplate or the remote mounted IR sensor will interfere or block IR remote signal commands.

### Inserting Battery Into The IR Remote Control

1. Locate the battery compartment on the back of the IR Remote Control.
2. Remove the battery holder and insert one CR2025 battery (supplied), matching polarity as shown on the battery holder (positive side up).
3. Slide the battery holder back into the remote until it locks with a "click".

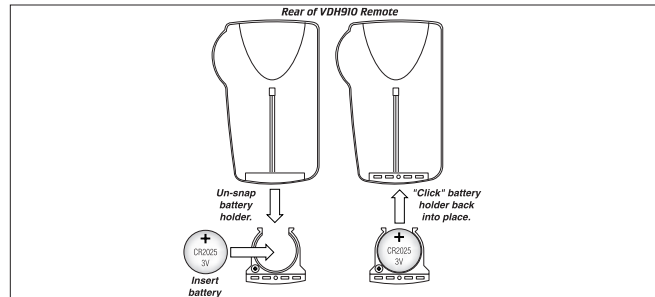

Figure 4. Battery Installation for the VDH910's Remote Control.

# Clarion VDH910 VIDEOCASSETTE PLAYER/RECORDER

## Using Manual Tracking

Using the Remote Control, you can adjust the picture tracking manually.

- Automatic tracking is initiated when you first insert a videocassette in the CASSETTE Compartment.
- Manual tracking may be used when auto tracking does not fully correct picture tracking noise. Press CH/TRK UP button to increase or CH/TRK DN button to decrease manual tracking.

*NOTE: If you reach the limit on either TRACKING + or - and notice no further improvement, the tape may be severely worn or the unit's heads may need cleaning.*

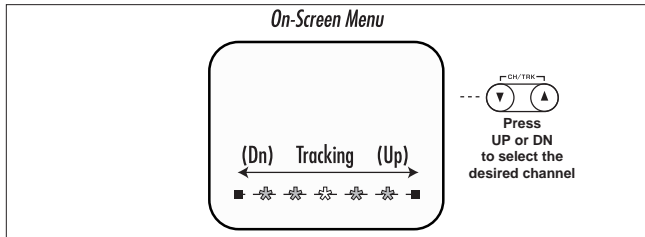
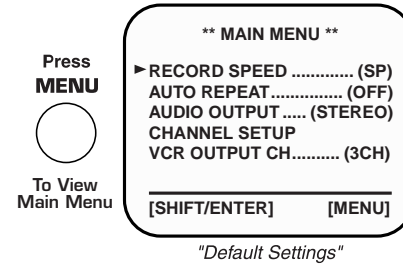

Figure 5. SHIFT functions on the VDH910's Remote Control.

## DESCRIPTION OF ON-SCREEN PROGRAMMING



"Default Settings"

Figure 6. Main Menu for On-Screen Programming.

1. Press MENU on your remote control. The Main Menu will appear on the screen.
2. Select the item you want to adjust using the SHIFT and the ENTER buttons on your remote. Press MENU to exit and store your selection.

If the main menu doesn't appear, make sure the video source is tuned to VDH910 output. If the VCR is in the TV tuner mode, press the TV/VCR button to view the menu.

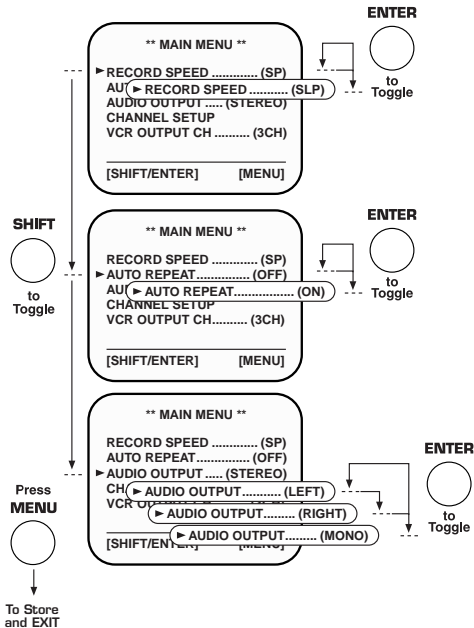

Figure 7. Record Speed, Auto Replay, and Audio Output screens for On-Screen Programming.

### **Record Speed (SP or SLP)**

The VDH910 can record at standard speed (SP) or a slower tape speed (SLP). Tapes recorded at standard speed provide a clearer picture, while the slower speed (SLP) allows more material on the tape (up to 6 hours).

### **Auto Repeat Play (ON)**

At the end of tape playback, the unit will rewind the tape to beginning and restart. This sequence will occur indefinitely until cancelled.

To temporarily cancel Auto Repeat Play, press any of tape function buttons while in this mode. The function will turn off for that cassette only.

Use the Remote Control to change the Auto Repeat Play in the On-Screen menu to turn this function OFF.

### **Audio Output Modes**

Using the Remote Control, select different audio modes when playing a Hi-Fi stereo videocassette.

Press ENTER one or more times to toggle to the appropriate audio playback and record choice.

## Clarion VDH910 VIDECASSETTE PLAYER/RECORDER

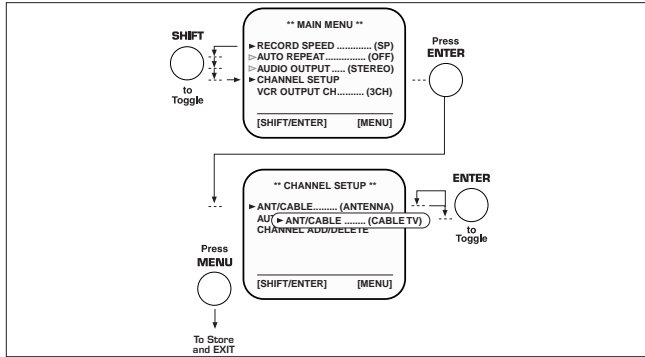

Figure 8. Antenna/Cable display for On-Screen programming.

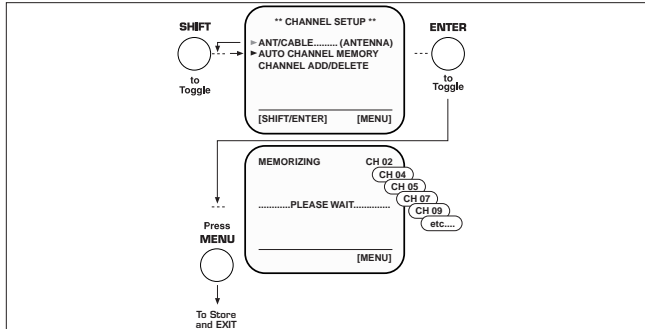

Figure 9. Auto Channel Memory for On-Screen programming.

### Channel Setup

When the VDH910 memorizes all available channels, you can use CH/TRK UP/DN to select channels. Use the SHIFT button on the remote control to toggle down to the Channel Setup function in the Main Menu.

### Setting the Source

Before memorizing all available channels, set the signal source for the VDH910's TV tuner.

- Select the Channel Setup function from the Main Menu then press the ENTER button.
- Use the SHIFT button to select either Antenna or Cable input (*with most Mobile Multimedia installations, we recommend using the Antenna mode*).

### Auto Channel Memory

The VDH910 automatically memorizes all available channels and stores them into the memory of the tuner.

- Select the Auto Channel Memory function from the Channel Setup Menu then press the ENTER button.

The tuner will begin scanning and memorizing all available channels. When finished, the channel numbers on the screen will stop.

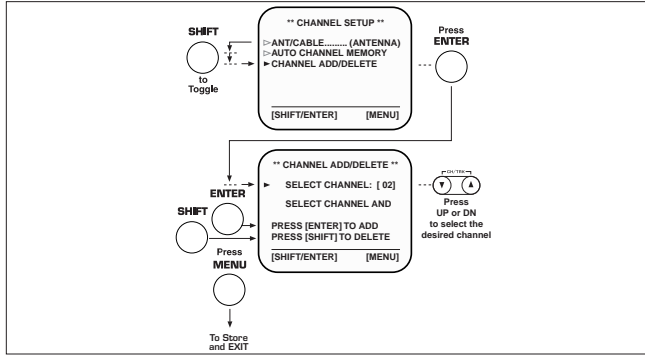

Figure 10. Channel Add/Delete for On-Screen programming.

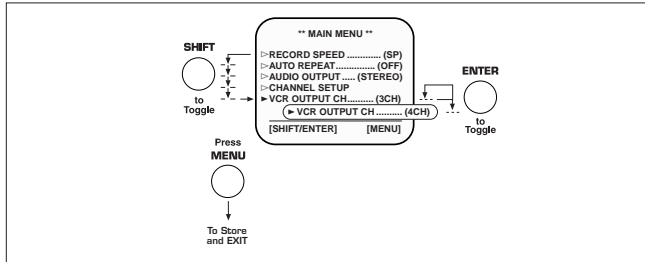

Figure 11. VCR Output Channel for On-Screen Programming.

*NOTE: Press the MENU button to interrupt the Auto Channel Memory function.*

### Channel Add/Delete

TV channels can be added or deleted from the tuner's memory using the Channel Add/Delete function.

- Select the Channel Add/Delete function from the Channel Setup Menu then press the ENTER button.
- Use the CH/TRK UP or DN buttons to select the desired channel. Press the ENTER button to add the channel, or press the SHIFT button to delete the channel.

*NOTE: The Auto Channel Memory function must be performed before the Channel Add/Delete will function.*

### VCR Output Channel

The VDH910 is equipped with 75 ohm F-Connectors that allow connection to normal composite video inputs on TVs. Set the output channel to Channel 3 or Channel 4, whichever is vacant in your area.

- Select the VCR Output Channel function from the Main Menu.
- Press the ENTER button to toggle between CH3 or CH4.

## Clarion VDH910 VIDEOCASSETTE PLAYER/RECORDER

### Description of Remote Eye

The VDH910 is supplied with an IR Remote Sensor which allows you to access all the features on the remote control when the VDH910 is mounted in another location away from the front panel sensor opening.

Mount the sensor in a convenient location. Run the sensor cable to the VDH910's location in the vehicle and simply plug the 3.5 mm jack into the rear of the VDH910.

*NOTE: The IR sensor mounted in some Clarion monitors, such as the VMA7191, can be connected directly to the remote sensor input to function as the remote eye for the system. (See page 18)*

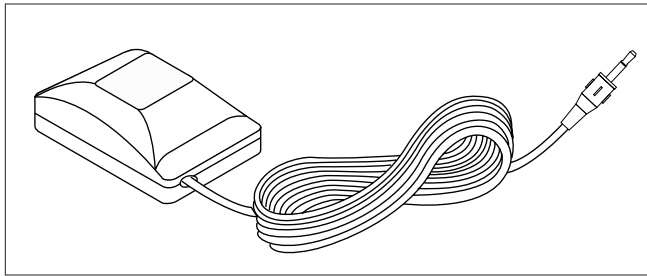

Figure 12 Supplied IR Sensor for the VDH910.

### OPERATING THE VDH910

#### Loading And Playing A Videocassette

- Gently insert a videocassette (with the labeled side up) into the CASSETTE compartment, as shown in *Figure 13*. The unit will automatically power on, load the tape, and automatically adjust tracking error, and sense if the tape is HI-FI.

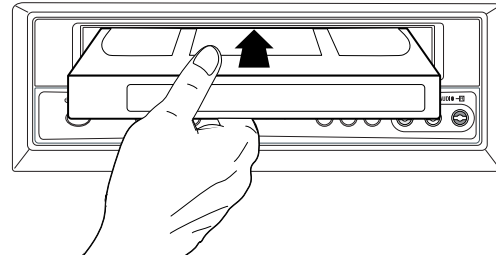

Figure 13 Loading a videocassette into the VDH910.

#### Using Rewind And Fast Forward

- To rewind the tape, first press STOP and then press REW, see *Figure 14* next page.
- To fast forward the tape, first press STOP and then press FF, see *Figure 14* next page.



- To cancel FF or REW, press PLAY or the STOP button.

### Using Forward And Reverse Search

The VDH910 includes a 2-speed forward/reverse picture search for quick location of a desired video segment at 7-times SP or 21-times SPL speed.

- To forward search the tape, press FF once (for 7-times SPL speed) or press and hold FF (for 21-times SPL speed) while the tape is playing. When you find the desired video

segment, press PLAY or release the FF button to cancel this function and resume playing the tape.

- To reverse search the tape, press REW once (for 7-times SPL speed) or press and hold REW (for 21-times SPL speed) while the tape is playing. When you find the desired video segment, press PLAY or release the REW button to cancel this function and resume playing the tape.

*NOTE: While in FF or REW Jet Search, audio signals are muted. If streaks, blurring, or horizontal jitters occur, adjust the picture using the CH/TRK buttons on the remote control.*

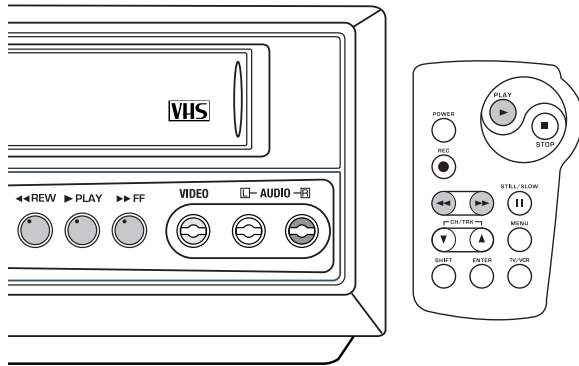

Figure 14. REW, PLAY, and FF on the VDH910 Remote Control.

### Still and Frame Advance

Press the STILL/SLOW button once to stop on a single frame. Press the STILL/SLOW button repeatedly to advance one frame at a time. Press PLAY to resume normal viewing.

### Slow Motion Playback

While in the Still mode, press and hold the STILL/SLOW button for 2 seconds for Slow Motion Playback. Press PLAY to resume normal viewing.

## Clarion VDH910 VIDEOCASSETTE PLAYER/RECORDER

### **RECORDING WITH THE VDH910**

#### **Recording from the TV tuner**

- Insert a videocassette (with the record protect safety tab intact) into the CASSETTE compartment, as shown in *Figure 13* on page 14.
- Check for the proper tape speed which is set in the Main Menu. Confirm that the VCR indicator is not illuminated on the front panel. If not, press the TV/VCR button on the remote control.
- Select a channel to record from the tuner by pressing the CH/TRK UP/DN buttons on the remote control.
- Press REC on the remote control or the front panel of the VDH910. The REC indicator should illuminate on the front panel.

*NOTE: If you want to edit out unwanted material during recording, press the STILL button to pause recording. To resume recording, press the STILL button again.*

- To stop recording, press the STOP button.

#### **Record Protect Tab**

Before recording on any video cassette, make sure the record protect safety tab is present. To prevent accidental recording

over a cassette tape, remove the record protection tab on the cassette. To record on a tape with its tab removed, cover the hole with adhesive tape.

#### **Recording from Line 1 or Line 2 Inputs**

- Insert a videocassette (with the record protect safety tab intact) into the CASSETTE compartment, as shown in *Figure 13* on page 14.
- Check for the proper tape speed which is set in the Main Menu. Confirm that the VCR indicator is illuminated on the front panel. If not, press the TV/VCR button on the remote control.
- Select the proper input line to record by pressing the CH UP/DN buttons on the remote control to change between LINE1 or LINE2.
- Press REC on the remote control or the front panel of the VDH910. The REC indicator should illuminate on the front panel.

*NOTE: If you want to edit out unwanted material during recording, press the STILL button to pause recording. To resume recording, press the STILL button again.*

- To stop recording, press the STOP button.

**INSTALLATION AND WIRING**

**Installing The VDH910**

The VDH910 can be mounted horizontally or vertically, as shown in *Figures 15 and 16*.

*NOTE: For best results, Clarion recommends horizontal mounting, since vertical mounting may produce increased picture jitter while the vehicle is moving.*

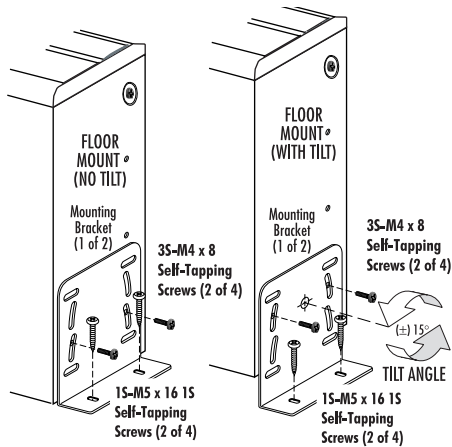

Figure 15. Vertical mounting of VDH910.

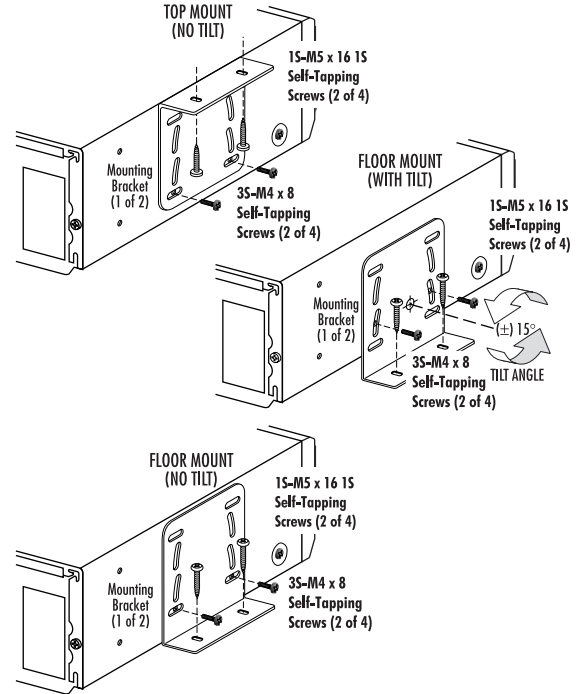

Figure 16. Horizontal mounting of VDH910.

# Clarion VDH910 VIDEOCASSETTE PLAYER/RECORDER

## Wiring The VDH910 Videocassette Player

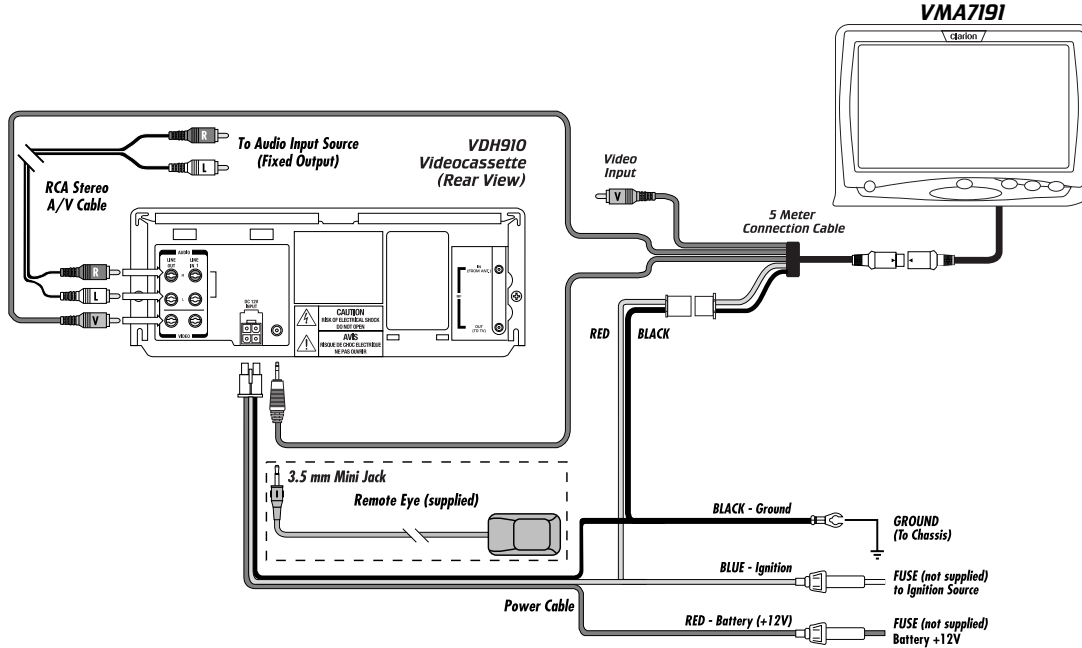

Figure 17. Wiring diagram for VDH910.

**TROUBLESHOOTING**

<b>Symptom</b>	<b>Cause</b>	<b>Solution</b>	<b>Symptom</b>	<b>Cause</b>	<b>Solution</b>
Unit does not work.	No power.	Verify power wiring to unit ( <i>see page 18</i> ).  Check the Remote for a good battery.	Picture is noisy	Videocassette is worn.  Tracking is not set optimally.	Eject videocassette and play another.  Adjust tracking ( <i>see page 10</i> ).
Videocassette does not insert into unit.	Another tape is already in unit.  Dew/Heat Sensor is on.	Eject first video cassette and insert a second tape.  Leave power on to unit. ( <i>see page 4</i> ).	Videocassette does not insert into unit.	Video heads are dirty.  Another tape is already in unit.	Clean unit – see your Clarion dealer.  Eject first video cassette and insert a second tape.
Pressing POWER will not turn unit off.	Unit is in Auto Play and buttons are inoperable ( <i>see page 11</i> ).	Go to Auto Repeat in the On-Screen function and turn that function off.		Dew/Heat Sensor is activated.	Leave power on to unit. ( <i>see page 4</i> ).
Tape will not rewind or fast forward.	Tape is fully rewound or at beginning.	Eject videocassette and check tape position.	Hi-Fi indicated but sound is mono.	Videocassette recorded by stereo recorder in mono.	Play a videocassette that has a Hi-Fi stereo soundtrack.
			Videocassette sounds mono.	Unit is set to mono in Audio Output mode.	Use Remote buttons to change audio modes ( <i>see page 11</i> ).

## **Clarion VDH910 VIDEOCASSETTE PLAYER/RECORDER**

### **SPECIFICATIONS**

#### **General Specifications**

Power Requirement:	12 V DC
Power Consumption:	12 watts, Power On
Weight:	5.3 lb (2.4 kg)
Dimensions ( <i>w x h x d</i> ):	10.4 x 3.7 x 10.2 in. (265 x 92.5 x 265 mm)

#### **Tape Deck Specifications**

Format:	VHS 1/2 inch (12.7 mm) Standard
Scanning System:	Standard NTSC
Recording System:	Rotary Double azimuth four-head helical scanning system
Video heads:	DA-4 rotary heads
Audio heads:	Linear; 1 stationary Hi-Fi; 2 rotary
Control head:	1 stationary
Erase head:	1 full track, 1 audio track
Antenna input/output terminals:	UHF/VHF: 75 ohms F-Connector
Recording/playback System:	Recording: VHS format (SP, SLP) Playback: VHS format (SP, LP, SLP)
Record/Play Time:	6 hours with T-120 on SLP speed

FF/REW Time (T-120):	Approx. 2 minutes and 20 seconds
Supplied Accessories:	IR Remote Control, (1) 5 Meter A/V Cable, 4-pin Power Cable, (8) 3S-M4 Self-Tapping Screws, (16) 1S-M5 Self-Tapping Screws, (2) Installation Brackets, and Remote IR Sensor.

#### **Channel List**

On Air	12 VHF (Channels 2-13) 56 UHF (Channels 14-69)
--------	---

#### **FCC STATEMENT**

This equipment has been tested and found to comply with the limits for a Class B digital device, pursuant to Part 16 of the FCC Rules. These limits are designed to provide reasonable protection against harmful interference in a residential installation. This equipment generates, uses, and can radiate radio frequency energy and, if not installed and used in accordance with the instructions, may cause harmful interference to radio communications. However, there is no guarantee that interference will not occur in a particular installation.

If this equipment does cause harmful interference to radio or television reception, which can be verified by turning the unit off and on, the user is encouraged to consult the dealer or an experienced radio/television technician for help.



**Clarion Corporation of America**

661 West Redondo Beach Blvd  
Gardena, CA 90247  
800-Go-Clarion  
[www.clarion-usa.com](http://www.clarion-usa.com)