

COBY®

Micro-Clip MP3 Player with
Random Playback

MP550-1G



MP550-2G



Instruction Manual

Please read this manual carefully before operation

Precautions

	CAUTION WARNING: SHOCK HAZARD, DO NOT OPEN. AVIS: RISQUE DE CHOC ELECTRIQUE. NE PAS OUVRIIR	
CAUTION: TO REDUCE THE RISK OF FIRE AND ELECTRIC SHOCK, DO NOT REMOVE THE COVER (OR BACK) OF THE UNIT. REFER SERVICING ONLY TO QUALIFIED SERVICE PERSONNEL.		



The lightning flash with arrowhead symbol within an equilateral triangle is intended to alert the user to the presence of uninsulated "dangerous voltage" within the product's enclosure that may be of sufficient magnitude to constitute a risk of electric shock.



The exclamation point within an equilateral triangle is intended to alert the user to the presence of important operation and servicing instructions in the literature accompanying the appliance.

For Customer Use:

Enter below the serial number that is located on the rear of the unit. Retain this information for future reference.

Model No. _____

Serial No. _____

WARNING: To prevent fire or shock hazard, do not expose this device to rain or moisture. Dangerous high voltage is present inside the enclosure. Do not open the cabinet.

CAUTION: To prevent electric shock, match wide blade of plug to wide slot of outlet and fully insert.

WARNING: Handling the cords on this product will expose you to lead, a chemical known to the State of California to cause cancer, and birth defects or other reproductive harm. **Wash hands after handling.**

Precautions

NOTICE:

This product is protected by certain intellectual property rights of Microsoft. Use or distribution of such technology outside of this product is prohibited without a license from Microsoft.

Content owners use Windows Media digital rights management technology (WMDRM) to protect their intellectual property, including copyrights. This device uses WMDRM software to access WMDRM-protected content. If the WMDRM software fails to protect the content, content owners may ask Microsoft to revoke the software's ability to use WMDRM to play or copy protected content. Revocation does not affect unprotected content. When you download licenses for protected content, you agree that Microsoft may include a revocation list with the licenses. Content owners may require you to upgrade WMDRM to access their content. If you decline an upgrade, you will not be able to access content that requires the upgrade.

NOTICE:

Please refer to the packaging for this product for the technologies supported by the product.

Windows Media® is a registered trademark of Microsoft Corporation.

USB® is a registered trademark of USB Implementers Forum, Inc.

All trademarks, registered trademarks and logos are of their respective holders.

Protect your hearing: Hearing experts advise against the constant use of personal stereos played at high volume. Constant exposure to high volumes can lead to hearing loss. If you should experience ringing in the ears or hearing loss, discontinue use and seek medical advice.



For recycling or disposal information about this product, please contact your local authorities or the Electronics Industries Alliance: www.eiae.org.

Precautions

FCC Statement:

This device complies with Part 15 of the FCC Rules. Operation is subject to the following two conditions:

- (1) This device may not cause harmful interference, and
- (2) This device must accept any interference received, including interference that may cause undesired operation.

Note: This equipment has been tested and found to comply with the limits for Class B digital devices, pursuant to Part 15 of the FCC rules. These limits are designed to provide reasonable protection against harmful interference in a residential installation. This equipment generates, uses and can radiate radio frequency energy and, if not installed and used in accordance with the instructions, may cause harmful interference to radio communications. However, there is no guarantee that interference will not occur in a particular installation. If this equipment does cause harmful interference to radio or television reception, which can be determined by turning the equipment off and on, the user is encouraged to try to correct the interference by one or more of the following measures:

- Reorient or relocate the receiving antenna.
- Increase the separation between the equipment and receiver.
- Connect the equipment into an outlet on a circuit different from that to which the receiver is connected.
- Consult the dealer or an experienced radio/TV technician for help

Use of shielded cable is required to comply with Class B limits in Subpart B of Part 15 of the FCC rules.

Do not make any changes or modifications to the equipment unless otherwise specified in the manual. If such changes or modifications should be made, you could be required to stop operation of the equipment.

Important Safety Instructions

1. **Read Instructions:** All the safety and operating instructions should be read before the product is operated.
2. **Retain Instructions:** The safety and operating instructions should be retained for future reference.
3. **Heed Warnings:** All warnings on the product and in the operating instructions should be adhered to.
4. **Follow Instructions:** All operating and usage instructions should be followed.
5. **Cleaning:** Unplug this product from the wall outlet before cleaning. Do not use liquid cleaners or aerosol cleaners. Use a damp cloth for cleaning.
6. **Attachments:** Use only attachments recommended by the manufacturer. Use of other attachments may be hazardous.
7. **Water and Moisture:** Do not use this product near water (e.g., near a bath tub, washbowl, kitchen sink, laundry tub, in wet basements, or near a swimming pool and the like).

8. **Accessories:** Do not place this product on an unstable cart, stand, tripod, bracket, or table. Use only with carts, stands, tripods, brackets, or tables recommended by the manufacturer or sold with the product. Any mounting of the product should follow the manufacturer's instructions and should use a mounting accessory recommended by the manufacturer.



A product and cart combination should be moved with care. Quick stops, excessive force, and uneven surfaces may cause the product and cart combination to overturn.

9. **Ventilation:** Slots and openings in the cabinet are provided for ventilation to ensure reliable operation of the product and to protect it from overheating. These openings should never be blocked by placing the product on a bed, sofa, rug, or other similar surface. This product should not be placed in a built-in installation such as a bookcase or rack unless proper ventilation is provided or the manufacturer instructions have been adhered to.
10. **Power Sources:** This product should be operated only from the type of power source indicated on the rating label. If you are not sure of the type of power supply to your home, consult your product dealer or local power company. For products intended to operate from battery power or other sources, refer to the operating instructions.
11. **Grounding or Polarization:** This product may be equipped with a polarized alternating-current line plug that has one blade wider than the other.

Important Safety Instructions

This plug will only fit into the power outlet in one direction. This is a safety feature. If you are unable to insert the plug fully into the outlet, try reversing the direction of the plug. If the plug should still fail to fit, contact an electrician to replace the obsolete outlet. Do not defeat the safety purpose of the polarized plug.

12. **Power-Cord Protection:** Power supply cords should be routed so that they are not likely to be walked on or pinched by items placed upon or against them, paying particular attention to cords at plugs, convenience receptacles, and at the point which they exit from the product.
13. **Protective Attachment Plug:** The product may be equipped with an attachment plug with overload protection. This is a safety feature. See the operating instructions for replacement or directions to reset the protective device. If replacement of the plug is required, be sure the service technician has used a replacement plug that has the same overload protection as the original plug as specified by the manufacturer.
14. **Outdoor Antenna Grounding:** If an outside antenna is connected to the product, be sure the antenna system is grounded so as to provide some protection against voltage surges and built-up static charges. Article 810 of the National Electrical Code, ANS/NFPA 70 provides information with regard to proper grounding of the mast and supporting structure, grounding of the lead-in wire to an antenna-discharge unit, size of grounding conductors, location of antenna-discharge unit, connection to grounding electrodes, and requirements for the grounding electrode (see figure).

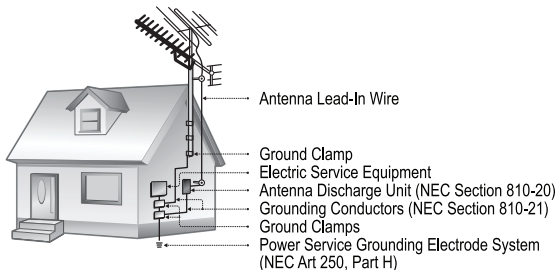

15. **Lightning:** For added protection for this product, unplug it from the wall outlet and disconnect the antenna or cable system during a lightning storm or when it is left unattended and unused for long periods of time. This will prevent damage to the product due to lightning or power-line surges.

Important Safety Instructions

16. **Power Lines:** An outside antenna system should not be located in the vicinity of overhead power lines or other electric light or power circuits, or where it can fall into such power lines or circuits. When installing an outside antenna system, extreme care should be taken to keep from touching such power lines or circuits, as contact with them might be fatal.
17. **Overloading:** Do not overload wall outlets, extension cords, or integral convenience receptacles as this can result in a risk of fire or electric shock.
18. **Object and Liquid Entry:** Never push objects of any kind into this product through openings as they may touch dangerous voltage points or short-out parts that could result in a fire or electric shock. Never spill liquid of any kind on the product.
19. **Servicing:** Do not attempt to service this product yourself as opening or removing covers may expose you to dangerous voltage or other hazards. Refer all servicing to qualified service personnel.
20. **Damage Requiring Service:** Unplug this product from the wall outlet and refer servicing to qualified service personnel under the following conditions: a) when the power-supply or plug is damaged; b) if liquid has been spilled or if objects have fallen into the product; c) if the product has been exposed to rain or water; d) if the product does not operate normally by following the operating instructions. Adjust only those controls that are covered by the operating instructions as improper adjustment of other controls may result in damage and will often require extensive work by a qualified technician to restore the product to its normal operation; e) if the product has been dropped or damaged in any way; f) when the product exhibits a distinct change in performance—this indicates a need for service.
21. **Replacement Parts:** When replacement parts are required, be sure that your service technician has used replacement parts specified by the manufacturer or have the same characteristics as the original part. Unauthorized substitutions may result in fire, electric shock, or other hazards.
22. **Safety Check:** Upon completion of any service or repairs to this product, ask the service technician to perform safety checks to ensure that the product is in proper operating condition.
23. **Wall or Ceiling Mounting:** The product should be mounted to a wall or ceiling only as recommended by the manufacturer.
24. **Heat:** The product should be situated away from heat sources such as radiators, heat registers, stoves, or other products (including amplifiers) that produce heat.

Table of Contents

PRECAUTIONS	2
IMPORTANT SAFETY INSTRUCTIONS	5
TABLE OF CONTENTS	8
PACKAGE CONTENTS	9
FEATURES	10
GETTING STARTED	11
Controls at a Glance	11
Powering Your Player	12
Charging Your Player.....	12
Turning Your Player On/Off	13
Locking/Unlocking Your Player's Keys (Hold)	13
PLAYING MUSIC	14
Music Playback Controls.....	14
Random Playback (Shuffle)	15
CONNECTING TO A COMPUTER	16
Transferring/Managing Files	16
Disconnecting from a Computer	17
WINDOWS MEDIA PLAYER	19
FIRMWARE UPGRADES	20
TROUBLESHOOTING	21
SPECIFICATIONS	24

Package Contents

Please make sure that the items shown below are included in the package. Should an item be missing, please contact the local retailer from which you purchased this product.

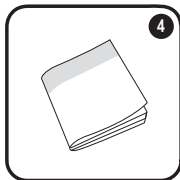
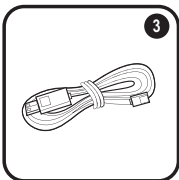







1. MP550
2. Stereo Earphones
3. USB Cable
4. Instruction Booklet

Features

- ✦ Integrated flash memory
- ✦ Plays MP3 and WMA digital music files
- ✦ Random (shuffle) music playback
- ✦ Hold feature prevents accidental key presses
- ✦ Mobile data storage function
- ✦ USB 2.0 for fast file transfers
- ✦ Integrated rechargeable battery

Getting Started

Controls at a Glance

1. Play/Pause:
Press Joystick 
Power On/Off:
Press and Hold Joystick 
2. Volume Up 
3. Previous/Reverse 
4. Next/Forward 
5. Volume Down 
6. LED Status Indicator
7. Headphone Output Jack
8. USB Port
9. Random Switch
10. Hold Switch

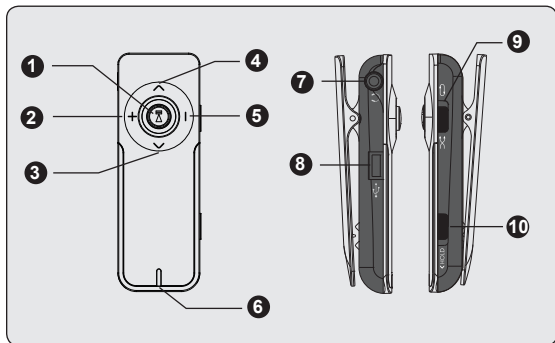

Getting Started

Powering Your Player

Your player has an integrated rechargeable battery. Typical music playtime is up to 5 hours.



Upon initial use, the battery should be charged fully (12 hours) to ensure optimal performance and battery life.

Music play time is an estimated value. Actual play time may vary depending on encoding method used and other factors.

Charging Your Player

Your player can be charged through a PC USB connection. Plug one end of the USB cable into the player's USB Port and plug the other end into the USB port of a powered-on computer.



If the player is connected to a computer through a USB hub, the hub must be self-powered to charge the player's battery.

File transfers will extend the charging time.





The battery used in this device may present a fire or chemical burn if mistreated. Do not disassemble, incinerate, or heat the battery.

Do not connect the player to a power source other than that which is indicated here or on the label as this may result in the risk of fire or electric shock.

Getting Started

Turning Your Player On/Off

- ✦ To turn your player on, hold  until the LED indicator lights up.
- ✦ To turn your player off, hold  until the LED indicator darkens.

Locking/Unlocking Your Player's Keys (Hold)









When engaged, the Key Lock feature disables your player's controls to prevent accidental key presses when it is in your pocket or bag.

- ✦ To lock the player, slide the HOLD switch to the left in the direction of the "HOLD >" symbol.
- ✦ To unlock the player, slide the HOLD switch to the right in the direction away from the "HOLD >" symbol.

Playing Music

Music Playback Controls

Use the following controls during music playback. The LED indicator will flash during music playback.

Key Action	Function
Press 	Start/Pause music playback. While playback is paused, press  to resume.
Press 	Play the previous track.
Press 	Play the next track.
Hold 	Reverse through the current track.
Hold 	Fast-forward through the current track.
Press 	Decrease the volume level.
Press 	Increase the volume level.





For more information about how to get music onto your player, please refer to the section "Connecting to a Computer > Transferring Files".

For more information about digital MP3 and WMA music files, please visit our website at www.cobyusa.com.

Playing Music

Random Playback (Shuffle)

Your player can play all music files on your player in Normal (repeat) or Random order.

- ✦ To play tracks in normal (repeat) order, set the RANDOM switch to the Repeat [] position.
- ✦ To play tracks in random order, set the RANDOM switch to the Random [] position.

Connecting to a Computer

Connect the Coby player to a computer with the USB cable provided to:

- ✦ Transfer files to and from your player
- ✦ Perform basic file management functions.

Upon connection:

- ✦ Your computer will automatically recognize the player as a Removable Disk. An icon representing your player will appear under “Devices with Removable Storage” when you open “My Computer”.
- ✦ It may take Windows several minutes to recognize and set up the device the first time it is connected depending on your hardware configuration.



If you are using Windows 98 SE, you may need to install a USB driver on your computer. Please download and install the driver from the COBY website at: www.cobyusa.com/?p=ware.

Transferring/Managing Files

The USB 2.0 connection makes it easy to transfer music quickly between the player and your computer. Simply use the player as you would any removable disk using basic operating system commands.

You can also use your player to store video, photo, or any other type of files.

Connecting to a Computer

If you need further assistance with transferring and managing files, please refer to your operating system's instruction manual or on-screen help. If you are using media management software such as iTunes, Winamp, or Windows Media Player, please refer to their documentation for support.



Do not disconnect or otherwise interrupt the player during file transfer—this could damage or corrupt the player's firmware or your files.



For more information and support regarding music transfer and synchronization with Windows Media Player (WMP), please see the help section included with WMP (click "Help > Synchronizing Content to Devices").

Disconnecting from a Computer

Disconnect your player as instructed below to prevent data loss or file/firmware corruption.

Microsoft Windows

1. Double-click the green arrow icon in the taskbar located on the lower-right side of the computer screen (Safely Remove Hardware).



Connecting to a Computer

- 2. Safely Remove Hardware:**
Select “USB Mass Storage Device” from the list that appears and then click on “Stop”.

Stop a Hardware Device:

Select “USB Mass Storage Device” from the list that appears and then click on “OK”.



- 3.** When the “Safe to Remove Hardware” window appears, click the OK button and disconnect the USB cable from the player and your computer.

Macintosh OS X

- 1.** On the left side of the Finder Window, identify the appropriate Removable Disk icon.
- 2.** Click on the “Eject” arrow on the right of the Removable Disk icon.
- 3.** Disconnect the USB cable from the player and your computer.



Windows Media Player

You can use Windows Media Player and a USB connection to manage your music media library with Microsoft Windows XP or newer.

The latest version of Windows Media Player can be downloaded from the Microsoft website:

www.microsoft.com/windows/windowsmedia/default.msp

Please refer to the Quick Start Guide included with your player for more information.



For more information and support regarding music transfer and synchronization with Windows Media Player (WMP), please see the help section included with WMP (click “Help > Synchronizing Content to Devices”).

Firmware Upgrades

From time to time, COBY may release firmware upgrades to improve the performance of the Player or to add additional features. Please check the COBY website periodically at www.cobyusa.com to see if new firmware has been released for your player. If you are experiencing abnormal behavior with your player, you may choose to restore (format) your player before updating its firmware.



Do not interrupt the firmware upgrade process—doing so could damage your player and render it inoperable.

See the documentation that is included with the firmware upgrade file for detailed instructions.

Troubleshooting

If you have a problem with this device, please read the troubleshooting guide below and check our website at www.cobyusa.com for Frequently Asked Questions (FAQs) and firmware updates. If these resources do not resolve the problem, please contact Technical Support.

Address	COBY Electronics Technical Support 56-65 Rust Street Maspeth, NY 11378	
Email	techsupport@cobyusa.com	
Web	www.cobyusa.com	
Phone	800-727-3592:	Weekdays 8:00AM–11:00PM EST Weekends 9:00AM–5:30PM EST
	718-416-3197:	Weekdays 8:00AM–5:30PM EST

The player does not turn on.

- ✦ Ensure that the player is fully charged. Try charging the player overnight (8 hours).
- ✦ Ensure that the Hold/Lock switch is disengaged.

The buttons do not work.

- ✦ Ensure that the player is fully charged. Try charging the player overnight (8 hours).
- ✦ Ensure that the Hold/Lock switch is disengaged.

I cannot transfer files to the player.

- ✦ Ensure that your computer is running a supported operating system.

Troubleshooting

- ✦ If using a USB extension cable, ensure that it is securely attached to the player and the PC, or try using another USB cable.
- ✦ If you have connected the player through a USB hub, try connecting the player directly to your computer.
- ✦ Ensure that the player's memory capacity is not full.
- ✦ Ensure that the Hold/Lock switch is disengaged.

There is no sound during playback.

- ✦ Check the volume level.
- ✦ Ensure that the headphones are attached securely to the player.

The sound quality of the music is poor.

- ✦ Try playing the file on your computer. If the sound quality is still poor, try downloading the file again or re-encoding the file yourself.
- ✦ Ensure that the bit rate of the file is not too low. The higher the bit rate of the file, the better it will sound. The minimum recommended bitrate is 128kbps for MP3s and 96kbps for WMAs.
- ✦ Try lowering the volume of the player.
- ✦ Ensure that the headphones are attached securely to the player.

Troubleshooting

The player will not play my music file.

- ✦ Ensure that the file is in a compatible format.
- ✦ The file may be copy-protected and you no longer have authorization to play this file. If you feel this is in error, please contact the service from which you downloaded the file.

The player has malfunctioned.

- ✦ Try updating the player's firmware. Please refer to the Firmware Upgrades section of this manual for instructions.

Specifications

Display Type	LED Indicator
Memory	Integrated Memory MP550-1G: 1GB Flash MP550-2G: 2GB Flash
Audio Format Support	MP3, WMA (>64kbps, Class 1)
DRM Support	--
Song Info Support	--
PC Interface	USB 2.0 Hi-Speed (MSC)
Plug and Play Support	Windows 98SE/2000/ME/XP or newer Mac OS X
Audio Output	3.5mm Stereo (Headphone)
Signal-to-Noise Ratio	90dB
Frequency Response	20Hz - 20kHz
Power Supply	Rechargeable Lithium-ion Battery USB Charge
Unit Dimensions	2.52" x 0.86" x 0.34" (WHD)

Specifications, design, and manual are subject to change without notice.

Notes

Notes

Notes

Coby Electronics Corporation

56-65 Rust Street
Maspeth, NY 11378

www.cobyusa.com

www.ecoby.com

Coby is a registered trademark of
Coby Electronics Corporation.

Printed in China.

5501GAL
5502GAL