

SONY[®]

User guide

Xperia[™] T
LT30p

Contents

Xperia™ T User guide.....	6
Getting started.....	7
About this User guide.....	7
Android™ – what and why?.....	7
Phone overview.....	7
Assembly.....	9
Turning the device on and off.....	9
Locking and unlocking the screen.....	10
Setup guide.....	11
Accounts and services.....	11
Getting to know your device.....	13
Using the keys.....	13
Using the touchscreen.....	13
Battery.....	15
Lock screen.....	18
Home screen.....	18
Taking a screenshot.....	21
Accessing and using applications.....	21
Status and notifications.....	23
Accessing settings.....	25
On-screen keyboard.....	26
Phonepad.....	27
Entering text using voice input.....	27
Editing text.....	28
Personalising the Xperia keyboard.....	28
Customising your device.....	29
Memory.....	31
Using a headset	33
Internet and messaging settings.....	33
Controlling data usage.....	34
Mobile network settings.....	35
Downloading applications.....	37
Downloading applications from Google Play™.....	37
Downloading applications from other sources.....	37
Calling.....	38
Making calls.....	38
Receiving calls.....	39
Ongoing calls.....	40
Using the call log.....	40

Forwarding calls.....	41
Restricting calls.....	41
Multiple calls.....	41
Conference calls.....	42
Voicemail.....	42
Emergency calls.....	43
Contacts.....	44
Transferring contacts.....	44
Searching and viewing contacts.....	45
Adding and editing contacts.....	46
Favourites and groups.....	47
Sending contact information.....	47
Avoiding duplicate entries in the Contacts application.....	47
Backing up contacts.....	48
Messaging and chat.....	49
Reading and sending messages.....	49
Organising your messages.....	50
Calling from a message.....	51
Messaging settings.....	51
Instant messaging and video chat.....	51
Email.....	53
Setting up email.....	53
Sending and receiving email messages.....	53
Email preview pane.....	54
Organising your email messages.....	55
Email account settings.....	56
Gmail™.....	56
Music.....	57
Transferring music to your device.....	57
Listening to music.....	57
WALKMAN home screen	58
Playlists.....	59
Sharing music.....	60
Enhancing the sound.....	61
Visualiser	61
Recognising music with TrackID™.....	61
Music Unlimited online service.....	63
FM radio.....	64
Listening to the radio.....	64
Favourite radio channels.....	65
Sound settings.....	65

Camera	66
Taking photos and recording videos.....	66
Face detection.....	67
Using Smile Shutter™ to capture smiling faces.....	67
Adding the geographical position to your photos.....	68
General camera settings.....	68
Still camera settings.....	69
Video camera settings.....	72
Album	74
Viewing photos and videos.....	74
Sharing and managing photos and videos.....	75
Editing photos with the Photo editor application.....	76
Photo albums.....	77
Viewing your photos on a map.....	78
Movies	80
Watching videos in the Movies application.....	80
Transferring video content to your device.....	81
Managing video content.....	81
Video Unlimited	82
Video Unlimited service.....	82
Web browser	83
Browsing the web.....	83
Connectivity	84
Connecting to wireless networks.....	84
Sharing content with DLNA Certified™ devices.....	87
NFC.....	89
Bluetooth® wireless technology.....	91
Connecting your device to a computer.....	94
Connecting your device to a TV set using a cable.....	97
Screen mirroring.....	97
Scanning barcodes with the NeoReader™ application.....	98
Smart Connect.....	98
Synchronising data on your device	100
About synchronising data on your device.....	100
Synchronising with Google™ services.....	100
Synchronising with Microsoft® Exchange ActiveSync®.....	100
Synchronising with Facebook™.....	101
Maps and locations	103
Location services and sources.....	103
Using GPS.....	103
Google Maps™.....	104

Calendar and alarm clock.....	105
Calendar.....	105
Alarm clock.....	105
Support and maintenance.....	108
Updating your device.....	108
Backup and restore application.....	109
Resetting your device.....	110
Locking and protecting your device.....	111
Finding your device.....	113
Support application.....	114
Recycling your device.....	114
Reference.....	115
Status and notification icons overview.....	115
Application overview.....	116
Important information.....	118
Important information leaflet.....	118
Limitations to services and features.....	118
Legal information.....	118

Xperia™ T User guide



Getting started

About this User guide

This is the Xperia™ T User guide for the Android™ 4.3 (Jelly Bean) software version. If you're not sure which software version your device is running, you can check it via the Settings menu. For more information about software updates, see *Updating your device*.



To check the current software version of your device

- 1 From your Home screen, tap .
- 2 Find and tap **Settings** > **About phone** > **Android version**.

Android™ – what and why?

Your Xperia™ from Sony runs on the Android™ platform. Android™ devices can perform many of the same functions as a computer and you can customise them to your own needs. For example, you can add and delete applications, or enhance existing applications to improve functionality. On Google Play™ you can download a range of applications and games from a constantly growing collection. You can also integrate applications on your Android™ device with other applications and with online services that you use. For example, you can back up your contacts, access your different email accounts and calendars from one place, keep track of your appointments, and engage in social networking.

Android™ devices are constantly evolving. When a new software version is available and your device supports this new software, you can update your device to get new features and the latest improvements.

-  Your Android™ device is pre-loaded with Google™ services. To get the most out of the provided Google™ services, you should have a Google™ account and sign in to it when you first start your device. You also need to have Internet access to use many of the features in Android™.
-  New software releases may not be compatible with all devices.

Phone overview

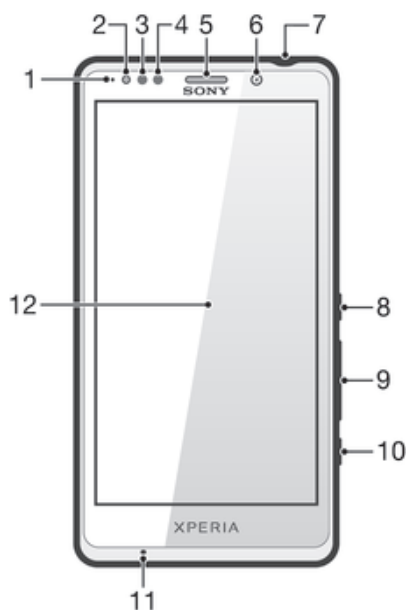

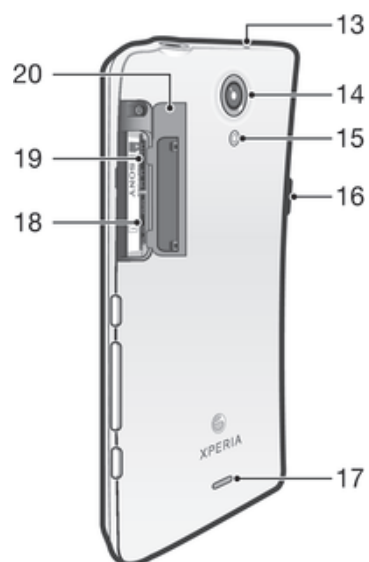

- | | |
|-----------------------|-------------------------------------|
| 1. Notification LED | 11. Main microphone |
| 2. Light sensor | 12. Touchscreen |
| 3. Proximity sensor 1 | 13. Second microphone |
| 4. Proximity sensor 2 | 14. Camera lens |
| 5. Ear speaker | 15. Camera LED light |
| 6. Front camera lens | 16. Connector for charger/USB cable |
| 7. Headset connector | 17. Speaker |
| 8. Power key | 18. SIM card slot |
| 9. Volume/Zoom key | 19. microSD™ card slot |
| 10. Camera key | 20. SIM card/microSD™ card cover |

Assembly

To insert the memory card and the micro SIM card

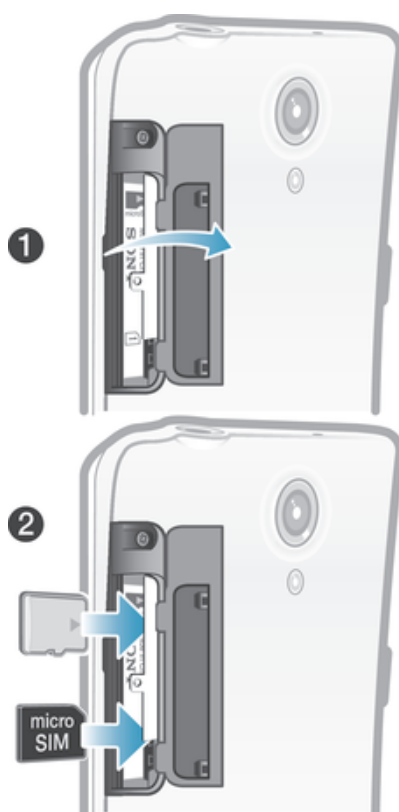

- 1 Remove the cover for the memory card and the micro SIM card.
- 2 Insert the memory card and the micro SIM card into the relevant slots.





- ! The memory card may not be included at purchase in all markets.
- ! Your phone requires a micro SIM card. Inserting an incompatible SIM card in the micro SIM card slot could damage the card or your phone, and Sony does not warrant and will not be responsible for any damage caused by use of incompatible or modified SIM cards.

Turning the device on and off



To turn on the device

- ! Make sure that the battery is charged for at least 30 minutes before you turn on the device for the first time.





- 1 Press and hold down the power key  until the device vibrates.
 - 2 If your screen goes dark, briefly press the power key  to activate the screen.
 - 3 Enter your SIM card PIN when requested, then tap .
 - 4 If your screen is locked, place a finger on the screen and swipe up or down to unlock it.
 - 5 Wait a while for the device to start.
-  Your SIM card PIN is initially supplied by your network operator, but you can change it later from the Settings menu. To correct a mistake made while entering your SIM card PIN, tap .

To turn off the device

- 1 Press and hold down the power key  until the options menu opens.
 - 2 In the options menu, tap **Power off**.
 - 3 Tap **OK**.
-  It may take a while for the device to shut down.

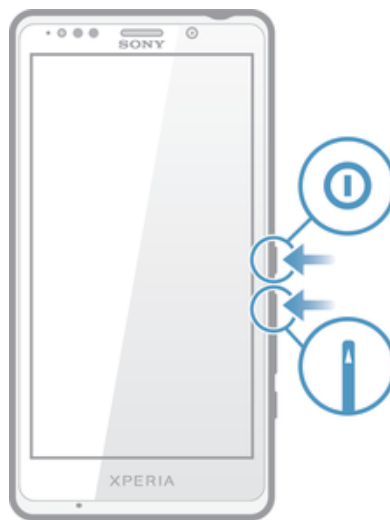
To force the device to restart



- 1 Press and hold down both the volume up key and the power key  for five seconds.
- 2 After your device vibrates once, release the keys. The device restarts automatically.

Locking and unlocking the screen

When your device is on and left idle for a set period of time, the screen darkens to save battery power, and locks automatically. This lock prevents unwanted actions on the touch screen when you are not using it.



To activate the screen

- Briefly press the power key .

To unlock the screen

- Place a finger on the screen and swipe up or down.
- 💡 There are several ways to unlock the screen. For more information, see *Setting a screen lock* on page 112.

To lock the screen

- When the screen is active, briefly press the power key .

Setup guide

The first time you start your device, a setup guide opens to help you configure basic settings, sign in to some accounts, and personalise your device. For example, if you have a Sony Entertainment Network account, you can sign in to it and start enjoying music, videos and games from the Sony Entertainment Network on your device. Or you can create a new account directly on your device.

- 💡 You can also access the setup guide later from the Settings menu.
- ! Sony Entertainment Network with Video Unlimited and Music Unlimited is not available in every market. Separate subscription required. Additional terms and conditions apply.

To access the setup guide manually

- 1 From the Home screen, tap .
- 2 Tap **Settings** > **Setup guide**.

Accounts and services

Sign in to your online service accounts from your device to get easy access when you're on the move. For example, you can integrate contacts from your Google™ account into your Contacts, so you have everything in one place. You can sign up to new online services from your device as well as from a computer.

Google™ account

Having a Google™ account is key to using a range of applications and services with your Android™ device. You need a Google™ account, for example, to use the Gmail™ application in your device, to chat with friends using Hangouts™, and to synchronise the calendar application on your device with your Google Calendar™. You also need a Google™ account to download applications and games, music, movies and books from Google Play™.

Microsoft® Exchange ActiveSync® account

Synchronise your device with your corporate Microsoft® Exchange ActiveSync® account. This way, you keep your work email, contacts and calendar events with you at all times.



Facebook™ account

Facebook™ is a social networking service that connects you with friends, family and colleagues around the world. Set up Facebook to work on your device so that you can stay in touch from anywhere.

Getting to know your device

Using the keys



-  **Back**
 - Go back to the previous screen
 - Close the on-screen keypad, a dialog box, an options menu, the Notification panel, or an application
-  **Home**
 - Go to the Home screen
-  **Task**
 - Tap to open a window showing your most recently used applications and a small apps bar

Using the touchscreen

To open or highlight an item

- Tap the item.

Marking options

- Marked checkbox
- Unmarked checkbox
- Switched on
- Switched off

To mark or unmark options

- Tap the relevant checkbox or the switch beside the option name.

Zooming

The zoom options available depend on the application you are using.

To zoom

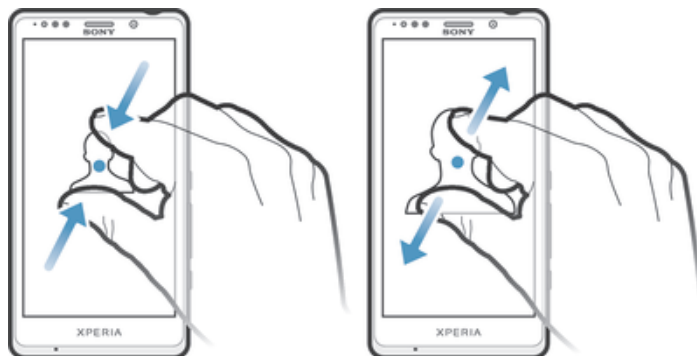

- Place two fingers on the screen at once and pinch them together (to zoom out) or spread them apart (to zoom in).
- 💡 When you use two fingers on the screen to zoom, it is only possible to zoom if both fingers are within the zoomable area. If you, for example, want to zoom in on a photo, make sure that both fingers are within the photo frame area.

Scrolling

Scroll by moving your finger up or down on the screen. On some web pages you can also scroll to the sides.

- ! Dragging or flicking will not activate anything on the screen.

To scroll

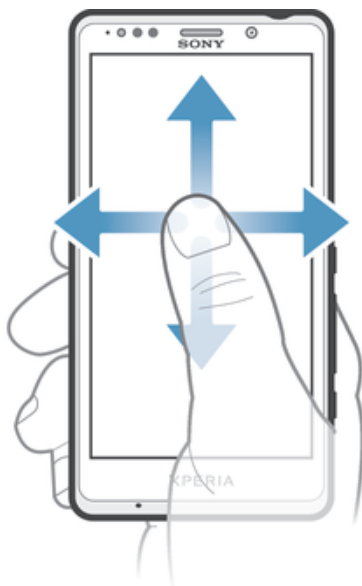

- Drag or flick your finger in the direction you want to scroll on the screen.
- 💡 To scroll more quickly, flick your finger in the direction you want to go on the screen.

To flick

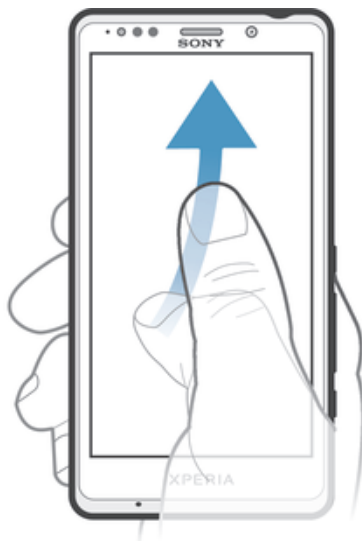

- To scroll more quickly, flick your finger in the direction you want to go on the screen. You can wait for the scrolling movement to stop by itself, or you can stop it immediately by tapping the screen.

Sensors

Your device has sensors that detect both light and proximity. The light sensor detects the ambient light level and adjusts the brightness of the screen accordingly. The proximity sensor turns the touch screen off during voice calls when your ear is close to the screen. This prevents you from unintentionally activating other functions on your device when you are engaged in a call.

Battery

Your device has an embedded battery.

Charging the battery

Your battery is partly charged when you buy your device. It may take a few minutes before the battery icon  appears on the screen when you connect the charger cable to a power source, such as a USB port or a charger. You can still use your device while it is charging. Charging your device over a long period of time, for example, overnight, does not damage the battery or the device.

To charge your device

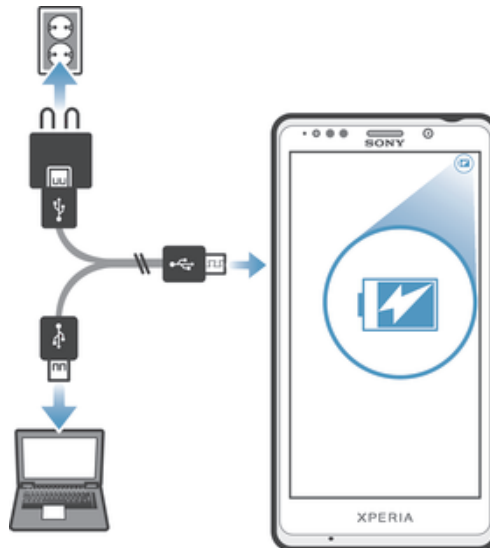

- 1 Plug the charger into a power outlet.
- 2 Plug one end of the USB cable into the charger (or into the USB port of a computer).
- 3 Plug the other end of the cable into the micro USB port on your device, with the USB symbol facing up. The notification light illuminates when charging begins.
- 4 When the device is fully charged, disconnect the cable from your device by pulling it straight outwards. Make sure not to bend the connector.

💡 Use the charger and USB cable provided with the device to ensure faster charging. If the battery is completely discharged, it may take a few minutes before the notification light illuminates and the charging icon  appears.

Battery notification light status

Green	The battery charge level is greater than 90%
Flashing red	The battery level is low
Orange	The battery is charging and the battery charge level is less than 90%

To check the battery level

- 1 From your Home screen, tap .
- 2 Find and tap **Settings** > **About phone** > **Status** > **Battery level**.

Improving battery performance

The following tips can help you improve battery performance:

- Charge your device often. This will not affect the lifetime of the battery.
- Downloading data from the Internet is power consuming. When you're not using the Internet, you can save power by disabling all data connections over mobile networks. This setting does not prevent your device from transmitting data over other wireless networks.
- Turn off Bluetooth® and Wi-Fi® connections when you don't need these features. You can turn them on and off more easily from the Notification panel by dragging down the status bar.
- Use the **STAMINA mode** and **Low battery mode** features to reduce battery consumption. You can select the power saving mode that best suits the way you use your device. You can also customise the settings of each power saving mode.
- Set your synchronisation applications (used to synchronise your email, calendar and contacts) to synchronise manually. You can also synchronise automatically, but increase the synchronisation intervals.

- Check the battery usage menu in your device to see which applications use the most power. Your battery consumes more power when you use video and music streaming applications, such as YouTube™. Some applications downloaded from Google Play™ may also consume more power.
- Close and exit applications that you are not using.
- Lower the screen display brightness level.
- Turn off your device or activate the **Airplane mode** setting if you are in an area with no network coverage. Otherwise, your device repeatedly scans for available networks, and this consumes power.
- Use a Sony™ original handsfree device to listen to music. Handsfree devices demand less battery power than your device's own loudspeakers.
- Keep your device in standby whenever possible. Standby time refers to the time during which your device is connected to the network and is not being used.
- Disable any live wallpaper.



To access the battery usage menu

- 1 From your Home screen, tap .
- 2 Find and tap **Settings** > **Power management** > **Battery usage**.



Using STAMINA mode

Activate the **STAMINA mode** feature to pause your Wi-Fi® connection, data traffic and several power consuming applications when your screen is inactive. When STAMINA mode is active, you can still receive phone calls, and text and multimedia messages. You can also set up an applications list to allow some applications to keep running when your screen is inactive. Once the screen becomes active again, all paused functions are resumed.

To activate STAMINA mode

- 1 Drag the status bar downwards, then tap .
- 2 Find and tap **Power management**.
- 3 Drag the slider beside **STAMINA mode** to the right, then tap **Activate**.  appears in the status bar when STAMINA mode is activated.

To deactivate STAMINA mode

- 1 From your Home screen, tap .
- 2 Find and tap **Settings** > **Power management**.
- 3 Tap  next to **STAMINA mode**.

To change the settings for STAMINA mode

- 1 From your Home screen, tap .
- 2 Find and tap **Settings** > **Power management**.
- 3 To open the settings menu, tap **STAMINA mode**.
- 4 Add or remove applications, as desired.
- 5 When you're finished, tap **Done**.

Estimating the standby time of your device

Standby time refers to the amount of time the battery can last when your device is connected to the network but is not in active use, for example, to receive or make phone calls. STAMINA mode, when activated, continuously evaluates the remaining standby time, which can vary depending on how you use your device. STAMINA mode is more effective in lengthening the standby time if you keep the screen of your device locked. If you rarely lock the screen, you may not see much improvement in battery performance.

- ! When you use your device for the first time, the estimated standby time may not be accurate since there is no previous usage history to estimate from.



To view the estimated standby time

- 1 From your Home screen, tap .
- 2 Find and tap **Settings** > **Power management**.



Using Low battery mode

You can activate the **Low battery mode** feature to save power when the battery level is low. This feature helps you to adjust the settings for screen brightness, data traffic and the vibrate function so that you can reduce battery consumption.



To activate Low battery mode

- 1 From your Home screen, tap .
- 2 Find and tap **Settings > Power management**.
- 3 Tap  next to **Low battery mode**, then tap **Activate**.

To deactivate Low battery mode

- 1 From your Home screen, tap .
- 2 Find and tap **Settings > Power management**.
- 3 Tap  next to **Low battery mode**.

To change the settings for Low battery mode



- 1 From your Home screen, tap .
- 2 Find and tap **Settings > Power management**.
- 3 To open the settings menu, tap **Low battery mode**.
- 4 Adjust the settings as desired.
- 5 When you're finished, tap .

Lock screen



The lock screen is the screen that you see when the device is locked but the screen is active. The lock screen can have up to five panes and you can add one widget to each pane. You can then access these widgets from the lock screen. For example, you can add the Calendar widget and an email widget so that you can gain quicker access to these applications.

- ! The Clock widget is located by default in the middle pane of the lock screen.

To add a widget to the lock screen

- 1 To activate the screen, briefly press the power key .
- 2 Swipe inwards from the top left area of the screen until  appears, then tap it.
- 3 If required, enter your PIN code, pattern or password to unlock the screen.
- 4 Find and tap the widget that you want to add.
- 5 Follow the on-screen instructions, if necessary, to finish adding the widget.

To remove a widget from the lock screen

- 1 To activate the screen, briefly press the power key .
- 2 Touch and hold the widget that you want to remove, then drag it to .

To move a widget on the lock screen

- 1 To activate the screen, briefly press the power key .
- 2 Touch and hold the widget that you want to move, then drag it to the new location.

Home screen

The Home screen is the starting point for using your device. You can customise it with applications, widgets, shortcuts, folders, themes, and wallpaper. You can also add extra panes.

The Home screen extends beyond the regular screen display width, so you need to flick left or right to view content in all of the Home screen's panes.

 shows which part of the Home screen you are in. You can set a pane as the main Home screen pane, and add or delete panes.



To go to the Home screen

- Press .

To browse the Home screen

- Flick right or left.

To set a pane as the main Home screen pane

- 1 Touch and hold an empty area on your Home screen until the device vibrates.
- 2 Flick left or right to browse to the pane that you want to set as your main Home screen pane, then tap .

To add a pane to your Home screen

- 1 Touch and hold an empty area on your Home screen until the device vibrates.
- 2 Flick left or right to browse the panes, then tap .

To delete a pane from your Home screen

- 1 Touch and hold an empty area on your Home screen until the device vibrates.
- 2 Flick left or right to browse to the pane that you want to delete, then tap .

Widgets

Widgets are small applications that you can use directly on your Home screen. For example, the “WALKMAN” widget allows you to start playing music directly.

Some widgets are resizable, so you can expand them to view more content or shrink them to save space on your Home screen.

To add a widget to the Home screen

- 1 Touch and hold an empty area on your Home screen until the device vibrates, then tap **Widgets**.
- 2 Find and tap the widget that you want to add.

To resize a widget





- 1 Touch and hold a widget until it magnifies and the device vibrates, then release the widget. If the widget can be resized, for example, the Calendar widget, then a highlighted frame and resizing dots appear.
- 2 Drag the dots inward or outward to shrink or expand the widget.
- 3 To confirm the new size of the widget, tap anywhere on the Home screen.

Rearranging your Home screen

Customise the appearance of your Home screen and change the features that you can access from it. Change the screen background, move items around, create folders, and add shortcuts and widgets.

Customisation options

When you touch and hold an empty area of your Home screen, the following customisation options appear:

-  Add widgets to your Home screen.
-  Add applications and shortcuts.
-  Set a wallpaper for your Home screen.
-  Set a background theme.

To view customisation options from the Home screen

- Touch and hold an empty area on your Home screen until the device vibrates and customisation options appear at the bottom of the screen.

To add a shortcut to your Home screen

- 1 Touch and hold an empty area on your Home screen until the device vibrates and the customisation menu appears.
 - 2 In the customisation menu, tap **Apps**.
 - 3 Scroll through the list of applications and select an application. The selected application gets added to the Home screen.
-  In step 3, alternatively, you can tap **Shortcuts** and then select an application from the list available. If you use this method to add shortcuts, some of the applications available allow you to add specific functionality to the shortcut.

To move an item on the Home screen

- Touch and hold the item until it magnifies and the device vibrates, then drag the item to the new location.

To delete an item from the Home screen

- Touch and hold an item until it magnifies and the device vibrates, then drag the item to .

To create a folder on the Home screen

- Touch and hold an application icon or a shortcut until it magnifies and the device vibrates, then drag and drop it on top of another application icon or shortcut.

To add items to a folder on the Home screen

- Touch and hold an item until it magnifies and the device vibrates, then drag the item to the folder.

To rename a folder on the Home screen

- 1 Tap the folder to open it.
- 2 Tap the folder's title bar to show the **Folder name** field.
- 3 Enter the new folder name and tap **Done**.

Changing the background of your Home screen

Adapt the Home screen to your own style using wallpapers and different themes.

To change your Home screen wallpaper

- 1 Touch and hold an empty area on your Home screen until the device vibrates.
- 2 Tap **Wallpapers** and select an option.

To set a theme for your Home screen

- 1 Touch and hold an empty area on your Home screen until the device vibrates.
- 2 Tap **Themes**, then select a theme.

! When you change a theme, the background also changes in some applications.

Taking a screenshot

You can capture still images of any screen on your device as a screenshot. Screenshots you take are automatically saved in Album.

To take a screenshot

- 1 Press and hold down the power key and the volume down key simultaneously until you hear a clicking sound.
- 2 To view the screenshot, drag the status bar fully downwards.

Accessing and using applications

Open applications from shortcuts on your Home screen or from the Application screen.

Application screen

The Application screen, which you open from your Home screen, contains the applications that come pre-installed on your device as well as the applications you download.

The Application screen extends beyond the regular screen width, so you need to flick left and right to view all content.

To open the Application screen



- From your Home screen, tap .

To browse the Application screen

- From the Application screen, flick right or left.

To open the Application screen menu

- When the Application screen is open, drag the left edge of the screen to the right.

To add an application shortcut to the Home screen



- 1 From the Application screen, touch and hold an application icon until the screen vibrates, then drag the icon to the top of the screen. The Home screen opens.
- 2 Drag the icon to the desired location on the Home screen, then release your finger.

Opening and closing applications

To open an application

- From your Home screen or the Application screen, tap the application.

To close an application

- Press .
- 💡 Some applications are paused when you press  to exit, while other applications may continue to run in the background. In the first case, the next time you open the application, you can continue where you left off. Remember that some applications may cause data connection charges when they are running in the background, for example, social networking services.

Recently used applications window

You can switch between recently used applications from this window. You can also open small apps.

To open the recently used applications window

- Press .

Using small apps

From the recently used applications window, you can get quick access to several small apps at any time using the small apps bar. A small app only takes up a small area of your screen. So you can interact with a small app and another application at the same time on the same screen.

To open the small apps bar

- Press .

To open a small app

- 1 To make the small apps bar appear, press .
- 2 Tap the small app that you want to open.

- 💡 You can open several small apps at the same time.

To close a small app

- Tap  on the small app window.

To move a small app

- When the small app is open, touch and hold the top left corner of the small app, then move it to the desired location.

To minimise a small app

- When the small app is open, touch and hold the top left corner of the small app, then drag it to the right edge or to the bottom edge of the screen.

To rearrange the small apps in the small apps bar

- Touch and hold a small app and drag it to the desired position.



To remove a small app from the small apps bar

- Touch and hold a small app, then drag it to .





To restore a previously removed small app

- 1 Open the small apps bar, then tap .
- 2 Touch and hold the small app that you want to restore, then drag it into the small apps bar.

To download a small app

- 1 From the small apps bar, tap , then tap  and tap .
- 2 Search for the small app that you want to download, then follow the instructions to download it and complete the installation.

To add a widget as a small app

- 1 To make the small apps bar appear, press .
- 2 Tap  >  > .
- 3 Select a widget.
- 4 Enter a name for the widget, if desired, then tap **OK**.

Application menu

You can open a menu at any time when you are using an application. The menu will look different depending on which application you are using.

To open a menu in an application

- While using the application, press .
- ! A menu is not available in all applications.

Rearranging your Application screen

Move the applications around on the Application screen according to your preferences.

To arrange applications on the Application screen

- 1 To open the Application screen menu, drag the left edge of the Application screen to the right.
- 2 Select the desired option under **SHOW APPS**.

To move an application on the Application screen

- 1 To open the Application screen menu, drag the left edge of the Application screen to the right.
- 2 Make sure that **Own order** is selected under **SHOW APPS**.
- 3 Touch and hold the application until it magnifies and the device vibrates, then drag it to the new location.

To uninstall an application from the Application screen

- 1 To open the Application screen menu, drag the left edge of the Application screen to the right.
- 2 Tap **Uninstall**. All uninstalleable applications are indicated by .
- 3 Tap the application that you want to uninstall, then tap **Uninstall**.

Status and notifications

The status bar at the top of your screen shows what's going on in your device. To the left you get notifications when there is something new or ongoing. For example, new message and calendar notifications appear here. The right side shows the signal strength, battery status, and other information.



The status bar allows you to adjust basic settings on your device, for example, Wi-Fi®, Bluetooth™, data traffic, and sound. You can also open the settings menu from the Notification panel to change other settings.

A notification light also gives you battery status information and some notifications. For example, a flashing blue light means there is a new message or a missed call. The notification light may not work when the battery level is low.



Checking notifications and ongoing activities

You can drag down the status bar to open the Notification panel and get more information. For example, you can use the panel to open a new message or view a calendar event. You can also open some applications that run in the background, such as the music player.

To open the Notification panel



- Drag the status bar downwards.

To close the Notification panel



- Drag the tab at the bottom of the Notification panel upwards.

To take action on a notification

- Tap the notification.

To dismiss a notification from the Notification panel

- Place your finger on a notification and flick left or right.

To clear all notifications from the Notification panel

- Tap **Clear**.

Setting your device from the Notification panel

You can open the settings menu from the Notification panel to adjust device quick settings. For example, you can turn on Wi-Fi®.

To open the device settings menu from the Notification panel

- 1 Drag the status bar downwards.
- 2 Tap .

To adjust sound settings from the Notification panel

- 1 Drag the status bar downwards.
- 2 Tap .

To control the Bluetooth® function from the Notification panel

- 1 Drag the status bar downwards.
- 2 Tap .

To control the Wi-Fi® function from the Notification panel

- 1 Drag the status bar downwards.
- 2 Tap .

To adjust brightness level from the Notification panel

- 1 Drag the status bar downwards.
- 2 Tap .



Customising quick settings from the Notification panel

You can customise quick settings from the Notification panel by selecting the quick settings you want, and rearranging their order. You can select up to 10 quick settings, or you can also select none of them.

To select quick settings from the Notification panel

- 1 Drag the status bar downwards, then tap .
- 2 Find and tap **Display > Quick settings**.
- 3 Select the quick settings you want.

To rearrange the quick settings from the Notification panel

- 1 Drag the status bar downwards, then tap .
- 2 Find and tap **Display > Quick settings**.
- 3 Touch and hold  beside a quick setting, then move it to the desired position.

Accessing settings

View and change settings for your device from the Settings menu. The Settings menu is accessible from both the Notification panel and the Application screen.

To access your device settings

- 1 From your Home screen, tap .
- 2 Tap **Settings**.



- You can also drag the status bar downwards on the Home screen and tap  to access your device settings.

On-screen keyboard

You can enter text with the on-screen QWERTY keyboard by tapping each letter individually, or you can use the Gesture input feature and slide your finger from letter to letter to form words.

You can select up to three languages for text input. The keyboard detects the language that you are using and predicts the words for that language as you type. Some applications open the on-screen keyboard automatically, for example, email and text messaging applications.



- 1 Delete a character before the cursor.
- 2 Enter a carriage return or confirm text input.
- 3 Enter a space.
- 4 Personalise your keyboard. This key disappears after the keyboard is personalised.
- 5 Display numbers and symbols. For even more symbols, tap +=.\$.
- 6 Switch between lower-case , upper-case  and caps . For some languages, this key is used to access extra characters in the language.

To display the on-screen keyboard to enter text

- Tap a text entry field.

To use the on-screen keyboard in landscape orientation

- When the on-screen keyboard is displayed, turn the device sideways.
- ! You may need to adjust the settings in some applications to enable landscape orientation.

To enter text character by character

- 1 To enter a character visible on the keyboard, tap the character.
- 2 To enter a character variant, touch and hold a regular keyboard character to get a list of available options, then select from the list. For example, to enter "é", touch and hold "e" until other options appear, then, while keeping your finger pressed on the keyboard, drag to and select "é".



To enter a period

- After you enter a word, double-tap the space bar.

To enter text using the Gesture input function

- 1 When the on-screen keyboard is displayed, slide your finger from letter to letter to trace the word that you want to write.
- 2 After you finish entering a word, lift up your finger. A word suggestion appears based on the letters that you have traced.
- 3 If the word that you want does not appear, tap  to see other options and select accordingly. If the desired option does not appear, delete the entire word and trace it again, or enter the word by tapping each letter individually.

To change the Gesture input settings

- 1 When the on-screen keyboard is displayed, tap .
- 2 Tap , then tap **Keyboard settings** > **Text input settings**.
- 3 To activate or deactivate the Gesture input function, mark or unmark the **Gesture input** checkbox.

Phonepad

The Phonepad is similar to a standard 12-key telephone keypad. It gives you predictive text and multi-tap input options. You can activate the Phonepad text input method via the keyboard settings. The Phonepad is only available in portrait orientation.





- 1 Choose a text input option. You can tap each character once and use word suggestions, or keep tapping the key until the desired character is selected.
- 2 Delete a character before the cursor.
- 3 Enter a carriage return or confirm text input.
- 4 Enter a space.
- 5 Display symbols and smileys.
- 6 Display numbers.
- 7 Change the character case and turn on the caps lock.

To open the Phonepad for the first time

- 1 Tap a text entry field, then tap 12!?.
- 2 Tap , then tap **Keyboard settings**.
- 3 Tap **Keyboard appearance > Keyboard layout**.
- 4 Select the Phonepad.

To enter text using the Phonepad

- When  appears in the Phonepad, tap each character key only once, even if the letter you want is not the first letter on the key. Tap the word that appears or tap  to view more word suggestions and select a word from the list.
- When  appears in the Phonepad, tap the on-screen key for the character you want to enter. Keep tapping this button until the desired character is selected. Then do the same for the next character you want to enter, and so on.

To enter numbers using the Phonepad

- When the Phonepad is displayed, tap 123. A Phonepad with numbers appears.





To insert symbols and smileys using the Phonepad

- 1 When the Phonepad is displayed, tap &☺. A grid with symbols and smileys appears.
- 2 Scroll up or down to view more options. Tap a symbol or smiley to select it.



Entering text using voice input

When you enter text, you can use the voice input function instead of typing the words. Just speak the words that you want to enter. Voice input is an experimental technology from Google™, and is available for a number of languages and regions.

To enable voice input

- 1 When you enter text using the on-screen keyboard or the Phonepad, tap  or .
- 2 Tap , then tap **Keyboard settings**.
- 3 Mark the **Google voice typing key** checkbox.
- 4 Press  to save your settings. A microphone icon  appears on your on-screen keyboard or Phonepad.

To enter text using voice input

- 1 Open the on-screen keyboard or the Phonepad.
- 2 Tap . When  appears, speak to enter text. When you're finished, tap  again. The suggested text appears.
- 3 Edit the text manually if necessary.

Editing text

You can select, cut, copy and paste text as you write in both portrait and landscape orientation by double tapping the entered text. In portrait orientation, the necessary editing tools are available via an application bar. In landscape orientation, an Edit button provides the same tools.

Application bar



- 1 Close the application bar
- 2 Select all text
- 3 Cut text
- 4 Copy text
- 5 Paste text

!  only appears when you have text saved on the clipboard.

To select text

- 1 Enter some text, then double-tap the text. The word you tap gets highlighted by tabs on both sides.
- 2 Drag the tabs left or right to select more text.

To edit text in portrait orientation

- 1 Enter some text, then double-tap the entered text to make the application bar appear.
- 2 Select the text you want to edit, then use the application bar to make your desired changes.

To edit text in landscape orientation

- 1 Enter some text, then double-tap the entered text.
- 2 Select the text you want to work with, then tap **Edit...** and select an option.

Personalising the Xperia keyboard

When entering text using the on-screen keyboard or the Phonepad, you can access a keyboard settings and other text input settings that help you set options for writing languages, text prediction, automatic spacing and quick full stops. For example, you can decide how word options are presented and how words get corrected as you

type. And you can get your message data scanned so that word predictions fit your writing style. You can also set the text input application to remember new words that you write.

To access the on-screen keyboard and Phonepad settings

- 1 When you enter text using the on-screen keyboard or Phonepad, tap ^{12!?} or ¹²³.
- 2 Tap , then tap **Keyboard settings**, and change the settings as you desired.
- 3 To add a writing language for text input, tap **Writing languages** and mark the relevant checkboxes.
- 4 Tap **OK** to confirm.

To change the text input settings

- 1 When you enter text using the on-screen keyboard or the Phonepad, tap ^{12!?} or ¹²³.
- 2 Tap , then tap **Keyboard settings** > **Text input settings** and select the relevant settings.



To display the Smiley key

- 1 When you enter text using the on-screen keyboard, tap ^{12!?}.
- 2 Tap , then tap **Keyboard settings** > **Keyboard appearance** > **Additional keys**.
- 3 Mark the **Smiley key** checkbox.

To use your writing style

- 1 When you enter text using the on-screen keyboard or Phonepad, tap ^{12!?} or ¹²³.
- 2 Tap , then tap **Keyboard settings** > **Use my writing style** and select a source.

To select a keyboard layout variant

-  Layout variants are only available for the on-screen keyboard when you select two or three writing languages and may not be available in all writing languages.
- 1 When you enter text using the on-screen keyboard, tap ^{12!?}.
 - 2 Tap , then tap **Keyboard settings**.
 - 3 Tap **Writing languages**, then tap .
 - 4 Select a keyboard layout variant.
 - 5 Tap **OK** to confirm.

Customising your device

You can adjust several device settings to suit your own needs. For example, you can change the language, add a personal ringtone, or change the screen brightness.

Adjusting the volume

You can adjust the ringtone volume for incoming calls and notifications as well as for music and video playback.

To adjust the ringtone volume with the volume key

- Press the volume key up or down.

To adjust the media playing volume with the volume key

- When playing music or watching video, press the volume key up or down.



Adjusting the sound settings

You can adjust several sound settings. For example, you can set your device to silent mode so that it doesn't ring when you're in a meeting.

To set your device to vibrate mode

- Press the volume key down until  appears in the status bar.

To set your device to silent mode

- 1 Press the volume key down until the device vibrates and  appears in the status bar.
- 2 Press the volume key down again.  appears in the status bar.

To set your device to vibrate and ring mode

- 1 From your Home screen, tap .
- 2 Find and tap **Settings > Sound**.
- 3 Mark the **Vibrate when ringing** checkbox.

Date and time

You can change the date and time on your device.

To set the date manually

- 1 From the Home screen, tap .
- 2 Find and tap **Settings > Date & time**.
- 3 Unmark the **Automatic date & time** checkbox, if it is marked.
- 4 Tap **Set date**.
- 5 Adjust the date by scrolling up and down.
- 6 Tap **Set**.

To set the time manually

- 1 From your Home screen, tap .
- 2 Find and tap **Settings > Date & time**.
- 3 Unmark the **Automatic date & time** checkbox if it is marked.
- 4 Tap **Set time**.
- 5 Scroll up or down to adjust the hour and minute.
- 6 If applicable, scroll up to change **AM** to **PM**, or vice versa.
- 7 Tap **Set**.

To set the time zone

- 1 From your Home screen, tap .
- 2 Find and tap **Settings > Date & time**.
- 3 Unmark the **Automatic time zone** checkbox, if it is marked.
- 4 Tap **Select time zone**.
- 5 Select an option.

Ringtone settings

To set a ringtone

- 1 From your Home screen, tap .
- 2 Find and tap **Settings > Sound > Phone ringtone**.
- 3 Select a ringtone.
- 4 Tap **Done**.

To enable touch tones

- 1 From your Home screen, tap .
- 2 Find and tap **Settings > Sound**.
- 3 Mark the **Dial pad touch tones** and **Touch sounds** checkboxes.

To select the notification sound

- 1 From your Home screen, tap .
- 2 Find and tap **Settings > Sound > Notification sound**.
- 3 Select the sound to be played when notifications arrive.
- 4 Tap **Done**.

Screen settings

To adjust the screen brightness

- 1 From your Home screen, tap .
- 2 Find and tap **Settings** > **Display** > **Brightness**.
- 3 Unmark the **Adapt to lighting conditions** checkbox if it is marked.
- 4 Drag the slider to adjust the brightness.

 Lowering the brightness level increases battery performance.

To set the screen to vibrate on touch

- 1 Drag the status bar downwards, then tap  > **Sound**.
- 2 Mark the **Vibrate on touch** checkbox. The screen now vibrates when you tap soft keys and certain applications.

To adjust the idle time before the screen turns off

- 1 From your Home screen, tap .
- 2 Find and tap **Settings** > **Display** > **Sleep**.
- 3 Select an option.



 To turn off the screen quickly, briefly press the power key .

Language settings

You can select a default language for your device and change it again at a later time.

To change the language

- 1 From the Home screen, tap .
- 2 Find and tap **Settings** > **Language & input** > **Language**.
- 3 Select an option.
- 4 Tap **OK**.

 If you select the wrong language and cannot read the menu texts, find and tap . Then select the text beside  and select the first entry in the menu that opens. You can then select the language you want.

Airplane mode

In Airplane mode, the network and radio transceivers are turned off to prevent disturbance to sensitive equipment. However, you can still play games, listen to music, watch videos and other content, as long as all this content is saved on your memory card or internal storage. You can also be notified by alarms, if alarms are activated.

 Turning on Airplane mode reduces battery consumption.

To turn on Airplane mode

- 1 From your Home screen, tap .
- 2 Find and tap **Settings** > **More....**
- 3 Mark the **Airplane mode** checkbox.

 You can also press and hold down the power key  and then select **Airplane mode** in the menu that opens.

Memory

You can save content to your device's internal storage and to a memory card.

To view the status of your memory

- 1 From your Home screen, tap .
- 2 Find and tap **Settings** > **Storage** to view the status of your memory.

Formatting the internal storage

You can format your phone's internal storage, for example, to free up memory. By doing so, you erase all data on the internal storage.

Make sure you make backups of everything that you want to save before formatting the internal storage. To back up your content, you can copy it to a computer. For more information, refer to *Connecting your device to a computer* on page 94

To format the internal storage

- 1 From your Home screen, tap .
- 2 Find and tap **Settings > Storage > Clear internal storage**.
- 3 Tap **Clear internal storage > Erase everything**.

Memory card

Your device supports a microSD™ memory card, which is used for storing content. This type of card can also be used as a portable memory card with other compatible devices.

- ! You may have to purchase a memory card separately.

Safely removing the memory card

You can safely remove the memory card from your device any time when the device is turned off. If you want to remove the memory card when your device is on, you must first unmount the memory card before you physically remove it from the device. This can prevent damaging the memory card or losing data stored on the memory card.

To unmount the memory card

- 1 Drag the status bar downwards, then tap .
- 2 Find and tap **Storage > Unmount SD card**.

Formatting the memory card

You can format the memory card in your device, for example, to free up memory. This means that you erase all data on the card.

- ! All content on the memory card gets erased when you format it. Make sure you make backups of everything you want to save before formatting the memory card. To back up your content, you can copy it to your computer. For more information, refer to the chapter *Connecting your device to a computer* on page 94.

To format the memory card

- 1 Drag the status bar downwards, then tap .
- 2 Find and tap **Storage > Erase SD card**.
- 3 To confirm, tap **Erase SD card > Erase everything**

Clearing the application memory

You may sometimes need to clear the memory for an application. This might happen if, for example, the application memory becomes full, or you want to clear scores for a game. You might also want to delete incoming email, text and multimedia messages in some applications.

To clear the memory for an application

- 1 Drag the status bar downwards, then tap .
- 2 Find and tap **Apps**.
- 3 Tap the application for which you want to clear the memory.
- 4 Tap **Clear cache**.

- ! It is not possible to clear the memory for some applications.

Using a headset



- ! Use the accessories provided with your device, or other compatible accessories, for optimal performance.

To use a headset

- 1 Connect the headset to your device.
 - 2 To answer a call, press the call handling key.
 - 3 To end the call, press the call handling key.
- ! If a headset is not included with the device, you may purchase one separately.
 - 💡 If you are listening to music, the music stops when you answer a call and resumes after you end the call.

Internet and messaging settings

To access the Internet and to send multimedia messages, you must have a mobile data connection and the correct settings, also known as APN (Access Point Name) settings. The APN identifies the network that a mobile device can connect to.



You can usually download Internet and messaging settings when you set up your device for the first time with a SIM card inserted. In other cases, the settings may be pre-installed. If not, you can download or add the settings manually. Contact your network operator for detailed information about Internet and messaging settings.

- 💡 If you cannot access the Internet, have no data connection, or cannot send or receive multimedia messages, try deleting all Internet and messaging settings and then add them again.

To download Internet and messaging settings

- 1 From your Home screen, tap .
- 2 Find and tap **Settings** > **Xperia™** > **Internet settings**.
- 3 Tap **Accept**.

To reset the default Internet settings

- 1 Drag the status bar downwards, then tap .
- 2 Tap **More...** > **Mobile networks**.
- 3 Tap **Access Point Names**, then tap .
- 4 Tap **Reset to default**.

Access Point Names (APNs)



An APN is used to establish data connections between your device and the Internet. The APN defines which type of IP address to use, which security methods to invoke, and which fixed-end connections to use. Checking the APN is useful when you cannot access the Internet, have no data connection, or cannot send or receive multimedia messages.

To view the current APN

- 1 From your Home screen, tap .
- 2 Find and tap **Settings** > **More...** > **Mobile networks**.
- 3 Tap **Access Point Names**.

- ! If you have several available connections, the active network connection is indicated by a marked button.

To add Internet settings manually

- 1 From your Home screen, tap .
- 2 Find and tap **Settings** > **More...** > **Mobile networks**.
- 3 Tap **Access Point Names** > **+**.
- 4 Tap **Name** and enter the name of the network profile that you want to create.
- 5 Tap **APN** and enter the access point name.
- 6 Enter all other information required by your network operator.
- 7 When you're done, tap , then tap **Save**.

Usage info

For quality purposes, Sony Mobile collects anonymous bug reports and statistics regarding your device. None of the information gathered includes personal data.

To allow the sending of usage info

- 1 From your Home screen, tap .
- 2 Find and tap **Settings** > **Xperia™** > **Usage info settings**.
- 3 Mark the **Send usage info** checkbox if it is not already marked.
- 4 Tap **OK**.

Controlling data usage

You can keep track of the amount of data transferred to and from your device over your mobile data or Wi-Fi® connection during a given period. For example, you can view the amount of data used by individual applications. For data transferred over your mobile data connection, you can also set data usage warnings and limits to avoid additional charges.

- ! Adjusting data usage settings can help you keep greater control over data usage but cannot guarantee the prevention of additional charges.

To turn data traffic on or off

- 1 Drag the status bar downwards, then tap .
- 2 Tap **Data usage**.
- 3 Drag the slider beside **Mobile data** to turn data traffic on or off.

- 💡 When data traffic is turned off, your device can still establish Wi-Fi® and Bluetooth® connections.

To set a data usage warning

- 1 Make sure that data traffic is turned on.
- 2 Drag the status bar downwards, then tap .
- 3 Find and tap **Data usage**.
- 4 To set the warning level, drag the warning line to the desired value. You receive a warning notification when the amount of data traffic approaches the level you set.

To set a data usage limit

- 1 Make sure that data traffic is turned on.
 - 2 Drag the status bar downwards, then tap ✕.
 - 3 Find and tap **Data usage**.
 - 4 Mark the **Set mobile data limit** checkbox if it is not marked, then tap **OK**.
 - 5 To set the data usage limit, drag the corresponding line to the desired value.
- ! Once your data usage reaches the set limit, data traffic on your device will be turned off automatically.

To control the data usage of individual applications

- 1 Drag the status bar downwards, then tap ✕.
 - 2 Find and tap **Data usage**.
 - 3 Find and tap the desired application.
 - 4 Mark the **Restrict background data** checkbox.
 - 5 To access more specific settings for the application (if available), tap **View app settings** and make the desired changes.
- 💡 The performance of individual applications may be affected if you change the related data usage settings.

To view data transferred via Wi-Fi®

- 1 From your Home screen, tap ☰.
- 2 Find and tap **Settings** > **Data usage**.
- 3 Tap ☰, then mark the **Show Wi-Fi usage** checkbox if it is not marked.
- 4 Tap the **Wi-Fi** tab.

Mobile network settings

Your device automatically switches between mobile networks depending on what mobile networks are available in different areas. You can also manually set your device to use a particular mobile network mode, for example, WCDMA or GSM.

To select a network mode

- 1 From your Home screen, tap ☰.
- 2 Find and tap **Settings** > **More...** > **Mobile networks**.
- 3 Tap **Network Mode**.
- 4 Select a network mode.

To select another network manually

- 1 From the Home screen, tap ☰.
 - 2 Find and tap **Settings** > **More...** > **Mobile networks** > **Service providers**.
 - 3 Tap **Search mode** > **Manual**.
 - 4 Select a network.
- ! If you select a network manually, your device will not search for other networks, even if you move out of range of the manually selected network.

To activate automatic network selection

- 1 Drag the status bar downwards, then tap ✕.
- 2 Find and tap **More...** > **Mobile networks** > **Service providers**.
- 3 Tap **Search mode** > **Automatic**.

Data roaming

Some network operators allow you to send and receive mobile data when you are roaming outside of your home network. It's recommended to check the relevant data transmission rates in advance.

To activate data roaming

- 1 From the Home screen, tap .
 - 2 Find and tap **Settings** > **More...** > **Mobile networks**.
 - 3 Mark the **Data roaming** checkbox.
- ! You can't activate data roaming when data connections have been deactivated.

Downloading applications

Downloading applications from Google Play™

Google Play™ is the official online Google store for downloading applications, games, music, movies and books. It includes both free and paid applications. Before you start downloading from Google Play™, make sure that you have a working Internet connection, preferably over Wi-Fi® to limit data traffic charges.

- ! To use Google Play™, you need to have a Google™ account. Google Play™ may not be available in all countries or regions.

To download an application from Google Play™

- 1 From the Home screen, tap .
 - 2 Find and tap **Play Store**.
 - 3 Find an item you wish to download by browsing categories, or by using the search function.
 - 4 Tap the item to view its details, and follow the instructions to complete the installation.
- ! Some applications may need to access data, settings and various functions on your device in order to work properly. Only install and give permissions to applications that you trust.
 - 💡 You can view the permissions granted to a downloaded application by tapping the application under **Settings > Apps**.

Downloading applications from other sources

When your device is set to allow downloads from sources other than Google Play™, you can download applications directly from other websites by following the relevant download instructions.

- ! Installing applications of unknown or unreliable origin can damage your device. Only download applications from reliable sources. Contact the application provider if you have any questions or concerns.

To allow the download of applications from other sources

- 1 From your Home screen, tap .
 - 2 Find and tap **Settings > Security**.
 - 3 Mark the **Unknown sources** checkbox.
 - 4 Tap **OK**.
- ! Some applications may need to access data, settings and various functions on your device in order to work properly. Only install and give permissions to applications you trust.
 - 💡 You can view the permissions granted to a downloaded application by tapping the application under **Settings > Apps**.

Calling



Making calls

You can make a call by manually dialling a phone number, by tapping a number saved in your contacts list, or by tapping the phone number in your call log view. You can also use the smart dial feature to quickly find numbers from your contacts list and call logs. To make a video call, you can use the Hangouts™ instant messaging and video chat application on your device. See *Instant messaging and video chat* on page 51.



- 1 Open your contacts list
- 2 View your call log entries
- 3 View your favourite contacts
- 4 View all contact groups saved to your device
- 5 Delete number
- 6 Dialpad
- 7 Hide or clear the call log
- 8 Call button
- 9 Hide or show the dialer



To make a call by dialling

- 1 From your Home screen, tap .
- 2 Find and tap **Phone**.
- 3 Enter the number of the recipient and tap .

To make a call using smart dial

- 1 From your Home screen, tap .
- 2 Find and tap **Phone**.
- 3 Use the dialpad to enter letters or numbers that correspond to the contact you want to call. As you enter each letter or number, a list of possible matches appears.
- 4 Tap the contact you want to call.

To make an international call

- 1 From your Home screen, tap .
- 2 Find and tap **Phone**.
- 3 Touch and hold 0 until a “+” sign appears.
- 4 Enter the country code, area code (without the first 0) and phone number, then tap .

Showing or hiding your phone number

You can select to show or hide your phone number on call recipients' devices when you call them.

To show or hide your phone number

- 1 From your Home screen, tap .
- 2 Find and tap **Settings** > **Call settings** > **Additional settings** > **Caller ID**.

Receiving calls

To answer a call



To decline a call



To mute the ringtone for an incoming call

- When you receive the call, press the volume key.

Rejecting a call with a message

You can reject a call with a predefined message. When you reject a call with such a message, the message is automatically sent to the caller and saved on your device.

Six messages are predefined on your device. You can select from these predefined messages, which can also be edited if necessary.

To reject a call with a predefined message

- Drag **Reject with message** upward, then select a message.

To reject a second call with a predefined message

- When you hear repeated beeps during a call, drag **Reject with message** upward, then select a message.

To edit the message used to reject a call

- 1 From your Home screen, tap .
- 2 Find and tap **Settings** > **Call settings** > **Reject call with message**.
- 3 Tap the message you want to edit, then make the necessary changes.
- 4 When you're done, tap **OK**.

Ongoing calls

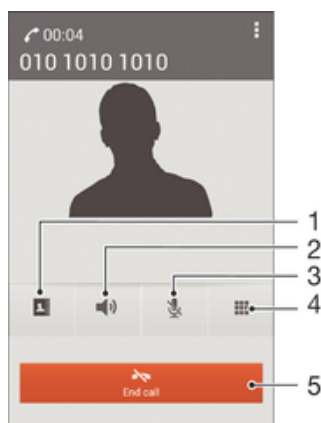

- 1 Open your contacts list
- 2 Turn on the loudspeaker during a call
- 3 Mute the microphone during a call
- 4 Enter numbers during a call
- 5 End a call



To change the ear speaker volume during a call

- Press the volume key up or down.

To activate the screen during a call

- Briefly press .

Using the call log

In the call log, you can view missed calls , received calls  and dialled calls .

To view your missed calls

- 1 When you have missed a call,  appears in the status bar. Drag the status bar downwards.
- 2 Tap **Missed call**.

To call a number from your call log



- 1 From your Home screen, tap .
- 2 Find and tap **Phone**. The call log view appears on the upper part of the screen.
- 3 To call a number directly, tap the number. To edit a number before calling, touch and hold the number, then tap **Edit number before call**.

- ! You can also call a number by tapping  > **Call back**.

To add a number from the call log to your contacts

- 1 From your Home screen, tap .
- 2 Find and tap **Phone**. The call log view appears on the upper part of the screen.
- 3 Touch and hold the number, then tap **Add to Contacts**.
- 4 Tap the desired contact, or tap **Create new contact**.
- 5 Edit the contact details and tap **Done**.

To hide the call log

- 1 From your Home screen, tap .
- 2 Find and tap **Phone**.
- 3 Tap  > **Hide call log**.

Forwarding calls

You can forward calls, for example, to another phone number, or to an answering service.

To forward calls

- 1 From your Home screen, tap .
- 2 Find and tap **Settings** > **Call settings** > **Call forwarding**.
- 3 Select an option.
- 4 Enter the number you want to forward the calls to, then tap **Enable**.

To turn off call forwarding

- 1 From your Home screen, tap .
- 2 Find and tap **Settings** > **Call settings** > **Call forwarding**.
- 3 Select an option, then tap **Disable**.

Restricting calls

You can block all or certain categories of incoming and outgoing calls. If you have received a PIN2 code from your service provider, you can also use a list of Fixed Dialling Numbers (FDNs) to restrict outgoing calls.

To block incoming or outgoing calls

- 1 From your Home screen, tap .
- 2 Find and tap **Settings** > **Call settings**.
- 3 Tap **Call blocking**, and select an option.
- 4 Enter the password and tap **Enable**.

- ! When you set up call blocking for the first time, you need to enter a password to activate the call blocking function. You must use this same password later if you want to edit call blocking settings.

To enable or disable fixed dialling

- 1 From your Home screen, tap .
- 2 Find and tap **Settings** > **Call settings** > **Fixed dialling numbers**.
- 3 Tap **Activate fixed dialling** or **Deactivate fixed dialling**.
- 4 Enter your PIN2 and tap **OK**.

To access the list of accepted call recipients

- 1 From your Home screen, tap .
- 2 Find and tap **Settings** > **Call settings** > **Fixed dialling numbers** > **Fixed dialling numbers**.

Multiple calls

If you have activated call waiting, you can handle multiple calls at the same time. When it is activated, you will be notified by a beep if you receive another call.

To activate or deactivate call waiting

- 1 From the Home screen, tap .
- 2 Find and tap **Settings** > **Call settings** > **Additional settings**.
- 3 To activate or deactivate call waiting, tap **Call waiting**.



To answer a second call and put the ongoing call on hold

- When you hear repeated beeps during a call, drag  to the right.

To reject a second call

- When you hear repeated beeps during a call, drag  to the left.

To make a second call

- 1 During an ongoing call, tap .
- 2 Enter the number of the recipient and tap . The first call is put on hold.

To switch between multiple calls



- To switch to another call and put the current call on hold, tap **Switch to this call**.

Conference calls

With a conference or multiparty call, you can have a joint conversation with two or more persons.

- ! For details about the number of participants that you can add to a conference call, contact your network operator.

To make a conference call

- 1 During an ongoing call, tap .
- 2 Dial the number of the second participant and tap . After the second participant answers, the first participant is put on hold.
- 3 Tap  to add the second participant to the conference call.
- 4 Repeat steps 1 to 3 to add more call participants.

To have a private conversation with a conference call participant

- 1 During an ongoing conference call, tap **{0} participants**.
- 2 Tap the telephone number of the participant with whom you want to talk privately.
- 3 To end the private conversation and return to the conference call, tap .

To release a participant from a conference call

- 1 During an ongoing conference call, tap the button showing the number of participants. For example, tap **3 participants** if there are three participants.
- 2 Tap  next to the participant you want to release.

To end a conference call

- During the conference call, tap **End conference call**.

Voicemail

If your subscription includes a voicemail service, callers can leave voice messages for you when you can't answer calls. Your voicemail service number is normally saved on your SIM card. If not, you can get the number from your service provider and enter it manually.

To enter your voicemail number

- 1 From the Home screen, tap .
- 2 Find and tap **Settings > Call settings > Voicemail > Voicemail settings > Voicemail number**.
- 3 Enter your voicemail number.
- 4 Tap **OK**.





To call your voicemail service

- 1 From your Home screen, tap .
- 2 Find and tap **Phone**.
- 3 Touch and hold **1**.

Emergency calls

Your device supports international emergency numbers, for example, 112 or 911. You can normally use these numbers to make emergency calls in any country, with or without a SIM card inserted if you are within range of a network.

To make an emergency call

- 1 From your Home screen, tap .
 - 2 Find and Tap **Phone**.
 - 3 Enter the emergency number and tap . To delete a number, tap .
-  You can make emergency calls when no SIM card is inserted or when outgoing calls are barred.

To make an emergency call while the SIM card is locked

- 1 From the lock screen, tap **Emergency call**.
- 2 Enter the emergency number and tap .

Contacts

Transferring contacts

There are several ways to transfer contacts to your new device. Find out more about choosing a transfer method at www.sonymobile.com/support.

Transferring contacts using a computer

Xperia™ Transfer and Contacts Setup are applications within the PC Companion and the Sony™ Bridge for Mac computer programs that help you to collect contacts from your old device and transfer them to your new device. These applications support several device brands, including iPhone, Samsung, HTC, BlackBerry, LG, Motorola and Nokia.

You need:

- An Internet-connected computer.
- A USB cable for your old device.
- A USB cable for your new Android™ device.
- Your old device.
- Your new Android™ device.





To transfer contacts to your new device using a computer

- 1 Make sure that *PC Companion* is installed on the PC or that *Sony™ Bridge for Mac* is installed on the Apple® Mac® computer.
- 2 Open the PC Companion application or the Sony™ Bridge for Mac application, then click *Xperia™ Transfer* or *Contacts Setup* and follow the instructions to transfer your contacts.

Transferring contacts using an online account

If you sync the contacts in your old device or your computer with an online account, for example, Google Sync™, Facebook™ or Microsoft® Exchange ActiveSync®, you can transfer your contacts to your new device using that account.



To synchronise contacts to your new device using a synchronisation account

- 1 From your Home screen, tap , then tap .
 - 2 Tap , then tap **Settings > Accounts & sync**.
 - 3 Select the account that you want to sync your contacts with, then tap  > **Sync now**.
- ! You need to be signed in to the relevant sync account before you can sync your contacts with it.

Other methods for transferring contacts

There are several other ways to transfer contacts from your old device to your new device. For example, you can copy contacts to a memory card, use Bluetooth® technology, or save contacts to a SIM card. For more specific information about transferring the contacts from your old device, refer to the relevant User guide.



To import contacts from a memory card

- 1 From your Home screen, tap , then tap .
- 2 Press , then tap **Import contacts > SD card**.
- 3 Select where to store your contacts.
- 4 Select the file that you want to import.

To import contacts using Bluetooth® technology

- 1 Make sure you have the Bluetooth® function turned on and that your device is set to visible.
- 2 When you are notified of an incoming file to your device, drag the status bar downwards and tap the notification to accept the file transfer.
- 3 Tap **Accept** to start the file transfer.
- 4 Drag the status bar downwards. When the transfer is complete, tap the notification.
- 5 Tap the received file and select where to store your contacts.

To import contacts from a SIM card

- ! You may lose information or get multiple contact entries if you transfer contacts using a SIM card.
- 1 From your Home screen, tap , then tap .
 - 2 Tap , then tap **Import contacts > SIM card**.
 - 3 Select where to store your contacts.
 - 4 To import an individual contact, find and tap the contact. To import all contacts, tap **Import all**.

Searching and viewing contacts

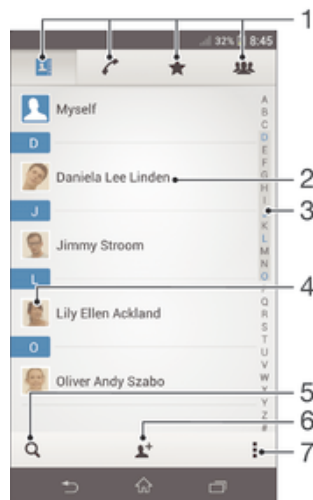

1 Contacts, Calling, Favourites and Groups tabs

2 View contact details

3 Jump to contacts starting with the selected letter



4 Access communication options for the contact

5 Search for contacts



6 Add a contact

7 View more options

To search for a contact



- 1 From your Home screen, tap , then tap .
- 2 Tap  and enter the first few letters of the contact name in the **Search contacts** field. All contacts beginning with those letters appear.

To select which contacts to display in the Contacts application



- 1 From your Home screen, tap , then tap .
- 2 Press , then tap **Filter**.
- 3 In the list that appears, mark and unmark the desired options. If you have synchronised your contacts with a synchronisation account, that account appears in the list. To further expand the list of options, tap the account.
- 4 When you are finished, tap **OK**.

Adding and editing contacts





To add a contact

- 1 From your Home screen, tap , then tap .
 - 2 Tap .
 - 3 If you have synchronised your contacts with one or more accounts and you are adding a contact for the first time, you must select the account to which you want to add this contact. Alternatively, tap **Phone contact** if you only want to use and save this contact on your device.
 - 4 Enter or select the desired information for the contact.
 - 5 When you are finished, tap **Done**.
- ! After you select a synchronisation account in step 3, that account will show as the default account offered the next time you add a contact, but you can change the account by editing the contact after it is saved.
- 💡 If you add a plus sign and the country code before a contact's phone number, you do not have to edit the number again when you make calls from other countries.





To edit a contact

- 1 From your Home screen, tap , then tap .
 - 2 Tap the contact that you want to edit, then tap .
 - 3 Edit the desired information.
 - 4 When you are finished, tap **Done**.
- ! Some synchronisation services do not allow you to edit contact details.



To associate a picture with a contact

- 1 From your Home screen, tap , then tap .
 - 2 Tap the contact you want to edit, then tap .
 - 3 Tap  and select the desired method for adding the contact picture.
 - 4 When you have added the picture, tap **Done**.
- 💡 You can also add a picture to a contact directly from the **Album** application.



To personalise the ringtone for a contact

- 1 From your Home screen, tap , then tap .
- 2 Tap the contact that you want to edit, then tap .
- 3 Tap  > **Set ringtone**.
- 4 Select an option, then tap **Done**.
- 5 Tap **Done**.



To delete contacts

- 1 From your Home screen, tap , then tap .
- 2 Touch and hold the contact that you want to delete.
- 3 To delete all contacts, tap the downwards arrow to open the drop down menu, then select **Mark all**.
- 4 Tap , then tap **Delete**.

To edit contact information about yourself

- 1 From your Home screen, tap , then tap .
- 2 Tap **Myself**, then tap .
- 3 Enter the new information or make the changes you want.
- 4 When you are done, tap **Done**.



To create a new contact from a text message

- 1 From your Home screen, tap , then find and tap .
- 2 Tap  > **Save**.
- 3 Select an existing contact, or tap **Create new contact**.
- 4 Edit the contact information and tap **Done**.



Favourites and groups

You can mark contacts as favourites so that you can get quick access to them from the Contacts application. You can also assign contacts to groups, to get quicker access to them from within the Contacts application.

To mark or unmark a contact as a favourite

- 1 From the Home screen, tap , then tap .
- 2 Tap the contact you want to add to or remove from your favourites.
- 3 Tap .

To view your favourite contacts



- 1 From your Home screen, tap , then tap .
- 2 Tap .

To assign a contact to a group



- 1 In the Contacts application, tap the contact that you want to assign to a group.
- 2 Tap , then tap the bar directly under **Groups**.
- 3 Mark the checkboxes for the groups to which you want to add the contact.
- 4 Tap **Done**.

Sending contact information





To send your business card

- 1 From your Home screen, tap , then tap .
- 2 Tap **Myself**.
- 3 Press , then tap **Send contact** > **OK**.
- 4 Select an available transfer method and follow the on-screen instructions.

To send a contact

- 1 From your Home screen, tap , then tap .
- 2 Tap the contact whose details you want to send.
- 3 Press , then tap **Send contact** > **OK**.
- 4 Select an available transfer method and follow the on-screen instructions.

To send several contacts at once



- 1 From your Home screen, tap , then tap .
- 2 Press , then tap **Mark several**.
- 3 Mark the contacts you want to send, or select all if you want to send all contacts.
- 4 Tap , then select an available transfer method and follow the on-screen instructions.

Avoiding duplicate entries in the Contacts application



If you synchronise your contacts with a new account or import contact information in other ways, you could end up with duplicate entries in the Contacts application. If this

happens, you can join such duplicates to create a single entry. And if you join entries by mistake, you can separate them again later.

To link contacts

- 1 From your Home screen, tap , then tap .
- 2 Tap the contact that you want to link with another contact.
- 3 Press , then tap **Link contact**.
- 4 Tap the contact whose information you want to join with the first contact, then tap **OK** to confirm. The information from the first contact is merged with the second contact, and the linked contacts are displayed as one contact in the Contacts list.



To separate linked contacts

- 1 From your Home screen, tap , then tap .
- 2 Tap the linked contact that you want to edit, then tap .
- 3 Tap **Unlink contact** > **Unlink**.



Backing up contacts

You can use a memory card or a SIM card to back up contacts.

To export all contacts to a memory card

- 1 From your Home screen, tap , then tap .
- 2 Press , then tap **Export contacts** > **SD card**.
- 3 Tap **OK**.

To export contacts to a SIM card

- 1 From your Home screen, tap , then tap .
 - 2 Press , then tap **Export contacts** > **SIM card**.
 - 3 Mark the contacts you want to export, or tap **Mark all** if you want to export all your contacts.
 - 4 Tap **Export**.
 - 5 Select **Add contacts** if you want to add the contacts to existing contacts on your SIM card, or select **Replace all contacts** if you want to replace the existing contacts on your SIM card.
- ! When you export contacts to a SIM card, not all information may get exported. This is due to memory limitations on SIM cards.

Messaging and chat







Reading and sending messages

The Messaging application shows your messages as conversations, which means that all messages to and from a particular person are grouped together. To send multimedia messages, you need the correct MMS settings on your device. See *Internet and messaging settings* on page 33.





- 1 Go back to the list of conversations
- 2 View options
- 3 Sent and received messages
- 4 Send button
- 5 Attach a file
- 6 Attach a location
- 7 Attach a sound clip
- 8 Take a photo and attach it
- 9 Attach a photo saved on your device
- 10 Text field

To create and send a message



- 1 From your Home screen, tap , then find and tap .
- 2 Tap .
- 3 Tap , then tap **Add recipient** and select a contact from the Contacts list. If the recipient is not listed as a contact, enter the recipient's number manually and tap .
- 4 When you are finished adding recipients, tap **Done**.
- 5 Tap **Write message** and enter your message text.
- 6 If you want to add a media file, tap  and select an option.
- 7 To send the message, tap **Send**.

 If you exit a message before sending, it gets saved as a draft. The conversation gets tagged with the word **Draft**.



To read a received message

- 1 From your Home screen, tap , then find and tap .
- 2 Tap the desired conversation.
- 3 If the message is not yet downloaded, tap and hold the message, then tap **Download message**.

To reply to a message



- 1 From your Home screen, tap , then find and tap .
- 2 Tap the conversation containing the message.
- 3 Enter your reply and tap **Send**.

To forward a message

- 1 From your Home screen, tap , then find and tap .
- 2 Tap the conversation containing the message that you want to forward.
- 3 Touch and hold the message that you want to forward, then tap **Forward message**.
- 4 Tap , then tap **Add recipient** and select a contact from the Contacts list. If the recipient is not listed as a contact, enter the contact's number manually and tap **+**.
- 5 When you are finished adding recipients, tap **Done**.
- 6 Edit the message, if necessary, then tap **Send**.



 In step 4, you can also tap **To** and enter the recipient's phone number manually.

To save a file contained in a message you receive





- 1 From your Home screen, tap , then find and tap .
- 2 Tap the conversation you want to open.
- 3 If the message has not been downloaded yet, tap and hold the message, then tap **Download message**.
- 4 Touch and hold the file you want to save, then select the desired option.

Organising your messages





To delete a message

- 1 From your Home screen, tap , then find and tap .
- 2 Tap the conversation containing the message you want to delete.
- 3 Touch and hold the message you want to delete, then tap **Delete message** > **Delete**.



To delete conversations

- 1 From your Home screen, tap , then find and tap .
- 2 Tap , then tap **Delete conversations**.
- 3 Mark the checkboxes for the conversations that you want to delete, then tap  > **Delete**.



To star a message

- 1 From your Home screen, tap , then find and tap .
- 2 Tap the conversation you want to open.
- 3 In the message you want to star, tap .
- 4 To unstar a message, tap .

To view starred messages



- 1 From your Home screen, tap , then find and tap .
- 2 Tap , then tap **Starred messages**.
- 3 All starred messages appear in a list.

To search for messages



- 1 From your Home screen, tap , then find and tap .
- 2 Tap , then tap **Search**.
- 3 Enter your search keywords. The search results appear in a list.

Calling from a message

To call a message sender



- 1 From your Home screen, tap , then find and tap .
- 2 Tap a conversation.
- 3 Tap the recipient name or number at the top of the screen, then select the recipient name or number from the list that appears.
- 4 If the recipient is saved in your contacts, tap the phone number that you want to call. If you have not saved the recipient in your contacts, tap .

To save a sender's number as a contact



- 1 From your Home screen, tap , then find and tap .
- 2 Tap  > **Save**.
- 3 Select an existing contact, or tap **Create new contact**.
- 4 Edit the contact information and tap **Done**.

Messaging settings

To change your message notification settings

- 1 From your Home screen, tap , then find and tap .
- 2 Tap , then tap **Settings**.
- 3 To set a notification sound, tap **Notification tone** and select an option.
- 4 For other notification settings, check or uncheck the relevant checkboxes.

To change the delivery report settings for outgoing messages

- 1 From your Home screen, tap , then find and tap .
- 2 Tap , then tap **Settings**.
- 3 Tap **Delivery report** to activate or deactivate delivery reports.

Instant messaging and video chat

You can use the Google Hangouts™ instant messaging and video chat application on your device to chat with friends who also use the application on computers, Android™ devices and other devices. You can turn any conversation into a video call with several friends, and you can send messages to friends even when they are offline. You can also view and share photos easily.

Before you start using Hangouts™, make sure that you have a working Internet connection and a Google™ account. Go to <http://support.google.com/hangouts> and click the "Hangouts on your Android" link to get more detailed information about how to use this application.

- ! The video call function only works on devices with a front camera.

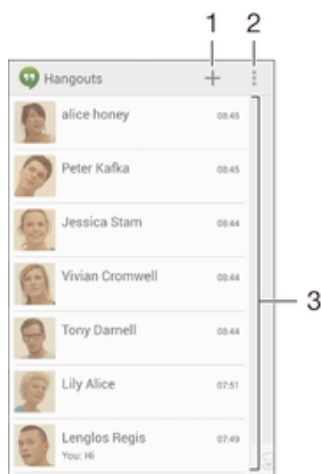





1 Start a new chat or video call



2 Options

3 List of contacts

To start an instant message or a video call

- 1 From your Home screen, tap .
- 2 Find and tap **Hangouts**.
- 3 Tap , then enter a contact name, email address, phone number or circle name and select the relevant entry from the suggested list.
- 4 To start an instant messaging session, tap .
- 5 To start a video call, tap .

To reply to a chat message or join a video call

- 1 When someone contacts you on **Hangouts**,  or  appears in the status bar.
- 2 Drag the status bar downwards, then tap the message or video call and begin to chat.

To learn more about Hangouts™



- When the Hangouts™ application is open, tap , then tap **Help**.

Email



Setting up email

Use the email application in your device to send and receive email messages through your email accounts. You can have one or several email accounts at the same time, including corporate Microsoft Exchange ActiveSync accounts.



To set up an email account

- 1 From your Home screen, tap .
 - 2 Find and tap **Email**.
 - 3 Follow the instructions that appear on the screen to complete the setup.
-  For some email services, you may need to contact your email service provider for information on detailed settings for the email account.

To add an extra email account

- 1 From your Home screen, tap .
- 2 Find and tap **Email**.
- 3 If you are using several email accounts, tap , then tap **Add account**.
- 4 Enter the email address and password, then tap **Next**. If the settings for the email account cannot be downloaded automatically, complete the setup manually.
- 5 When prompted, enter a name for your email account so that it is easily identifiable.
- 6 When you are finished, tap **Next**.

To set an email account as your default account



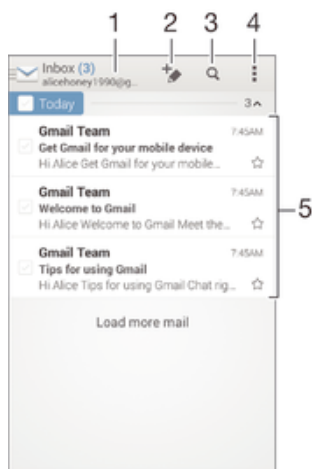

- 1 From your Home screen, tap .
 - 2 Find and tap **Email**.
 - 3 Press , then tap **Settings**.
 - 4 Select the account you want to use as the default account for composing and sending email messages.
 - 5 Mark the **Default account** checkbox. The inbox of the default account appears every time you open the email application.
-  If you only have one email account, this account is automatically the default account.

Sending and receiving email messages





- 1 View a list of all email accounts and recent folders
- 2 Write a new email message
- 3 Search for email messages





To download new email messages

- 1 From your Home screen, tap .
 - 2 Find and tap **Email**.
 - 3 If you are using several email accounts, tap  and select the **Inbox** of the account that you want to check.
 - 4 To download new messages, tap .
-  When the inbox is open, swipe downwards on the screen to refresh the message list.

To read your email messages

- 1 From your Home screen, tap .
- 2 Find and tap **Email**.
- 3 If you are using several email accounts, tap  and select the account that you want to check, then tap **Inbox** in the drop down menu. If you want to check all your email accounts at once, tap , then tap **Combined inbox** in the drop down menu.
- 4 In the email inbox, scroll up or down and tap the email message that you want to read.



To create and send an email message

- 1 From your Home screen, tap , then find and tap **Email**.
- 2 If you are using several email accounts, tap  and select the account from which you want to send the email, then tap **Inbox** in the drop down menu.
- 3 Tap , then type the recipient's name or email address, or tap  and select one or more recipients from your Contacts list.
- 4 Enter the email subject and message text, then tap .

To reply to an email message

- 1 In your email inbox, find and tap the message that you want to reply to, then tap **Reply** or **Reply all**.
- 2 Enter your reply, then tap .

To forward an email message

- 1 In your email inbox, find and tap the message that you want to forward, then tap **Forward**.
- 2 Enter the recipient's email address manually, or tap  and select a recipient from your Contacts list.
- 3 Enter your message text, then tap .

To view an email message attachment

- 1 Find and tap the email message containing the attachment that you want to view. Email messages with attachments are indicated by .
- 2 After the email message opens, tap **Load**. The attachment starts to download.
- 3 After the attachment finishes downloading, tap **View**.

To save a sender's email address to your contacts



- 1 Find and tap a message in your email inbox.
- 2 Tap the name of the sender, then tap **OK**.
- 3 Select an existing contact, or tap **Create new contact**.
- 4 Edit the contact information, if desired, then tap **Done**.

Email preview pane

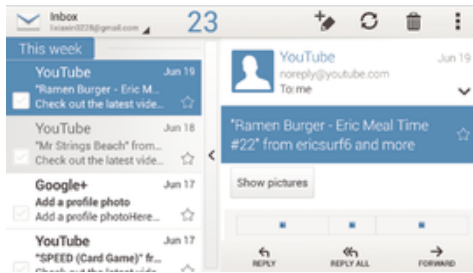
A preview pane is available for viewing and reading your email messages in landscape orientation. Once activated, you can use it to view both the email message list and one selected email message at the same time.



To activate the preview pane





- 1 From your Home screen, tap , then find and tap **Email**.
- 2 Tap , then tap **Settings**.
- 3 Tap **General > Preview pane**.
- 4 Select an option, or a combination of options, then tap **OK**.

To read email messages using the preview pane





- 1 Make sure the preview pane is activated.
- 2 Open your email inbox.
- 3 Scroll up or down and tap the email message that you want to read.
- 4 To view the email message in fullscreen format, tap the split bar (located between the email list and the email body).
- 5 To return to the regular inbox view, tap the split bar again.

Organising your email messages



To sort your emails

- 1 From your Home screen, tap .
- 2 Find and tap **Email**.
- 3 If you are using several email accounts, tap  and select the account that you want to sort, then tap **Inbox** in the drop down menu. If you want to sort all your email accounts at once, tap , then tap **Combined inbox**.
- 4 Tap , then tap **Sort**.
- 5 Select a sorting option.



To search for emails

- 1 From your Home screen, tap .
- 2 If you are using several email accounts, tap  and select the name of the account that you want to check, then tap **Inbox** in the drop down menu. If you want to search all your email accounts at once, tap , then tap **Combined view**.
- 3 Tap .
- 4 Enter your search text, then tap  on the keyboard.
- 5 The search result appears in a list sorted by date. Tap the email message that you want to open.

To view all folders for one email account



- 1 From your Home screen, tap .
- 2 If you are using several email accounts, tap , and select the account you want to check.
- 3 Under the account that you want to check, select **Show all folders**.

To delete an email message



- 1 In your email inbox, mark the checkbox for the message that you want to delete, then tap .
 - 2 Tap **Delete**.
-  In the email inbox view, you can also flick a message to the right to delete it.

Email account settings





To remove an email account from your device

- 1 From your Home screen, tap .
- 2 Find and tap **Email**.
- 3 Press , then tap **Settings**.
- 4 Select the account you want to remove.
- 5 Tap **Delete account** > **OK**.

To change the inbox check frequency

- 1 From your Home screen, tap .
- 2 Find and tap **Email**.
- 3 Tap , then tap **Settings**.
- 4 Select the account for which you want to change the inbox check frequency.
- 5 Tap **Inbox check frequency** > **Check frequency** and select an option.

To set an Out of Office auto-reply in an Exchange Active Sync account

- 1 From your Home screen, tap , then find and tap **Email**.
- 2 Press , then tap **Settings**.
- 3 Select the EAS (Exchange Active Sync) account for which you want to set an Out of Office auto-reply.
- 4 Tap **Out of office**.
- 5 Tap  beside **Out of office** so that  changes to .
- 6 If needed, mark the **Set time range** checkbox and set the time range for the auto reply.
- 7 Enter your Out of Office message in the body text field.
- 8 Tap **OK** to confirm.

Gmail™

If you have a Google™ account, you can use the Gmail™ application to read and write email messages.

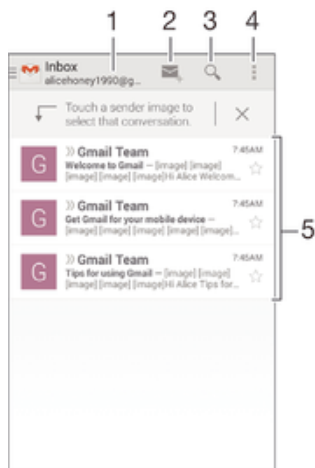

- 1 View a list of all Gmail accounts and recent folders
- 2 Write a new email message
- 3 Search for email messages
- 4 Access settings and options
- 5 List of email messages

To learn more about Gmail™

- When the Gmail application is open, tap , then tap **Help**.

Music

Transferring music to your device

There are different ways to get music from a computer to your device:

- Connect the device and computer using a USB cable and drag and drop music files directly into the file manager application on the computer. See *Connecting your device to a computer* on page 94.
- If the computer is a PC, you can use the Media Go™ application from Sony and organise your music files, create playlists, subscribe to podcasts, and more. To learn more and download the Media Go™ application, go to <http://mediago.sony.com/enu/features>.
- If the computer is an Apple® Mac®, you can use the Sony™ Bridge for Mac application to transfer your media files from iTunes to your device. To learn more and download Sony™ Bridge for Mac, go to www.sonymobile.com/global-en/tools/bridge-for-mac/.

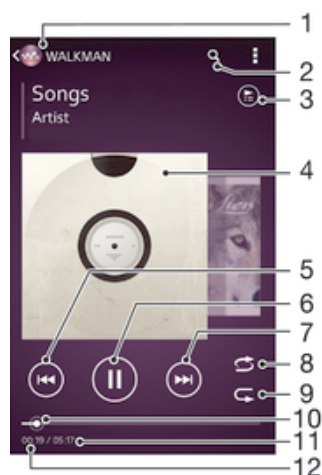

Listening to music

Use the "WALKMAN" application to listen to your favourite music and audio books.



- 1 Browse your music
- 2 Search songs on Music Unlimited and all songs saved to your device
- 3 View the current play queue
- 4 Album art (if available)
- 5 Tap to go to the previous song in the play queue
Touch and hold to rewind within the current song
- 6 Play or pause a song
- 7 Tap to go to the next song in the play queue
Touch and hold to fast forward within the current song
- 8 Shuffle songs in the current play queue
- 9 Repeat all songs in the current play queue
- 10 Progress indicator – Drag the indicator or tap along the line to fast forward or rewind
- 11 Total time length of current song
- 12 Elapsed time of current song

To play a song

- 1 From your Home screen, tap , then find and tap .
- 2 If the WALKMAN home screen is not displayed, tap .
- 3 Select a music category, for example, under **Artists**, **Albums** or **Songs**, then browse to the song that you want to open.
- 4 Tap a song to play it.

- ! You might not be able to play copyright-protected items. Please verify that you have necessary rights in material that you intend to share.

To find song-related information online

- While a song is playing in the "WALKMAN" application, tap the album art to display the infinite button , then tap .
- 💡 The infinite button  gives you access to several sources of information including videos on YouTube™, lyrics, and artist info on Wikipedia.

To adjust the audio volume

- Press the volume key.

To minimise the "WALKMAN" application

- When a song is playing, tap  to go to the Home screen. The "WALKMAN" application stays playing in the background.

To open the "WALKMAN" application when it is playing in the background

- 1 While a song is playing in the background, tap the  to open the recently used applications window.
- 2 Tap the "WALKMAN" application.

WALKMAN home screen

The WALKMAN home screen gives you an overview of all the songs on your device as well as of the songs available on Music Unlimited. From here you can manage your albums and playlists, create shortcuts, and organise your music by mood and tempo using SensMe™ channels.

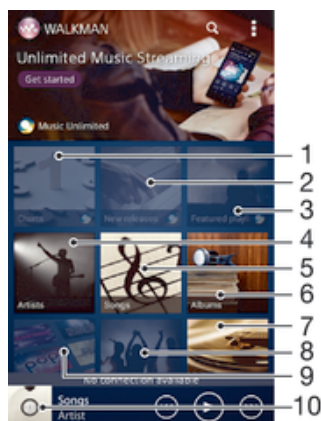



- 1 Charts provided by Music Unlimited
- 2 New releases provided by Music Unlimited
- 3 Featured playlists provided by Music Unlimited
- 4 Browse your music by artist
- 5 Browse your music by song
- 6 Browse your music by album

- 7 Browse all playlists
- 8 Collect links to music and related content that you and friends have shared using online services
- 9 Manage and edit your music using Music Unlimited channels
- 10 Open the "WALKMAN" music player

! Sony Entertainment Network with Video Unlimited and Music Unlimited is not available in every market. Separate subscription required. Additional terms and conditions apply.

To display the WALKMAN home screen

- 1 From the Home screen, tap  > .
- 2 If the WALKMAN home screen is not displayed, tap .

To add a shortcut to a song

- 1 From the WALKMAN home screen, browse to the song for which you want to create a shortcut.
- 2 Touch and hold the song title.
- 3 Tap **Add as shortcut**. The shortcut now appears in the WALKMAN home screen.

! You cannot add shortcuts to songs from Music Unlimited.

To rearrange shortcuts

- From the WALKMAN home screen, touch and hold a shortcut until it magnifies and your device vibrates, then drag the item to a new location.

To delete a shortcut

- From the WALKMAN home screen, touch and hold a shortcut until it magnifies and your device vibrates, then drag the item to .

! You can only delete shortcuts that you create yourself.

💡 You can also drag default shortcuts to  but they only get hidden, not deleted.

To update your music with the latest information

- 1 From the WALKMAN home screen, tap .
- 2 Tap **Download music info** > **Start**. Your device searches online and downloads the latest available album art and song information for your music.

💡 The SensMe™ channels application is activated when you download music information.

To enable the SensMe™ channels application

- From the WALKMAN home screen, tap , then tap **Download music info** > **Start**.

! This application requires a mobile or Wi-Fi® network connection.

To delete a song

- 1 Open the WALKMAN home screen, then browse to the song that you want to delete.
- 2 Touch and hold the song title, then tap **Delete**.

💡 You can also delete albums this way.

Playlists

On the WALKMAN home screen, you can create your own playlists from the music that is saved on your device.

To create your own playlists

- 1 Open the WALKMAN home screen.
- 2 To add an artist, album or a song to a playlist, touch and hold the name of the artist or the title of the album or song.
- 3 In the menu that opens, tap **Add to > Create new playlist**.
- 4 Enter a name for the playlist and tap **OK**.

💡 You can also tap the album art and then tap **+** to create a new playlist.

To add songs to a playlist

- 1 Open the WALKMAN home screen.
- 2 Browse to the song or album that you want to add to a playlist, then touch and hold the song or the album title.
- 3 Tap **Add to**.
- 4 Tap the name of the playlist to which you want to add the album or song. The album or song is added to the playlist.

To play your own playlists

- 1 Open the WALKMAN home screen, then tap **Playlists**.
- 2 Under **Playlists**, tap a playlist.
- 3 Tap a song to play it.

To remove a song from a playlist

- 1 In a playlist, touch and hold the title of the song you want to delete.
- 2 Tap **Delete from playlist** from the list that appears.

To delete a playlist

- 1 Open the WALKMAN home screen, then tap **Playlists**.
- 2 Touch and hold the playlist that you want to delete.
- 3 Tap **Delete**.
- 4 Tap **Delete** again to confirm.

! You cannot delete default playlists.

Sharing music

To send a song

- 1 Open the WALKMAN home screen.
- 2 Browse to the song or album that you want to send, then touch and hold the song title.
- 3 Tap **Share**.
- 4 Select an application from the list, then follow the on-screen instructions.

💡 You can also send albums and playlists in the same way.

Sharing music on Facebook™

The Friends' music function collects links to music and music-related content that you and your friends have shared using Facebook™.

To "Like" a song on Facebook™

- 1 While the song is playing in the "WALKMAN" application, tap the album art.
- 2 Tap **👍** to show that you "Like" the song on Facebook™. If desired, add a comment in the comments field.
- 3 Tap **Share** to send the song to Facebook™. If the song is received successfully, you will get a confirmation message from Facebook™.

To manage music from your friends



- 1 Open the WALKMAN home screen, then tap **Friends' music > Recent**.
- 2 Tap an item to open it, then work on it as desired.
- 3 Tap  to show that you "Like" the song on Facebook™. If desired, add a comment in the comments field.

To view your shared music

- 1 Open the WALKMAN home screen, then tap **Friends' music > My shares**.
- 2 Scroll to an item that you want to open, then tap it. All comments about the item, if any, are displayed.

Enhancing the sound

To improve the sound quality using the Equaliser

- 1 When a song is playing in the "WALKMAN" application, tap .
- 2 Tap **Settings > Sound effects > Sound enhancements**.
- 3 To adjust the sound manually, drag the frequency band buttons up or down. To adjust the sound automatically, tap  and select a style.



To turn on the surround sound

- 1 When the "WALKMAN" application is open, tap .
- 2 Tap **Settings > Sound effects > Sound enhancements > Settings > Surround sound (VPT)**.
- 3 Select a setting, then tap **OK** to confirm.



Visualiser

The Visualiser adds visual effects to your songs as you play them. The effects for each song are based on the characteristics of the music. They change, for example, in response to changes in the music's loudness, rhythm and frequency level. You can also change the background theme.

To turn on the Visualiser

- 1 In the "WALKMAN" application, tap .
 - 2 Tap **Visualizer**.
-  Tap the screen to switch to full screen view.

To change the background theme

- 1 In the "WALKMAN" application, tap .
- 2 Tap **Visualizer**.
- 3 Tap  > **Theme** and select a theme.

Recognising music with TrackID™



Use the TrackID™ music recognition service to identify a music track you hear playing in your surroundings. Just record a short sample of the song and you'll get artist, title and album info within seconds. You can purchase tracks identified by TrackID™ and you can view TrackID™ charts to see what TrackID™ users around the globe are searching for. For best results, use TrackID™ technology in a quiet area.



- 1 View TrackID options
- 2 View current music charts
- 3 View the search result history
- 4 Record and identify music

! The TrackID™ application and the TrackID™ service are not supported in all countries/regions, or by all networks and/or service providers in all areas.

To identify music using TrackID™ technology

- 1 From your Home screen, tap 
 - 2 Find and tap **TrackID™**, then hold your device towards the music source.
 - 3 Tap . If the track is recognised by the TrackID™ service, the results appear on the screen.
- 💡 To return to the TrackID™ start screen, press .

To view TrackID™ charts

- Open the TrackID™ application, then tap **Charts**. A chart from your own region is shown.

To view TrackID™ charts from another region

- 1 Open the TrackID™ application, then tap **Charts**.
- 2 Tap  > **Regions** and then select a country or region.

To buy a track recognised by the TrackID™ application

- 1 After a track has been recognised by the TrackID™ application, tap **Download**.
 - 2 Follow the instructions in your device to complete your purchase.
- 💡 You can also select a track to buy by opening the **History** or **Charts** tabs from the TrackID™ start screen.

To share a track

- 1 After a track has been recognised by the TrackID™ application, tap **Share**, then select a sharing method.
- 2 Follow the instructions on your device to complete the procedure.

To view artist information for a track

- After a track has been recognised by the TrackID™ application, tap **Artist info**.

To delete a track from the track history

- 1 Open the TrackID™ application, then tap **History**.
- 2 Tap a track title, then tap **Delete**.
- 3 Tap **Yes** to confirm.

Music Unlimited online service

Music Unlimited is a subscription-based service that offers access to millions of songs over a mobile network or Wi-Fi® connection. You can manage and edit your personal music library in the cloud from a variety of devices, or sync your playlists and music using a PC that runs the Windows® operating system. Go to www.sonyentertainmentnetwork.com for more information.

- ! Sony Entertainment Network with Video Unlimited and Music Unlimited is not available in every market. Separate subscription required. Additional terms and conditions apply.

To get started with Music Unlimited

- 1 Open the **WALKMAN** home screen.
- 2 Tap **Music Unlimited**, then follow the on-screen instructions to get started with the Music Unlimited service.

FM radio

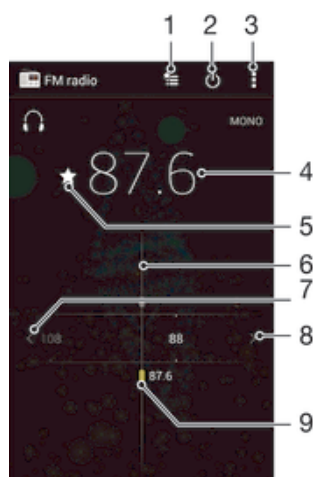

Listening to the radio

The FM radio in your device works like any FM radio. For example, you can browse and listen to FM radio stations and save them as favourites. You must connect a wired headset or headphones to your device before you can use the radio. This is because the headset or headphones act as an antenna. After one of these devices is connected, you can then switch the radio sound to the speaker, if desired.



- 1 Favourites list
- 2 Radio on/off button
- 3 View menu options
- 4 Tuned frequency
- 5 Save or remove a channel as a favourite
- 6 Tuning dial
- 7 Move left the frequency band to search for a channel
- 8 Move right the frequency band to search for a channel
- 9 A saved favourite channel

To listen to the FM radio

- 1 Connect a headset or a set of headphones to your device.
 - 2 From your Home screen, tap .
 - 3 Find and tap **FM radio** . The available channels appear as you scroll through the frequency band.
- ! When you start the FM radio, available channels appear automatically. If a channel has RDS information, it appears a few seconds after you start listening to the channel.



To move between radio channels

- Drag the frequency band left or right.



To start a new search for radio channels

- 1 When the radio is open, press .
- 2 Tap **Search for channels**. The radio scans the whole frequency band, and all available channels are displayed.

To switch the radio sound to the speaker

- 1 When the radio is open, press .
 - 2 Tap **Play in speaker**.
-  To switch the sound back to the wired headset or headphones, press  and tap **Play in headphones**.

To identify a song on the FM radio using TrackID™

- 1 While the song is playing on your device's FM radio, press , then select **TrackID™**.
 - 2 A progress indicator appears while the TrackID™ application samples the song. If successful, you are presented with a track result, or a list of possible tracks.
 - 3 Press  to return the FM Radio.
-  The TrackID™ application and the TrackID™ service are not supported in all countries/regions, or by all networks and/or service providers in all areas.

Favourite radio channels

To save a channel as a favourite

- 1 When the radio is open, navigate to the channel that you want to save as a favourite.
- 2 Tap .
- 3 Enter a name and select a colour for the channel, then press **Save**.

To listen to a favourite radio channel



- 1 Tap .
- 2 Select an option.

To remove a channel as a favourite

- 1 When the radio is open, navigate to the channel that you want to remove.
- 2 Tap , then tap **Delete**.

Sound settings

To switch between mono and stereo sound mode

- 1 When the radio is open, press .
- 2 Tap **Enable stereo sound**.
- 3 To listen to the radio in mono sound mode again, press  and tap **Force mono sound**.

To select the radio region

- 1 When the radio is open, press .
- 2 Tap **Set radio region**.
- 3 Select an option.

To adjust the Visualiser

- 1 When the radio is open, tap .
- 2 Tap **Visualizer**.
- 3 Select an option.



Camera

Taking photos and recording videos



- 1 Camera key – Activate the camera/Take photos/Record videos
- 2 View photos and videos
- 3 Take photos or record video clips
- 4 Go back a step or exit the camera
- 5 Capturing mode settings icon
- 6 Camera settings icon and shortcut icons
- 7 Front camera
- 8 Main camera screen
- 9 Zoom in or out

To take a photo from the lock screen

- 1 To activate the screen, briefly press the power key .
- 2 To activate the camera, swipe to the left in the upper part of the screen.
- 3 After the camera opens, tap .

To take a photo using the camera key

- 1 Activate the camera.
- 2 Press the camera key fully down.

To take a photo by tapping the on-screen camera button

- 1 Activate the camera.
- 2 Point the camera towards the subject.
- 3 Tap the on-screen camera button . The photo is taken as soon as you release your finger.



To take a self-portrait using the front camera

- 1 Activate the camera.
- 2 Tap .
- 3 To take the photo, press the camera key. The photo is taken as soon as you release your finger.



To use the still camera flash

- 1 When the camera is open, tap .
- 2 Select your desired flash setting.
- 3 Take the photo.

To record a video using the camera key

- 1 Activate the camera.
- 2 Tap , and select .
- 3 If the video camera is not selected, tap .
- 4 To start recording a video, press the camera key.
- 5 To stop recording, press the camera key again.

To record a video by tapping the screen



- 1 Activate the camera.
- 2 Point the camera towards the subject.
- 3 Tap  to start recording.
- 4 Tap  to stop recording.

! This function is only available in Superior auto capturing mode.

To view your photos and videos

- 1 Activate the camera, then tap a thumbnail to open a photo or video.
- 2 Flick left or right to view your photos and videos.





To delete a photo or recorded video

- 1 Browse to the photo or video that you want to delete.
- 2 Tap the screen to make  appear.
- 3 Tap .
- 4 Tap **Delete** to confirm.

Face detection

You can use face detection to bring an off-centre face into focus. The camera automatically detects up to five faces, indicated by white frames. A yellow frame shows which face has been selected for focus. Focus is set to the face closest to the camera. You can also tap one of the frames to select which face should be in focus.

To turn on face detection

- 1 Activate the camera.
- 2 Tap , then select .
- 3 Tap , then tap .
- 4 Tap **Focus mode** > **Face detection**.



To take a photo using face detection

- 1 When the camera is open and **Face detection** turned on, point the camera at your subject. Up to five faces can be detected, and each detected face is framed.
- 2 Press the camera key halfway down. A yellow frame shows which face is in focus.
- 3 To take the photo, press the camera key fully down.

Using Smile Shutter™ to capture smiling faces

Use Smile Shutter™ technology to photograph a face just as it smiles. The camera detects up to five faces and selects one face for smile detection and auto focus. When the selected face smiles, the camera automatically takes a photo.

To turn on Smile Shutter™



- 1 Activate the camera.
- 2 Tap , then tap .
- 3 Tap **Smile Shutter** and select a smile level.

To take a photo using Smile Shutter™



- 1 When the camera is open and Smile Shutter™ is turned on, point the camera at your subject. The camera selects which face to focus on.
- 2 The face selected appears inside a coloured frame and the photo is taken automatically.
- 3 If no smile is detected, press the camera key to take the photo manually.

Adding the geographical position to your photos

Turn on geotagging to add the approximate geographical location (a geotag) to photos when you take them. The geographical location is determined either by wireless networks (mobile or Wi-Fi® networks) or GPS technology.





When  appears on the camera screen, geotagging is turned on but the geographical position has not been found. When  appears, geotagging is turned on and the geographical location is available, so your photo can get geotagged. When neither of these two symbols appears, geotagging is turned off.

To turn on geotagging

- 1 From your Home screen, tap .
- 2 Tap **Settings** > **Location services**.
- 3 Drag the slider beside **Access to my location** to the right.
- 4 Activate the camera.
- 5 Tap , then tap .
- 6 Drag the slider beside **Geotagging** to the right.
- 7 Tap **OK**.

General camera settings

Capturing mode settings overview

-  **Superior auto**
Optimise your settings to suit any scene.
-  **Manual**
Adjust camera settings manually.
-  **Picture effect**
Apply effects to photos.
-  **Sweep Panorama**
Use this setting to take wide-angle, panoramic photos. Just press the camera key and move the camera steadily from one side to the other.

Quick launch

Use Quick launch settings to launch the camera when the screen is locked.

Launch only

When this setting is activated, you can launch the camera when the screen is locked by pressing and holding down the camera key.

Launch and capture

When this setting is activated, you can launch the camera and capture a photo automatically when the screen is locked by pressing and holding down the camera key.

Launch and record video

When this setting is activated, you can launch the camera and start capturing video when the screen is locked by pressing and holding down the camera key.

Off

Geotagging

Tag photos with details of where you took them.

Touch capture

Identify a particular focus area by touching the camera screen with your finger. The photo is taken as soon as you release your finger. This setting is only available when focus mode is set to touch focus.

Shutter sound

Choose to turn on or turn off the shutter sound when you record a video.

Data storage

You can choose to save your data either to a removable SD card or to your device's internal storage.

Internal storage

Photos or videos are saved on the device memory.

SD card

Photos or videos are saved on the SD card.

White balance

This function adjusts the colour balance according to the lighting conditions. The white balance setting icon  is available on the camera screen.



Auto

Adjusts the colour balance automatically to suit the lighting conditions.



Incandescent

Adjusts the colour balance for warm lighting conditions, such as under light bulbs.



Fluorescent

Adjusts the colour balance for fluorescent lighting.



Daylight

Adjusts the colour balance for sunny outdoor conditions.



Cloudy

Adjusts the colour balance for a cloudy sky.

! This setting is only available in Manual capturing mode.

Still camera settings

To adjust the still camera settings

- 1 Activate the camera.
- 2 To display all settings, tap .
- 3 Select the setting that you want to adjust, then edit as desired.

Still camera settings overview

Resolution

Choose between several resolutions and aspect ratios before taking a photo. A photo with a higher resolution requires more memory.

13MP

4128×3096(4:3)

13 megapixel resolution with 4:3 aspect ratio. Suitable for photos you want to view on non-widescreen displays or print in high resolution.

9MP

3920×2204(16:9)

9 megapixel resolution with 16:9 aspect ratio. Suitable for photos you want to view on widescreen displays.

5MP

2592×1944(4:3)

5 megapixel resolution with 4:3 aspect ratio. Suitable for photos you want to view on non-widescreen displays or print in high resolution.

2MP

1920×1080(16:9)

2 megapixel resolution with 16:9 aspect ratio. Suitable for photos you want to view on widescreen displays.

- ! This setting is only available in **Manual** capturing mode.

Self-timer

With the self-timer you can take a photo without holding the device. Use this function to take self-portraits, or group photos where everyone can be in the photo. You can also use the self-timer to avoid shaking the camera when taking photos.

On (10 sec.)

Set a 10-second delay from when you tap the camera screen until the photo is taken.

On (2 sec.)

Set a 2-second delay from when you tap the camera screen until the photo is taken.

Off

The photo is taken as soon as you tap the camera screen.

Smile Shutter™

Use the Smile Shutter™ function to determine what kind of smile the camera reacts to before taking a photo.

Focus mode

The focus function controls which part of a photo should be sharp. When continuous autofocus is on, the camera keeps adjusting focus so that the area within the yellow focus frame stays sharp.

Single autofocus

The camera automatically focuses on the selected subject. Continuous autofocus is on. Touch and hold the camera screen until the yellow focus frame turns blue, indicating that the focus is set. The photo is taken when you release your finger.

Multi autofocus

The focus is automatically set on several areas of the image. Touch and hold the camera screen until the yellow focus frame turns blue, indicating that the focus is set. The photo is taken when you release your finger. Continuous autofocus is off.

Face detection

The camera automatically detects up to five human faces, indicated by frames on the screen. The camera automatically focuses on the nearest face. You can also select which face to focus on by tapping it on the screen. When you tap the camera screen, a blue frame shows which face is selected and in focus. Face detection cannot be used for all scene types. Continuous autofocus is on.

Touch focus

Touch a specific area on the camera screen to set the area of focus. Continuous autofocus is off. Touch and hold the camera screen until the yellow focus frame turns blue, indicating that the focus is set. The photo is taken when you release your finger.

- ! This setting is only available in **Manual** capturing mode.

ISO

You can reduce image blurring caused by dark conditions or moving subjects by increasing the ISO sensitivity.

Auto

Sets the ISO sensitivity automatically.

100

Sets the ISO sensitivity to 100.

200

Sets the ISO sensitivity to 200.

400

Sets the ISO sensitivity to 400.

800

Sets the ISO sensitivity to 800.

- ! This setting is only available in **Manual** capturing mode.

Metering

This function automatically determines a well-balanced exposure by measuring the amount of light striking the image you want to capture.

Center

Adjusts the exposure to the centre of the image.

Average

Calculates the exposure based on the amount of light striking the whole image.

Spot

Adjusts the exposure in a very small part of the image that you want to capture.

- ! This setting is only available in **Manual** capturing mode.

Image stabiliser

When taking a photo, it can be difficult to hold the device steady. The stabiliser helps you by compensating for small movements of the hand.

- ! This setting is only available in **Manual** capturing mode.

Preview

You can choose to preview photos or videos just after you shoot them.

Unlimited

The preview of the photo or video appears after you shoot it.

5 seconds

The preview of the photo or video appears for 5 seconds after you shoot it.

3 seconds

The preview of the photo or video appears for 3 seconds after you shoot it.

Edit

The photo or video opens for editing after you shoot it.

Off

The photo or video is saved after you shoot it, and no preview appears.

Flash

Use the flash to take photos when lighting conditions are poor or when there is a backlight. The following options are available when you tap the flash icon  in the camera screen:

Auto

The camera automatically determines if the lighting conditions require the use of a flash.



Fill flash

Use this setting when the background is brighter than the subject. This removes unwanted dark shadows.



Red-eye reduction

Reduces the red colour of eyes when taking a photo.



Off



The flash is turned off. Sometimes photo quality can be better without the flash, even if lighting conditions are poor. Taking a good photo without using the flash requires a steady hand. Use the self-timer to avoid blurred photos.

Flashlight

A torch or camera light is turned on when you take photos.



Video camera settings

To adjust the video camera settings

- 1 Activate the camera.
- 2 Tap one of the settings icons on the screen.
- 3 To display all settings, tap .
- 4 Select the setting that you want to adjust, then make your changes.

Video camera settings overview

Video resolution

Adjust the video resolution for different formats.

Full HD

1980×1080(16:9)

Full HD (Full High Definition) format with 16:9 aspect ratio. 1980×1080 pixels.

HD

1280×720(16:9)

HD (High Definition) format with 16:9 aspect ratio. 1280×720 pixels.

MMS

Record videos suitable for sending in multimedia messages. The recording time of this video format is limited to fit in a multimedia message.

- ! This setting is only available in **Manual** capturing mode.

Self-timer

With the self-timer you can record a video without holding the device. Use it to record group videos where everyone can be in the video. You can also use the self-timer to avoid shaking the camera when recording videos.

On (10 sec.)

Set a 10-second delay from when you tap the camera screen until the video begins to record.

On (2 sec.)

Set a 2-second delay from when you tap the camera screen until the video begins to record.

Off

The video begins to record as soon as you tap the camera screen.

Focus mode

The focus setting controls which part of a video should be sharp. When continuous autofocus is on, the camera keeps adjusting focus so that the area within the white focus frame stays sharp.

Single autofocus

The camera automatically focuses on the selected subject. Continuous autofocus is on.

Face detection

The camera automatically detects up to five human faces, indicated by frames on the screen. The camera automatically focuses on the nearest face. You can also select which face to focus on by tapping it on the screen. When you tap the camera screen, a yellow frame shows which face is selected and in focus. Face detection cannot be used for all scene types. Continuous autofocus is on.

Object tracking

When you select an object by touching it in the viewfinder, the camera tracks it for you.

- ! This setting is only available in **Manual** capturing mode.

Metering

This function automatically determines a well-balanced exposure by measuring the amount of light striking the image you want to capture.

Center

Adjusts the exposure to the centre of the image.

Average

Calculates the exposure based on the amount of light striking the whole image.

Spot

Adjusts the exposure in a very small part of the image that you want to capture.

- ! This setting is only available in **Manual** capturing mode.

Microphone

Select whether to pick up the surrounding sound when recording videos.

Flash

Use the flash light to record videos when lighting conditions are poor or when there is a backlight. The video flash icon  is only available on the video camera screen. Note that the video quality can sometimes be better without a light even if lighting conditions are poor.



On



Off

Album



Viewing photos and videos

Use the Pictures tab in the Album application to view photos and play videos that you've taken with your camera, or to view similar content that you've saved to your device. All photos and videos are displayed in a chronologically ordered grid.



- 1 View photos and videos in the Pictures tab
- 2 View photos and videos in the My albums tab
- 3 View menu options
- 4 The date of items in the group
- 5 Tap a photo or video to view it
- 6 Scroll up or down to view content

To view photos and videos

- 1 From your Home screen, tap .
 - 2 Find and tap **Album**.
 - 3 Tap a photo or video to view it.
 - 4 Flick left to view the next photo or video. Flick right to view the previous photo or video.
-  If the screen orientation does not change automatically when you turn your device sideways, mark the **Auto-rotate screen** checkbox under **Settings > Display**.

To change the size of the thumbnails

- When viewing thumbnails of photos and videos in Album, spread two fingers apart to zoom in, or pinch two fingers together to zoom out.



To zoom a photo

- When you are viewing a photo, spread two fingers apart to zoom in, or pinch two fingers together to zoom out.

To watch a slideshow of your photos

- 1 When you are viewing a photo, tap the screen to display the toolbars, then tap  > **Slideshow** to start playing all the photos in an album.
- 2 Tap a photo to end the slideshow.

To watch a slideshow of your photos with music

- 1 When you are viewing a photo, tap the screen to display the toolbars, then tap  > **SensMe™ slideshow**.
- 2 Select the music and theme that you want to use for the slideshow, then tap . The Album application analyses your photos and uses SensMe™ music data to play a slideshow.
- 3 To pause playing, tap the screen to display the controls, then tap .

To play a video

- 1 Open the **Pictures** tab or the **My albums** tab in Album.
- 2 Using grid view or list view, locate the video that you want to open.
- 3 Tap the video to play it.
- 4 If the playback controls are not displayed, tap the screen to display them. To hide the controls, tap the screen again.

To pause a video

- 1 When a video is playing, tap the screen to display the controls.
- 2 Tap .

To fast forward and rewind a video

- 1 When a video is playing, tap the screen to display the controls.
- 2 Drag the progress bar marker left to rewind, or right to fast forward.

To adjust the volume of a video

- Press the volume key.

Sharing and managing photos and videos

You can share photos and videos that you've stored on your device. You can also manage them in different ways. For example, you can work with photos in batches, delete photos and link them to contacts.

- ! You might not be able to copy, send or transfer copyright-protected items. Also, some items may not send if the file size is too large.

To share a photo or video

- 1 In Album, find and tap the photo or video that you want to share.
- 2 Tap the screen to display the toolbars, then tap .
- 3 Tap the application that you want to use to share the photo, then follow the steps to send it.

To use a photo as a contact picture

- 1 When you are viewing a photo, tap the screen to display the toolbars, then tap  > **Use as** > **Contact picture**.
- 2 If asked, select **Contacts** > **Just once**, then select a contact.

To use a photo as wallpaper

- 1 When you are viewing a photo, tap the screen to display the toolbars, then tap  > **Use as** > **Wallpaper**.
- 2 Follow the instructions on the screen.



To rotate a photo

- 1 When you are viewing a photo, tap the screen to display the toolbars, then tap .
- 2 Select **Rotate**. The photo is saved in the new orientation.

To delete a photo or video

- 1 When you are viewing a photo, tap the screen to display the toolbars, then tap .
- 2 Tap **Delete**.

To work with batches of photos or videos in Album

- 1 When viewing thumbnails of photos and videos in Album, tap , then tap **Select items**.
 - 2 Tap the items that you want to work with. Selected items are indicated by a blue frame.
 - 3 Use the tools in the toolbars to work with your selected items.
-  To activate selection mode, you can also touch and hold an item until its frame turns blue. Then you can tap other items to select them.

Analysing photos with faces in Album

You can analyse any photos on your device that feature people's faces. Once activated, the photo analysis feature stays on, and new photos get analysed as they are added. After running an analysis, you can then group all photos of the same person in one folder.

To turn on the photo analysis feature

- 1 From your Home screen, tap .
- 2 Find and tap **Album** > **My albums** > **Faces**.
- 3 All photos on your device get analysed and grouped in the Unnamed faces folder accordingly.

To name a face

- 1 In the **Faces** tile, tap the **Unnamed faces** folder, then browse to the **Other faces** folder and choose the face that you want to name.
- 2 Tap **Add name**.
- 3 Type a name, then tap **Done** > **Add as new person**.

To edit a face name

- 1 When you are viewing a face in full screen view, tap the screen to display the toolbars, then tap  > **Edit name tags**.
- 2 Tap **OK**.
- 3 Tap the name of the face that you want to edit.
- 4 Edit the name, then tap **Done** > **Add as new person**.



Editing photos with the Photo editor application

You can edit and apply effects to original photos that you've taken with your camera. For example, you can change the light effects. After you save the edited photo, the original unchanged version of the photo remains on your device.



To edit a photo

- When you are viewing a photo, tap the screen to display the toolbars, then tap .



To crop a photo

- 1 When you are viewing a photo, tap the screen to display the toolbars, then tap .
- 2 If prompted, select **Photo editor** > **Just once**.
- 3 Tap  > **Crop**.
- 4 Tap  to select an option.
- 5 To adjust the crop frame, touch and hold the edge of the crop frame. When the squares at the edges disappear, drag inward or outward to resize the frame.
- 6 To resize all sides of the crop frame at the same time, touch and hold one of the four corners to make the squares at the edges disappear, then drag the corner accordingly.
- 7 To move the crop frame to another area of the photo, touch and hold inside the frame, then drag it to the desired position.
- 8 Tap **Apply Crop**.
- 9 To save a copy of the photo as you cropped it, tap **Save**.



To apply special effects to a photo

- 1 When you are viewing a photo, tap the screen to display the toolbars, then tap .
- 2 If prompted, select **Photo editor > Just once**.
- 3 Tap , then select an option.
- 4 To save a copy of the edited photo, tap **Save**.

To improve a photo using advanced settings

- 1 When you are viewing a photo, tap the screen to display the toolbars, then tap .
- 2 If prompted, select **Photo editor > Just once**.
- 3 Tap , then select an option.
- 4 To save a copy of the edited photo, tap **Save**.

To adjust the light settings for a photo

- 1 When you are viewing a photo, tap the screen to display the toolbars, then tap .
- 2 If prompted, select **Photo editor > Just once**.
- 3 Tap , then select an option.
- 4 To save a copy of the edited photo, tap **Save**.

To set the saturation level of colours in a photo



- 1 When you are viewing a photo, tap the screen to display the toolbars, then tap .
- 2 If prompted, select **Photo editor > Just once**.
- 3 Tap , then select an option.
- 4 To save a copy of the edited photo, tap **Save**.

Photo albums

The My albums tab in the Album application gathers together all your photo albums, including albums of photos and videos taken with the camera as well as content that you share online via services such as PlayMemories, Picasa and Facebook. Once you are logged in to such services, you can manage content, comment on photos and videos, and view comments from friends. From the Album application, you can also add geotags to photos, perform basic editing tasks, and use methods such as Bluetooth® wireless technology, email, and messaging to share content.



- 1 View photos and videos using the PlayMemories online service
- 2 View photos and videos on Facebook™
- 3 View photos and videos in Picasa™
- 4 View photos using the Flickr™ online service
- 5 View all photos and videos taken with your device's camera

- 6 View all photos and videos saved to your device's internal storage
- 7 View your photos in globe mode
- 8 View your photos on a map
- 9 View all photos and videos saved to the removable memory card
- 10 View all photos with faces

! The PlayMemories online service is not available in all countries or regions.

To view photos from online services in Album

- 1 From your Home screen, tap .
- 2 Find and tap **Album** > **My albums**.
- 3 Tap the desired online service.
- 4 Tap **Connect**. All available online albums that you have uploaded to the service are displayed.
- 5 Tap any album to view its content, then tap a photo in the album.
- 6 Flick left to view the next photo or video. Flick right to view the previous photo or video.

To view and add comments to online album content

- 1 When viewing a photo from an online album, tap the screen to display the toolbars, then tap  to view the comments.
- 2 Enter your comments in the input field, then tap **Post**.

To "Like" a photo or video on Facebook™

- While viewing a photo or video from one of your Facebook™ albums, tap the screen to display the toolbars, then tap  to show that you "Like" the item on Facebook™.

Viewing your photos on a map

Adding location information to photos is referred to as geotagging. You can view and tag your photos on a map and show friends and family where you were when you took a particular photo. See *Adding the geographical position to your photos* on page 68 for more information.

- 💡 If you have turned on location detection and activated geotagging in the camera, you can tag your photos directly for map viewing at a later stage.

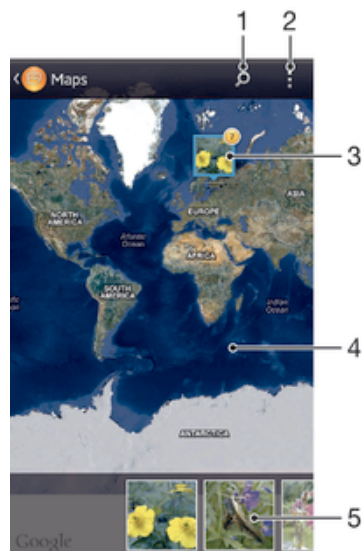

- 1 Search a location on the map.
- 2 View menu options.
- 3 A group of photos and/or videos geotagged with the same location.
- 4 Double tap to zoom in. Pinch to zoom out. Drag to view different parts of the map.
- 5 Thumbnails of the selected group of photos and/or videos. Tap an item to view it in full screen.

💡 If several photos were taken at the same location, only one of them appears on the map. The total number of photos appears in the top right corner, for example, . To view all photos in the group, tap the cover photo and then tap one of the thumbnails at the bottom of the screen.

To add a geotag to a photo

- 1 When you are viewing a photo, tap the screen to display the toolbars, then tap **Tap to set location** to open the map screen.
- 2 Find and tap the desired location to put the photo on the map.
- 3 To adjust the location of the photo, tap the location on the map to where you want to move the photo.
- 4 When you are finished, tap **OK** to save the geotag and return to the photo viewer.

To view geotagged photos on a map

- 1 From your Home screen, tap .
- 2 Find and tap **Album > My albums > Maps**.
- 3 Tap a photo to view it in full screen.

To view geotagged photos on a globe

- 1 From your Home screen, tap .
- 2 Find and tap **Album > My albums > Globe**.
- 3 Tap a photo to view it in full screen.

To change the geotag of a photo

- 1 When viewing a photo on the map in Album, touch and hold the photo until its frame turns blue, then tap the desired location on the map.
- 2 Tap **OK**.

To change the map view

- When viewing the map in Album, tap , then select **Classic view** or **Satellite view**.

Movies

Watching videos in the Movies application

Use the Movies application to play movies and other video content that you've saved or downloaded to your device. The Movies application also helps you get poster art, plot summaries, genre info and director details for each movie. You can also play your movies on other devices that are connected to the same network.

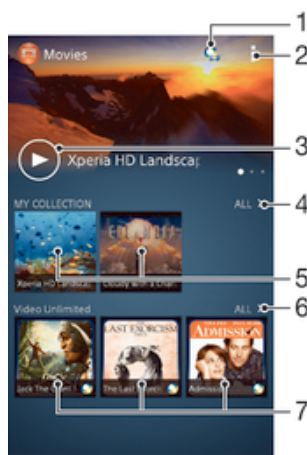

- ! Videos taken with your device's camera are displayed in the Album application, not in the Movies application.
- ! Some video files may not be playable in the Movies application.



- 1 Open the Video Unlimited application
- 2 View menu options
- 3 Tap to play your most recently watched video
- 4 Browse all videos downloaded or saved to your device
- 5 Tap to play saved or downloaded video files
- 6 Tap to view all videos in Video Unlimited
- 7 Tap to view details of a video in Video Unlimited

- ! Sony Entertainment Network with Video Unlimited and Music Unlimited is not available in every market. Separate subscription required. Additional terms and conditions apply.

To play a video in Movies

- 1 From your Home screen, tap , then find and tap **Movies**.
- 2 Find and tap the video that you want to play. If the video is not displayed on the screen, tap **All** in the **My Collection** tab, then find and tap the video that you want to play.
- 3 To display or hide the controls, tap the screen.
- 4 To pause playing, tap . To resume playing, tap .
- 5 To rewind, drag the progress bar marker to the left. To fast forward, drag the progress bar marker to the right.

To play a video on an external device

- 1 When the video is playing, tap the screen to display all the controls.
- 2 Tap  > **Throw**.
- 3 Select an external device on which to play the video. If there is no external device available, follow the on-screen instructions to add one.

To change settings in Movies

- 1 From your Home screen, tap , then find and tap **Movies**.
- 2 Tap , then change the settings as desired.

To change the sound settings while a video is playing

- 1 While a video is playing, tap the screen to display the controls.
- 2 Tap , then tap **Sound settings**.
- 3 Mark the checkboxes for the sound settings that you want to activate.
- 4 When you're finished, tap **OK**.

To share a video

- 1 When a video is playing, tap , then tap **Share**.
- 2 In the menu that opens, tap the application that you want to use to share the selected video, then follow the relevant steps to send it.

Transferring video content to your device

Before you start using the Movies application, it's a good idea to transfer movies, TV shows and other video content to your device from other devices, such as a computer. There are several ways to transfer your content:

- Connect your device to a computer using a USB cable and drag and drop the video files directly using the file manager application on the computer. See *Connecting your device to a computer* on page 94.
- If you have a PC, use the Media Go™ application from Sony™ to organise content and transfer video files to your device via the PC. To learn more and download the Media Go™ application, go to <http://mediago.sony.com/enu/features>.
- If your computer is an Apple® Mac®, you can use Sony™ Bridge for Mac to transfer video files from iTunes to your device. To learn more and download Sony™ Bridge for Mac, go to www.sonymobile.com/global-en/tools/bridge-for-mac/.

Managing video content

To get movie information manually

- 1 Make sure that your device has an active data connection.
 - 2 From your Home screen, tap , then find and tap **Movies**.
 - 3 Tap **All** in the **My Collection** tab to browse to the thumbnail of a file that you want to get information about.
 - 4 Touch and hold the thumbnail for the video, then tap **Search for info**.
 - 5 If prompted, allow your device to download video details using your mobile data connection.
 - 6 In the search field, enter keywords for the video, then tap the confirm key on the keyboard. All matches are displayed in a list.
 - 7 Select a search result, then tap **Done**. The download of the information begins.
- ! You can get information about newly added videos automatically every time the Movies application opens if you mark the **Get video details** checkbox under Settings. Data transmission charges may apply.

-  If the downloaded information is not correct, search again using different keywords.

To clear information about a video

- 1 From your Home screen, tap , then find and tap **Movies**.
- 2 Tap **All** in the **My Collection** tab to browse to the video that you want to edit.
- 3 Touch and hold the video thumbnail, then tap **Clear info**.

To delete a video

- 1 From your Home screen, tap , then find and tap **Movies**.
- 2 Tap **All** in the **My Collection** tab to browse to the video that you want to delete.
- 3 Touch and hold the video thumbnail, then tap **Delete** from the list that appears.
- 4 Tap **Delete** again to confirm.

Video Unlimited



Video Unlimited service

Use the Video Unlimited service to rent and buy movies or TV shows that you can view not only on your Android™ device, but also on a PC, PlayStation® Portable (PSP®), PlayStation® 3 or PlayStation® Vita. Select your pick from the latest Hollywood releases, action movies, comedies, classics, and a range of other categories.

You need to create a Video Unlimited account if you want to buy or rent movies through the Video Unlimited service. If you already have a PlayStation® network account or a Sony Entertainment Network account, then you can use that account instead.

- ! Sony Entertainment Network with Video Unlimited and Music Unlimited is not available in every market. Separate subscription required. Additional terms and conditions apply.

To get started with Video Unlimited



- 1 From your Home screen, tap .
- 2 Find and tap .
- 3 If you are starting Video Unlimited for the first time, tap **Continue** in the Welcome screen and enter your birth date if required, then tap **Continue** again to go to the main screen of Video Unlimited.
- 4 Tap  > **Sign In**, then follow the on-screen instructions to sign in to your account, or create a new account, to buy or rent movies.

Web browser

Browsing the web

The Google Chrome™ web browser for Android™ devices comes pre-installed in most markets. Go to <http://support.google.com/chrome> and click the "Chrome for Mobile" link to get more detailed information about how to use this web browser.

To browse with Google Chrome™

- 1 From your Home screen, tap .
- 2 Find and tap .
- 3 Enter a search term or web address in the search and address field, then tap **Go** on the keyboard.



- 1 Search and address field
- 2 Refresh the page
- 3 Access browser tabs
- 4 View help and options
- 5 Go back a page in the browser history

Connectivity

Connecting to wireless networks

You can access the Internet wirelessly from your device using Wi-Fi® technology. This way you can browse the web and share media files over the same Wi-Fi® network with other DLNA Certified™ devices, for example, TVs and computers.

If your company or organisation has a virtual private network (VPN), you can connect to this network using your device. You can use a VPN to access intranets and other internal services at your company.

Before using Wi-Fi®



To browse the Internet using a Wi-Fi® connection, you need to search for and connect to an available Wi-Fi® network and then open the Internet browser. The signal strength of the Wi-Fi® network may differ depending on your device's location. Move closer to the Wi-Fi® access point to increase the signal strength.

To turn on Wi-Fi®

- 1 From your Home screen, tap .
- 2 Find and tap **Settings**.
- 3 Drag the slider beside **Wi-Fi** to the right to turn on the Wi-Fi® function.

! It may take a few seconds before Wi-Fi® is enabled.

To connect to a Wi-Fi® network automatically

- 1 Make sure that the Wi-Fi® function is turned on.
- 2 Drag the status bar downwards, then tap .
- 3 Tap **Wi-Fi**. All available Wi-Fi® networks are displayed.
- 4 Tap a Wi-Fi® network to connect to it. For secured networks, enter the relevant password.  is displayed in the status bar once you are connected.

💡 Tap  and then tap **Scan** to search for new available networks.



To connect to another Wi-Fi® network

- 1 From your Home screen, tap .
- 2 Find and tap **Settings** > **Wi-Fi**. Detected Wi-Fi® networks are displayed.
- 3 Tap another Wi-Fi® network to connect to it.

To scan for Wi-Fi® networks manually

- 1 From your Home screen, tap .
- 2 Find and tap **Settings** > **Wi-Fi**.
- 3 Press , then tap **Scan**.
- 4 To connect to a Wi-Fi® network, tap the network name.

To add a Wi-Fi® network manually



- 1 Make sure that the Wi-Fi® function is turned on.
 - 2 Drag the status bar downwards, then tap .
 - 3 Tap **Wi-Fi**.
 - 4 Tap .
 - 5 Enter the **Network SSID** information.
 - 6 To select a security type, tap the **Security** field.
 - 7 If required, enter a password.
 - 8 Tap **Save**.
- ! Contact your Wi-Fi® network administrator to get the Network SSID and password.

Advanced Wi-Fi® settings

Wi-Fi® network status

When you are connected to a Wi-Fi® network or when there are Wi-Fi® networks available in your vicinity, it is possible to see the status of these Wi-Fi® networks. You can also enable your device to notify you whenever an open Wi-Fi® network is detected.

To enable Wi-Fi® network notifications

- 1 Turn on Wi-Fi®, if it is not already on.
- 2 From your Home screen, tap .
- 3 Find and tap **Settings** > **Wi-Fi**.
- 4 Press .
- 5 Tap **Advanced**.
- 6 Mark the **Network notification** checkbox.

To view detailed information about a connected Wi-Fi® network



- 1 From the Home screen, tap .
- 2 Find and tap **Settings** > **Wi-Fi**.
- 3 Tap the Wi-Fi® network that you are currently connected to. Detailed network information is displayed.

Wi-Fi® sleep policy

By adding a Wi-Fi® sleep policy, you can specify when to switch from Wi-Fi® to mobile data.

- ! If you are not connected to a Wi-Fi® network, your device uses a mobile data connection to access the Internet (if you have set up and enabled a mobile data connection on your device).



To add a Wi-Fi® sleep policy

- 1 From the Home screen, tap .
- 2 Find and tap **Settings** > **Wi-Fi**.
- 3 Press .
- 4 Tap **Advanced**.
- 5 Tap **Keep Wi-Fi on during sleep**.
- 6 Select an option.

Wi-Fi Direct™

Use Wi-Fi Direct™ to connect to other devices directly, without joining a traditional home, office or hotspot network. For example, you can enable your device to be connected directly to a computer so that you can access content from your device on the computer. The devices that you share content with must have Wi-Fi Direct™ certification.

To turn on Wi-Fi Direct™

- 1 Make sure your device has the Wi-Fi® function turned on.
- 2 From your Home screen, tap .
- 3 Find and tap **Settings** > **Wi-Fi**.
- 4 Tap  > **Wi-Fi Direct**.



Sharing your mobile data connection

You can share your device's mobile data connection with a single computer using a USB cable. This process is called USB tethering. You can also share your device's data connection with up to eight other devices at once by turning your device into a portable Wi-Fi® hotspot. When your device's mobile data connection is successfully

shared, the sharing devices can use your device's data connection, for example, to surf the Internet, download applications, or send and receive emails.



- 💡 You may need to prepare your computer to establish a network connection via USB cable. Go to www.android.com/tether to get the most current information.

To share your data connection using a USB cable

- 1 Deactivate all USB cable connections to your device.
- 2 Using the USB cable that came with your device, connect your device to a computer.
- 3 From your Home screen, tap .
- 4 Find and tap **Settings** > **More...** > **Tethering & portable hotspot**.
- 5 Mark the **USB tethering** checkbox, then tap **OK** if prompted.  is displayed in the status bar once you are connected.
- 6 To stop sharing your data connection, unmark the **USB tethering** checkbox or disconnect the USB cable.

- ! You cannot share your device's data connection and SD card over a USB cable at the same time.

To use your device as a portable Wi-Fi® hotspot

- 1 From your Home screen, tap .
- 2 Find and tap **Settings** > **More...** > **Tethering & portable hotspot**.
- 3 Tap **Portable Wi-Fi hotspot settings** > **Configure Wi-Fi hotspot**.
- 4 Enter the **Network SSID** information.
- 5 To select a security type, tap the **Security** field. If required, enter a password.
- 6 Tap **Save**.
- 7 Tap  and mark the **Portable Wi-Fi hotspot** checkbox.
- 8 If prompted, tap **OK** to confirm.  appears in the status bar once the portable Wi-Fi® hotspot is active.
- 9 To stop sharing your data connection via Wi-Fi®, unmark the **Portable Wi-Fi hotspot** checkbox.

To rename or secure your portable hotspot

- 1 From the Home screen, tap .
- 2 Find and tap **Settings** > **More...** > **Tethering & portable hotspot**.
- 3 Tap **Portable Wi-Fi hotspot settings** > **Configure Wi-Fi hotspot**.
- 4 Enter the **Network SSID** for the network.
- 5 To select a security type, tap the **Security** field.
- 6 If required, enter a password.
- 7 Tap **Save**.

Virtual private networks (VPNs)

Use your device to connect to virtual private networks (VPNs), which allow you to access resources inside a secured local network from a public network. For example, VPN connections are commonly used by corporations and educational institutions for users who need to access intranets and other internal services when they are outside of the internal network, for example, when they are travelling.

VPN connections can be set up in many ways, depending on the network. Some networks may require you to transfer and install a security certificate on your device. For detailed information on how to set up a connection to your virtual private network, please contact the network administrator of your company or organisation.

To add a virtual private network

- 1 From your Home screen, tap .
- 2 Find and tap **Settings** > **More...** > **VPN**.
- 3 Tap **+**.
- 4 Select the type of VPN to add.
- 5 Enter your VPN settings.
- 6 Tap **Save**.

To connect to a virtual private network

- 1 From your Home screen, tap .
- 2 Find and tap **Settings** > **More...** > **VPN**.
- 3 In the list of available networks, tap the VPN that you want to connect to.
- 4 Enter the required information.
- 5 Tap **Connect**.

To disconnect from a virtual private network

- 1 Drag the status bar downwards.
- 2 Tap the notification for the VPN connection to turn it off.

Sharing content with DLNA Certified™ devices

You can view or play media content saved to your device on other devices such as, for example, a TV, or a computer. Such devices must be DLNA Certified™ by the Digital Living Network Alliance and all devices must be connected to the same Wi-Fi® network in order for content to be shared. You can also view or play content from other DLNA Certified™ devices on your device.

After you set up the sharing of content between devices, you can, for example, listen to music files stored on your home computer from your device, or view photos taken with your device's camera on a large-screen TV.

Playing files from DLNA Certified™ devices on your device

When you play files from another DLNA Certified™ device on your device, this other device acts as a server. In other words, it shares content over a network. The server device must have its content sharing function enabled and give access permission to your device. It also must be connected to the same Wi-Fi® network as your device.

To play a shared track on your device

- 1 Make sure the devices that you want to share files with are connected to the same Wi-Fi® network as your device.
- 2 From your Home screen, tap , then find and tap **WALKMAN**.
- 3 Select a device from the list of connected devices.
- 4 Browse the folders of the connected device and select the track that you want to play. The track starts playing automatically.

To play a shared video on your device

- 1 Make sure the devices that you want to share files with are connected to the same Wi-Fi® network as your device.
- 2 From your Home screen, tap , then find and tap **Movies**.
- 3 Select a device from the list of connected devices.
- 4 Browse the folders of the connected device and select the video that you want to play.

To view a shared photo on your device





- 1 Make sure the devices that you want to share files with are connected to the same Wi-Fi® network as your device.
- 2 From your Home screen, tap .
- 3 Find and tap **Album** > **My albums**. All your available online albums and connected devices are displayed.
- 4 Select a device from the list of connected devices.
- 5 Browse the folders of the connected device and select a photo to view it.

Preparing to play content from your device on DLNA Certified™ devices



Before you can view or play media files from your device on other DLNA Certified™ devices, you must set up file sharing on your device. The devices that you share content with are called client devices. For example, a TV, computer or tablet can act as client devices. Your device works as a media server when it makes content

available to client devices. When you set up file sharing on your device, you must also give access permission to client devices. After you do so, such devices appear as registered devices. Devices that are waiting for access permission are listed as pending devices.



To set up file sharing using the Connected devices feature[MR2]

- 1 Connect your device to a Wi-Fi® network.
 - 2 From your Home screen, tap , then find and tap .
 - 3 Tap , then tap **Media server**.
 - 4 To turn on the **Share media** function, drag the slider.  appears in the status bar. Your device can now work as a media server.
 - 5 Connect your computer or other devices to the same Wi-Fi® network as your device.
 - 6 A notification appears in the status bar of your device. Open the notification and set the relevant access permissions for other devices.
- ! The instructions described above may differ depending on the client devices used. Refer to your client device User guide for more information. If the device cannot connect, check that your Wi-Fi® network is working.
- 💡 You can also access the **Media server** menu under **Settings > Xperia™ > Media server settings**. If you close the **Media server** view, the file sharing function stays running in the background.



To stop sharing files with other DLNA Certified™ devices

- 1 From your Home screen, tap , then find and tap .
- 2 Tap , then tap **Media server**.
- 3 Drag the slider to turn off the **Share media** function.



To set access permissions for a pending device

- 1 From your Home screen, tap , then find and tap .
- 2 Tap , then tap **Media server**.
- 3 Select a device from the **Pending devices** list.
- 4 Select an access permission level.





To change the name of a registered device

- 1 From your Home screen, tap , then find and tap .
- 2 Tap , then tap **Media server**.
- 3 Select a device from the **Registered devices** list, then select **Change name**.
- 4 Enter a new name for the device.

To change the access level of a registered device

- 1 From your Home screen, tap , then find and tap .
- 2 Tap , then tap **Media server**.
- 3 Select a device from the **Registered devices** list.
- 4 Tap **Change access level** and select an option.

To get help about sharing content with other DLNA Certified™ devices

- 1 From your Home screen, tap , then find and tap .
- 2 Tap , then tap **Media server**.
- 3 Tap .





Playing files on a Digital Media Renderer device

Using DLNA™ technology, you can push media content saved on your device to another device connected to the same Wi-Fi® network. The other device must be able to function as a Digital Media Renderer (DMR) device, which means that it can



render, or play, content received from your device. A DMR device can be, for example, a TV with DLNA function, or a PC running Windows® 7 or higher.

- ! The settings for enabling the Digital Media Renderer may vary depending on the device used. Refer to the user guide for the respective device for more detailed information.
- ! Content with Digital Rights Management (DRM) cannot be played on a Digital Media Renderer device using DLNA™ technology.

To view photos or videos from your device on a DMR device

- 1 Make sure that you have correctly set up the DMR device and that it is connected to the same Wi-Fi® network as your device.
 - 2 From your Home screen, tap .
 - 3 Find and tap **Album**.
 - 4 Browse to and open the file that you want to view.
 - 5 Tap the screen to display the toolbars, then tap  and select a DMR device to share your content with. The selected files start playing in chronological order on the device that you select.
 - 6 To disconnect from the DMR device, tap  and select your device. The file stops playing on the DMR device but continues playing on your device.
-  You can also share a video from the Movies application on your device by tapping the video and then tapping .

To play a music track from your device on a DMR device

- 1 Make sure that you have correctly set up the DMR device and that it is connected to the same Wi-Fi® network as your device.
- 2 From your Home screen, tap , then find and tap **WALKMAN**.
- 3 Select a music category and browse to the track that you want to share, then tap the track.
- 4 Tap  and select a DMR device to share your content with. The track plays automatically on the device that you select.
- 5 To disconnect from the DMR device, tap  and select your device. The track stops playing on the DMR device but continues playing on your device.

NFC

Use Near Field Communications (NFC) to share data with other devices, such as a video, photo, web page address, music file or contact. You can also use NFC to scan tags that give you more information about a product or service as well as tags that activate certain functions on your device.

NFC is a wireless technology with a maximum range of one centimetre, so the devices sharing data must be held close to each other. Before you can use NFC, you must first turn on the NFC function, and the screen of your device must be active.

- ! NFC may not be available in all countries and/or regions.

To turn on the NFC function

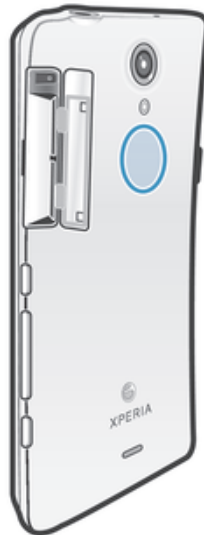

- 1 From your Home screen, tap .
- 2 Find and tap **Settings > More....**
- 3 Mark the **NFC** checkbox.

NFC detection area





- ! The location of the NFC detection area is not the same on all devices. When sharing data with another device using NFC, refer to the User guide of the other device for more information.

To share a contact with another device using NFC



- 1 Make sure that both devices have the NFC function turned on, and that both screens are active.
- 2 To view contacts, go to your Home screen, tap , then tap .
- 3 Tap the contact that you want to share.
- 4 Hold your device and the receiving device back to back so that the NFC detection areas of each device touch each other. When the devices connect, they vibrate and play a short sound. A thumbnail of the contact appears.
- 5 Tap the thumbnail to start the transfer.
- 6 When the transfer is done, the contact information is displayed on the screen of the receiving device and is also saved on the receiving device.

To share a music file with another device using NFC



- 1 Make sure that both your device and the receiving device have the NFC function turned on, and that both screens are active.
- 2 To open the "WALKMAN™" application, tap , then find and tap .
- 3 Select a music category and browse to the track you want to share.
- 4 Tap the track to play it. You can then tap  to pause the track. The transfer works whether the track is playing or paused.
- 5 Hold your device and the receiving device back to back so that the NFC detection areas of each device touch each other. When the devices connect, they vibrate and play a short sound. A thumbnail of the track appears.
- 6 Tap the thumbnail to start the transfer.
- 7 When the transfer is done, the music file plays immediately on the receiving device. At the same time, the file is saved on the receiving device.

- ! You might not be able to copy, send or transfer copyright-protected items.

To share a photo or video with another device using NFC

- 1 Make sure that both devices have the NFC function turned on, and that both screens are active.
 - 2 To view photos and videos in your device, go to your Home screen, tap , then find and tap **Album**.
 - 3 Tap the photo or video that you want to share.
 - 4 Hold your device and the receiving device back to back so that the NFC detection areas touch each other. When the devices connect, they vibrate and play a short sound. A thumbnail of the photo or video appears.
 - 5 Tap the thumbnail to start the transfer.
 - 6 When the transfer is done, the photo or video is displayed on the screen of the receiving device. At the same time, the item is saved on the receiving device.
-  You can also use NFC to share a video from the Movies application.

To share a web address with another device using NFC

- 1 Make sure that both devices have the NFC function turned on, and that both screens are active.
- 2 From your Home screen, tap .
- 3 To open the web browser, find and tap .
- 4 Load the web page that you want to share.
- 5 Hold your device and the receiving device back to back so that the NFC detection areas touch each other. When the devices connect, they vibrate and play a short sound. A thumbnail of the web page appears.
- 6 Tap the thumbnail to start the transfer.
- 7 When the transfer is done, the web page is displayed on the screen of the receiving device.

Scanning NFC tags

Your device can scan various kinds of NFC tags. For example, it can scan embedded tags on a poster, on a billboard advertisement, or beside a product in a retail store. You can receive additional information, such as a web address.

To scan an NFC tag

- 1 Make sure that your device has the NFC function turned on and that the screen is active.
- 2 Place your device over the tag so that the NFC detection area touches it. Your device scans the tag and displays the content collected. Tap the content of the tag to open it.
- 3 To open the tag, tap it.

Connecting to an NFC compatible device

You can connect your device to other NFC compatible devices produced by Sony, such as a speaker or a headphone. When establishing this kind of connection, refer to the User guide of the compatible device for more information.

-  You may need to have Wi-Fi® or Bluetooth® activated on both devices for the connection to work.

Bluetooth® wireless technology

Use the Bluetooth® function to send files to other Bluetooth® compatible devices, or to connect to handsfree accessories. Turn on the Bluetooth® function in your device and create wireless connections to other Bluetooth® compatible devices such as computers, handsfree accessories, and phones. Bluetooth® connections work better within 10 metres (33 feet), with no solid objects in between. In some cases you have to manually pair your device with other Bluetooth® devices.

-  Interoperability and compatibility among Bluetooth® devices can vary.

To turn on the Bluetooth® function and make your device visible

- 1 Drag the status bar downwards, then tap ✕.
- 2 Tap the on-off switch beside **Bluetooth** to turn on the Bluetooth® function.
- 3 Tap **Bluetooth**. Your device and a list of available Bluetooth® devices appear.
- 4 Tap your device name to make your device visible to other Bluetooth® devices.

To adjust your device's visibility time to other Bluetooth® devices

- 1 Drag the status bar downwards, then tap ✕.
- 2 Find and tap **Bluetooth**.
- 3 Press  and select **Visibility timeout**.
- 4 Select an option.

Naming your device

You can give your device a name. This name is shown to other devices after you have turned on the Bluetooth® function and your device is set to visible.

To give your device a name

- 1 Make sure that the Bluetooth® function is turned on.
- 2 Drag the status bar downwards, then tap ✕.
- 3 Find and tap **Bluetooth**.
- 4 Tap  and select **Rename phone**.
- 5 Enter a name for your device.
- 6 Tap **Rename**.

Pairing with another Bluetooth® device

When you pair your device with another device, you can, for example, connect your device to a Bluetooth® headset or a Bluetooth® car kit and use these other devices to share music.

Once you pair your device with another Bluetooth® device, your device remembers this pairing. When pairing your device with a Bluetooth® device, you may need to enter a passcode. Your device will automatically try the generic passcode 0000. If this does not work, refer to the user guide for your Bluetooth® device to get the device passcode. You do not need to re-enter the passcode the next time you connect to a previously paired Bluetooth® device.

- ! Some Bluetooth® devices, for example, most Bluetooth® headsets, require you to both pair and connect with the other device.
- ! You can pair your device with several Bluetooth® devices, but you can only connect to one Bluetooth® profile at the same time.

To pair your device with another Bluetooth® device

- 1 Make sure that the device you want to pair your device with has the Bluetooth® function activated and is visible to other Bluetooth® devices.
- 2 Drag the status bar downwards, then tap ✕.
- 3 Find and tap **Bluetooth**. All available Bluetooth® devices appear in a list.
- 4 Tap the Bluetooth® device that you want to pair with your device.
- 5 Enter a passcode, if required, or confirm the same passcode on both devices. Your device and the Bluetooth® device are now paired.

To connect your device to another Bluetooth® device

- 1 If you are connecting to a Bluetooth® device that requires you to first pair your device before connecting, follow the relevant steps to pair your device with that device.
- 2 Drag the status bar downwards, then tap ✕.
- 3 Find and tap **Bluetooth**.
- 4 Tap the Bluetooth® device to which you want to connect your device.

To unpair a Bluetooth® device

- 1 Drag the status bar downwards, then tap ✕.
- 2 Find and tap **Bluetooth**.
- 3 Under **Paired devices**, tap ✕ beside the name of the device that you want to unpair.
- 4 Tap **Unpair**.

Sending and receiving items using Bluetooth® technology

Share items with other Bluetooth® compatible devices such as phones or computers. You can send and receive several kinds of items using the Bluetooth® function, such as:

- Photos and videos
- Music and other audio files
- Contacts
- Web pages

To send items using Bluetooth®

- 1 **Receiving device:** Make sure the Bluetooth® function is turned on and that the device is visible to other Bluetooth® devices.
- 2 **Sending device:** Open the application which contains the item that you want to send, and scroll to the item.
- 3 Depending on the application and on the item that you want to send, you may need to, for example, touch and hold the item, open the item, and press ↵. Other ways to send an item may exist.
- 4 Select **Bluetooth**.
- 5 Turn on Bluetooth® if you are asked to do so.
- 6 Tap the name of the receiving device.
- 7 **Receiving device:** If asked, accept the connection.
- 8 **Sending device:** If asked, confirm the transfer to the receiving device.
- 9 **Receiving device:** Accept the incoming item.

To receive items using Bluetooth®

- 1 Make sure that the Bluetooth® function is on and is visible to other Bluetooth® devices.
- 2 The sending device now starts sending data to your device.
- 3 If prompted, enter the same passcode on both devices, or confirm the suggested passcode.
- 4 When you are notified of an incoming file to your device, drag the status bar downwards and tap the notification to accept the file transfer.
- 5 Tap **Accept** to start the file transfer.
- 6 To view the progress of the transfer, drag the status bar downwards.
- 7 To open a received item, drag the status bar downwards and tap the relevant notification.

To view files you have received using Bluetooth®

- 1 Drag the status bar downwards, then tap ✕.
- 2 Find and tap **Bluetooth**.
- 3 Press ≡ and select **Show received files**.

Connecting your device to a computer

Connect your device to a computer and start transferring pictures, music and other types of files. The easiest ways to connect are using a USB cable or Bluetooth® wireless technology.

When you connect your device to the computer using a USB cable, you are prompted to install software on the computer, for example, the PC Companion application on a PC or the Sony™ Bridge for Mac application on an Apple® Mac® computer. PC Companion and Sony™ Bridge for Mac help you access additional computer applications to transfer and organise media files, update your device, synchronise device content, and more.

- ! You might not be able to transfer some copyright-protected material between your device and a computer.

Transferring and handling content using a USB cable

Use a USB cable connection between a computer and your device for easy transfer and management of your files. Once the two devices are connected, you can drag and drop content between your device and the computer, or between your device's internal storage and SD card, using the computer's file explorer.

If you're transferring music, video, pictures or other media files to your device, it's best to use the Media Go™ application on your computer. Media Go™ converts media files so that you can use them on your device.

To transfer content between your device and computer using a USB cable

- 1 Using a USB cable, connect your device to a computer. **Internal storage & SD card connected** appears in the status bar on the screen of your device.
- 2 **Computer:** Open Microsoft® Windows® Explorer from the desktop and wait until your device's internal storage and your SD card appear as external disks in Microsoft® Windows® Explorer.
- 3 **Computer:** Drag and drop the desired files between your device and the computer.

To transfer content between internal storage and an SD card via USB

- 1 Using a USB cable, connect your device to a computer. **Internal storage & SD card connected** appears in the status bar on the screen of your device.
- 2 **Computer:** Open Microsoft® Windows® Explorer from the desktop and wait until your device's internal storage and your SD card appear as external disks in Microsoft® Windows® Explorer.
- 3 **Computer:** Drag and drop the desired files between the device's internal storage and the SD card.

To transfer files directly from internal storage to an SD card in the device

- 1 From your Home screen, tap .
- 2 Find and tap **Settings** > **Storage** > **Transfer data to SD card**.
- 3 Mark the file types you want to transfer to the SD card.
- 4 Tap **Transfer**.

- 💡 The direct transfer method means that a USB cable connection to a computer is not necessary.

Transferring files using Media transfer mode via Wi-Fi®

You can transfer files between your device and other MTP compatible devices, such as a computer, using a Wi-Fi® connection. Before connecting, you first need to pair the two devices. If you're transferring music, video, pictures or other media files between your device and a computer, it's best to use the Media Go™ application on

the computer. Media Go™ converts media files so that you can use them on your device.

- 💡 In order to use this feature, you need a Wi-Fi® enabled device that supports Media transfer, for example, a computer running Microsoft® Windows Vista® or Windows® 7.

To pair your device wirelessly with a computer using Media transfer mode

- 1 Make sure Media transfer mode is enabled on your device. It is normally enabled by default.
- 2 Connect your device to the computer using a USB cable.
- 3 **Computer:** Once the name of your device appears on the screen, click *Network configuration* and follow the instructions to pair the computer.
- 4 When you are finished pairing, disconnect the USB cable from both devices.

- ! The above instructions only work if Windows® 7 is installed on your computer and the computer is connected to a Wi-Fi® Access Point via a network cable.

To connect paired devices wirelessly in Media transfer mode[MR2]

- 1 Make sure Media transfer mode is enabled on your device. It is normally enabled by default.
- 2 Drag the status bar downwards, then tap ✕.
- 3 Tap **Xperia™ > USB Connectivity**.
- 4 Tap the paired device that you want to connect to under **Trusted devices**.
- 5 Tap **Connect**.

- ! Make sure the Wi-Fi® function is turned on.

To disconnect from connected device [MR2]

- 1 Drag the status bar downwards, then tap ✕.
- 2 Tap **Settings > Xperia™ > USB Connectivity**.
- 3 Tap the paired device that you want to disconnect from under **Trusted devices**.
- 4 Tap **Disconnect**.

To remove from the paired host [MR2]

- 1 Drag the status bar downwards, then tap ✕.
- 2 Tap **Settings > Xperia™ > USB Connectivity**.
- 3 Tap the paired device that you want to remove.
- 4 Tap **Forget**.

PC Companion

PC Companion is a computer application that gives you access to additional features and services which help you transfer music, video and pictures to and from your device. You can also use PC Companion to update your device and get the latest software version available. The installation files for PC Companion are saved on your device and the installation is launched from the device when you connect it to a computer via USB cable.

You need an internet connected computer running one of the following operating systems to use the PC Companion application:

- Microsoft® Windows® 7
- Microsoft® Windows® 8
- Microsoft® Windows Vista®
- Microsoft® Windows® XP (Service Pack 3 or higher)

To install PC Companion [MR2]

- 1 Make sure the **Install software** checkbox under **Settings > Xperia™ > USB Connectivity** is marked.
- 2 Connect your device to a PC using a USB cable.
- 3 **Device:** Tap **Install**.
- 4 **Computer:** The PC Companion installer starts automatically after a few seconds. Follow the on-screen instructions to install PC Companion.

To start PC Companion

- 1 Make sure that PC Companion is installed on your PC.
- 2 Open the PC Companion application on the PC, then click **Start** to open one of the features that you want to use.

Media Go™

The Media Go™ computer application helps you transfer and manage media content in your device and computer. You can install and access Media Go™ from within the PC Companion application.

You need one of these operating systems to use the Media Go™ application:

- Microsoft® Windows® 7
- Microsoft® Windows Vista®
- Microsoft® Windows® XP, Service Pack 3 or higher

To transfer content using the Media Go™ application

- 1 Connect your device to a computer using a supported USB cable.
- 2 **Device:** In the status bar, **Internal storage connected** appears.
- 3 **Computer:** Open the PC Companion application on the PC first. In PC Companion, click *Media Go* to start the Media Go™ application. In some cases, you may have to wait for Media Go™ to install.
- 4 Using Media Go™, drag and drop files between your computer and device.

Sony™ Bridge for Mac

The Sony™ Bridge for Mac application helps you transfer music, video, picture or other kinds of media files between your device and an Apple® Mac® computer. You can also use the Sony™ Bridge for Mac application to manage files through a file browser, update your device software, and back up and restore content on your device.

To use the Sony™ Bridge for Mac application, you must have an Internet-connected Apple® Mac® computer that runs MacOS version 10.6 or later.

To install Sony™ Bridge for Mac on an Apple® Mac® computer

- 1 Make sure the **Install software** checkbox under **Settings > Xperia™ Connectivity > USB Connectivity** is marked.
- 2 Connect your device to an Apple® Mac® computer using a USB cable.
- 3 **Device:** Tap **Install**.
- 4 **Computer:** The Sony™ Bridge for Mac installer starts automatically after a few seconds. Follow the on-screen instructions to complete the installation.

To open the Sony™ Bridge for Mac application

- 1 Make sure that the Sony™ Bridge for Mac application is installed on the Apple® Mac® computer.
- 2 **Computer:** Double-click the Sony™ Bridge for Mac application icon in the Applications folder.

To transfer content using Sony™ Bridge for Mac

- 1 Using a USB cable, connect your device to an Apple® Mac® computer.
- 2 **Computer:** Open the Sony™ Bridge for Mac application. After a few moments, The Sony™ Bridge for Mac application detects your device.
- 3 **Computer:** Drag and drop the desired files between your device and the Apple® Mac® computer.

Connecting your device to a TV set using a cable

Connect your device to a TV set and start viewing content saved in your device on a larger screen. When you connect your device to the TV set, the TV launcher application opens. This application helps you to play media files from your device on TVs and other devices.

- 💡 You may have to purchase an MHL cable separately.

To view content from your device on a TV which supports MHL input

- 1 Connect your device to the TV using an MHL cable.  appears in your device's status bar after a connection is established.
- 2 The **TV launcher** application starts automatically. Follow the instructions to view your media files on the TV.

To view content from your device on a TV which supports HDMI™ input

- 1 Connect your device to an MHL adaptor, and connect the adaptor to a USB power supply.
- 2 Connect the adaptor to a TV using a HDMI™ cable.  appears in your device's status bar after a connection is established.
- 3 The **TV launcher** application starts automatically. Follow the instructions to view your media files on the TV.

To view help about using the TV remote control

- 1 While your device is connected to the TV set, drag the status bar downwards to open the Notification panel.
- 2 Tap **MHL connected**.

- 💡 You can also press the yellow button on the TV remote control to open the Notification panel.

To disconnect your device from the TV set

- Disconnect the MHL™ cable or the MHL adaptor from your device.

Screen mirroring

Use Screen mirroring to show the screen of your device on a TV or other large display without using a cable connection. Wi-Fi Direct™ technology creates a wireless connection between the two devices, so you can sit back and enjoy your favourite photos from the comfort of your couch. You can also use this feature to listen to music from your device via the TV's speakers.

- ! Your TV must support screen mirroring based on Wi-Fi CERTIFIED Miracast™ for the functionality described above to work. If your TV does not support screen mirroring, you need to purchase a wireless display adapter separately.
- ! When using screen mirroring, the image quality may sometimes be negatively impacted if there is interference from other Wi-Fi® networks.

To mirror the screen of your device on a TV screen

- 1 **TV:** Follow the instructions in the User guide for your TV to turn on the screen mirroring function.
 - 2 **Your device:** Drag the status bar downwards, then tap .
 - 3 Find and tap **Xperia™ Connectivity > Screen mirroring**.
 - 4 Tap **Turn on Screen mirroring** and select a device.
- ! When using screen mirroring, do not cover the Wi-Fi antenna area of your device.

Scanning barcodes with the NeoReader™ application

About scanning with the NeoReader™ application

Use your device as a barcode scanner to find out more about items you scan. For example, you see a coat in a magazine ad and want to find the nearest retail outlet to buy it. If the ad contains a readable barcode, the NeoReader™ application uses this code to access mobile web content, such as a web page with more product information or a map of nearby outlets. NeoReader™ supports most standard barcode types.

To start the NeoReader™ application

- 1 From the Home screen, tap .
- 2 Find and tap  **NeoReader™**.

To scan a barcode







- 1 When the NeoReader™ application is open, hold your device over the barcode until the complete barcode is visible in the viewfinder.
- 2 Your device automatically scans the barcode, and vibrates when the barcode is recognised.

To enter a barcode manually

- 1 When the NeoReader™ application is open, tap .
- 2 Enter the numbers of the barcode in the text field, then tap **GO!**.

NeoReader™ application menu overview

The following menu options are available in the NeoReader™ application:

-  Tap to open more options
-  Enter the barcode numbers manually. This option can be used if your camera has difficulty reading the barcode
-  View a list of previously scanned barcodes
-  View information about the NeoReader™ application. Read more about different barcode types, and about how to use NeoReader™
-  Select your personal settings, such as language or country. This information is used to personalise barcode content. Also, you can select preferences for how you use the NeoReader™ application
-  Send a text message to invite a friend to download the NeoReader™ application

Smart Connect

Use the Smart Connect application to set what happens in your device when you connect or disconnect an accessory. You can also use Smart Connect to set a specific action or a group of actions to launch on your device at certain times of the day.

For example, when you connect your headset, you can create an event so that the following actions are launched on your device:

- Between 7am and 9am, when you commute to work, the "WALKMAN" application starts, and the web browser opens the morning paper. The ring volume is set to vibrate.
- On the way back from work, the FM radio starts, and a notes app opens showing your shopping list.

To start the Smart Connect application

- 1 From your Home screen, tap .
- 2 Find and tap .

To create a Smart Connect event

- 1 Start the Smart Connection application. If you are opening Smart Connect for the first time, tap **OK** to close the introduction screen.
- 2 On the **Events** tab, tap **+**.
- 3 Give the event a name, then tap **Create**.
- 4 Under **When**, add either an accessory or a time interval, or both.
- 5 Under **Do this**, add what you want to happen in your device.
- 6 Under **At the end**, add what you want to happen when you disconnect the accessory or when the time interval comes to an end. If both these conditions are set, the actions start either when you disconnect the accessory, or when the time interval comes to an end.
- 7 To save the event, press .

- 💡 To add a Bluetooth® accessory, you have to first pair it with your device.

To edit a Smart Connect event

- 1 Start the Smart Connection application.
- 2 On the **Events** tab, tap an event.
- 3 If the event is switched off, drag the slider to the right.
- 4 Adjust the settings as desired.

- 💡 To remove an event, tap the event's row, then tap  > **Delete event** and tap **Delete** to confirm.

Managing devices

Use the Smart Connect application to manage a range of smart accessories that you can connect to your device, including SmartTags, SmartWatch and Smart Wireless Headset pro from Sony. Smart Connect downloads any necessary applications and also finds third-party applications, when available. Previously connected devices show in a list that allows you to get more information about the features of each device.

To pair and connect an accessory

- 1 Start the Smart Connection application. If you are opening Smart Connect for the first time, tap **OK** to close the introduction screen.
- 2 Tap **Devices**, then tap **+**.
- 3 Tap **OK** to start searching for devices.
- 4 In the search result list, tap the name of the device that you want to add.

To adjust the settings for a connected accessory

- 1 Pair and connect the accessory with your device.
- 2 Start the Smart Connection application.
- 3 Tap **Devices**, then tap the name of the connected accessory.
- 4 Adjust the desired settings.

Synchronising data on your device

About synchronising data on your device

You can sync contacts, email, calendar events, and other information with your device from multiple email accounts, synchronisation services and other kinds of accounts, depending on the applications installed on your device. Synchronising your device with other information sources is an easy and practical way to stay up to date. You can synchronise data automatically by activating the auto-sync function.

To active the auto-sync function

- 1 Drag the status bar downwards, then tap ✕.
- 2 Drag the slider beside **Auto-sync** to the right.

Synchronising with Google™ services

Synchronise your device with different Google™ services to keep your information up to date, regardless of which device you're using your Google™ account from. For example, you can synchronise your contacts, Gmail™ and calendar data.

To set up a Google™ account for synchronisation

- 1 From your Home screen, tap ☰.
- 2 Tap **Settings > Add account > Google**.
- 3 Follow the registration wizard to create a Google™ account, or sign in if you already have an account.
- 4 Tap your newly created Google™ account, then tap the items that you want to synchronise.

To synchronise manually with your Google™ account

- 1 From the Home screen, tap ☰.
- 2 Tap **Settings > Google**.
- 3 Tap the Google™ account that you want to synchronise.
- 4 Press ⌵, then tap **Sync now**.

To synchronise an application with a Google™ account

- 1 From your Home screen, tap ☰.
- 2 Tap **Settings > Google**.
- 3 Tap the Google™ account that you want to synchronise with. A list appears of applications that can be synchronised with the Google account.
- 4 Tap the application that you want to synchronise with the selected Google account.

To synchronise the web browser data

- 1 From your Home screen, tap ☰.
- 2 Tap **Settings > Google**.
- 3 Tap the Google™ account that you want to synchronise with, then tap **Sync Browser**.

To remove a Google™ account

- 1 From your Home screen, tap ☰.
- 2 Tap **Settings > Google**.
- 3 Tap the Google™ account that you want to remove from the accounts list.
- 4 Press ⌵, then tap **Remove account**.
- 5 Tap **Remove account** again to confirm.

Synchronising with Microsoft® Exchange ActiveSync®



Using a Microsoft Exchange ActiveSync account, you can access your corporate email messages, calendar appointments and contacts directly on your device. After

setup, you can find your information in the **Email**, **Calendar** and **Contacts** applications.



To set up corporate email, calendar and contacts for synchronisation

- 1 From your Home screen, tap .
- 2 Tap **Settings** > **Add account** > **Exchange ActiveSync**.
- 3 Enter your corporate email address and password.
- 4 Tap **Next**. Your device begins to retrieve your account information. If a failure occurs, contact your corporate network administrator for more information, then enter the domain and server details for your account manually.
- 5 Tap **OK** to allow your corporate server to control your device.
- 6 Select what data you want to sync with your device, such as contacts and calendar entries.
- 7 If desired, activate the device administrator to allow your corporate server to control certain security features on your device. For example, you can allow your corporate server to set password rules and set storage encryption.
- 8 When the setup is done, enter a name for the corporate account.



To edit the setup of corporate email, calendar and contacts

- 1 From your Home screen, tap .
- 2 Tap **Email**, then tap .
- 3 Tap **Settings** and select a corporate account.
- 4 Change the desired settings.

To set a synchronisation interval for a corporate account

- 1 From your Home screen, tap .
- 2 Tap **Email**, then tap .
- 3 Tap **Settings** and select a corporate account.
- 4 Tap **Check frequency** and select an interval option.

To remove a corporate account

- 1 From your Home screen, tap .
- 2 Tap **Settings** > **Exchange ActiveSync**, then select the corporate account.
- 3 Tap , then tap **Remove account**.
- 4 Tap **Remove account** again to confirm.



Synchronising with Facebook™

There are two ways to use Facebook™ on your device. You can use the standard Facebook application to access your online Facebook account, or you can synchronise your Facebook account with your device and share content between Facebook™ and a range of other applications. For example, you can share music in the "WALKMAN" application on your device via Facebook. To synchronise your device with Facebook, you must first set up an "Xperia™ with Facebook" account.

To set up an "Xperia™ with Facebook" account on your device



- 1 From your Home screen, tap .
- 2 Tap **Settings** > **Add account** > **Xperia™ with Facebook**.
- 3 Follow the on-screen instructions to sign in to your Facebook™ account, or create a new account.

To synchronise manually with an "Xperia™ with Facebook" account

- 1 From your Home screen, tap .
- 2 Tap **Settings** > **Xperia™ with Facebook**.
- 3 Select the account that you want to synchronise.
- 4 Press , then tap **Sync now**.

To remove an "Xperia™ with Facebook" account

- ! When you remove an "Xperia™ with Facebook" account from your device, the associated online Facebook account is not deleted and you can still access it from a computer.

- 1 From your Home screen, tap .
- 2 Tap **Settings > Xperia™ with Facebook**.
- 3 Select the account that you want to remove.
- 4 Press , then tap **Remove account**.
- 5 Tap **Remove account** again to confirm.

Maps and locations

Location services and sources

Use your device to find out where you are. There are two methods, or sources: GPS satellites and wireless networks. Enable the wireless networks option (Wi-Fi and mobile networks) if you only need your approximate location, and want it fast. If you want a more exact position, and have a clear view of the sky, enable the GPS satellites option. In situations where the wireless network connection is weak, you should enable both options to ensure that your location is found. Both options are activated by default when you enable location services.

- ! Sony does not warrant the accuracy of any location services including but not limited to navigational services.

To enable location services

- 1 Drag the status bar downwards, then tap ✕.
- 2 Tap **Location services**.
- 3 Drag the slider beside **Access to my location** to the right.
- 4 Tap **Agree** twice to confirm.

- ! When you enable location services, both **GPS satellites** and **Google's location service** (Wi-Fi and mobile networks) get enabled by default. You can disable either option manually.

To allow Google apps to access your location

- 1 Drag the status bar downwards, then tap ✕.
- 2 Tap **Google > Location settings**.
- 3 Drag the slider beside **Let Google apps access your location** to the right.

- ! You must be logged into your Google™ account to be able to use location services.

Using GPS

Your device has a GPS (Global Positioning System) receiver that uses satellite signals to calculate your location. Your device also supports GLONASS (Global Navigation Satellite System). Both systems can complement and replace each other, if necessary, to ensure positioning accuracy and a smooth navigation experience. When you enable GPS, the GLONASS system also gets enabled automatically.

- ! When you use features that require the GPS and GLONASS receiver to find your location, make sure you have a clear view of the sky.

To enable GPS

- 1 Drag the status bar downwards, then tap ✕.
- 2 Tap **Location services**.
- 3 Drag the slider beside **Access to my location** to the right.
- 4 Tap **Agree** to confirm.

- ! When you enable GPS, the GLONASS system gets enabled automatically.

Getting the best performance

The first time you use the GPS it can take 5 to 10 minutes for your location to be found. To help the search, make sure you have a clear view of the sky. Stand still and don't cover the GPS antenna (the highlighted area in the image). The GPS signals can pass through clouds and plastic, but not through most solid objects such as buildings and mountains. If your location isn't found after a few minutes, move to another location.

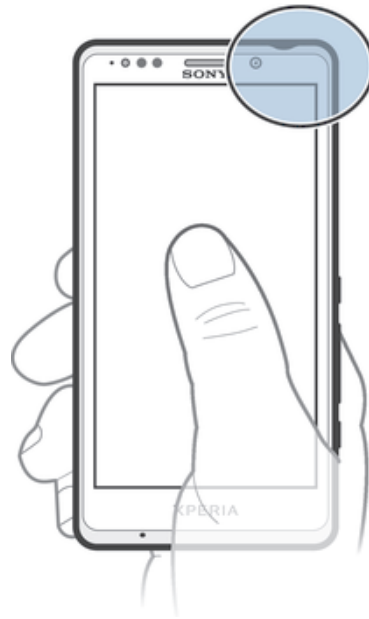

Google Maps™

Use Google Maps™ to track your current location, view real-time traffic situations and receive detailed directions to your destination. Before taking trips, you can download and save maps to your memory card to avoid high roaming costs.

- ! The Google Maps™ application requires the use of an Internet connection. You may incur data connection charges when you connect to the Internet from your device. Contact your network operator for more information. The Google Maps™ application may not be available in every market, country or region.

To use Google Maps™

- 1 From your Home screen, tap .
- 2 Find and tap **Maps**.

- ! If you want to use Google Maps™, you have to enable one of the location methods available under **Settings > Location services**.

To learn more about Google Maps™

- When you use Google Maps™, tap , then tap **Help**.

Viewing your friends' locations with Google Latitude™

Join Google Latitude™ to view your friends' locations on maps and share your location and other information with them.

Calendar and alarm clock

Calendar



About the calendar

Your device has a calendar for managing your time schedule. If you have a Google™ account, you can also synchronise your device calendar with your web calendar. See *Synchronising with Microsoft® Exchange ActiveSync®* on page 100.



To set the calendar view

- 1 From your Home screen, tap , then find and tap **Calendar**.
- 2 Tap the downwards arrow to open the drop down menu, then select an option.

To view multiple calendars

- 1 From your Home screen, tap , then find and tap **Calendar**.
- 2 Press , then tap **Calendars**.
- 3 Select the calendars you want to view.



To create a calendar event

- 1 From your Home screen, tap , then tap **Calendar**.
 - 2 Tap **+**.
 - 3 If you have synchronised your calendar with one or more accounts, select the account to which you want to add this event. If you only want to add this event on your device, tap **Device calendar**.
 - 4 Enter the name, time, location and description for the event.
 - 5 Tap **More** and select a reminder for the event. To add a new reminder for the event, tap **+**.
 - 6 If desired, select another option under **Repetition**.
 - 7 Tap **Done**.
-  When the appointment time approaches, your device plays a short sound to remind you. Also,  appears in the status bar.

To view a calendar event

- 1 From your Home screen, tap , then tap **Calendar**.
- 2 Tap the event you want to view.

To change the calendar settings

- 1 From your Home screen, tap , then tap **Calendar**.
- 2 Press , then tap **Settings**.
- 3 Tap the setting you want to change, then edit as desired.

Alarm clock

About the alarm clock

Use your device as an alarm clock and select any sound in your device as your alarm signal. The alarm does not sound if your device is turned off. But it does sound when your device is set to silent mode or Airplane mode. If you use one of these modes, you can keep your device on when you are sleeping and not get woken up by phone calls.

To open the alarm clock

- 1 From your Home screen, tap .
- 2 Find and tap **Alarm & clock**.

To set a new alarm

- 1 From your Home screen, tap .
- 2 Find and tap **Alarm & clock**.
- 3 Tap **+**.
- 4 Tap **Time** and adjust the time by scrolling up and down.
- 5 Tap **Set**.
- 6 If desired, edit other alarm settings.
- 7 Tap **Done**.

To edit an existing alarm

- 1 From your Home screen, tap .
- 2 Find and tap **Alarm & clock**.
- 3 Tap the alarm that you want to edit.
- 4 Tap **Time** and adjust the time by scrolling up and down.
- 5 Tap **Set**.
- 6 If desired, edit other alarm settings.
- 7 Tap **Done**.

- ! The alarm time format displayed is the same as the format you select for your general time settings, for example, 12-hour or 24-hour.

To deactivate an alarm

- 1 From your Home screen, tap .
- 2 Find and tap **Alarm & clock**.
- 3 Drag the slider to the left next to the alarm that you want to deactivate.

To activate an existing alarm

- 1 From your Home screen, tap .
- 2 Find and tap **Alarm & clock**.
- 3 Drag the slider to the right next to the alarm that you want to activate.

To delete an alarm

- 1 From your Home screen, tap .
- 2 Find and tap **Alarm & clock**.
- 3 Touch and hold the alarm you want to delete.
- 4 Tap **Delete alarm**, then tap **Yes**.

To set the ringtone for an alarm

- 1 From your Home screen, tap .
- 2 Find and tap **Alarm & clock**.
- 3 Tap the alarm you want to edit.
- 4 Tap **Alarm sound** and select an option, then tap **Done**.
- 5 Tap **Done**.

To set a recurring alarm

- 1 From your Home screen, tap .
- 2 Find and tap **Alarm & clock**.
- 3 Tap the alarm you want to edit.
- 4 Tap **Repeat**.
- 5 Mark the checkboxes for the desired days, then tap **OK**.
- 6 Tap **Done**.

To set the title for an alarm

- 1 From your Home screen, tap .
- 2 Find and tap **Alarm & clock**.
- 3 Tap the alarm that you want to edit.
- 4 Enter a name for the alarm in the **Alarm text** field.
- 5 Tap **Done**.

To activate the vibrate function for an alarm

- 1 From your Home screen, tap .
- 2 Find and tap **Alarm & clock**.
- 3 Tap the alarm you want to edit.
- 4 Mark the **Vibrate** checkbox.
- 5 Tap **Done**.

! The vibrate feature is enabled by default when you create a new alarm.

To set alarms to sound when the device is in silent mode

- 1 From your Home screen, tap .
- 2 Find and tap **Alarm & clock**, then tap to select an alarm.
- 3 Mark the **Alarm in silent mode** checkbox.
- 4 Tap **Done**.

! The alarm in silent mode feature is enabled by default when you create a new alarm.

To snooze an alarm when it sounds

- Tap **Snooze**.

To turn off an alarm when it sounds

- Slide  to the right.

Support and maintenance

Updating your device

Update your device to the most recent software version to get optimal performance and the latest enhancements. You can use the Update center application on your device to run a wireless update or you can use the PC Companion application on a computer to run an update using a USB cable connection.



If you update wirelessly, you can use either a mobile network or a Wi-Fi® network connection. Make sure you back up and save all data stored on your device before you run an update.

- ! New software releases may not be compatible with all devices. When you run an update using the Update center application, a data connection is established and related charges may be incurred. Also, the availability of updates over a mobile network depends on your operator. Contact your network operator for more information.

Updating your device wirelessly



Use the Update center application to update your device wirelessly. You can download software updates manually, or you can allow Update service to update your device automatically whenever downloads become available. When the automatic update feature is activated, a notification appears in the status bar every time an update becomes available.

To download software updates manually from Update center

- 1 From your Home screen, tap .
- 2 Find and tap **Update Center**.
- 3 Select the desired application or system update and tap , or tap  to download all application updates.



- ! Application updates launch automatically after download. With system updates, install the update manually after download. Your device will then restart automatically after the installation is finished. You may incur data connection charges when downloading updates over mobile networks.

To activate automatic software updates using the Update Center application

- 1 From your Home screen, tap .
- 2 Find and tap **Update Center**.
- 3 Press , then tap **Settings**.
- 4 Mark the **Allow automatic downloads** checkbox, then tap **Agree**. Updates are now downloaded automatically as soon as they become available.

- ! You may incur data connection charges when downloading updates over mobile networks.

To install system updates

- 1 From your Home screen, tap .
- 2 Find and tap **Update Center**.
- 3 Select a system update that you want to install, then tap .

Updating your device using a USB cable connection

Some updates are not available for wireless download. Notifications appear in the status bar to inform you of such updates. To download and run the updates, you need a USB cable and a computer running the PC Companion application. You can install PC Companion on the computer using installation files saved on your device, or you can download the application directly from www.sonymobile.com/support.

To launch the download of PC Companion using your device

- 1 Connect your device to a computer using a USB cable.
- 2 When prompted, follow the instructions in your device to launch the installation of PC Companion on the computer.

To download software updates using a USB cable connection

- 1 Install the PC Companion application on the computer you are using, if it is not already installed.
- 2 Connect your device to the computer using a USB cable.
- 3 **Computer:** Launch the PC Companion application. After a few moments, PC Companion detects your device and searches for new software for it.
- 4 **Device:** When notifications appear in the status bar, follow the on-screen instructions to carry out the relevant software updates.

To update your device using an Apple® Mac® computer

- 1 Install the Sony™ Bridge for Mac application on the Apple® Mac® computer that you are using, if it is not already installed.
 - 2 Using a USB cable, connect your device to the Apple® Mac® computer.
 - 3 **Computer:** Launch the Sony™ Bridge for Mac application. After a few moments, the Sony™ Bridge for Mac application detects your device and searches for new software for it.
 - 4 **Computer:** If a new software update is detected, a popup window appears. Follow the on-screen instructions to run the relevant software updates.
- ! The Sony™ Bridge for Mac application is downloadable from www.sonymobile.com/support.

Backup and restore application

Use the Backup and restore application to make backups of content to a memory card or a USB storage device. Such backups can be used to restore your content and some settings in cases where your data gets lost or deleted.

Types of content you can back up

Use the Backup and restore application to back up the following types of data:

- Bookmarks
 - Call log
 - Contacts
 - Applications downloaded from Google Play™
 - Multimedia messages
 - System settings (such as alarms, ringer volume, and language settings)
 - Text messages
- ! You may incur additional data transmission charges when you restore applications from Google Play™.

Preparing to use the Backup and restore application

Before backing up your content, you can select the backup destination and the types of data that you want to back up.

To select the backup destination

- 1 From your Home screen, tap .
- 2 Find and tap **Back up & restore**.
- 3 Tap **Back up**.
- 4 Tap the bar under **Where to store data**.
- 5 Select the destination to which you want to back up your content.

To select the data types to back up

- 1 From your Home screen, tap .
- 2 Find and tap **Back up & restore**.
- 3 Tap **Back up**.
- 4 Select the data types that you want to back up.

To back up content

- 1 From your Home screen, tap .
- 2 Find and tap **Back up & restore**.
- 3 Tap **Back up**, then tap **Back up now**.
- 4 Enter a password for the backup, then tap **OK**.

Restoring backed up content using the Backup and restore application

When you restore backed up content, you must select a backup record to restore from. If you have backed up content several times, you may have several backup records. After you select a backup record, you can then select which types of data to restore.

To restore content from a backup record



- 1 From your Home screen, tap .
- 2 Find and tap **Back up & restore**.
- 3 Tap **Restore**.
- 4 Select the record that you want to restore from, then tap **Restore now**.
- 5 Enter the password for the backup record, then tap **OK**.

- ! Remember that any changes you make to your data and settings after you create a backup will get deleted during a restore procedure.



Managing backup records

You can delete or rename records of the backups that you make using the Backup & restore function.

To rename a backup record

- 1 From your Home screen, tap .
- 2 Find and tap **Back up & restore**.
- 3 Press , then tap **Manage backup records**.
- 4 Select the backup record that you want to rename.
- 5 Tap .
- 6 Enter a new name and tap **Rename**.

To delete backup records

- 1 From your Home screen, tap .
- 2 Find and tap **Back up & restore**.
- 3 Press , then tap **Manage backup records**.
- 4 Select the backup record that you want to delete, or tap if you want to delete all records.
- 5 Tap  > **Delete**.

Resetting your device

You can reset your device to its original settings, with or without deleting all of your personal data. Before you perform a reset, make sure to back up any important data saved on your device.

To perform a factory data reset

- ! To avoid permanent damage to your device, do not restart your device while a reset procedure is underway.

- 1 Before you start, make sure to back up any important data that is saved on the internal memory of your device to a memory card or other non-internal memory.
- 2 From your Home screen, tap .
- 3 Find and tap **Settings** > **Backup & reset** > **Factory data reset**.
- 4 To delete information, such as pictures and music, from your internal storage, mark the **Erase internal storage** checkbox.
- 5 Tap **Reset phone**.
- 6 To confirm, tap **Erase everything**.

Locking and protecting your device

IMEI number

Every device has a unique IMEI (International Mobile Equipment Identity) number. You should keep a copy of this number. If your device is stolen, your network provider can use your IMEI number to stop the device from accessing the network in your country.

To view your IMEI number

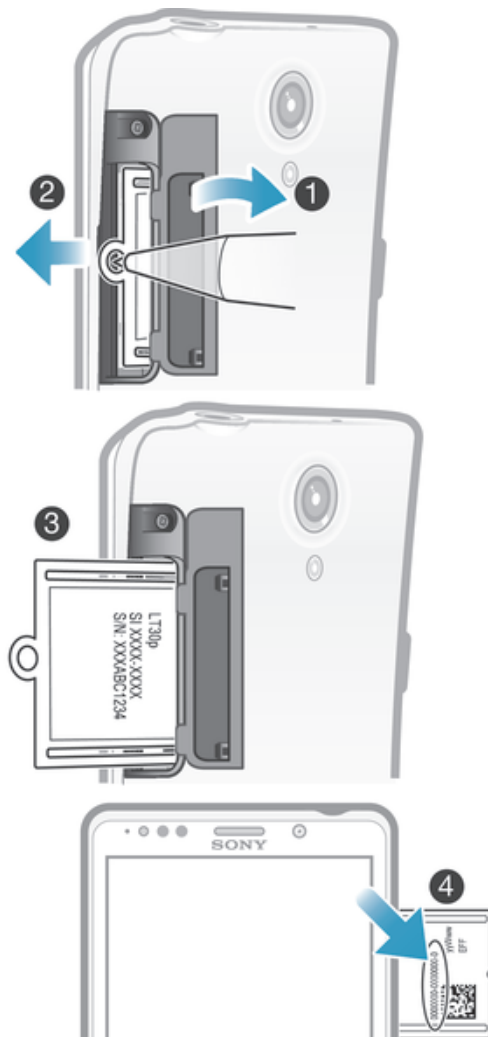

- 1 Remove the cover of the memory card and micro SIM card slots.
 - 2 Insert a fingernail, or a sharp object such as a pen, into the hole in the label tray, then drag the tray outwards to view the IMEI number.
-  You can also open the phone dialer on your device and enter ***#06#** to view the IMEI number.

To view your IMEI number in the device

- 1 From your Home screen, tap .
- 2 Find and tap **Settings** > **About phone** > **Status**.
- 3 Scroll to **IMEI** to view the IMEI number.

Setting a screen lock

There are several ways to lock the screen on your device. For example, you can use the Face Unlock feature, which uses a picture of your face to unlock the screen. You can also set a screen unlock pattern, a number-based PIN lock, or a text-based password.

It is very important that you remember your screen unlock pattern, PIN or password. If you forget this information, it may not be possible to restore important data such as contacts and messages. Refer to Sony customer support for more information.

To set a screen lock

- 1 From your Home screen, tap  > **Settings** > **Security** > **Screen lock**.
- 2 Select an option.

To set up the Face Unlock feature

- 1 From your Home screen, tap  > **Settings** > **Security** > **Screen lock**.
- 2 Tap **Face Unlock**, then follow the instructions in your device to capture your face.
- 3 After your face is successfully captured, tap **Continue**.
- 4 Select a backup lock method and follow the instructions in the device to complete the setup.

! The Face Unlock feature is less secure than a screen lock pattern, PIN, or password. Someone who looks similar to you could unlock your device.

💡 For best results, capture your face in an indoor area that is well lit but not too bright, and hold the device at eye level.

To unlock the screen using the Face Unlock feature

- 1 Activate the screen.
- 2 Look at your device from the same angle you used to capture your Face Unlock photo.

💡 If the Face Unlock feature fails to recognise your face, you need to draw the backup pattern or enter the PIN to unlock the screen.

To disable the Face Unlock feature

- 1 From your Home screen, tap  > **Settings** > **Security** > **Screen lock**.
- 2 Draw your backup screen unlock pattern or enter your PIN.
- 3 Tap **Swipe**.

To create a screen unlock pattern

- 1 Drag the status bar downwards, then tap .
- 2 Tap **Security** > **Screen lock** > **Pattern**.
- 3 Follow the instructions in your device.

To unlock the screen using a screen unlock pattern

- 1 Activate the screen.
- 2 Draw your screen unlock pattern.

! If the unlock pattern you draw on the screen is rejected five times in a row, you must wait 30 seconds and then try again.



To change the screen unlock pattern

- 1 From your Home screen, tap .
- 2 Find and tap **Settings** > **Security** > **Screen lock**.
- 3 Draw your screen unlock pattern.
- 4 Tap **Pattern**.
- 5 Follow the instructions in your device.

To disable the screen unlock pattern

- 1 From your Home screen, tap  > **Settings** > **Security** > **Screen lock**.
- 2 Draw the screen unlock pattern.
- 3 Tap **Swipe**.



To create a screen unlock PIN

- 1 From your Home screen, tap  > **Settings** > **Security** > **Screen lock** > **PIN**.
- 2 Enter a numeric PIN.
- 3 If necessary, tap  to minimise the keyboard.
- 4 Tap **Continue**.
- 5 Re-enter and confirm your PIN.
- 6 If necessary, tap  to minimise the keyboard.
- 7 Tap **OK**.

To disable the screen unlock PIN

- 1 From your Home screen, tap  > **Settings** > **Security** > **Screen lock**.
- 2 Enter your PIN, then tap **Next**.
- 3 Tap **Swipe**.

To create a screen lock password

- 1 From your Home screen, tap  > **Settings** > **Security** > **Screen lock** > **Password**.
- 2 Enter a password.
- 3 If necessary, tap  to minimise the keyboard.
- 4 Tap **Continue**.
- 5 Re-enter and confirm your password.
- 6 If necessary, tap  to minimise the keyboard.
- 7 Tap **OK**.

To disable the screen unlock password

- 1 From your Home screen, tap  > **Settings** > **Security** > **Screen lock**.
- 2 Enter your password and tap **Next**.
- 3 Tap **Swipe**.

Finding your device

There are several ways to find and protect your device if you ever lose it. Using the “my Xperia” service, you can:

- Look for your device on a map.
 - Sound an alert which works even if the device is in silent mode.
 - Remotely lock the device and display your contact information on it.
 - Remotely wipe the internal and external memories on the device as a last resort.
- Before using the “my Xperia” service, you must activate it on your device. Once the service is activated, all you have to do is go to myxperia.sonymobile.com and sign in using the same Google™ account that you have set up on your device.

- ! The “my Xperia” service may not available in all countries/regions.

To activate the “my Xperia” service

- 1 Drag the status bar downwards, then tap .
- 2 Tap **Security** > **MyXperia™** > **Activate**.
- 3 Mark the checkbox, then tap **Accept**.

Support application

To access the Support application

- 1 From your Application screen, find and tap .
- 2 Find and tap the required support item.

Recycling your device





























Got an old device lying around the house? Why not recycle it? By doing so, you will help us reuse its materials and components, and you'll protect the environment, too! Find out more about the recycling options in your region at www.sonymobile.com/recycle.

Reference

Status and notification icons overview

Status icons

















The following status icons may appear on your screen:

	Signal strength
	No signal
	Roaming
	GPRS is available
	EDGE is available
	LTE is available
	NFC is activated
	3G is available
	Sending and downloading GPRS data
	Sending and downloading EDGE data
	Sending and downloading 3G data
	Network is available
	Sending and downloading data
	STAMINA mode is activated
	Battery status
	The battery is charging
	GPS is activated
	Airplane mode is activated
	The Bluetooth® function is activated
	The SIM card is not inserted
	The microphone is muted
	The speakerphone is on
	Silent mode
	Vibrate mode
	An alarm is set
	Synchronisation is ongoing
	Problem with sign in or synchronisation
	A Wi-Fi® connection is enabled and wireless networks are available













! Depending on your service provider, network and/or region, the functions or services represented by some icons in this list may not be available.















Notification icons

The following notification icons may appear on your screen:

-  New email message
-  New text message or multimedia message
-  New voicemail
-  Upcoming calendar event
-  A song is playing
-  The device is connected to a computer via a USB cable
-  Warning message
-  Error message
-  Missed call
-  Call ongoing
-  Call on hold
-  Call forwarding is turned on
-  Software updates are available
-  Downloading data
-  Uploading data
-  More (undisplayed) notifications

Application overview

-  Use the Alarm and clock application to set various kinds of alarms.
-  Use your web browser to navigate and view web pages, manage bookmarks, and manage text and images.
-  Use the Calculator application to perform basic calculations.
-  Use the Calendar application to keep track of your events and manage your appointments.
-  Use the camera to take photos and record video clips.
-  Use the Contacts application to manage phone numbers, email address and other information related to your contacts.
-  Access your downloaded applications.
-  Use the Email application to send and receive emails through both private and corporate accounts.
-  Use the Facebook application to engage in social networking with friends, family members and colleagues around the world.
-  Browse and listen to FM radio stations.
-  Use the Album application to view and to work with your photos and videos.
-  Use the Gmail™ application to read, write and organise email messages.
-  Search for information in your device and on the web.

-  View your current location, find other locations, and calculate routes using Google Maps™.
-  Go to Google Play™ to download free and paid applications for your device.
-  Use the Messaging application to send and receive text and multimedia messages.
-  Use the Movies application to play videos in your device and share content with your friends.
-  Use the "WALKMAN" application to organise and play music, audio books and podcasts.
-  View news stories and weather forecasts.
-  Make phone calls by dialling the number manually or by using the smart dial function.
-  Use the Video Unlimited application to rent and purchase videos.
-  Optimise settings to suit your own requirements.
-  Use the Hangouts™ application to chat with friends online.
-  Identify music tracks that you hear playing in your surroundings, and get artist, album and other info.
-  Use YouTube™ to share and view videos from around the world.
-  Use the Support application to access user support in the device. For example, you can access a User guide, troubleshooting information, plus tips and tricks.
-  Download and install new applications and updates.

! Some applications are not supported by all networks and/or service providers in all areas.

Important information

Important information leaflet

Before you use your device, please read the Important information leaflet provided in the Setup guide in your device or in the box.

To access the setup guide manually

- 1 From the Home screen, tap .
- 2 Tap **Settings** > **Setup guide**.

Limitations to services and features

Some of the services and features described in this User guide are not supported in all countries/regions or by all networks and/or service providers in all areas. Without limitation, this applies to the GSM International Emergency Number, 112. Please contact your network operator or service provider to determine availability of any specific service or feature and whether additional access or usage fees apply.

Use of certain features and applications described in this guide may require access to the Internet. You may incur data connection charges when you connect to the Internet from your device. Contact your wireless service provider for more information.

Legal information

SonyLT30p

This User guide is published by Sony Mobile Communications AB or its local affiliated company, without any warranty. Improvements and changes to this User guide necessitated by typographical errors, inaccuracies of current information, or improvements to programs and/or equipment, may be made by Sony Mobile Communications AB at any time and without notice. Such changes will, however, be incorporated into new editions of this User guide.

©Sony Mobile Communications AB, 2013.

All rights reserved.

Your mobile device has the capability to download, store and forward additional content, for example, ringtones. The use of such content may be restricted or prohibited by rights of third parties, including but not limited to restriction under applicable copyright laws. You, and not Sony, are entirely responsible for additional content that you download to or forward from your mobile device. Prior to your use of any additional content, please verify that your intended use is properly licenced or is otherwise authorized. Sony does not guarantee the accuracy, integrity or quality of any additional content or any other third party content. Under no circumstances will Sony be liable in any way for your improper use of additional content or other third party content.

This User guide may reference services or applications provided by third parties. Use of such programming or services may require separate registration with the third party provider and may be subject to additional terms of use. For applications accessed on or through a third-party website, please review such websites' terms of use and applicable privacy policy in advance. Sony does not warrant or guarantee the availability or performance of any third-party websites or offered services.

All product and company names mentioned herein are the trademarks or registered trademarks of their respective owners. Any rights not expressly granted herein are reserved. All other trademarks are property of their respective owners.

Visit www.sonymobile.com for more information.

All illustrations are for illustration purposes only and may not accurately depict the actual device.

This product is protected by certain intellectual property rights of Microsoft. Use or distribution of such technology outside of this product is prohibited without a licence from Microsoft.

Content owners use Windows Media digital rights management technology (WMDRM) to protect their intellectual property, including copyrights. This device uses WMDRM software to access WMDRM-protected content. If the WMDRM software fails to protect the content, content owners may ask Microsoft to revoke the software's ability to use WMDRM to play or copy protected content. Revocation does not affect unprotected content. When you download licences for protected content, you agree that Microsoft may include a revocation list with the licences. Content owners may require you to upgrade WMDRM to access their content. If you decline an upgrade, you will not be able to access content that requires the upgrade.

This product is licenced under the MPEG-4 visual and AVC patent portfolio licences for the personal and non-commercial use of a consumer for (i) encoding video in compliance with the MPEG-4 visual standard ("MPEG-4 video") or the AVC standard ("AVC video") and/or (ii) decoding MPEG-4 or AVC video that was encoded by a consumer engaged in a personal and non-commercial activity and/or was obtained from a video provider licenced by MPEG LA to provide MPEG-4 and/or AVC video. No licence is granted or shall be implied for any other use. Additional information including that relating to promotional, internal and commercial uses and licensing may be obtained from MPEG LA, L.L.C. See <http://www.mpegla.com>. MPEG Layer-3 audio decoding technology licenced from Fraunhofer IIS and Thomson.

SONY MOBILE WILL NOT BE LIABLE FOR ANY LOSS, ERASE AND/OR DATA-OVERWRITING OF PERSONAL DATA OR FILES STORED ON YOUR PHONE (INCLUDING BUT NOT LIMITED TO CONTACTS, MUSIC TRACKS AND PICTURES) ARISING OUT OF ANY UPDATE OF YOUR DEVICE BY ANY OF THE METHODS DESCRIBED IN THIS USER'S GUIDE, AS WELL AS ARISING OUT OF THE USE OF ANY OF THE INDICATIONS AND TIPS PROVIDED UNDER THE SUBSECTIONS "METHODS FOR TRANSFERRING CONTACTS" AND "DATA STORAGE" OF THIS DOCUMENT. IN NO EVENT SHALL SONY MOBILE'S OR ITS SUPPLIERS' TOTAL LIABILITY TO YOU FOR ANY AND ALL DAMAGES, LOSSES AND CAUSES OF ACTION

(WHETHER IN CONTRACT OR TORT, INCLUDING, BUT NOT LIMITED TO NEGLIGENCE OR OTHERWISE)
EXCEED THE AMOUNT ACTUALLY PAID BY YOU FOR YOUR DEVICE.