

JVC



ENGLISH

ESPAÑOL

FRANÇAIS

KD-R538/KD-A535/KD-R530 KD-R438/KD-R430

CD RECEIVER / RECEPTOR CON CD / RÉCEPTEUR CD

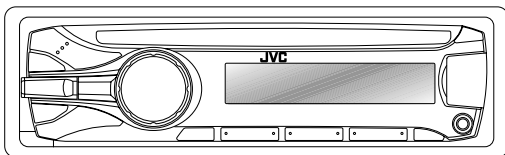
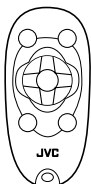
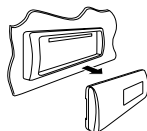

WMA MP3



Made for



iPod



iPhone

works with

PANDORA
internet radio



For canceling the display demonstration, see page 4. /

Para cancelar la demostración en pantalla, consulte la página 4. /

Pour annuler la démonstration des affichages, référez-vous à la page 4.

For installation and connections, refer to the separate manual.
Para la instalación y las conexiones, refiérase al manual separado.
Pour l'installation et les raccordements, se référer au manuel séparé.

For Customer Use:

Enter below the Model No. and Serial No. which are located on the top or bottom of the cabinet. Retain this information for future reference.

Model No. _____

Serial No. _____

INSTRUCTIONS

MANUAL DE INSTRUCCIONES
MANUEL D'INSTRUCTIONS

GET0769-001A

[J]

Thank you for purchasing a JVC product.

Please read all instructions carefully before operation, to ensure your complete understanding and to obtain the best possible performance from the unit.

■ INFORMATION (For U.S.A.)

This equipment has been tested and found to comply with the limits for a Class B digital device, pursuant to Part 15 of the FCC Rules. These limits are designed to provide reasonable protection against harmful interference in a residential installation. This equipment generates, uses, and can radiate radio frequency energy and, if not installed and used in accordance with the instructions, may cause harmful interference to radio communications. However, there is no guarantee that interference will not occur in a particular installation. If this equipment does cause harmful interference to radio or television reception, which can be determined by turning the equipment off and on, the user is encouraged to try to correct the interference by one or more of the following measures:

- Reorient or relocate the receiving antenna.
- Increase the separation between the equipment and receiver.
- Connect the equipment into an outlet on a circuit different from that to which the receiver is connected.
- Consult the dealer or an experienced radio/TV technician for help.

■ Caution:

Changes or modifications not approved by JVC could void the user's authority to operate the equipment

■ IMPORTANT FOR LASER PRODUCTS

1. CLASS 1 LASER PRODUCT

2. **CAUTION:** Do not open the top cover. There are no user serviceable parts inside the unit; leave all servicing to qualified service personnel.

3. **CAUTION:** (For U.S.A.) Visible and/or invisible class II laser radiation when open. Do not stare into beam.

(For Canada) Visible and/or invisible class 1M laser radiation when open. Do not view directly with optical instruments.

4. REPRODUCTION OF LABEL: CAUTION LABEL, PLACED OUTSIDE THE UNIT.

CAUTION VISIBLE AND/OR INVISIBLE CLASS 1M LASER RADIATION WHEN OPEN. DO NOT VIEW DIRECTLY WITH THE EYES REGARDING OPTICAL INSTRUMENTS. IEC60825-1:2001 (EN3)	ATTENTION RAYONNEMENT LASER VISIBLE ET/OU INVISIBLE DE CLASSE 1M UNE FOIS OUVERT. NE PAS REGARDER DIRECTEMENT AVEC DES INSTRUMENTS OPTIQUES. (FR)	AVISO RADIACION LASER DE CLASE 1M VISIBLE Y/O INVISIBLE CUANDO ESTA ABIERTO. NO MIRAR DIRECTAMENTE CON INSTRUMENTAL OPTICO. (ES)	VARNING SYNLIG OCH/ELLER OSYNLIG LASERSTRÅLNING, KLASS 1M, NÅR DENNA ÄR ÖPPNAD. BETRÄKTA EJ STRÅLEN MED OPTISKA INSTRUMENT. (SWE)	注意 この製品と管理 及び/または互換性 のクラス1M レーザー放射が 露出する 光学機器で直接 見ないでください。 (JPN)	CAUTION VISIBLE AND/OR INVISIBLE CLASS I LASER RADIATION WHEN OPEN. DO NOT STARE INTO BEAM. FDA 21 CFR (EN3)
--	---	--	---	---	---



[European Union only]

Warning:

Stop the car before operating the unit.

Caution:

Adjust the volume so that you can hear sounds outside the car. Driving with the volume too high may cause an accident.

Avoid using the USB device or iPod/iPhone if it might hinder driving safety.

Caution on volume setting:

Digital devices (CD/USB) produce very little noise compared with other sources. Lower the volume before playing these digital sources to avoid damaging the speakers by the sudden increase of the output level.

Temperature inside the car:

If you have parked the car for a long time in hot or cold weather, wait until the temperature in the car becomes normal before operating the unit.

Condensation:

When the car is air-conditioned, moisture may collect on the laser lens. This may cause disc read errors. In this case, remove the disc and wait for the moisture to evaporate.

How to attach/detach the control panel

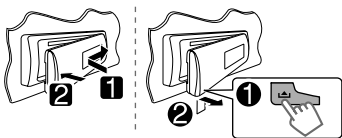

How to reset your unit

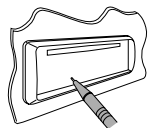

Your preset adjustments will also be erased.

How to forcibly eject a disc

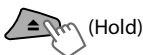

- Be careful not to drop the disc when it ejects.
- If this does not work, reset your unit.

Contents

Preparation	4
Canceling the display demonstration	
Setting the clock	
Basic operations	4
Radio	6
CD/USB	7
iPod/iPhone (KD-R538/KD-A535/KD-R530 only)	8
External components	10
Bluetooth®	10
Illumination color adjustments (KD-R538/KD-A535/KD-R530/KD-R438 only)	11
Brightness adjustments	12
Sound adjustments	12
Remote controller	13
Menu operations	14
Additional information	16
Troubleshooting	18
Specifications	19

How to read this manual:

- This manual mainly explains operations using the buttons on the control panel.
- < > indicates the displays on the control panel.
- [XX] indicates the initial setting of a menu item.

Maintenance

Cleaning the unit

Wipe off the dirt on the panel with a dry silicon or soft cloth. Failure to observe this precaution may result in damage to the unit.







Cleaning the connector

Wipe off dirt on the connector of the unit and panel. Use a cotton swab or cloth.













Preparation

Canceling the display demonstration

The display demonstration is always turned on unless you cancel it.



- 1  (Hold) 
- 2  
- 3 Select <DEMO OFF>.   → 
- 4 Press **MENU** to exit.

Setting the clock

- 1  (Hold) 
- 2 Select <CLOCK>.   → 
- 3 Select <CLOCK SET>.  → 
- 4 Adjust the hour.   → 
- 5 Adjust the minute.   → 
- 6 Press **MENU** to exit.

Basic operations

Display information

-  **DISP** Changes the display information. (Press)
 **DISP** Scrolls the current display information. (Hold)

Source	Display
Radio	Frequency ↔ Clock
CD/USB	Album title/Artist* → Track title* → Track no./Playing time → Clock → (back to the beginning) * "NO NAME" appears for conventional CDs or if not recorded.
iPod/iPhone (HEAD MODE/ IPOD MODE) *1	
iPod/iPhone (EXT MODE) *1	EXT MODE ↔ Clock
iPod/iPhone (Pandora® internet radio) *2	Station name → Album title/Artist → Track title → Playing time → Clock → (back to the beginning)
External Components (AUX)	F-AUX or R-AUX ↔ Clock
Bluetooth Audio	BT AUDIO ↔ Clock

*1 For KD-R538/KD-A535/KD-R530 only.

*2 For KD-A535/KD-R530 only.

Control panel

Remote controller

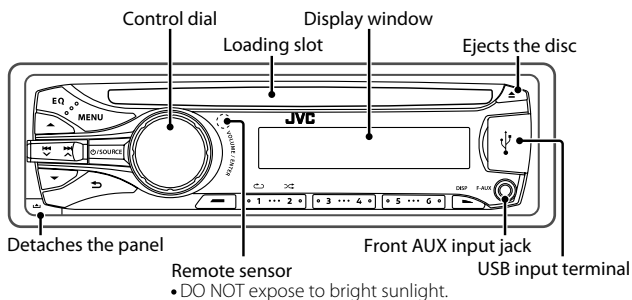

When you press or hold the following button(s)...

Control panel	Remote controller	General function
/SOURCE	—	<ul style="list-style-type: none"> • Turns on. • Turns off. (Hold) • Press the /SOURCE button on the control panel and turn the control dial within 2 seconds to select the source.
	SOURCE	Press repeatedly to select the source.
Control dial (turn)	VOL - / +	Adjusts the volume level.
	—	Selects items.
Control dial (press)		<ul style="list-style-type: none"> • Mutes the sound or pauses playback. • Press the button again to cancel muting or resume playback.
	—	Confirms selection.
	—	Enters <BRIGHTNESS> menu directly. (KD-R438/KD-R430 only) (☞ page 12)
iPod	—	Switches to iPod source. (KD-R538/KD-A535/KD-R530 only)
Number buttons (1 - 6)	—	<ul style="list-style-type: none"> • Selects the preset stations. • Stores the current station into the selected number button. (Hold) (☞ page 6)
	SOUND	Selects the preset sound mode. (☞ page 12)
	—	<ul style="list-style-type: none"> • Returns to the previous menu. • Exits from the menu. (Hold)
		<ul style="list-style-type: none"> • Selects a preset station. (☞ page 6) • Selects MP3/WMA folder. (☞ page 7)
		• Searches for a station automatically. (☞ page 6)
		• Searches for a station manually. (Hold)
		• Selects track. (☞ page 7, 8)
		• Fast-forwards or reverses track. (Hold)

Radio

Searching for a station

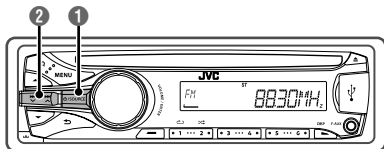

- 1 Select <FM> or <AM>.
- 2 Auto search. (Press)
Manual search. (Hold)
"M" flashes, then press the button repeatedly.

"ST" lights up when receiving an FM stereo broadcast with sufficient signal strength.

Storing stations in memory

Manual presetting

You can preset up to 18 stations for FM and 6 stations for AM.

While listening to a station...

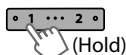

The preset number flashes and "MEMORY" appears. The current station is stored to the selected number button (1 - 6).

- or -----
- 1 (Hold)

"PRESET MODE" flashes.

- 2 Select preset number.

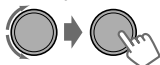

The preset number flashes and "MEMORY" appears.

Auto presetting (FM only)

SSM (Strong-station Sequential Memory)

You can preset up to 18 stations for FM.

- 1 (Hold)

- 2 → <TUNER>
 → <SSM>
 → <SSM 01 - 06>

"SSM" flashes. When all the stations are stored, "SSM" stops flashing.

To preset <SSM 07 - 12>/<SSM 13 - 18>, repeat steps 1 and 2.

Selecting a preset station

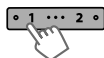

----- or -----

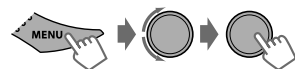

You can also select a preset station using ▲ / ▼.

Setting the Radio Timer

You can tune in to a preset station at a specific time regardless of the current source.

- 1 (Hold)

- 2 → <TUNER>
 → <RADIO TIMER>
 → <OFF>/<ONCE>/<DAILY>

[OFF]	Cancels Radio Timer.
ONCE	Activates once.
DAILY	Activates daily.

- 3 Select the preset station.

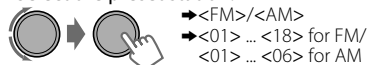

- 4 Set the activation time.

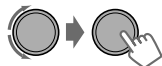

- 5 Press **MENU** to exit.

- lights up after the Radio Timer has been set.
- Only one timer can be set. Setting a new timer will override the previous setting.
- The Radio Timer will not activate if the unit is turned off or if <AM> is set to <OFF> after selecting an AM station for the timer.

Playing a CD/USB device

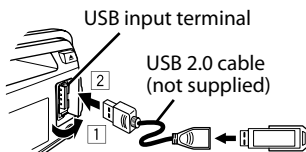
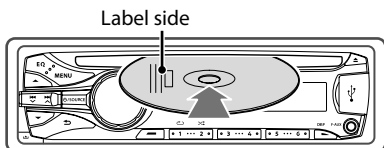

The source changes to "CD" and playback starts.

The source changes to "USB" and playback starts.

- This unit can play MP3/WMA files stored in CD-R, CD-RW, and USB mass storage device (such as a USB memory and Digital Audio Player).
- Make sure all important data has been backed up. We shall bear no responsibility for any loss of data in USB mass storage class device while using this system.
- Ejected disc not removed within 15 seconds will reload automatically.
- If the disc cannot be ejected, see page 3.

Selecting a folder/track

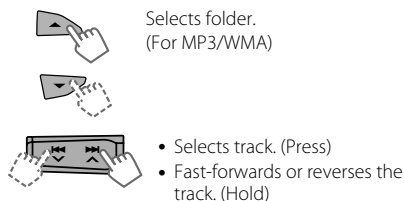

Selects folder.
(For MP3/WMA)

- Selects track. (Press)
- Fast-forwards or reverses the track. (Hold)

Selecting a track/folder from the list

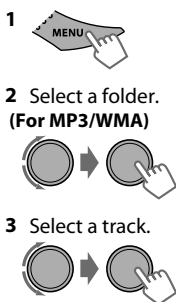

2 Select a folder.
(For MP3/WMA)

3 Select a track.

- **For MP3/WMA**
If the disc contains many folders or tracks, you can fast search for desired folder or track by turning the control dial quickly.

Selecting the playback modes

You can select one of the following playback modes at a time.



-----or-----

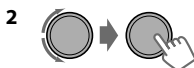

REPEAT

RPT OFF	Cancels repeat playback.
TRACK RPT	Repeats current track.
FOLDER RPT *	Repeats current folder.

RANDOM

RND OFF	Cancels random playback.
FOLDER RND *	Randomly plays all tracks of current folder, then tracks of next folders.
ALL RND	Randomly plays all tracks.

* For MP3/WMA

iPod/iPhone

KD-R538/KD-A535/KD-R530 only

Playing an iPod/iPhone

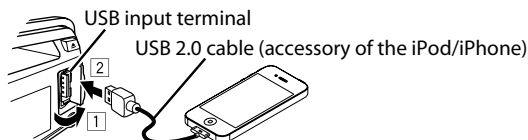

The source changes to "USB" → "USB-IPOD" and playback starts.

Selecting the control mode

iPod MODE ⇔ <HEAD MODE>/<IPOD MODE>/<EXT MODE>



HEAD MODE	Controls iPod playback through this unit.
IPOD MODE	Controls iPod playback from the iPod/iPhone.
EXT MODE	Allows any audio signals from iPod/iPhone.

- You can also change the setting using <IPOD SWITCH> in the menu.

Selecting a track

Applicable under <HEAD MODE/IPOD MODE> only.

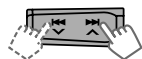

- Selects track/chapter. (Press)
- Fast-forwards or reverses the track. (Hold)

Selecting a track from the list

Applicable under <HEAD MODE> only.



- Select the desired list.

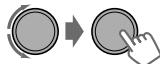

PLAYLISTS ⇔ ARTISTS ⇔ ALBUMS ⇔ SONGS ⇔
PODCASTS ⇔ GENRES ⇔ COMPOSERS ⇔ (back to the beginning)

- Select the desired track.

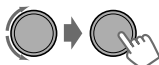

Repeat this step until the desired track is selected.

- If the selected menu contains many tracks, you can fast search for the desired track by turning the control dial quickly.

Selecting the playback modes

Applicable under <HEAD MODE> only.

You can select one of the following playback modes at a time.

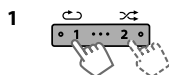

Press **1** for REPEAT.
Press **2** for RANDOM.
Press again to exit.

----- or -----



<REPEAT> ⇔ <RANDOM>

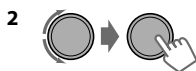

REPEAT ↺

ONE RPT	Functions the same as "Repeat One" of the iPod.
ALL RPT	Functions the same as "Repeat All" of the iPod.

RANDOM ⇄

RND OFF	Cancels random playback.
SONG RND	Functions the same as "Shuffle Songs" of the iPod.
ALBUM RND	Functions the same as "Shuffle Albums" of the iPod.

- "ALBUM RND" is not applicable for some iPod/iPhone.

Pandora® internet radio

KD-A535/KD-R530 only

■ Preparation

- 1 Search for "Pandora" in the Apple iTunes App Store to find and install the most current version of the Pandora® application onto your device.
- 2 In the application on your device, log in and create an account with Pandora®. If you are not already a registered user, an account can also be created at www.pandora.com.
 - Pandora® is only available in the US.
 - Because Pandora® is a third-party service, the specifications are subject to change without prior notice. Accordingly, compatibility may be impaired or some or all of the services may become unavailable.
 - Some functions of Pandora® cannot be operated from this unit.
 - For issues using the application, please contact Pandora at pandora-support@pandora.com.

■ Listening to Pandora® internet radio

- 1 Open the Pandora® application on your device.
- 2 Connect the device to the USB terminal. The source switches and broadcast starts automatically from your current station.

■ Basic Operations



Starts/pauses playback.



Selects thumbs up/thumbs down.



- If thumbs down is selected, current track is skipped.



Skips track.

■ Searching the registered station from the list

1



2 Select the station list display mode.

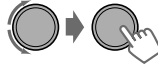

BY DATE	According to the registration date
A - Z	Alphabetical order

3 Select the desired station.

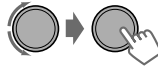

To bookmark song/artist information

While receiving a song...

1



(Hold)

2

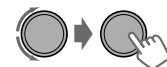

<THIS SONG> ↔ <THIS ARTIST>

"BOOKMARKED" appears and the song/artist information is stored to the iPod/iPhone.

- This unit allows you to bookmark songs and/or artists in your personalized Pandora® account. The bookmarks will not be available for review on the unit but will be available in your Pandora® account.

External components

For details, refer also to the instructions supplied with the external components.

Playing an external component from Front/Rear AUX

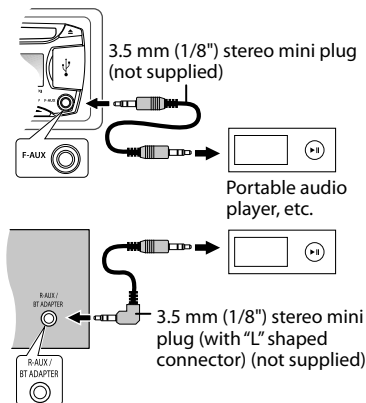

1 Connect to F-AUX on the control panel and/or R-AUX on the rear panel.

2 Set the source as necessary.

- 1 (Hold)
- 2 → <SRC SELECT>
 → <F-AUX>/<R-AUX>
 → <F-AUX ON> or <R-AUX ON>

3 Press **MENU** to exit.

3 Select <F-AUX> or <R-AUX>.



4 Turn on the connected component and start playing the source.



Recommended to use a 3-terminal plug head stereo mini plug for optimum audio output. Otherwise, sound may be interrupted or unclear while listening to an external component.

Bluetooth®

For Bluetooth operations, it is required to connect the Bluetooth adapter, KS-BTA100 (separately purchased) to the auxiliary input jack (R-AUX/BT ADAPTER) on the rear of the unit. (See Installation/Connection Manual)

- KS-BTA100 is not available in some countries. Please contact your dealer where you purchased this unit.
- Operations may be different depending on the connected Bluetooth device. For details, refer also to the instruction supplied with the device.

KS-BTA100



Preparation

For details on registering and using the Bluetooth device, refer to the instructions manual supplied with KS-BTA100.

1 Register (pair) a Bluetooth device with KS-BTA100.

2 Change the <SRC SELECT> settings of this unit.

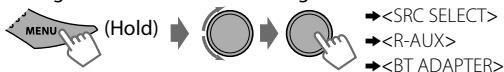

3 Press **MENU** to exit.

Illumination color adjustments

KD-R538/KD-A535/KD-R530/KD-R438 only

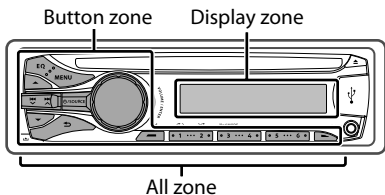

All zone: Includes both Button zone and Display zone.

Selecting the preset color

You can select a preset color for <BUTTON ZONE>, <DISP ZONE>, and <ALL ZONE> separately.

1 (Hold)

2 Select <COLOR>.

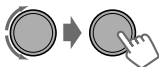

3

BUTTON ZONE	COLOR 01-29/USER/ COLOR FLOW 01-03*
DISP ZONE	* Color changes in different speeds.
ALL ZONE	

- Initial color: BUTTON ZONE [06], DISP ZONE [01], ALL ZONE [06].
- If <ALL ZONE> is selected, the button and display illumination will change to the current/selected <BUTTON ZONE> color.

4 Press **MENU** to exit.

Storing your own adjustments

You can store your own day and night colors for <BUTTON ZONE> and <DISP ZONE> separately.

1 (Hold)

2 Select <COLOR SETUP>.

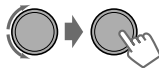

3

DAY COLOR	BUTTON ZONE	<ul style="list-style-type: none"> • Select a primary color <RED/GREEN/BLUE>, and then adjust the level <00-31>. Repeat this procedure until you have adjusted all the three primary colors.
	DISP ZONE	
NIGHT COLOR	BUTTON ZONE	<ul style="list-style-type: none"> • Your adjustment is automatically stored to "USER". • If "00" is selected for all the primary colors for <DISP ZONE>, nothing appears on the display.
	DISP ZONE	
MENU COLOR	ON	Changes the display and buttons illumination during menu, list search, and playback mode operations.
	OFF	

- NIGHT COLOR/DAY COLOR is changed by turning on/off your car's headlight.

4 Press **MENU** to exit.

Brightness adjustments

You can select your preferred brightness for <BUTTON ZONE>, <DISP ZONE> separately.



- Brightness button is only available for KD-R438/KD-R430.
- For KD-R538/KD-A535/KD-R530, page 14.

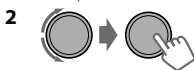

BUTTON ZONE	BUTTON 00 to 31
DISP ZONE	DISP 00 to 31

3 Press **MENU** to exit.

Sound adjustments

Selecting the preset sound

You can select a preset sound mode, for each individual source, suitable for the music genre.



----- or -----



Press repeatedly.

DYNAMIC → VOCAL BOOST → BASS BOOST → USER → FLAT → NATURAL (back to the beginning)

Storing your own adjustments

Easy Equalizer

While listening, you can adjust the subwoofer level and tone level of the selected sound mode.



2 Adjust the level.

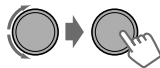

(Initial: **[XX]**)

SUB.W*	00 to 08 [08]
BASS LVL**	-06 to +06 [+05]
MID LVL	-06 to +06 [00]
TRE LVL	-06 to +06 [+05]

The adjustments are stored and <USER> is activated.

* Available only when <L/O MODE> is set to <SUB.W>. page 14)

** Available only when <HPF> is set to <OFF>. page 15)

Pro Equalizer

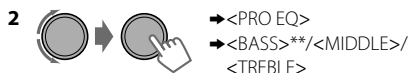

** Available only when <HPF> is set to <OFF>. page 15)

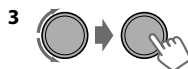

Adjust the sound elements of the selected tone.

BASS (Initial: **[XX]**)

Frequency	60/80/[100]/200 Hz
Level	LVL -06 to +06 [+05]
Q	[Q1.0]/Q1.25/Q1.5/Q2.0

MIDDLE

Frequency	0.5/[1.0]/1.5/2.5 kHz
Level	LVL -06 to +06 [00]
Q	Q0.75/Q1.0/[Q1.25]

TREBLE

Frequency	10.0/[12.5]/15.0/17.5 kHz
Level	LVL -06 to +06 [+05]
Q	[Q FIX]

4 Repeat steps 2 and 3 to adjust other tones. The adjustments are stored and <USER> is activated.

5 Press **MENU** to exit.

Remote controller

Preparing

When you use the remote controller for the first time, pull out the insulation sheet.



For USA-California Only:

This product contains a CR Coin Cell Lithium Battery which contains Perchlorate Material—special handling may apply. See

www.dtsc.ca.gov/hazardouswaste/perchlorate

Replacing the lithium coin battery

- If the effectiveness of the remote controller decreases, replace the battery.



Caution:

- Danger of explosion if battery is incorrectly replaced. Replace only with the same or equivalent type.
- Battery shall not be exposed to excessive heat such as sunshine, fire, or the like.

Warning:

- Do not install any battery other than CR2025 or its equivalent.
- Do not leave the remote controller in places (such as dashboards) exposed to direct sunlight for a long time.
- Store the battery in places out of reach of children.
- Do not recharge, short, disassemble, heat the battery, or dispose of it in a fire.
- Do not place the battery with other metallic materials.
- Do not poke the battery with tweezers or similar tools.
- Insulate the battery by wrapping it with tape when disposing or storing it.

KD-R538/KD-A535 is equipped with the steering wheel remote control function. For details, refer also to the instructions supplied with the remote adapter.

Menu operations



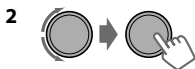

If no operation is done for about 60 seconds, the operation will be canceled.



3 Repeat step 2 if necessary.

- To return to the previous menu, press .
- To exit from the menu, press **DISP** or **MENU**.

Menu item		Selectable setting (Initial: [XX])
DEMO		For settings,  page 4.
CLOCK		
COLOR		For settings,  page 11. (KD-R538/KD-A535/KD-R530/KD-R438 only)
COLOR SETUP		
DIMMER	DIMMER SET	Selects the display and button illumination adjusted in the <BRIGHTNESS>/<COLOR SETUP> setting. [AUTO]: Changes between the Day and Night adjustments when you turn off/on the car headlights. *1 ON: Selects the Night adjustments. OFF: Selects the Day adjustments.
	BRIGHTNESS	DAY [31]/NIGHT [15]: Brightness settings for the display and button illumination for day and night. BUTTON ZONE/DISP ZONE: Sets the brightness levels 00 — 31 .
DISPLAY	SCROLL *2	[ONCE]: Scrolls the display information once. AUTO: Repeats scrolling (at 5-second intervals). OFF: Cancels.
	TAG DISPLAY	[ON]: Shows the TAG information while playing MP3/WMA tracks. OFF: Cancels.
PRO EQ		For settings,  page 12.
AUDIO	FADER *3*4	R06 — F06 [00]: Adjusts the front and rear speaker output balance.
	BALANCE *4	L06 — R06 [00]: Adjusts the left and right speaker output balance.
	LOUD (Loudness)	ON: Boosts low and high frequencies to produce a well-balanced sound at a low volume level. [OFF]: Cancels.
	VOL ADJUST (Volume adjust)	-05 — +05 [00]: Presets the volume adjustment level of each source, compared to the FM volume level. Before adjustment, select the source you want to adjust. ("VOL ADJ FIX" appears if "FM" is selected.)
	L/O MODE *5 (Line output mode)	Select if the REAR/SW terminals are used for connecting the speakers or subwoofer (through an external amplifier). SUB.W: Subwoofer [REAR]: Speakers





*1 The illumination control lead connection is required. (See "Installation/Connection Manual".) This setting may not work correctly on some vehicles (particularly on those having a control dial for dimming). In this case, change the setting to other than <DIMMER AUTO>.

*2 Some characters or symbols will not be shown correctly (or will be blanked) on the display.

*3 If you are using a two-speaker system, set the fader level to "00".

*4 This adjustment will not affect the subwoofer output.

*5 For KD-R538/KD-R530/KD-R438/KD-R430 only.

Menu item	Selectable setting (Initial: [XX])
SUB. W *6 (Subwoofer)	OFF : Cancels. [ON] : Turns on the subwoofer output.
SUB.W LPF *7 (Subwoofer low-pass filter)	LOW 55Hz/MID 85Hz/[HIGH 120Hz] : Audio signals with frequencies lower than 55 Hz/85 Hz/120 Hz are sent to the subwoofer.
SUB.W LEVEL *7 (Subwoofer level)	00 — 08 [08] : Adjusts the subwoofer output level.
AUDIO HPF *7 (High-pass filter)	ON : Activates the High Pass Filter. Low frequency signals are cut off from the front/rear speakers. [OFF] : Deactivates. (All signals are sent to the front/rear speakers.)
BEEP (Keytouch tone)	[ON]/[OFF] : Activates or deactivates the keypress tone.
TEL MUTING *8 (Telephone muting)	ON : Mutes the sounds while using the cellular phone (not connected through KS-BTA100). [OFF] : Cancels.
AMP GAIN *9 (Amplifier gain)	LOW POWER : VOLUME 00 — VOLUME 30 (Select if the maximum power of each speaker is less than 50 W to prevent damaging the speakers.) [HIGH POWER] : VOLUME 00 — VOLUME 50
SSM	For settings,  page 6. (Displayed only when the source is "FM".)
AREA (Frequency tuning interval)	[AREA US] : For North/Central/South America, AM/FM intervals: 10 kHz/200 kHz. AREA EU : For any other areas, AM/FM intervals: 9 kHz/50 kHz. AREA SA : For some South American countries, AM/FM intervals: 10 kHz/50 kHz.
TUNER MONO (Monaural mode)	Displayed only when the source is "FM". [MONO OFF] : Enables stereo FM reception. MONO ON : Improves the FM reception but stereo effect will be lost.
IF BAND (Intermediate frequency band)	[AUTO] : Increases the tuner selectivity to reduce interference noises between adjacent stations. (Stereo effect may be lost.) WIDE : Subject to interference noises from adjacent stations, but sound quality will not be degraded and the stereo effect will remain.
RADIO TIMER	For settings,  page 6.
IPOD SWITCH (iPod/iPhone control)	[HEAD MODE]/IPOD MODE/EXT MODE : For settings,  page 8. (Displayed only when the source is "USB-IPOD".) (KD-R538/KD-A535/KD-R530 only.)
SRC SELECT AM *10	[ON]/[OFF] : Enables or disables "AM" in source selection.
F-AUX *10 (Front auxiliary input)	[ON]/[OFF] : Enables or disables "F-AUX" in source selection.
R-AUX *10 (Rear auxiliary input)	ON/OFF : Enables or disables "R-AUX" in source selection. [BT ADAPTER] : Select if the rear auxiliary input jack is connected to the Bluetooth adapter, KS-BTA100 ( page 10). The source name will be changed to "BT AUDIO".

*6 Displayed only when <L/O MODE> is set to <SUB.W>.

*7 Displayed only when <SUB.W> is set to <ON>.

*8 This setting does not work if <BT ADAPTER> is selected for <R-AUX> of <SRC SELECT>.

*9 The volume level automatically changes to "VOLUME 30" if you change to <LOW POWER> with the volume level set to higher than "VOLUME 30".

*10 Displayed only when the unit is in any source other than the corresponding source "AM/F-AUX/R-AUX/BT AUDIO".

Additional information

About discs

This unit can only play the following CDs:



This unit can play back multi-session discs; however, unclosed sessions will be skipped during playback.

Unplayable discs

- Discs that are not round.
- Discs with coloring on the recording surface or discs that are dirty.
- Recordable/ReWritable disc that has not been finalized. (For details on disc finalization, refer to your disc writing software and your disc recorder instruction manual.)
- 8 cm (3 inch) CD. Attempting to insert using an adapter can cause malfunction. There may also be problems ejecting the disc if inserted.

Handling discs

- Do not touch the recording surface of the disc.
- Do not stick tape etc. on the disc, or use a disc with tape stuck on it.
- Do not use any accessories for the disc.
- Clean from the center of the disc and move outwards.
- Clean the disc with a dry silicon or soft cloth. Do not use any solvents.
- When removing discs from this unit, pull them out horizontally.
- Remove any burrs from the center hole and disc edge before inserting a disc.

DualDisc playback

The Non-DVD side of a “DualDisc” does not comply with the “Compact Disc Digital Audio” standard. Therefore, the use of Non-DVD side of a DualDisc on this product may not be recommended.

About audio files

Playable files

- File extensions: MP3(.mp3), WMA(.wma)
- Bit rate:
MP3: 8 kbps - 320 kbps
WMA: 32 kbps - 192 kbps

- Sampling frequency:
MP3: 48 kHz, 44.1 kHz, 32 kHz, 24 kHz, 22.05 kHz, 16 kHz, 12 kHz, 11.025 kHz, 8 kHz
WMA: 48 kHz, 44.1 kHz, 32 kHz
- Variable bit rate (VBR) files. (The elapsed time for VBR files will not be displayed correctly.)

Unplayable files

- MP3 files:
 - encoded in MP3i and MP3 PRO format
 - encoded in an inappropriate format
 - encoded with Layer 1/2
- WMA files:
 - encoded in lossless, professional, and voice format
 - not based upon Windows Media® Audio
 - copy-protected with DRM
- Files which include data such as AIFF, ATRAC3, etc.

Maximum number of characters for file/folder name

Varies depending on the disc format used (includes 4 extension characters—<.mp3> or <.wma>).

- ISO 9660 Level 1 and 2: 64 characters
- Romeo: 64 characters
- Joliet: 32 characters
- Windows long file name: 64 characters

Others

- This unit can show WMA Tag and ID3 Tag Version 1.0/1.1/2.2/2.3/2.4 (for MP3).
- The search function works but search speed is not constant.

About USB device

- When connecting a USB cable, use the USB 2.0 cable.
- You cannot connect a computer or portable HDD to the USB input terminal of the unit.
- Connect only one USB device to the unit at a time. Do not use a USB hub.
- USB devices equipped with special functions such as data security functions cannot be used with the unit.
- Do not use a USB device with 2 or more partitions.
- This unit cannot recognize a USB device whose rating is other than 5 V and exceeds 1 A.

- This unit may not recognize a memory card inserted into the USB card reader.
- This unit may not play back files in a USB device properly when using a USB extension cord.
- Depending on the shape of the USB devices and connection ports, some USB devices may not be attached properly or the connection might be loose.
- Operation and power supply may not work as intended for some USB devices.
- The maximum number of characters for:
 - Folder names: 63 characters
 - File names: 63 characters
 - MP3 Tag: 60 characters
 - WMA Tag: 60 characters
- This unit can recognize a total of 65 025 files, 255 folders (255 files per folder including folder without unsupported files), and of 8 hierarchies.

Cautions

- Do not pull out and attach the USB device repeatedly while "READING" is shown on the display.
- Electrostatic shock at connecting a USB device may cause abnormal playback of the device. In this case, disconnect the USB device then reset this unit and the USB device.
- Do not leave a USB device in the car, expose to direct sunlight, or high temperature. Failure to do so may result in deformation or cause damages to the device.

About iPod/iPhone

- iPod/iPhone that can be connected to this unit:
 - iPod touch (4th generation)
 - iPod touch (3rd generation)
 - iPod touch (2nd generation)
 - iPod touch (1st generation)
 - iPod classic
 - iPod with video (5th generation)*
 - iPod nano (6th generation)
 - iPod nano (5th generation)
 - iPod nano (4th generation)
 - iPod nano (3rd generation)
 - iPod nano (2nd generation)
 - iPod nano (1st generation)*
 - iPhone 4
 - iPhone 3GS
 - iPhone 3G
 - iPhone
- *<IPOD MODE>/<EXT MODE> are not applicable.

- It is not possible to browse video files on the "Videos" menu in <HEAD MODE>.
- The song order displayed on the selection menu of this unit may differ from that of the iPod.
- When operating an iPod/iPhone, some operations may not be performed correctly or as intended. In this case, visit the following JVC website: <<http://www.jvc.jp/english/car/index.html>> (English website only).

Trademark and licence notice

- Microsoft and Windows Media are either registered trademarks or trademarks of Microsoft Corporation in the United States and/or other countries.
- "Made for iPod" and "Made for iPhone" mean that an electronic accessory has been designed to connect specifically to iPod, or iPhone, respectively, and has been certified by the developer to meet Apple performance standards. Apple is not responsible for the operation of this device or its compliance with safety and regulatory standards. Please note that the use of this accessory with iPod, or iPhone may affect wireless performance.
- iPhone, iPod, iPod classic, iPod nano, and iPod touch are trademarks of Apple Inc., registered in the U.S. and other countries.
- PANDORA, the PANDORA logo, and the Pandora trade dress are trademarks or registered trademarks of Pandora Media, Inc., used with permission.

Troubleshooting

Symptom	Remedy/Cause	
General		
No sound, sound interrupted or static noise.	<ul style="list-style-type: none"> • Check the cords, antenna and cable connections. • Check the condition of the disc, connected device and recorded tracks. 	
"MISWIRING CHK WIRING THEN RESET UNIT"/"WARNING CHK WIRING THEN RESET UNIT" appears on the display and no operations can be done.	Ensure the terminals of the speaker leads are properly insulated with tape before resetting the unit. (☞ page 3) If the message does not disappear, consult your JVC car audio dealer or kits supplying company.	
The unit does not work at all.	Reset the unit. (☞ page 3)	
Source cannot be selected.	Check the <SRC SELECT> setting. (☞ page 15)	
The correct characters are not displayed (e.g. album name).	This unit can only display letters (upper case), numbers, and a limited number of symbols.	
FM/AM		
SSM automatic presetting does not work.	Store stations manually.	
CD/USB/iPod/iPhone		
"PLEASE" and "EJECT" appear alternately on the display.	Press [▲], then insert the disc correctly.	
"IN DISC" appears on the display.	The disc cannot be ejected properly. Make sure nothing is blocking the loading slot.	
"READING" keeps flashing on the display.	<ul style="list-style-type: none"> • A longer readout time is required. Do not use too many hierarchical levels and folders. • Reload the disc or reattach the USB device. 	
Tracks/folders are not played back in the order you have intended.	The playback order is determined by the file name (USB) or the order in which files were recorded (disc).	
The elapsed playing time is not correct.	This sometimes occurs during playback. This is caused by how the tracks are recorded on the disc.	
"NOT SUPPORT" appears on the display and track skips.	Check whether the track is a playable file format.	
<ul style="list-style-type: none"> • "CANNOT PLAY" flashes on the display. • The unit cannot detect the connected device. 	<ul style="list-style-type: none"> • Check whether the connected device is compatible with this unit. (USB: ☞ page 19) (iPod/iPhone: ☞ page 17) • Ensure that the device contains files in the supported formats. (☞ page 16) • Reattach the device. 	
The iPod/iPhone does not turn on or does not work. *1	<ul style="list-style-type: none"> • Check the connection between this unit and iPod/iPhone. • Detach and reset the iPod/iPhone using hard reset. For details on resetting the iPod/iPhone, refer to the instruction manual supplied with the iPod/iPhone. • Check whether <IPOD SWITCH> setting is appropriate. (☞ page 8) 	
Pandora®*2	"CANNOT SKIP"	The skip limit has been reached.
	"NO STATION"	No registered station in your iPod/iPhone.
	"NO ACTIVE STATION"	No active station.
	"SET UP PANDORA ON YOUR DEVICE"	Pandora® setup is not completed. Connect the iPod/iPhone to this unit after completing the setup in your iPod/iPhone.

*1 For KD-R538/KD-A535/KD-R530 only.

*2 For KD-A535/KD-R530 only.

Specifications

AUDIO AMPLIFIER SECTION

Power Output	20 W RMS x 4 Channels at 4Ω and ≤ 1% THD+N	
Load Impedance	4Ω (4Ω to 8Ω allowance)	
Frequency Response	40 Hz to 20 000 Hz	
Signal-to-Noise Ratio	80 dBA (reference: 1 W into 4Ω)	
Line-Out, Subwoofer-Out Level/Impedance	2.5 V/20 kΩ load (full scale)	
Output Impedance	≤ 600Ω	

TUNER SECTION

FM	Frequency Range	200 kHz step: 87.9 MHz to 107.9 MHz 50 kHz step: 87.5 MHz to 108.0 MHz
	Usable Sensitivity	9.3 dBf (0.8 μV/75Ω)
	50 dB Quieting Sensitivity	16.3 dBf (1.8 μV/75Ω)
	Alternate Channel Selectivity (400 kHz)	65 dB
	Frequency Response	40 Hz to 15 000 Hz
	Stereo Separation	40 dB
AM	Frequency Range	10 kHz step: 530 kHz to 1 700 kHz 9 kHz step: 531 kHz to 1 611 kHz
	Sensitivity/Selectivity	20 μV/40 dB

CD PLAYER SECTION

Signal Detection System	Non-contact optical pickup (semiconductor laser)
Number of Channels	2 channels (stereo)
Frequency Response	5 Hz to 20 000 Hz
Signal-to-Noise Ratio	98 dB
Wow and Flutter	Less than measurable limit

USB SECTION

USB Standard	USB 1.1, USB 2.0
Data Transfer Rate (Full Speed)	Max. 12 Mbps
Compatible Device	Mass storage class
Compatible File System	FAT 32/16/12
Playable Audio Format	MP3/WMA
Maximum Supply Current	DC 5 V = 1 A

GENERAL

Power Requirement (Operating Voltage)	DC 14.4 V (11 V to 16 V allowance)	
Grounding System	Negative ground	
Allowable Operating Temperature	0°C to +40°C (32°F to 104°F)	
Dimensions (W × H × D) (approx.)	Installation Size	182 mm × 52 mm × 158 mm (7-3/16" × 2-1/16" × 6-1/4")
	Panel Size	188 mm × 59 mm × 14 mm (7-7/16" × 2-3/8" × 9/16")
Mass	1.2 kg (2.7 lbs) (excluding accessories)	

Subject to changes without notice.



Having TROUBLE with operation?

Please reset your unit

Refer to page of How to reset your unit

Still having trouble??

USA ONLY

Call 1-800-252-5722

<http://www.jvc.com>

We can help you!

JVC

 EN, SP, FR

© 2011 JVC KENWOOD Corporation

0911DTSSANJEIN

WARNINGS / ADVERTENCIAS / AVERTISSEMENTS

- Mounting and wiring this product requires skills and experience. For safety's sake, leave this work to professionals. If you experience problems during installation, consult your JVC car audio dealer.
- The unit can only be installed in a car with a 12 V DC power supply, negative ground.
- Disconnect the battery's negative terminal and make all electrical connections before installing the unit.
- Connect speakers with a maximum power of more than 50 W (impedance of 4 Ω to 8 Ω). Otherwise, change the <AMP GAIN> setting. (See page 15 of the INSTRUCTIONS.)
- Insulate unconnected wires with vinyl tape or other similar material. To prevent a short circuit, do not remove the caps on the ends of the unconnected wires or the terminals.
- If the fuse blows, first make sure the wires are not touching to cause a short circuit, then replace the old fuse with one that has the same rating.
- Install this unit in the console of your vehicle.
- Mount the unit so that the mounting angle is 30° or less.
- Be sure to ground this unit to the car's chassis again after installation.
- After the unit is installed, check whether the brake lamps, blinkers, wipers, etc. on the car are working properly.
- Do not touch the metal part of this unit during and shortly after the use of the unit. Metal part such as the heat sink and enclosure become hot.

- La instalación y cableado de este producto requiere de habilidad y experiencia. Por motivos de seguridad, deja la labor de instalación y montaje en manos de profesionales. Si experimenta problemas durante la instalación, póngase en contacto con su distribuidor de equipos de audio para automóvil JVC.
- La unidad puede instalarse solamente en un automóvil con fuente de alimentación de 12 V CC, negativo a masa.
- Desconecte el terminal negativo de la batería y realice todas las conexiones eléctricas antes de instalar la unidad.
- Conecte los altavoces con una potencia máxima de más de 50 W (impedancia de 4 Ω a 8 Ω). De lo contrario, cambie el ajuste <AMP GAIN>. (Véase la página 15 del MANUAL DE INSTRUCCIONES).
- Aíse los cables no conectados con cinta de vinilo u otro material similar. Para prevenir los cortocircuitos, no quite las tapas de los extremos de los cables o terminales no conectados.
- Si se funde un fusible, asegúrese primero de que los cables no estén en contacto pues pueden ocasionar un cortocircuito, luego reemplace el fusible dañado por otro de las mismas características.
- Instale esta unidad en la consola de su vehículo.
- Instale la unidad en un ángulo de montaje de 30° o menos.
- Asegúrese de volver a conectar a masa esta unidad al chasis del automóvil después de la instalación.
- Después de haber instalado la unidad, compruebe que las luces de freno, los intermitentes, los limpiaparabrisas, etc. del automóvil funcionan correctamente.
- No toque la parte metálica de esta unidad durante e inmediatamente después de usar la unidad. Las partes metálicas tal como el dissipador de calor y la carcasa estarán calientes.

- Le montage et le câblage de ce produit nécessitent des compétences et de l'expérience. Pour des raisons de sécurité, laissez un professionnel effectuer le travail de montage et de câblage. Si vous rencontrez des problèmes durant l'installation, consultez votre revendeur d'autoradio JVC.
- L'appareil peut uniquement être installé dans une voiture avec une alimentation de 12 V CC, à masse négative.
- Déconnectez la borne négative de la batterie et réalisez toutes les connexions avant d'installer l'appareil.
- Connectez des enceintes avec une puissance maximum de 50 W (impédance de 4 Ω à 8 Ω). Sinon, changez le réglage <AMP GAIN>. (Voir la page 15 du MANUEL D'INSTRUCTIONS.)
- Isolez les câbles non-connectés avec un ruban de vinyle ou d'un autre matériel similaire. Pour éviter les courts-circuits, ne retirez pas non plus les capuchons à l'extrémité des câbles non-connectés ou des prises.
- Si un fusible saute, assurez-vous d'abord que les câbles n'ont pas causé de court-circuit puis remplacez le vieux fusible par un nouveau de même valeur.
- Installez cet appareil dans la console de votre véhicule.
- Monter l'unité de façon à ce que l'angle de montage soit de 30° ou moins.
- Assurez-vous de raccorder de nouveau la mise à la masse de cet appareil au châssis de la voiture après l'installation.
- Après avoir installé l'appareil, vérifiez si les lampes de frein, les indicateurs, les clignotants, etc. de la voiture fonctionnent correctement.
- Ne touchez pas la partie métallique de cet appareil pendant ou juste après son utilisation. Les parties métalliques, comme le dissipateur de chaleur et le boîtier, deviennent chaudes.

PRECAUTIONS on power supply and speaker connections

- DO NOT connect the speaker leads of the power cord to the car battery; otherwise, the unit will be seriously damaged.
- BEFORE connecting the speaker leads of the power cord to the speakers, check the speaker wiring in your car.

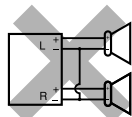

PRECAUCIONES sobre las conexiones de la fuente de alimentación y de los altavoces

- NO conecte los conductores de altavoz del cable de alimentación a la batería de automóvil, pues podrían producirse graves daños en la unidad.
- ANTES de conectar a los altavoces los conductores de altavoz del cable de alimentación, verifique el conexionado de altavoz de su automóvil.

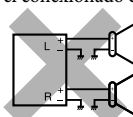

PRECAUTIONS sur l'alimentation et la connexion des enceintes

- NE CONNECTEZ PAS les fils d'enceintes du cordon d'alimentation à la batterie; sinon, l'appareil serait sérieusement endommagé.
- AVANT de connecter les fils d'enceintes du cordon d'alimentation aux enceintes, vérifiez le câblage des enceintes de votre voiture.

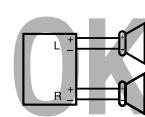

INSTALLATION / INSTALACION / INSTALLATION

In-dash mounting / Montaje en el tablero / Montage encastré

1 Do the required electrical connections. / Realice las conexiones eléctricas requeridas. / Réalisez les connexions électriques.

2 Install the unit at an angle of less than 30°. / Instale la unidad a un ángulo de menos de 30°. / Installez l'appareil avec un angle de moins de 30°.

3 Bend the appropriate tabs to hold the sleeve firmly in place. / Doble las lengüetas apropiadas para retener firmemente la manga en su lugar. / Tordez les languettes appropriées pour maintenir le manchon en place.

Part list / Lista de componentes / Liste de pièces

- (A) Control panel / Panel de control / Panneau de commande (x1)
- (B) Sleeve / Cubierta / Manchon (x1)
- (C) Trim plate / Placa de guarnición / Plaque d'assemblage (x1)
- (D) Power cord / Cordón de alimentación / Cordon d'alimentation (x1)
- (E) Handles / Manijas / Poignées (x2)

When installing the unit without using the sleeve / Instalación de la unidad sin utilizar la cubierta / Lors de l'installation de l'appareil sans utiliser de manchon

Flat head screws—M5 × 8 mm (M5 × 3/8") / Tornillos de cabeza plana—M5 × 8 mm (M5 × 3/8 pulgada) / Vis à tête plate—M5 × 8 mm (M5 × 3/8 pouces)*

Pocket / Compartimiento / Poche

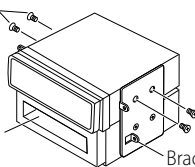

Bracket / Ménsula / Support *

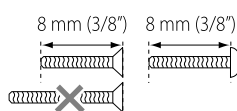

- * Not supplied for this unit.
- * No suministrado con esta unidad.
- * Non fourni avec cet appareil.

Removing the unit / Extracción de la unidad / Retrait de l'appareil

Release the rear section first... / Primero libere la sección trasera... / Ouvrez la section arrière en premier...

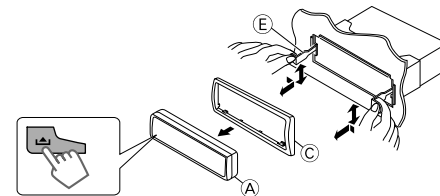

TROUBLESHOOTING / LOCALIZACION DE AVERIAS / EN CAS DE DIFFICULTES

- The fuse blows.** ⇒ Are the red and black leads connected correctly?
- Power cannot be turned on.** ⇒ Is the yellow lead connected?
- No sound from the speakers.** ⇒ Is the speaker output lead short-circuited?
- "MISWIRING CHK WIRING THEN RESET UNIT" / "WARNING CHK WIRING THEN RESET UNIT" appears on the display and no operation can be done.** ⇒ Is the speaker output lead short-circuited or touches the chassis of the car/head unit? ; Have you reset your unit?
- Sound is distorted.** ⇒ Is the speaker output lead grounded? ; Are the "-" terminals of L and R speakers grounded in common?
- Noise interfere with sounds.** ⇒ Is the rear ground terminal connected to the car's chassis using shorter and thicker cords?
- This unit becomes hot.** ⇒ Is the speaker output lead grounded? ; Are the "-" terminals of L and R speakers grounded in common?
- This unit does not work at all.** ⇒ Have you reset your unit?
- El fusible se quema.** ⇒ ¿Están los conductores rojo y negro correctamente conectados?
- No es posible conectar la alimentación.** ⇒ ¿Está el cable amarillo conectado?
- No sale sonido de los altavoces.** ⇒ ¿Está el cable de salida del altavoz cortocircuitado?
- Aparece "MISWIRING CHK WIRING THEN RESET UNIT" / "WARNING CHK WIRING THEN RESET UNIT" en la pantalla y no se puede realizar ninguna operación.** ⇒ ¿El conductor de salida de altavoz está en cortocircuito o en contacto con el chasis del automóvil/auriculares? ; ¿Reinicializó la unidad?
- El sonido presenta distorsión.** ⇒ ¿Está el cable de salida del altavoz conectado a masa? ; ¿Están los terminales "-" de los altavoces L y R conectados a una masa común?
- Perturbación de ruido.** ⇒ ¿El terminal de tierra trasero está conectado al chasis del automóvil utilizando los cordones más corto y más grueso?
- Esta unidad se calienta.** ⇒ ¿Está el cable de salida del altavoz conectado a masa? ; ¿Están los terminales "-" de los altavoces L y R conectados a una masa común?
- Esta unidad no funciona en absoluto.** ⇒ ¿Reinicializó la unidad?
- Le fusible saute.** ⇒ Les fils rouge et noir sont-ils raccordés correctement?
- L'appareil ne peut pas être mise sous tension.** ⇒ Le fil jaune est-elle raccordée?
- Pas de son des enceintes.** ⇒ Le fil de sortie d'enceinte est-il court-circuité?
- "MISWIRING CHK WIRING THEN RESET UNIT" / "WARNING CHK WIRING THEN RESET UNIT" apparaît sur l'affichage et aucune opération ne peut être réalisée.** ⇒ Est-ce qu'un fil de sortie d'enceinte est court-circuité ou touche le châssis de la voiture/appareil principal? ; Avez-vous réinitialisé votre appareil?
- Le son est déformé.** ⇒ Le fil de sortie d'enceinte est-il à la masse? ; Les bornes "-" des enceintes gauche et droit sont-elles mises ensemble à la masse?
- Intéférence avec les sons.** ⇒ La prise arrière de mise à la terre est-elle connectée au châssis de la voiture avec un cordon court et épais?
- Cet appareil devient chaud.** ⇒ Le fil de sortie d'enceinte est-il à la masse? ; Les bornes "-" des enceintes gauche et droit sont-elles mises ensemble à la masse?
- Cet appareil ne fonctionne pas du tout.** ⇒ Avez-vous réinitialisé votre appareil?

ELECTRICAL CONNECTIONS / CONEXIONES ELECTRICAS / RACCORDEMENTS ELECTRIQUES

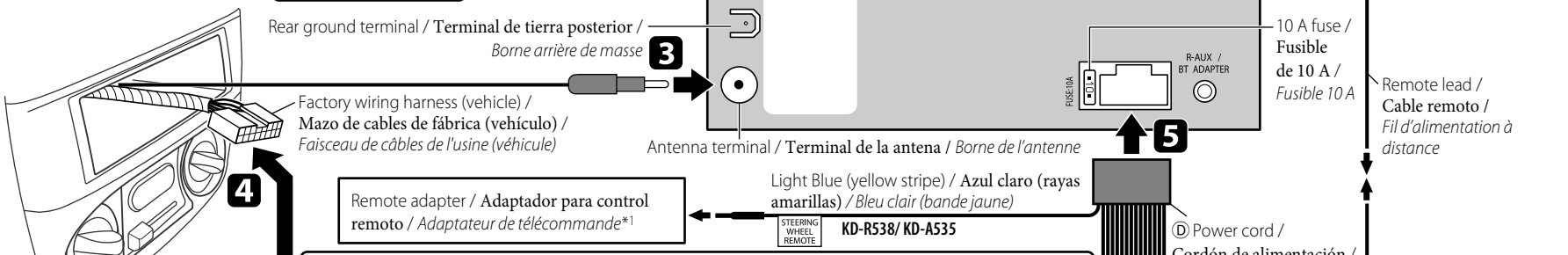
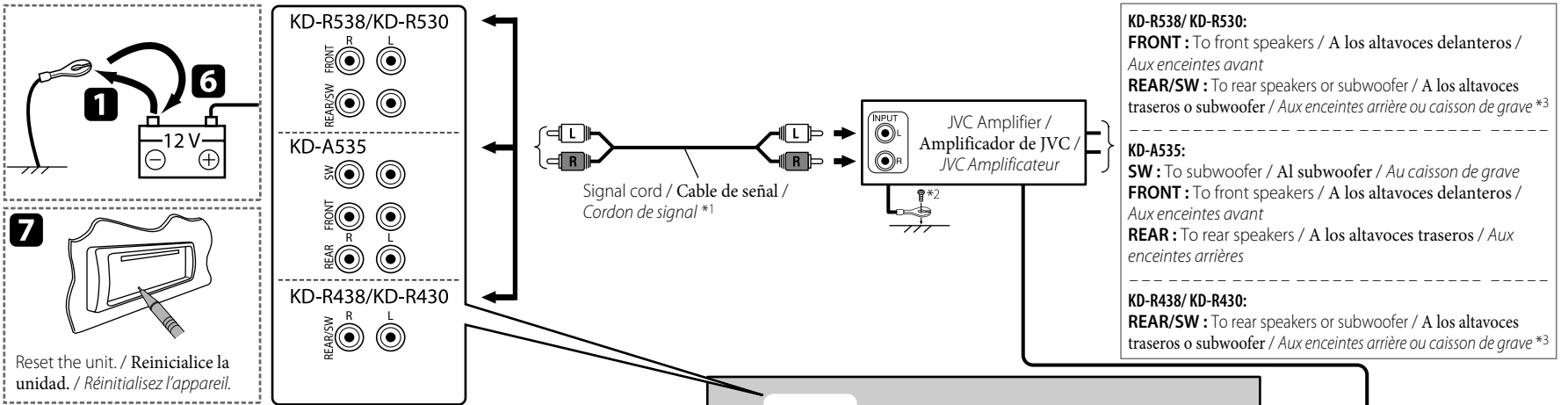

Caution / Precaución / Précautions
 Join the same color leads together. / Junte los cables del mismo color. / Joignez les fils de même couleur ensemble.
 To join the open-ends of the leads: / Para juntar los extremos abiertos de los cables: / Pour joindre les extrémités des fils:

1	Strip lead ends / Pele los extremos de los cables / Dénudez les extrémités des fils	3	Solder / Suelde / Soudez
2	Twist ends together / Retuerza los extremos conjuntamente / Torsadez les extrémités ensemble	4	Tape / Cinta / Ruban adhésif

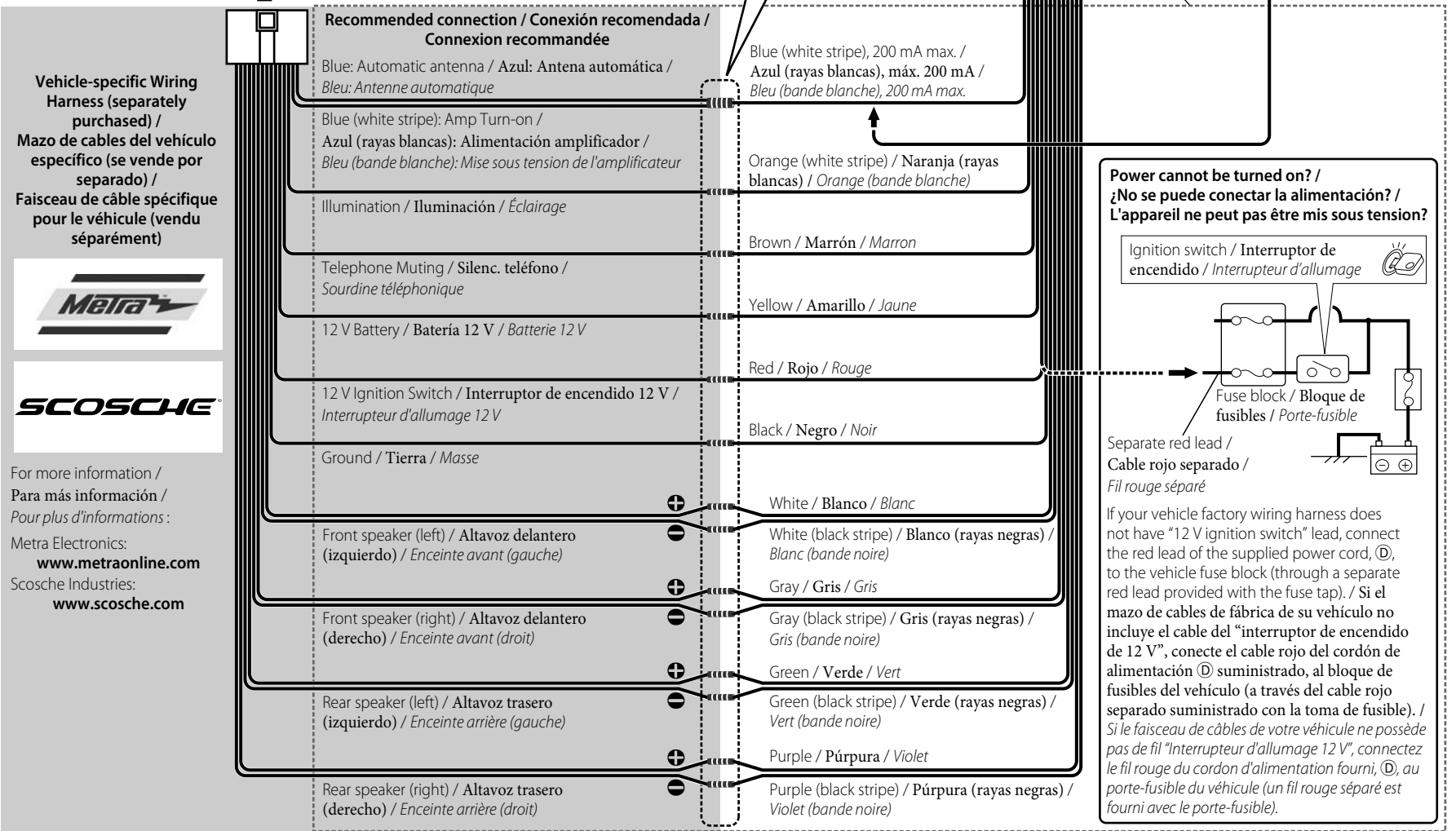

Connecting the Bluetooth adapter or portable audio player / Conexión del adaptador Bluetooth o del reproductor de audio portátil / Connexion de l'adaptateur Bluetooth ou d'un lecteur audio portable

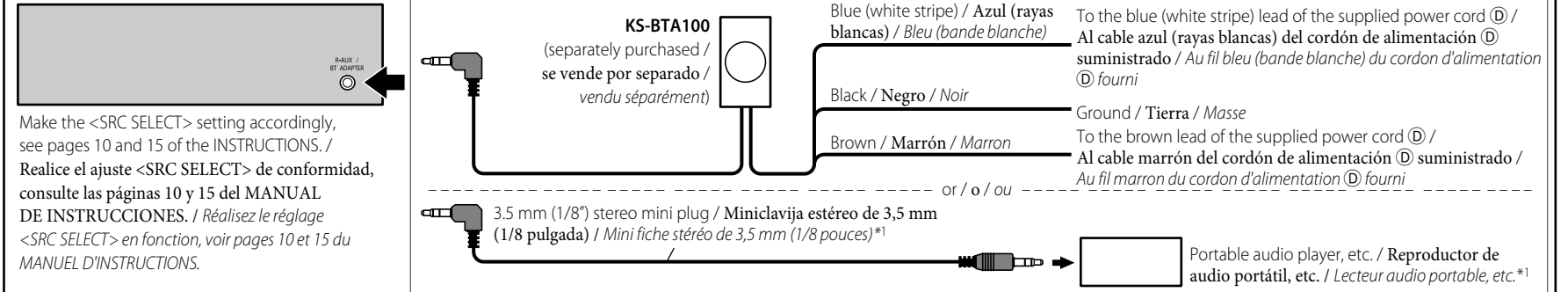

*1 Not supplied for this unit. / *1 No suministrado con esta unidad.
 *2 Firmly attach the ground wire to the metallic body or to the chassis of the car—to the place uncoated with paint. / *2 Fije firmemente el cable de tierra a la carrocería metálica o al chasis—a un lugar no cubierto con pintura.
 *3 Make the <L/O MODE> setting accordingly, see page 14 of the INSTRUCTIONS. (KD-R538/KD-R530/KD-R438/KD-R430 only) / *3 Realice el ajuste <L/O MODE> de conformidad, consulte la página 14 del MANUAL DE INSTRUCCIONES. (solo KD-R538/KD-R530/KD-R438/KD-R430 únicamente)

WHEN IT IS NOT REQUIRED
TO DETACH THE FRONT CONTROL
PANEL FROM THE MAIN UNIT,
USE THE PROVIDED SCREW TO
ATTACH THE CONTROL PANEL TO
THE MAIN UNIT.

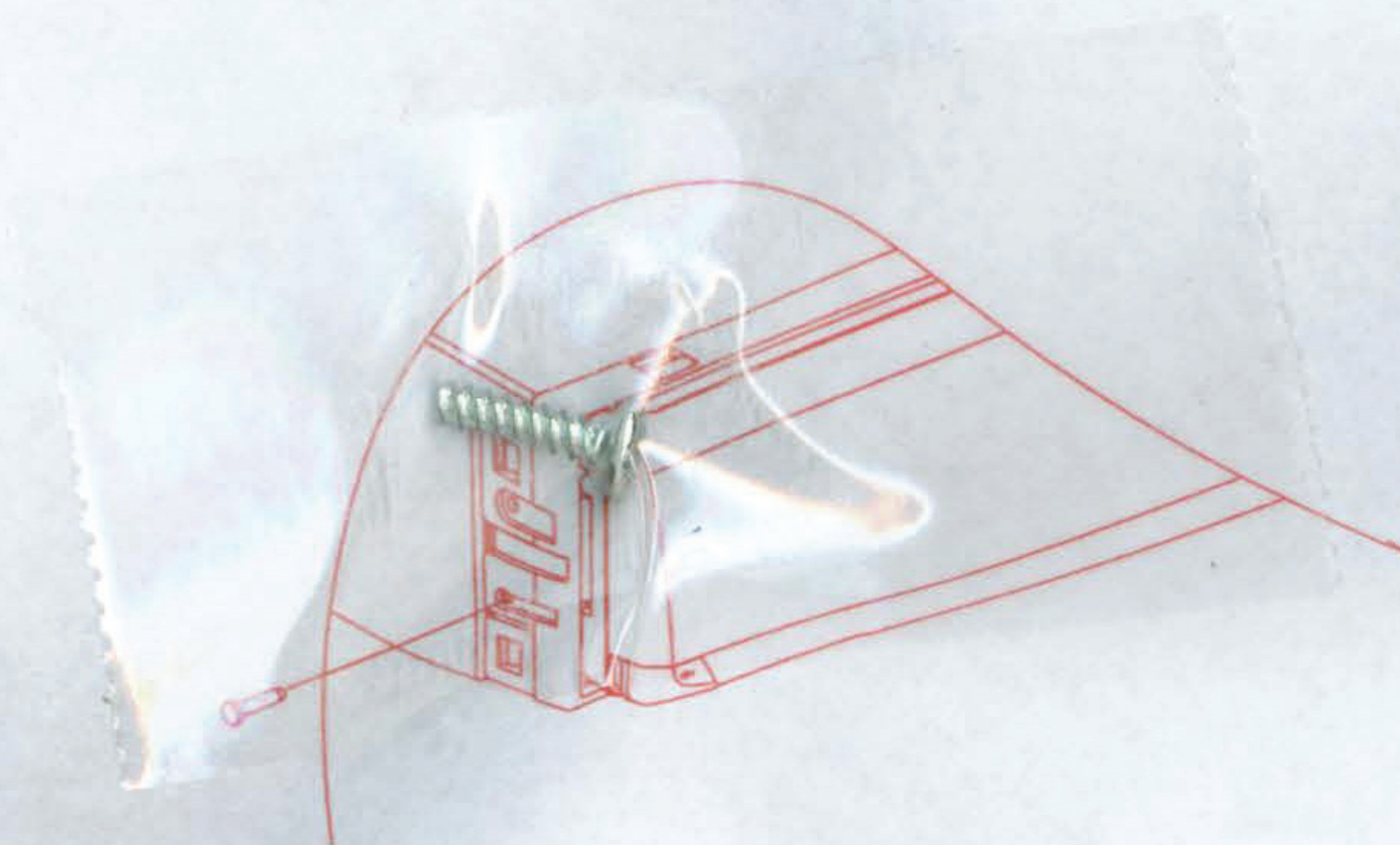

GE40401-001A

**REMOVE THIS LABEL FROM CABLE BEFORE USE.
RETIRE LA ETIQUETA DEL CABLE ELÉCTRICO ANTES DE USAR.
RETIREZ CETTE ÉTIQUETTE DU CÂBLE AVANT UTILISATION.**



CAUTION

CONNECT BLACK WIRE (① GND) TO GROUND FIRST. OTHERWISE, DAMAGE TO YOUR UNIT MAY OCCUR.

**INCORRECT CONNECTION CAUSES SERIOUS DAMAGE TO THIS UNIT
PLEASE READ INSTALLATION/CONNECTION MANUAL CAREFULLY.**

①

CONNECT GROUND FIRST

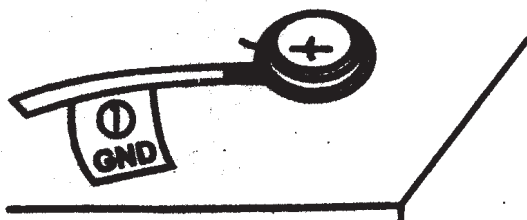

**METALLIC BODY OR CHASSIS
OF THE CAR**

②

CONNECT OTHER WIRES

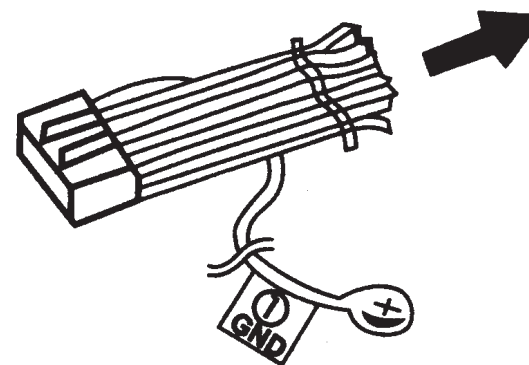

③

CONNECT ANTENNA TERMINAL

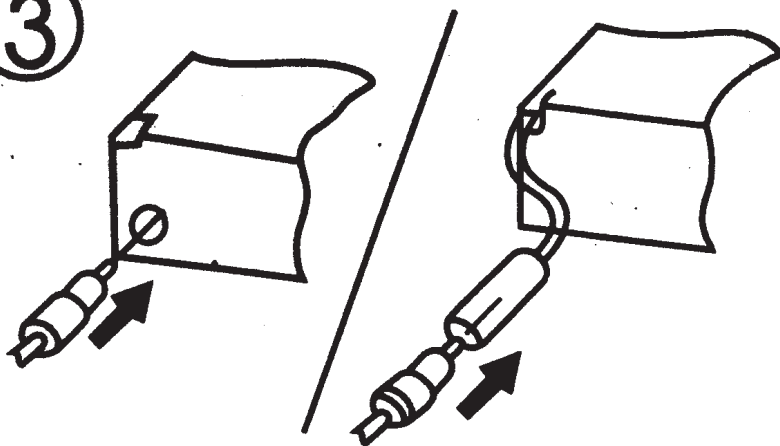

④

**CONNECT POWER CORD TO
THE UNIT**

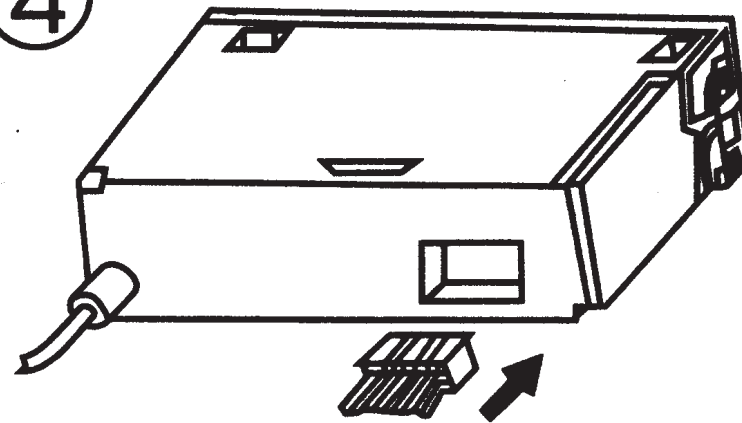

Please do not send products or other
correspondence to this address.

JVC AMERICAS CORP.
1700 Valley Road
Wayne, NJ 07470



PLEASE
PLACE
STAMP
HERE

JVC[®]

PO BOX 1189
BEDFORD, TX 76095-1189



PRODUCT REGISTRATION CARD / QUESTIONNAIRE

USA CUSTOMERS ONLY

Registering your product will allow us to contact you in the unlikely event a product safety notification is required.

This form is for Product Registration purposes only. Failure to return this form does not diminish your rights during the warranty period.

THANK YOU FOR PURCHASING THIS JVC PRODUCT

REGISTER ONLINE AT: *REGISTER.JVC.COM*



PRODUCT REGISTRATION

First Name: _____

Last Name: _____

Address: _____

Apt.# _____

City: _____

State: _____

Zip Code: _____

Phone Number: _____

E-Mail Address: _____

- | | | |
|---|-----|----|
| 1) Would you like to receive the JVC Community e-mail newsletter? | Yes | No |
| 2) Would you like to receive special offers from JVC? | Yes | No |
| 3) Have you purchased an extended warranty for this product? | Yes | No |

Date of Purchase _____

Model Number: _____

Serial Number: _____

Purchase Price: _____

Dealer: _____

On a scale of 1 to 5, with 5 being the best, please rate each of the following attributes about your new JVC product.

Performance	1	2	3	4	5
Features	1	2	3	4	5
Ease of use	1	2	3	4	5
Design	1	2	3	4	5
Value	1	2	3	4	5

COMMENTS:

Thank You
for completing
this questionnaire.

CANADA
ONLY

JVC

CANADA
SEULEMENT

OWNER'S COPY OF WARRANTY CARD COPIE D'ENREGISTREMENT DE LA GARANTIE DU PROPRIÉTAIRE

(Save sales docket together with this warranty card, as a proof of date of purchase.
La facture et cette garantie sont vos preuves de la date d'achat; rangez-les.)

MODEL : SERIAL NO. :
MODÈLE : NO DE SÉRIE :

Purchase from : Date purchased :
Acheté chez : Date acheté :

Dealer's Address :
Adresse du Vendeur :

No. Street No. Apt.
No. Rue App.

City or Town Prov. Postal Code
Ville Prov. Code Postal

Owner's Name
Nom du Propriétaire :

Owner's Address
Adresse du Propriétaire :

No. Street No. Apt.
No. Rue App.

City or Town Prov. Postal Code
Ville Prov. Code Postal

BT-52008-1
(1007)

Detach here.

à découper ici

Printed in Indonesia

WARRANTY CONTROL CARD CARTE DE CONTRÔLE DE LA GARANTIE

IMPORTANT: This warranty control card must be filled in and posted to the address indicated on the back hereof or register via internet within 7 (seven) days from the date of purchase.

IMPORTANT: Cette carte doit être renvoyée dûment remplie à l'adresse indiquée au verso, dans les 7 jours de la date d'achat ou aller sur le site par internet pour l'enregistrement.

(PLEASE PRINT/EN LETTRES MOULÉES)

MODEL : SERIAL NO. :
MODÈLE : NO DE SÉRIE :

Purchased from : Date purchased :
Acheté chez : Date acheté :

Dealer's Address :
Adresse du Vendeur :

No. Street No. Apt.
No. Rue App.

City or Town Prov. Postal Code
Ville Prov. Code Postal

Owner's Name
Nom du Propriétaire :

Owner's Address
Adresse du Propriétaire :

No. Street No. Apt.
No. Rue App.

City or Town Prov. Postal Code
Ville Prov. Code Postal

You may also register on-line
at: www.jvc.ca

Vous pouvez également vous
inscrire par internet à: www.jvc.ca

WARRANTY APPLIES ONLY TO PRODUCT
DISTRIBUTED IN CANADA BY JVC CANADA INC.

LA GARANTIE S'APPLIQUE SEULEMENT AUX PRODUITS
DISTRIBUES AU CANADA PAR JVC CANADA INC.

Warranty applies only
to **PRODUCT** distributed
in Canada by JVC Canada
Inc.

JVC

La garantie s'applique
seulement aux **PRODUITS**
distribués au Canada par
JVC Canada Inc.

WARRANTY GARANTIE

JVC CANADA INC.

21 Finchdene Square, Toronto, ON M1X 1A7

TEL: (416) 293-1311 FAX: (416) 293-8208

<http://www.jvc.ca>

JVC CANADA INC. (hereafter called "JVC") gives the following express warranty for each new JVC product distributed in Canada by JVC and sold by an authorized JVC dealer.

JVC warrants that this JVC product is free, under normal use and maintenance, from any defects in material and workmanship subject to the following terms and conditions:

1. To Obtain Warranty Service:

- The JVC Warranty Control Card herein provided must be completed in full and posted or registered via internet within 7 days of date of purchase of the JVC product.
- This JVC Warranty Control Card must be completed in full and presented together with proof of purchase of the JVC product requiring service.
- The JVC product must be brought in for service to an authorized JVC Service Centre.

2. Limitation:

This Warranty shall not apply to:

- Repair or replacement of any cabinets, batteries, plates, connection cords, antennas, dust covers, knobs, speaker grills, speaker cones, projection screens, projection screen savers, and all accessories.
- Any defects caused or repairs required as a result of misuse, abusive operation, negligence, improper use and/or insufficient care.
- Any defect caused or repairs required as a result of not following the instructions in the operation manual.
- Any JVC product tampered with, adjusted or repaired by any party other than JVC or authorized JVC Service Centre personnel.

JVC CANADA INC. (ci-après appelé "JVC") énonce la garantie expresse suivante pour tout nouveau produit JVC distribué au Canada par JVC et vendu par un détaillant JVC autorisé.

JVC vous garantit que ce produit est dégagé, sous utilisation et entretien normal, de tout défaut matériel et de fabrication sous réserve des modalités et conditions suivantes :

1. Pour obtenir un service de garantie :

- La carte de contrôle de garantie JVC ci-incluse doit être complétée avec les renseignements complets et être postée ou enregistrée via internet dans les 7 jours suivant l'achat du produit JVC.
- Cette carte de contrôle de garantie JVC doit être dûment remplie et être présentée avec la preuve d'achat du produit JVC nécessitant une réparation.
- Le produit JVC doit être apporté pour service chez un centre de service JVC autorisé.

2. Restrictions:

Cette garantie ne s'applique pas aux :

- Réparation ou remplacement de tout cabinet, batteries, panneau avant, cordons de raccord, antennes, housses de protection, boutons, couverts de haut-parleur, cônes de haut-parleur, écrans de projection, protecteurs d'écran de projection et tous les accessoires.
- Tous défauts occasionnés ou réparations requises suite à une utilisation abusive, mauvaise, négligente et/ou une utilisation incorrecte.
- Tous défauts occasionnés ou réparations requises suite à l'omission de suivre les recommandations du manuel d'instruction.
- Tout produit JVC altéré, ajusté ou réparé par tout autre entreprise que JVC ou un centre de service d'entretien ou de service autorisé JVC.

- (e) Any JVC products on which the serial number has been defaced, modified or removed.
- (f) Maintenance, cleaning or periodic check-up
- (g) Conversion to foreign or domestic voltage or frequency.
- (h) Any JVC product without the Canadian Electrical Safety Regulations ID.
- (i) Any JVC products used for commercial or institutional, rental, or display purposes.
Parts.....1 year (except video head - 90 days)
Labour... 90 days
- (j) Any JVC product which has been resold and no longer owned by the original purchaser.
- (k) Product purchased from "outside Canada", "bankruptcy" or "liquidator".

- (e) Tout produit JVC dont le numéro de série a été altéré, modifié ou enlevé.
- (f) L'entretien, les vérifications périodiques et nettoyage.
- (g) La conversion à une fréquence ou une tension étrangère ou domestique.
- (h) Tout produit JVC n'ayant pas le sigle d'identification conforme aux normes électriques Canadiennes (CSA).
- (i) Pour tout produit utilisé à des fins commerciales, institutionnelles, de location ou utilisé à des fins d'étalage.
Pièces..... 1 An (Excepté les têtes vidéo- 90 jours)
Main d'œuvre... 90 Jours
- (j) Tout produit JVC ayant été revendu et qui n'est plus la propriété de l'acheteur original.
- (k) Produit acheté à "l'extérieur du Canada", provenant d'une "faillite" ou d'un "liquidateur".

- (l) Any defects caused by fire, flood, lightning, power surge, or other events beyond the control of JVC.
- (m) FOR AUTO PRODUCTS
Warranty does not cover elimination of car static or electrical interferences, cleaning of head, adjustments, or labour cost for the removal or reinstallation of the unit for repair.

- (l) Tout dommage causé par le feu, une inondation, un éclair, une surtension ou tout autre événement hors du contrôle de JVC.
- (m) POUR LES PRODUITS D'AUTOMOBILE
La garantie ne couvre pas l'élimination d'interférences statiques ou électriques de la voiture, le nettoyage de tête, les ajustements et les coûts de main d'œuvre associés à l'enlèvement ou à la réinstallation de l'unité pour réparation.

**WARRANTY TERM (VALID FROM THE DATE OF PURCHASE)
CONDITIONS DE GARANTIE (VALABLE à PARTIR DE LA DATE D'ACHAT)**

PRODUCT PRODUIT	PARTS (Years) PIECES (années)	Labour (Years) MAIN-D'OEUVER (années)
Projection TV In-Home Service Colour TV In-Home (25" and above) D-ILA Rear Projection In-Home Service LCD TV In-Home Service (25" and above) Écrans de projection Service à Domicile Écrans de TV Couleur Service à Domicile (25" et plus) TV projection arrière D-ILA Service à Domicile Écrans de LCD Service à Domicile (25" et plus)	1	1
<p>* In-home service to be provided where available Where it is not available, the Purchaser must assume the responsibility and expense for the proper packing, shipment and all costs associated with the delivery of the equipment to and from the closest JVC Authorized Service Centre. * Service à domicile fourni par un détaillant disponible. S'il n'y a pas de service JVC disponible à proximité, l'acheteur doit assumer la responsabilité et les coûts pour un emballage adéquat, l'expédition, ainsi que tous les coûts associés à la livraison de l'équipement chez et depuis le détaillant JVC autorisé le plus près pour un service d'entretien.</p>		
Receivers and Home Speakers purchased separately, Front Projection and Car Audio "ARSENAL" Series Récepteurs et Hauts-Parleurs achetés séparément, Projecteur Avant et Audio d'Auto de Série « ARSENAL »	2	2
AC Adapters, Remote Controls, Headphones, Microphones and Projector Lamps Adaptateurs AC, Télécommande, Casque D'écoute, Microphones et Lampe de Projecteur	90 DAYS 90 JOURS	90 DAYS 90 JOURS
Wood Cone Speakers Enceinte à Cône en Bois	5	5
All Other Categories Toutes les autres catégories	1	1

3. Standards:

If any defects should be found in a JVC product within the applicable terms, necessary repairs shall be made at no cost to the purchaser for parts or labour when JVC acknowledges that such defects are due to faulty material or workmanship.

4. Exclusion of All Other Express Warranties:

This warranty constitutes the entire express warranty given by JVC for JVC products and no dealer or service centre personnel or his, its or their agent or employee is, or are authorized to extend or enlarge this warranty on behalf of JVC.

5. Disclaimer of Consequential Damage:

To the extent the law permits JVC disclaims any responsibility for loss of time or use of its product, transportation costs, or any other indirect, incidental or consequential damage or inconvenience.

New

And mail to the address below.
**You may also register on-line
at: www.jvc.ca**

Detach here.

Nouveau

Veuillez poster à l'adresse ci-dessous.
**Vous pouvez également vous
enregistrer par internet à; www.jvc.ca**

à découper ici

**Place stamp
here
Placez votre
timbre ici**

JVC CANADA INC.

21 Finchdene Square
Toronto, ON M1X 1A7

TO OUR VALUED CUSTOMER _____

THANK YOU FOR PURCHASING THIS JVC PRODUCT.
WE WANT TO HELP YOU ACHIEVE A PERFECT EXPERIENCE.

**NEED HELP ON HOW TO HOOK UP?
NEED ASSISTANCE ON HOW TO OPERATE?
NEED TO LOCATE A JVC SERVICE CENTER?
LIKE TO PURCHASE ACCESSORIES?**

JVC[®] IS HERE TO HELP!
TOLL FREE: 1(800)252-5722
<http://www.jvc.com>

Remember to retain your Bill of Sale for Warranty Service.

_____ **Do not attempt to service the product yourself** _____

Caution

To prevent electrical shock, do not open the cabinet.
There are no user serviceable parts inside.
Please refer to qualified service personnel for repairs.



LIMITED WARRANTY

1-1 **USA ONLY**

ONLY FOR PRODUCT PURCHASED IN U.S.A.

JVC Americas Corp. (JVC) warrants this product and all parts thereof, except as set forth below ONLY TO THE ORIGINAL RETAIL PURCHASER to be FREE FROM DEFECTIVE MATERIALS AND WORKMANSHIP from the date of original purchase for the period shown below. ("The Warranty Period")

PARTS	1 YR	LABOR	1 YR
-------	-------------	-------	-------------

THIS LIMITED WARRANTY IS VALID ONLY IN THE FIFTY (50) UNITED STATES, THE DISTRICT OF COLUMBIA AND IN THE COMMONWEALTH OF PUERTO RICO.

WHAT WE WILL DO:

If this product is found to be defective within the warranty period, JVC will repair or replace defective parts with new or rebuilt equivalents at no charge to the original owner. Such repair and replacement services shall be rendered by JVC during normal business hours at JVC authorized service centers. Parts used for replacement are warranted only for the remainder of the Warranty Period. All products may be brought to a JVC authorized service center on a carry-in basis. Color televisions with a screen size of 37" class or greater qualify for in-home service. In such cases, a technician will come to your home and either repair the TV there or remove and return it if it cannot be repaired in your home.

WHAT YOU MUST DO FOR WARRANTY SERVICE:

Please do not return your product to the retailer

Instead, return your product to the JVC authorized service center nearest you. If shipping the product to the service center, please be sure to package it carefully, preferably in the original packaging, and include a brief description of the problem(s). Please call 1-800-252-5722 to locate the nearest JVC authorized service center. Service locations can also be obtained from our website <http://www.jvc.com>. If your product qualifies for in-home service, the service representative will require clear access to the product.

If you have any questions concerning your JVC Product, please contact our Customer Care Center at 800-252-5722

WHAT IS NOT COVERED:

This limited warranty provided by JVC does not cover:

1. Products which have been subject to abuse, accident, alteration, modification, tampering, negligence, misuse, faulty installation, lack of reasonable care, or if repaired or serviced by anyone other than a service facility authorized by JVC to render such service, or if affixed to any attachment not provided with the products, or if the model or serial number has been altered, tampered with, defaced or removed;
2. Initial installation, installation and removal from cabinets or mounting systems.
3. Operational adjustments covered in the Owner's Manual, normal maintenance, video and audio head cleaning;
4. Damage that occurs in shipment, due to act of God, and cosmetic damage;
5. Signal reception problems and failures due to line power surge;
6. User Removal Memory Devices/Video Pick-up Tubes/CCD Image Sensors are covered for 90 days from the date of purchase;
7. Accessories;
8. Batteries (except that Rechargeable Batteries are covered for 90 days from the date of purchase);
9. Products used for commercial purposes, including, but not limited to rental.
10. Loss of data resultant from malfunction of hard drive or other data storage device;

There are no express warranties except as listed above.

THE DURATION OF ANY IMPLIED WARRANTIES, INCLUDING THE IMPLIED WARRANTY OF MERCHANTABILITY, IS LIMITED TO THE DURATION OF THE EXPRESS WARRANTY HEREIN.

JVC SHALL NOT BE LIABLE FOR ANY LOSS OF USE OF THE PRODUCT, INCONVENIENCE, OR ANY OTHER DAMAGES, WHETHER DIRECT, INCIDENTAL OR CONSEQUENTIAL (INCLUDING, WITHOUT LIMITATION, DAMAGE TO TAPES, RECORDS OR DISCS) RESULTING FROM THE USE OF THIS PRODUCT, OR ARISING OUT OF ANY BREACH OF THIS WARRANTY. ALL EXPRESS AND IMPLIED WARRANTIES, INCLUDING THE WARRANTIES OF MERCHANTABILITY AND FITNESS FOR PARTICULAR PURPOSE, ARE LIMITED TO THE WARRANTY PERIOD SET FORTH ABOVE.

Some states do not allow the exclusion of incidental or consequential damages or limitations on how long an implied warranty lasts, so these limitations or exclusions may not apply to you. This warranty gives you specific legal rights and you may also have other rights which vary from state to state.

JVC AMERICAS CORP.

1700 Valley Road, Wayne, New Jersey 07470
<http://www.jvc.com>

REFURBISHED PRODUCTS CARRY A SEPARATE WARRANTY, THIS WARRANTY DOES NOT APPLY. FOR DETAIL OF REFURBISHED PRODUCT WARRANTY, PLEASE REFER TO THE REFURBISHED PRODUCT WARRANTY INFORMATION PACKAGED WITH EACH REFURBISHED PRODUCT.

For customer use:

Enter below the Model No. and Serial No. which is located either on the rear, bottom or side of the cabinet. Retain this information for future reference.

Model No. : _____

Serial No. : _____

Purchase date : _____

Name of dealer : _____